



Bontempi

SURGICAL INSTRUMENTS
PORTUGAL

Passion for Excellence

Veterinärchirurgie
Veterinary Surgery
Chirurgia Veterinaria
Cirugía Veterinaria
Chirurgie vétérinaire





BONTEMPI
CHIRURGISCHE INSTRUMENTE

Diagnostik, Skalpellklingen
Diagnostics, Knives and Scalpel blades
Diagnostica, Bisturi e lame
Diagnóstico, Hojas de bisturias
Diagnostic, Lames de bistouris

Mc Intosh



AA-B100
2,5 Volt
300 mA

Für Spatel **AA-100**
For blades **AA-100**
Per lama **AA-100**
Para hojas **AA-100**
Pour spatules **AA-100**



AA-B101
2,5 Volt
300 mA

Für Spatel **AA-101 ÷ AA-104**
For blades **AA-101 ÷ AA-104**
Per lama **AA-101 ÷ AA-104**
Para hojas **AA-101 ÷ AA-104**
Pour spatules **AA-101 ÷ AA-104**

Mc INTOSH

AA-S103 - Set 3 lame

AA-S104 - Set 4 lame

AA-S105 - Set 5 lame

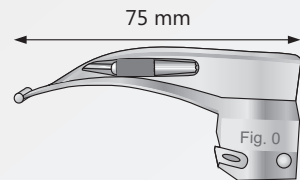

AA-100

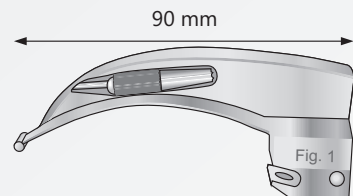

AA-101

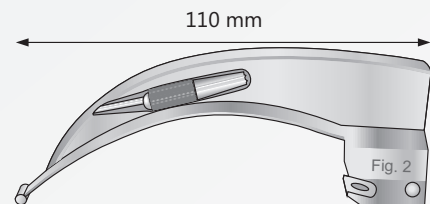

AA-102

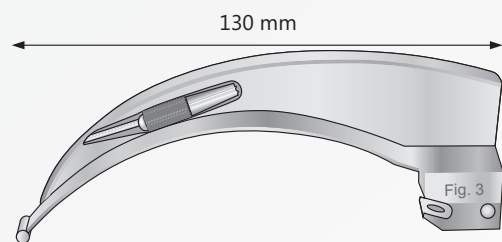

AA-103

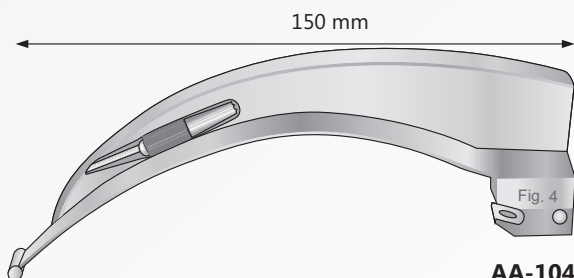

AA-104



AA-B100

2,5 Volt
300 mA

Für Spatel **AA-200 ÷ AA-203**
For blades **AA-200 ÷ AA-203**
Per lame **AA-200 ÷ AA-203**
Para hojas **AA-200 ÷ AA-203**
Pour spatules **AA-200 ÷ AA-203**



AA-B101

2,5 Volt
300 mA

Für Spatel **AA-204**
For blades **AA-204**
Per lama **AA-204**
Para hojas **AA-204**
Pour spatules **AA-204**

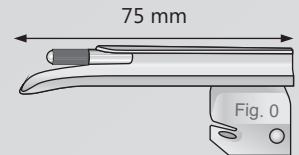

AA-200

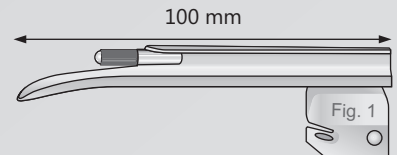

AA-201

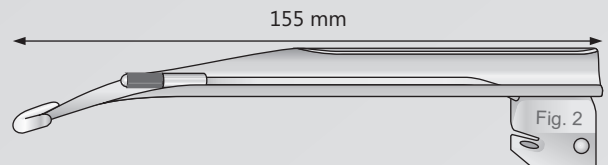

AA-202

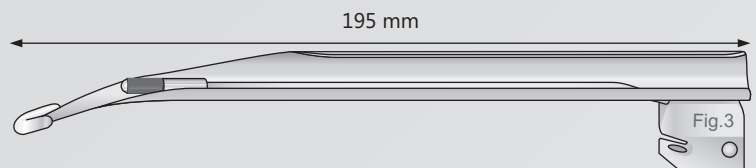

AA-203

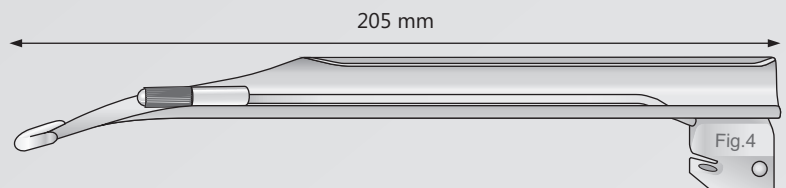

AA-204

MILLER

AA-S203 - Set 3 lame

AA-S204 - Set 4 lame

AA-S205 - Set 5 lame





Negus-Guedel



AA-B100
2,5 Volt
300 mA

Für Spatel **AA-401**
For blades **AA-401**
Per lama **AA-401**
Para hojas **AA-401**
Pour spatules **AA-401**



AA-B101
2,5 Volt
300 mA

Für Spatel **AA-402 ÷ AA-404**
For blades **AA-402 ÷ AA-404**
Per lama **AA-402 ÷ AA-404**
Para hojas **AA-402 ÷ AA-404**
Pour spatules **AA-402 ÷ AA-404**

NEGUS-GUEDEL

AA-S403 - Set 3 lame
AA-S404 - Set 4 lame

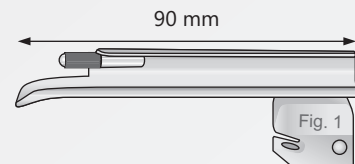

AA-401

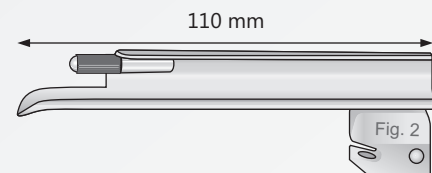

AA-402

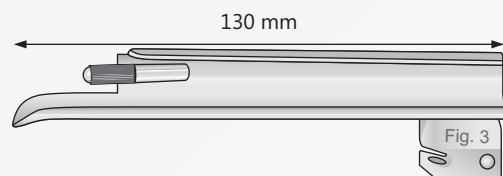

AA-403

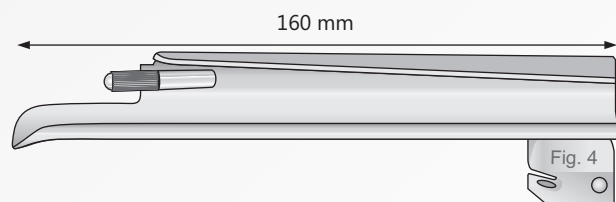

AA-404

Laryngoskope und Zubehör
Laryngoscopes and accessories
Laringoscopi e accessori
Laringoscopios y accesorios
Laryngoscopes et accessoires

Mc Intosh

Mc INTOSH

AA-S503 - Set 3 lame

AA-S504 - Set 4 lame

AA-S505 - Set 5 lame

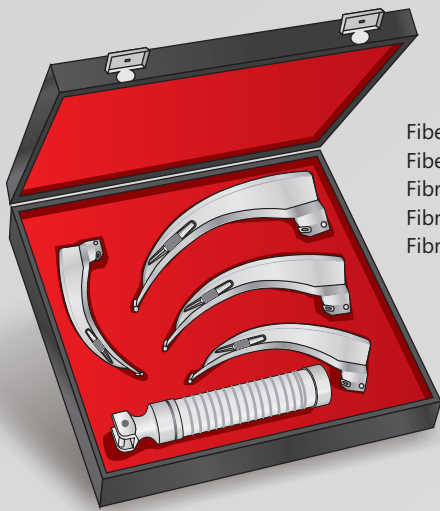

Fiberoptik
Fiber Optic
Fibre ottiche
Fibra óptica
Fibre optic

Miller

MILLER

AA-S253 - Set 3 lame

AA-S254 - Set 4 lame

AA-S255 - Set 5 lame

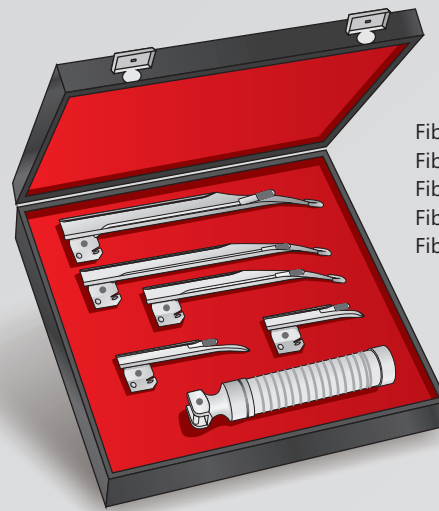

Fiberoptik
Fiber Optic
Fibre ottiche
Fibra óptica
Fibre optic

Griffe aus Rostfreiem Edelstahl
Handles of stainless steel
Manico in Acciaio Inossidabile
Manico de acero inoxidable
Manche Acier inoxydable



AA-70
Ø 30 mm

Kaltlichtgriff
Fiberoptic Handle
Manico Fibre ottiche
Mango de fibra óptica
Manche fibre optic



AA-80
Ø 18 mm



AA-90H
Ø 30 mm

Halogenlampe
Halogen lamp
Lampada alogene
Làmpara Houlógeno
Lampe halogène



AA-130
640 mA



AA-B100
2,5 Volt
300 mA



AA-B101
2,5 Volt
300 mA

Fiberoptik
Fiber Optic
Fibre ottiche
Fibra óptica
Fibre optic

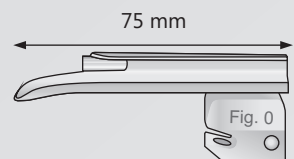

AA-250

Fiberoptik
Fiber Optic
Fibre ottiche
Fibra óptica
Fibre optic

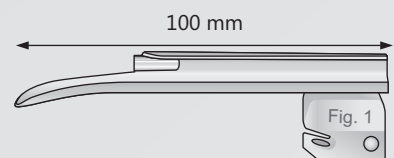

AA-251

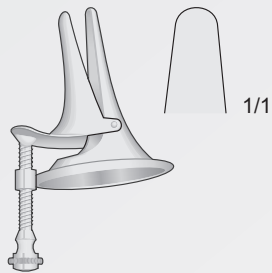

DUPLAY
AB-41R

Nasenspekulum
Nasal specula
Speculum nasale
Espéculo nasal
Spèculum nasal

Otoscopio a luce Alogena (bianca)

Composto da tre coni di varie misure
Doppia lente per una perfetta messa a fuoco
Lampadina di ricambio



GOWLLANDS
AB-46



AB-49

Otoskop komplett mit Koffer
Otoscope complete with case
Otoscopio completo con custodia
Otoscopio completo con el caso
Otoscope avec étui

Halogen
Halogen
Alogeno
Halógena
Halogène

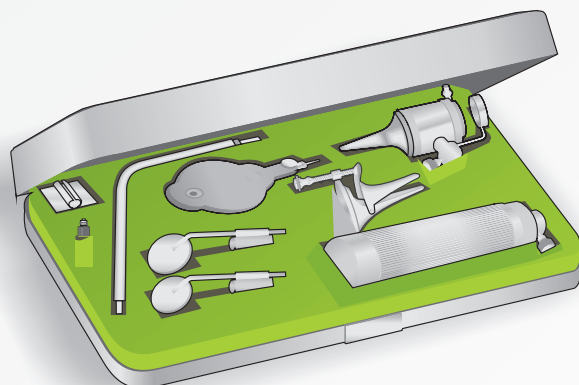

AB-41

Oto-Ophthalmoskop-Nasenspekulum und 2 Kehlkopfspiegel
Oto-Ophthalmoscope-Nasal specula and 2 Laryngeal mirror
Set oto-oftalmoscopio-speculum nasale e 2 specchietti laringei
Trousse à Oto-Ophtalmoscopie-spèculum nasal avec 2 miroirs
Set Oto-oftalmoscopio y espèculo nasal con 2 espejos laringeos

Perkussionshämmer
Percussion Hammers
Martelli percussori
Martillos de percusión
Marteaux-percuteurs

Nickel-Chrom Griffe
Nickel-Chromium Handle
Manico in Nichel-Cromo
Manija de níquel-cromo
Poignée nickel-chrome

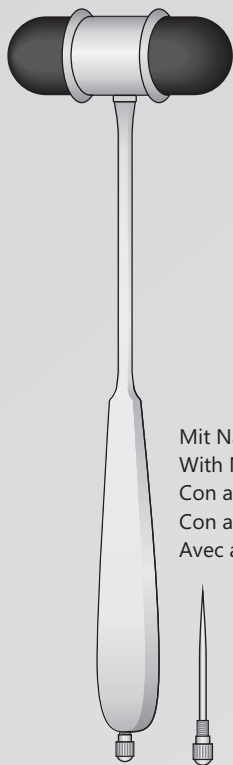

Mit Nadel
With Needle
Con ago
Con aguja
Avec aiguille

DEJERINE
AB-10
200 mm

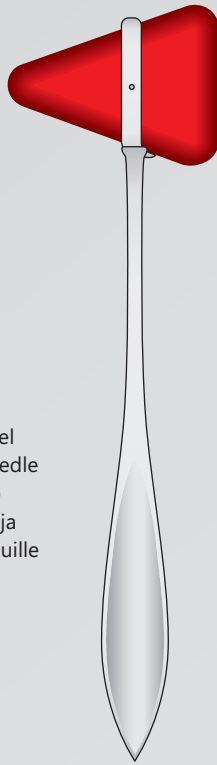

TAYLOR
AB-14
200 mm

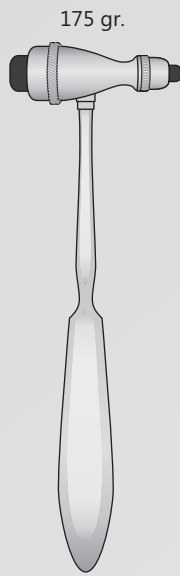

175 gr.
TROEMNER
AB-16
140 mm

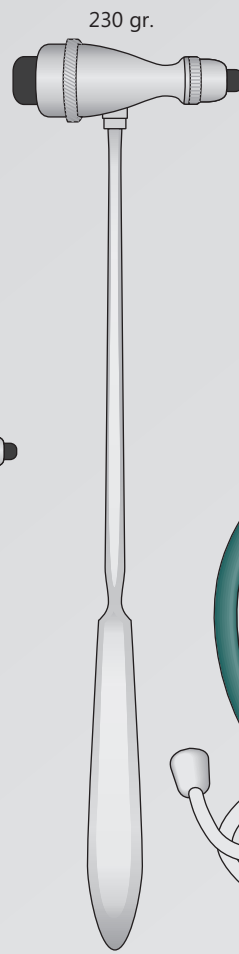

230 gr.
TROEMNER
AB-18
240 mm

Professional
Con 4 olive di ricambio



AB-50

Zungenzangen
Tongueforceps
Pinze tiralingua
Pinzas tira-lengua
Pincas tire-langue

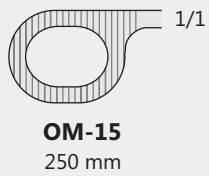
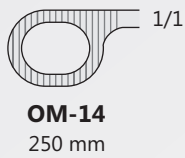

Anaesthesie
Anesthesia
Anestesia
Anestesia
Anesthésie

Kathetereinführungszangen
Catheter introducing forceps
Pinze da intubazione
Pinzas para introducir catéteres
Pincas à intubation

MAGILL
OM-12/OM-15



OM-44
1 Paar ersatzgummi
1 Pair of rubber pads
Gommini di ricambio 2 pezzi
1 Paar placas de caucho
1 Paire de mors caoutchouc

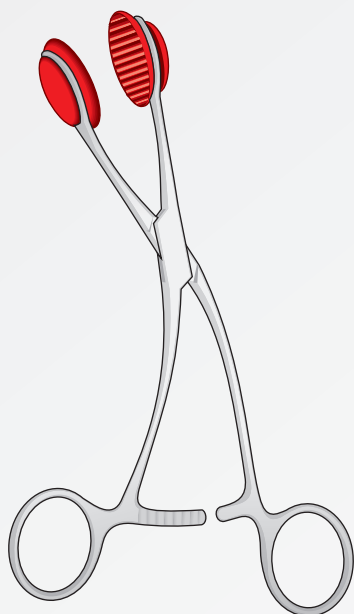

YOUNG
OM-45
160 mm



OM-47
1 Paar ersatzgummi
1 Pair of rubber pads
Gommini di ricambio 2 pezzi
1 Paar placas de caucho
1 Paire de mors caoutchouc

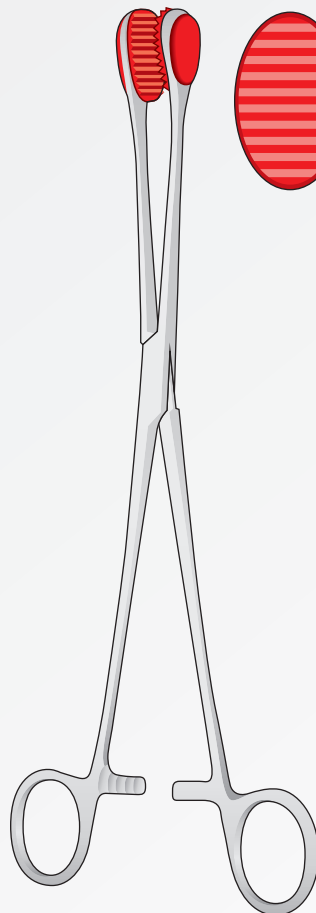

CHILD
OM-46
240 mm

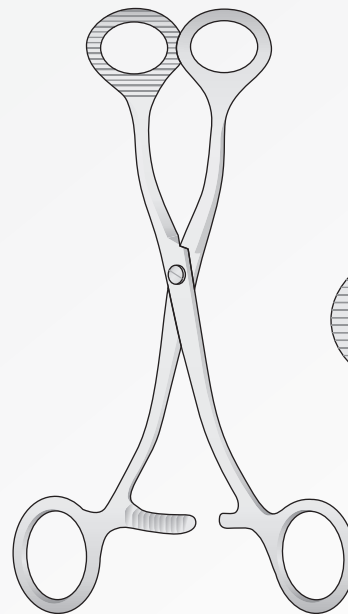

COLLIN
OM-10/OM-30

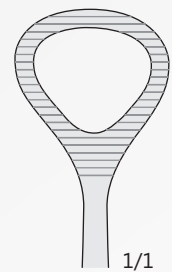

OM-30
165 mm

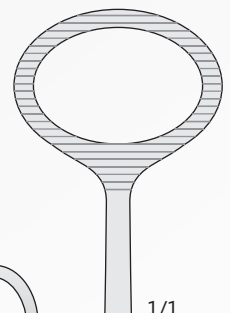

OM-10
170 mm

Skalpelle
Knives
Bisturi
Bisturies
Bistouris

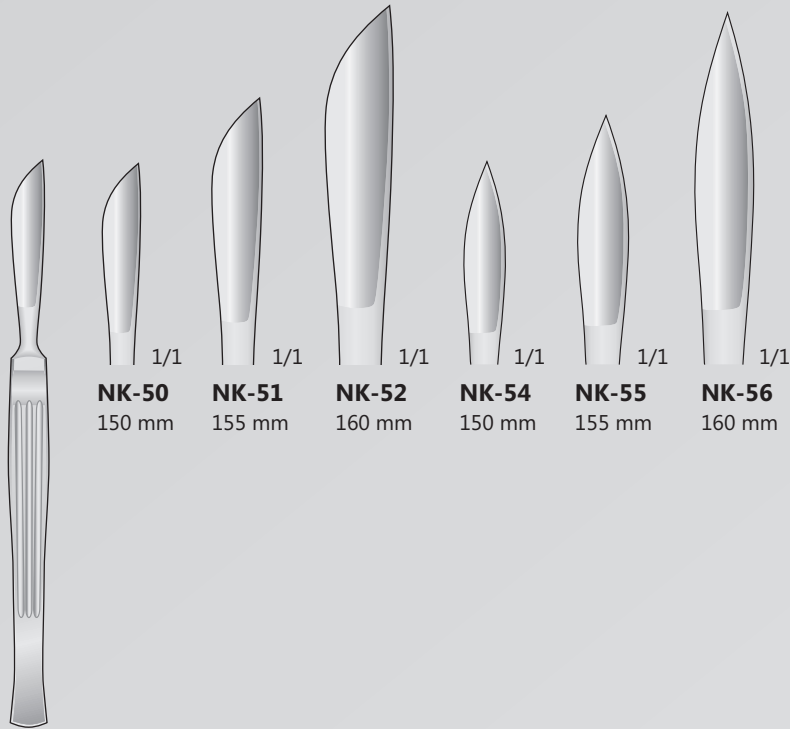

NK-50 150 mm
NK-51 155 mm
NK-52 160 mm
NK-54 150 mm
NK-55 155 mm
NK-56 160 mm

NK-50/NK-56

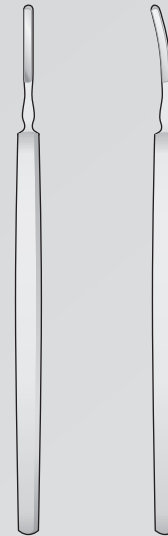

DESMARRES
NK-95 135 mm
DESMARRES
NK-96 135 mm

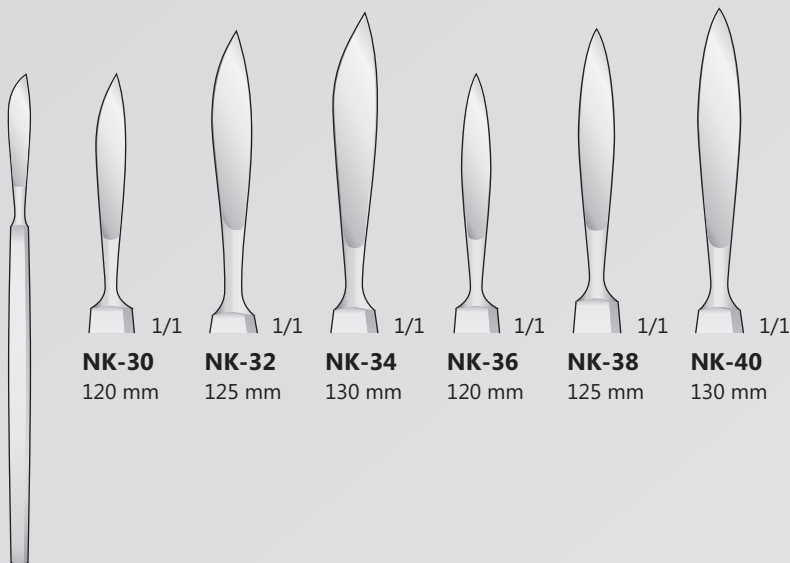

NK-30 120 mm
NK-32 125 mm
NK-34 130 mm
NK-36 120 mm
NK-38 125 mm
NK-40 130 mm

NK-30/NK-40

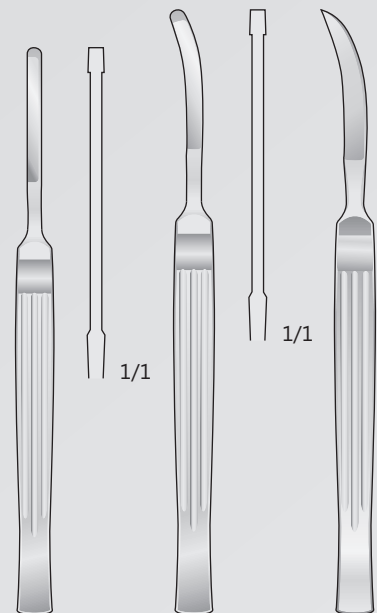

JOSEPH
NK-100 150 mm
CONVERSE
NK-101 160 mm
NK-102 160 mm

Scalpellklingen, steril
Scalpel blades, steril
Lame da bisturi sterili
Hojas de bisturias esteriles
Lames de bistouris steriles

Packungen à 100
Packages of 100 ea
Scatole da 100 pezzi
Cajas de 100 c/u
Boîtes de 100 pièces

Skalpellgriffe
Scalpel handles
Manici per bisturi
Mangos de bisturias
Manches de bistouris

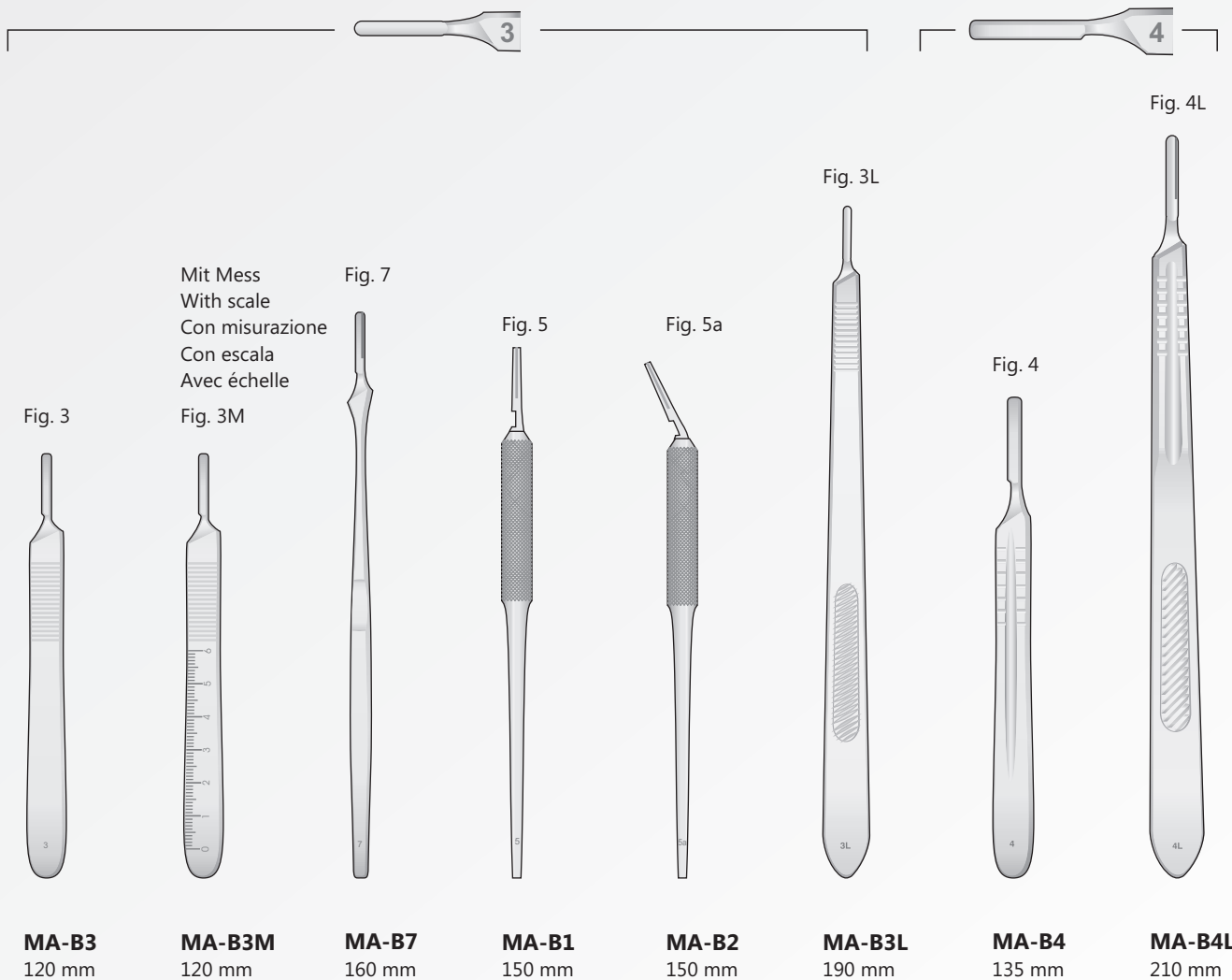
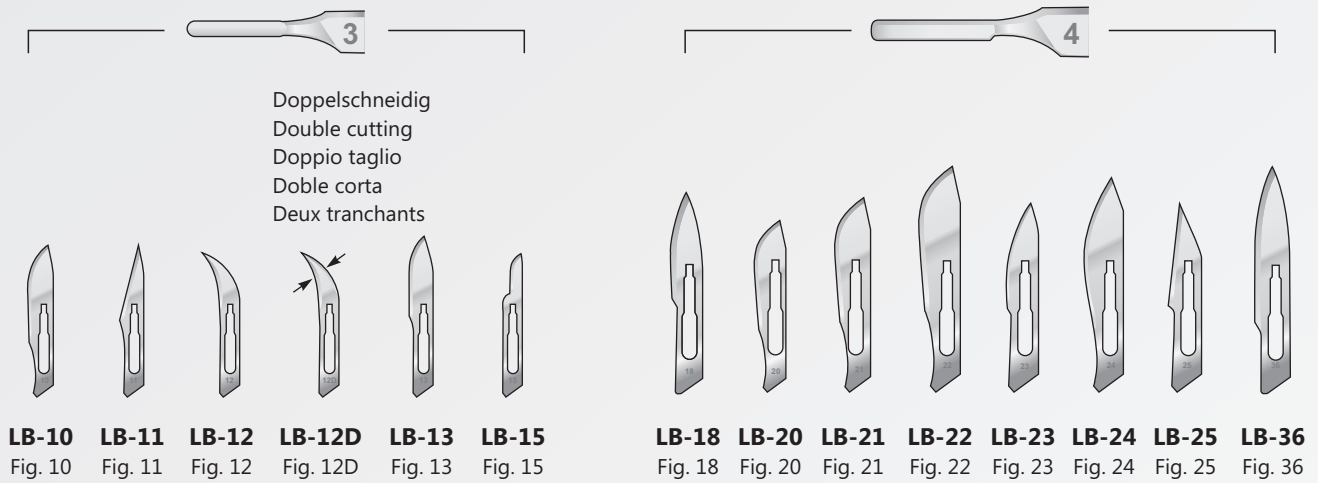

Skalpellgriffe, Klingen
Scalpel handles, Knives
Manici e bisturi
Mangos de bisturios, hojas
Manches de bistouris, lames

Für Mikro-Klingen
For Micro Blades
Per micro lame
Para micro Hojas
Pour Micro-Lame de bistouris



LB-361
Conf. 10 pz.



LB-362
Conf. 10 pz.



LB-363
Conf. 1 pz.



LB-364
Conf. 10 pz.



LB-365
Conf. 10 pz.



LB-366
Conf. 1 pz.



LB-367
Conf. 10 pz.



LB-368
Conf. 10 pz.



LB-369
Conf. 1 pz.



NK-1
100 mm



NK-3
130 mm



NK-2
150 mm



BB-46
135 mm



BB-48
155 mm

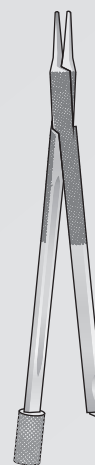

NK-12
120 mm

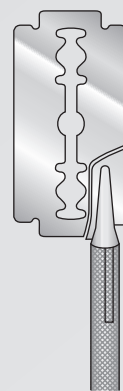

Spiegeldurchmesser - Diameter of mirrors - Diametro dello specchio
Diámetro de los espejos - Diamètre des miroirs

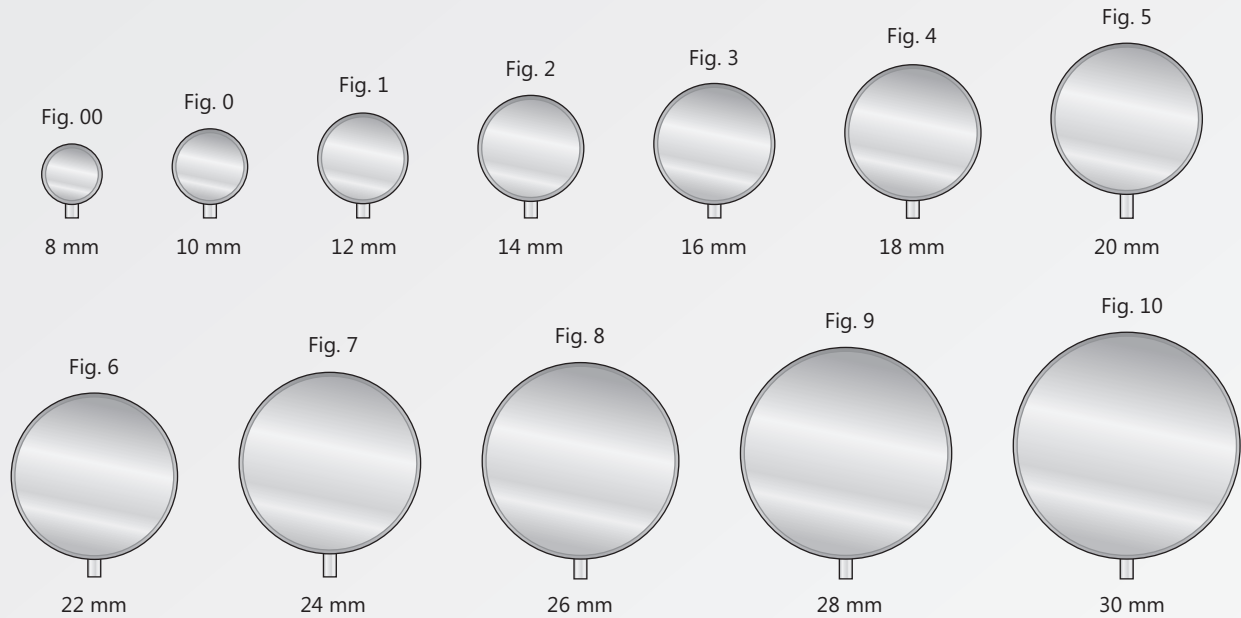

Inox
Kehlkopfspiegel mit
Sechskantgriff
Laryngeal mirrors
with hexagonal handle
Specchietto laringeo
con manico esagonale
Espejos laringeos
con manico exagonal
Miroirs laryngiens
avec manche hexagonal

| | Fig. |
|-------------|------|
| G- 8 | 00 |
| G-10 | 0 |
| G-12 | 1 |
| G-14 | 2 |
| G-16 | 3 |
| G-18 | 4 |
| G-20 | 5 |
| G-22 | 6 |
| G-24 | 7 |
| G-26 | 8 |
| G-28 | 9 |
| G-30 | 10 |

G-8/G-30
180 mm

Spiegelgriff
Mirrors handle
Manico per specchietti
Manico para espejos
Manche à miroir

Nikel-Chrom



MA-6
120 mm

Kehlkopfspiegel
Laryngeal mirrors
Specchietto laringeo
Espejos laringeos
Miroirs laryngiens

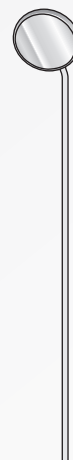

| | Fig. |
|--------------|------|
| P-00 | 00 |
| P- 0 | 0 |
| P-01 | 1 |
| P-02 | 2 |
| P-03 | 3 |
| P-04 | 4 |
| P-05 | 5 |
| P-06 | 6 |
| P-06A | 7 |
| P-06B | 8 |
| P-06C | 9 |
| P-06D | 10 |

P-00/P-06D
120 mm

Zungenspatel
Tongue depressor
Abbassalingua
Bejalenguas
Abaisse-langues

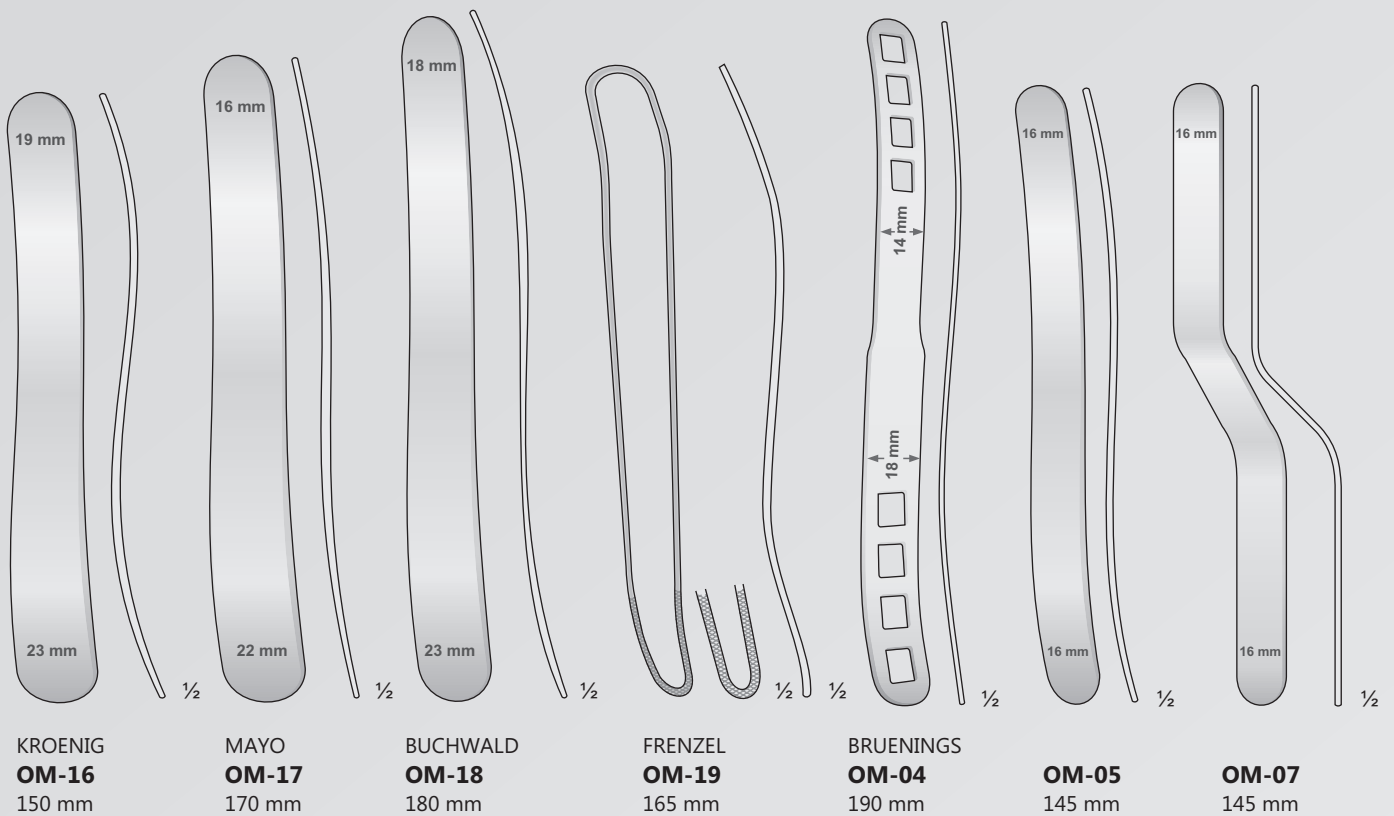

Bauch- und Darmspatel
Abdominal and Intestinal Spatulas
Spatole addominali e intestinali
Espátulas abdominales e intestinales
Spatules abdominaux et intestinaux

Biegsam - Malleable - Malleabile - Maleable - Malléable

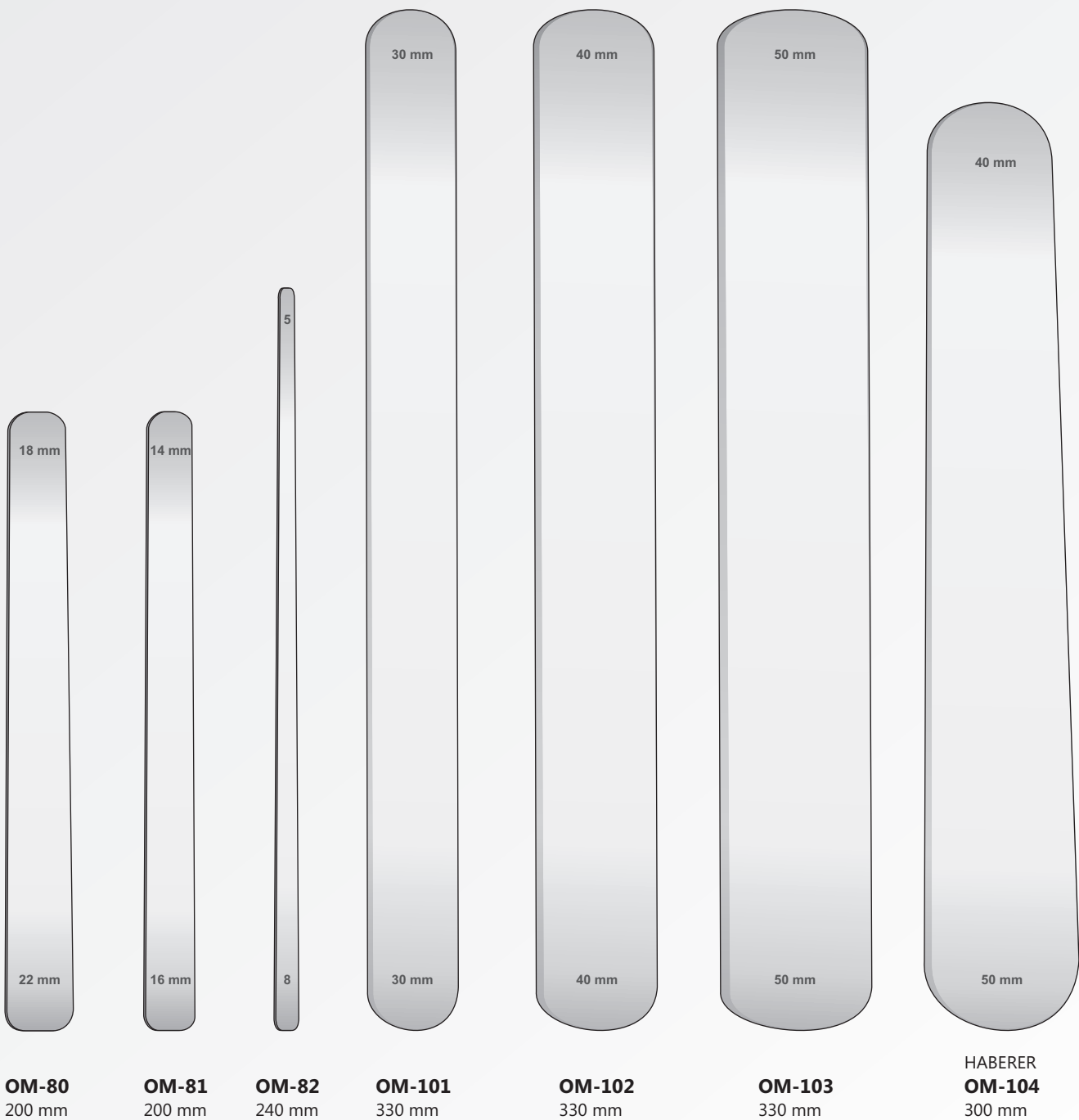



BONTEMPI
CHIRURGISCHE INSTRUMENTE

Scheren
Scissors
Forbici
Tijeras
Ciseaux

Chirurgische scheren
Operating scissors
Forbici chirurgiche
Tijeras para cirugía general
Ciseaux chirurgicaux

SUPER CUT

Mit einer Schneide gezahnt
With one blade serrated
Con una lama dentellata
Con una hoja dentada
Avec une lame dentèle



Chirurgische scheren
Operating scissors
Forbici chirurgiche
Tijeras para cirugía general
Ciseaux chirurgicaux

"Super-cut" scheren micro-schliff für tissue atrauma
"Super-cut" scissors for gripping tissue and cutting interproximally
Forbici "Super-cut" estremamente taglienti per tessuti con riduzione del trauma
Tijeras "super cortes" para cortar tissue-atrauma
Ciseaux "super cut" coupe les tissus en reduisant les risques de traumatisme

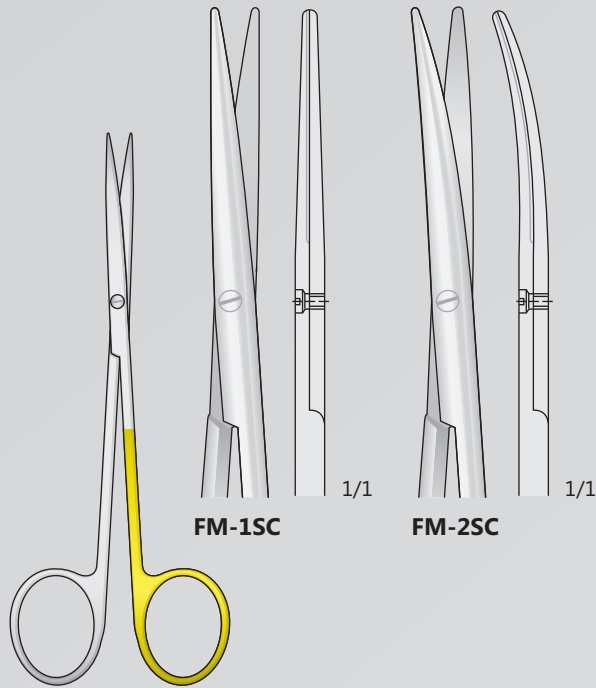

FM-1SC

FM-2SC

SUPER CUT
METZENBAUM
FM-1SC/FM-2SC
145 mm

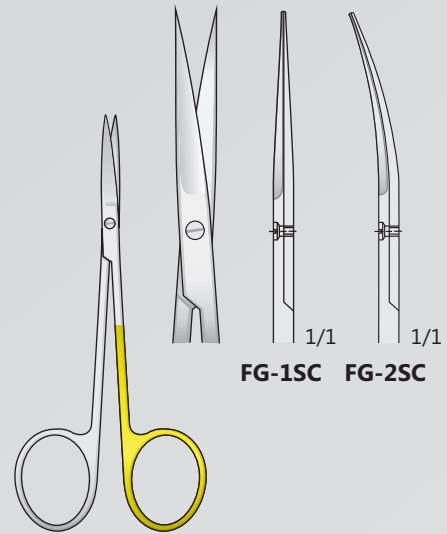

FG-1SC **FG-2SC**

SUPER CUT
IRIS
FG-1SC/FG-2SC
110 mm

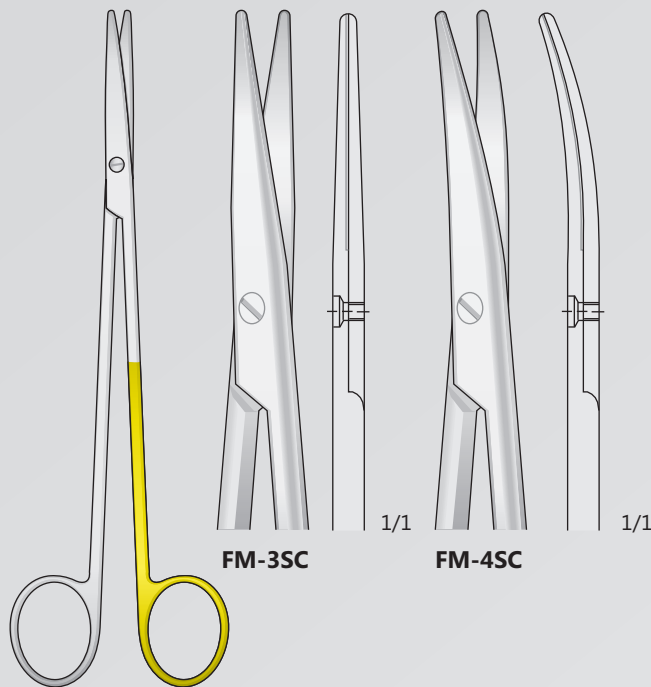

FM-3SC

FM-4SC

SUPER CUT
METZENBAUM
FM-3SC/FM-4SC
185 mm

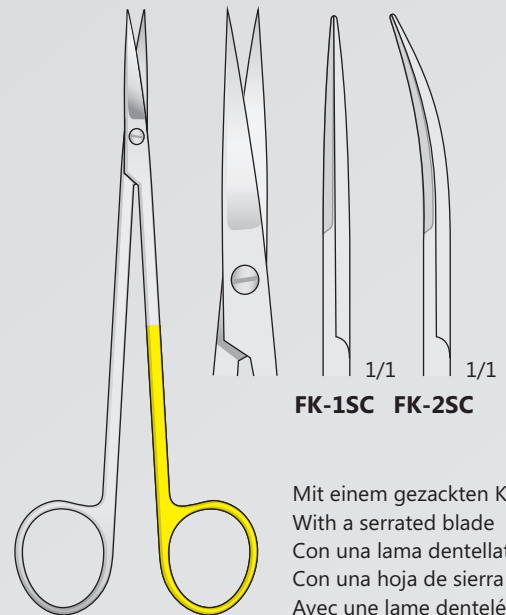

FK-1SC **FK-2SC**

SUPER CUT
KELLY
FK-1SC/FK-2SC
160 mm

Mit einem gezackten Klinge
With a serrated blade
Con una lama dentellata
Con una hoja de sierra
Avec une lame dentelée

“Super-cut” scheren micro-schliff für tissue atrauma
 “Super-cut” scissors for gripping tissue and cutting interproximally
 Forbici “Super-cut” estremamente taglienti per tessuti con riduzione del trauma
 Tijeras “super cortes” para cortar tissue-atrauma
 Ciseaux “super cut” coupe les tissus en reduisant les risques de traumatisme

Chirurgische scheren
 Operating scissors
 Forbici chirurgiche
 Tijeras para cirugía general
 Ciseaux chirurgicaux



SUPER CUT MAYO
FM-5SC/FM-6SC
 140 mm



SUPER CUT MAYO
FM-24SC/FM25SC
 170 mm

SUPER CUT MAYO
FM-29SC/FM30SC
 145 mm

Chirurgische scheren
Operating scissors
Forbici chirurgiche
Tijeras para cirugía general
Ciseaux chirurgicaux

"Super-cut" scheren micro-schliff für tissue atrauma, mit einer Schneide gezahnt
"Super-cut" scissors for gripping tissue and cutting interproximally, with one blade serrated
Forbici "Super-cut" estremamente taglienti per tessuti con riduzione del trauma, con una lama dentellata
Tijeras "super cortes" para cortar tissue-atrauma, con una hoja dentada
Ciseaux "super cut" coupe les tissus en reduisant les risques de traumatisme, avec une lame dentèle

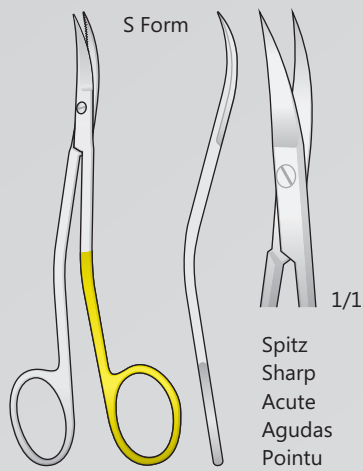

SUPER CUT
LA GRANGE
LG-1SC
115 mm

Spitz
Sharp
Acute
Agudas
Pointu

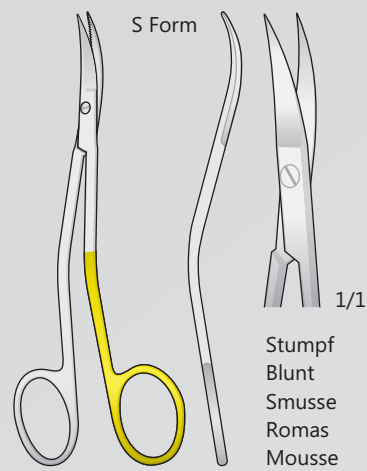

SUPER CUT
LA GRANGE
LG-2SC
115 mm

Stumpf
Blunt
Smusse
Romas
Mousse

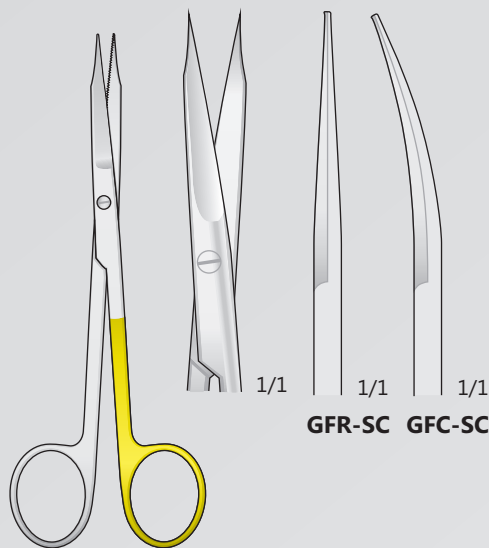

SUPER CUT
GOLDMAN-FOX
GFC-SC/GFR-SC
135 mm

GFR-SC GFC-SC

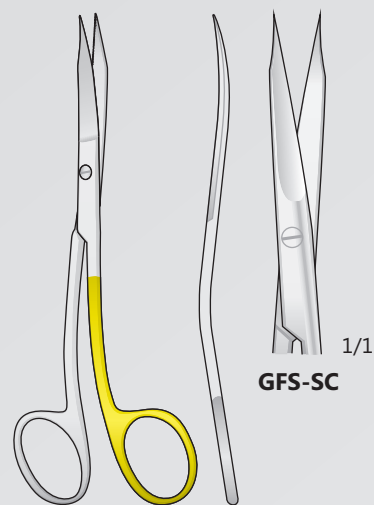

SUPER CUT
GOLDMAN-FOX
GFS-SC
130 mm

GFS-SC

"Super-cut" scheren micro-schliff für tissue atrauma, mit einer Schneide gezahnt
 "Super-cut" scissors for gripping tissue and cutting interproximally, with one blade serrated
 Forbici "Super-cut" estremamente taglienti per tessuti con riduzione del trauma, con una lama dentellata
 Tijeras "super cortes" para cortar tissue-atrauma, con una hoja dentada
 Ciseaux "super cut" coupe les tissus en reduisant les risques de traumatisme, avec une lame dentèle

Chirurgische scheren
 Operating scissors
 Forbici chirurgiche
 Tijeras para cirugía general
 Ciseaux chirurgicaux

SUPER CUT

Mit einer Schneide gezahnt
 With one blade serrated
 Con una lama dentellata
 Con una hoja dentada
 Avec une lame dentèle

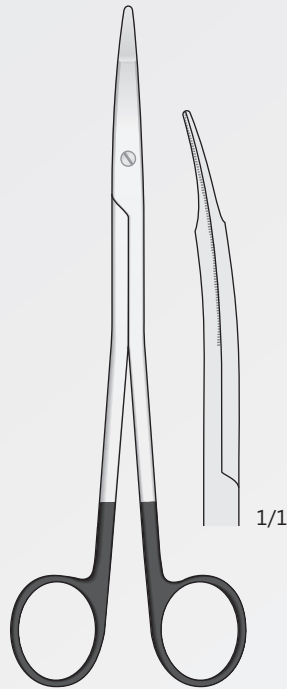

SUPER CUT
FREEMAN
FM-328
 180 mm

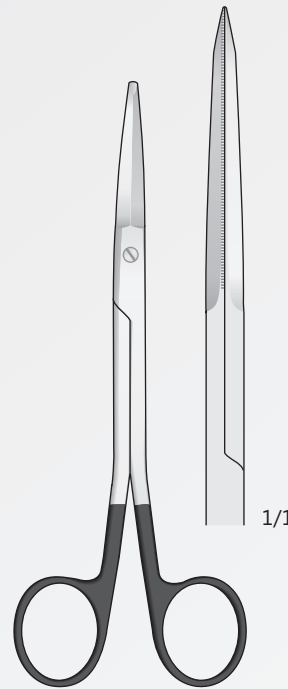

SUPER CUT
FACE-LIFT
FM-308
 160 mm

TUNGSTEN CARBIDE

Hartmetallschneiden
 Tungsten-carbide edges
 Lame al carburo di tungsteno
 Filos de carburo tungsteno
 Lames en carbure de tungstène

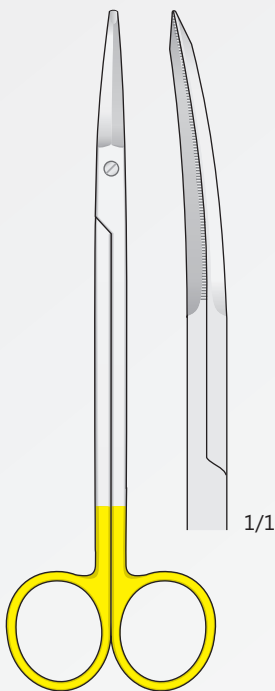

TUNGSTEN CARBIDE
FACE-LIFT
FM-343
 180 mm

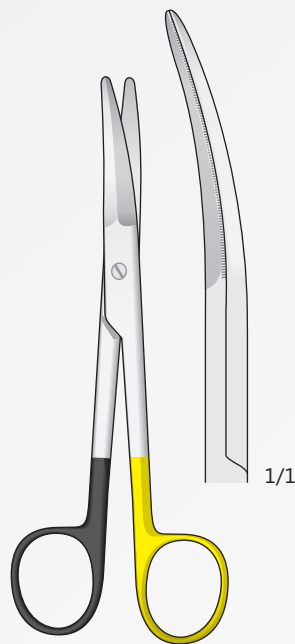

TUNGSTEN CARBIDE **SUPER CUT**
KAYE FACE-LIFT
FM-306
 150 mm

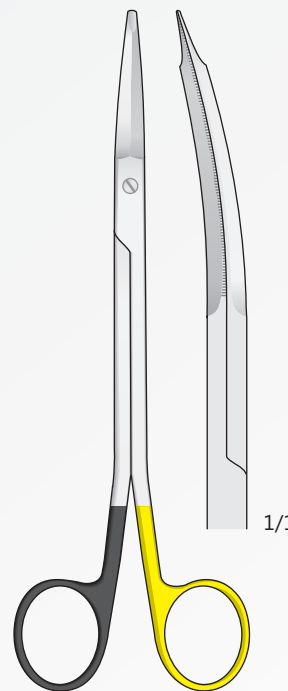

TUNGSTEN CARBIDE **SUPER CUT**
FREEMAN KAYE
FM-337
 180 mm

Chirurgische scheren
Operating scissors
Forbici chirurgiche
Tijeras para cirugía general
Ciseaux chirurgicaux

Hartmetallschneiden
Tungsten-carbide edges
Lame al carburo di tungsteno
Filos de carburo tungsteno
Lames en carbure de tungstène

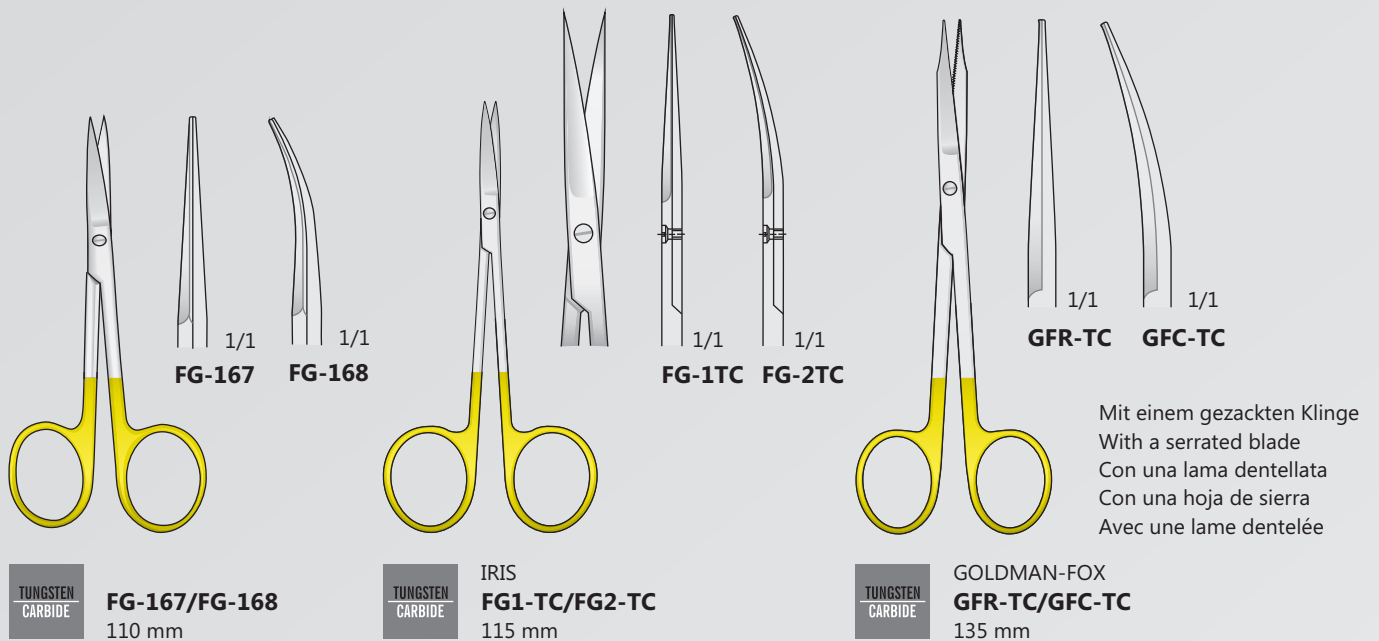
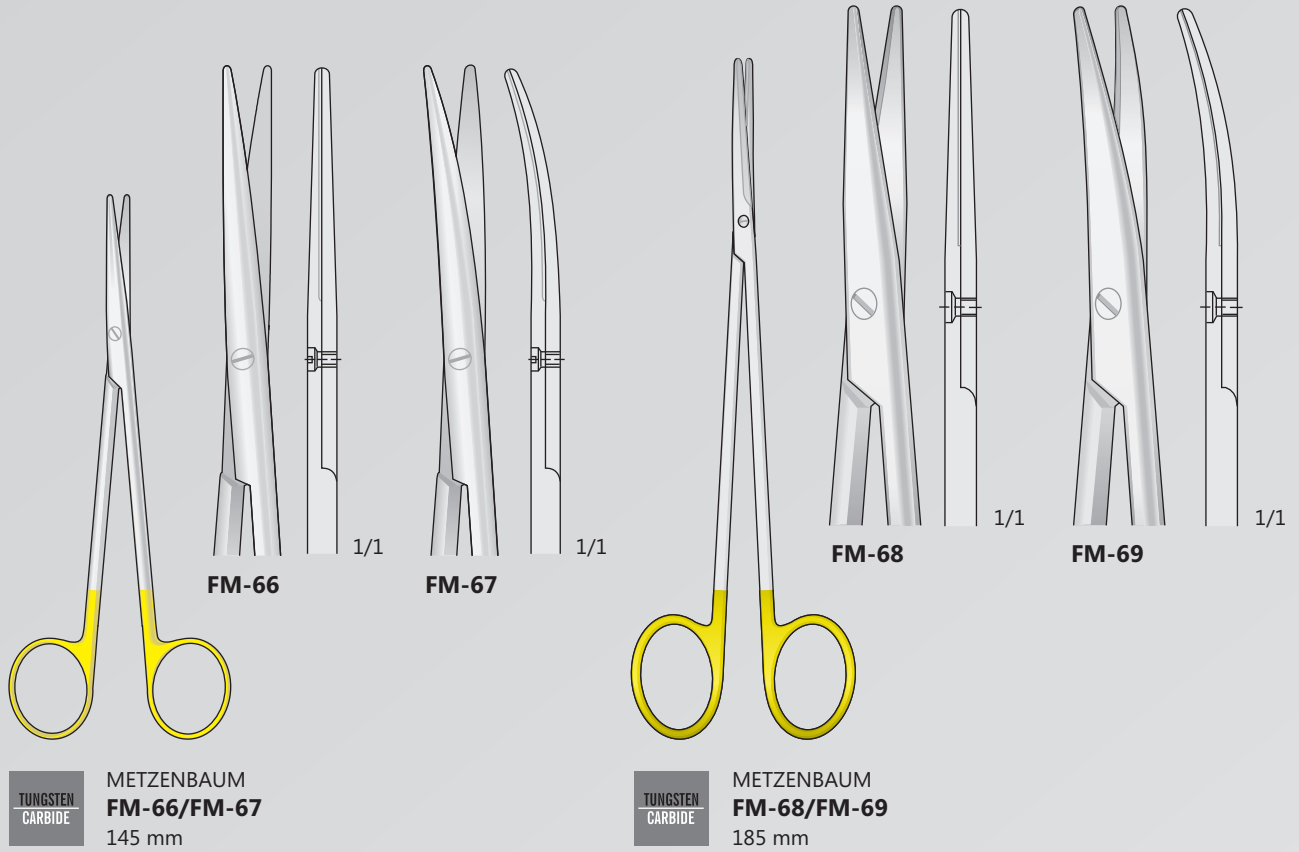

Hartmetallschneiden
Tungsten-carbide edges
Lame al carburo di tungsteno
Filos de carburo tungsteno
Lames en carbure de tungstène

Chirurgische scheren
Operating scissors
Forbici chirurgiche
Tijeras para cirugía general
Ciseaux chirurgicaux

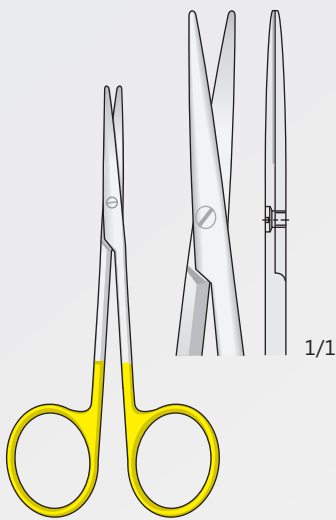

**TUNGSTEN
CARBIDE** **FM-118**
115 mm

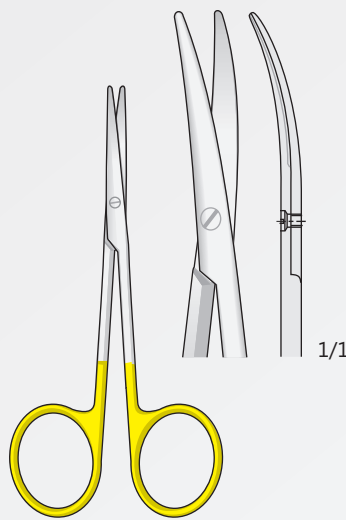

**TUNGSTEN
CARBIDE** **FM-119**
115 mm

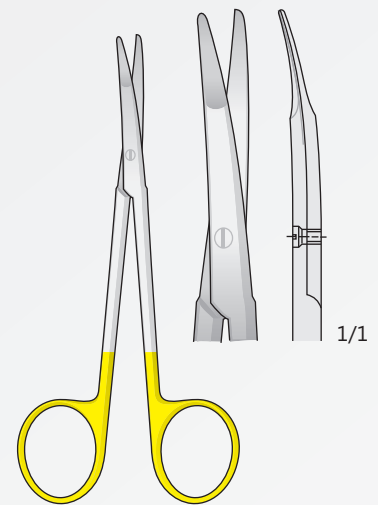

**TUNGSTEN
CARBIDE** **KILNER (RAGNELL)
FM-350**
125 mm

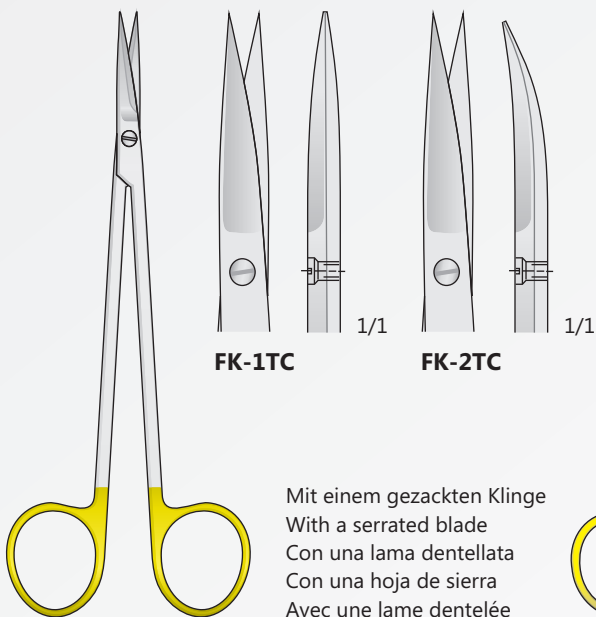

**TUNGSTEN
CARBIDE** **KELLY
FK-1TC/FK-2TC**
160 mm

Mit einem gezackten Klinge
With a serrated blade
Con una lama dentellata
Con una hoja de sierra
Avec une lame dentelée

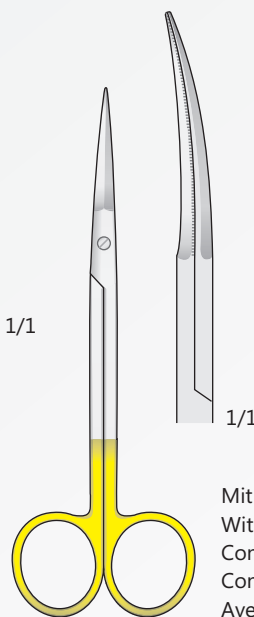

**TUNGSTEN
CARBIDE** **PECK-JOSEPH
FG-92**
140 mm

Mit einem gezackten Klinge
With a serrated blade
Con una lama dentellata
Con una hoja de sierra
Avec une lame dentelée

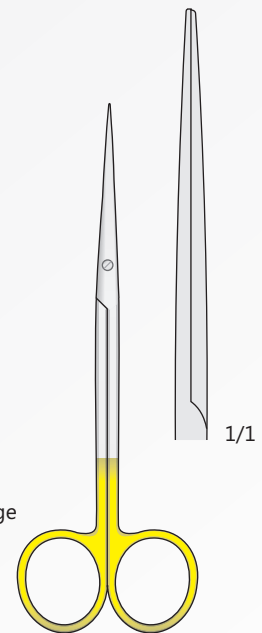

**TUNGSTEN
CARBIDE** **METZENBAUM-FINO
FM-96**
140 mm

Chirurgische scheren
Operating scissors
Forbici chirurgiche
Tijeras para cirugía general
Ciseaux chirurgicaux

Hartmetallschneiden
Tungsten-carbide edges
Lame al carburo di tungsteno
Filos de carburo tungsteno
Lames en carbure de tungstène

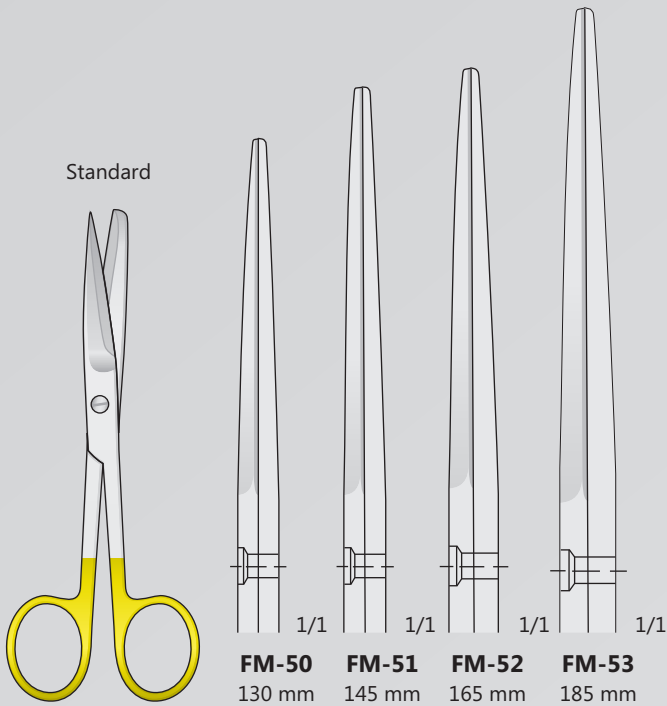

TUNGSTEN
CARBIDE

FM-50/FM-53

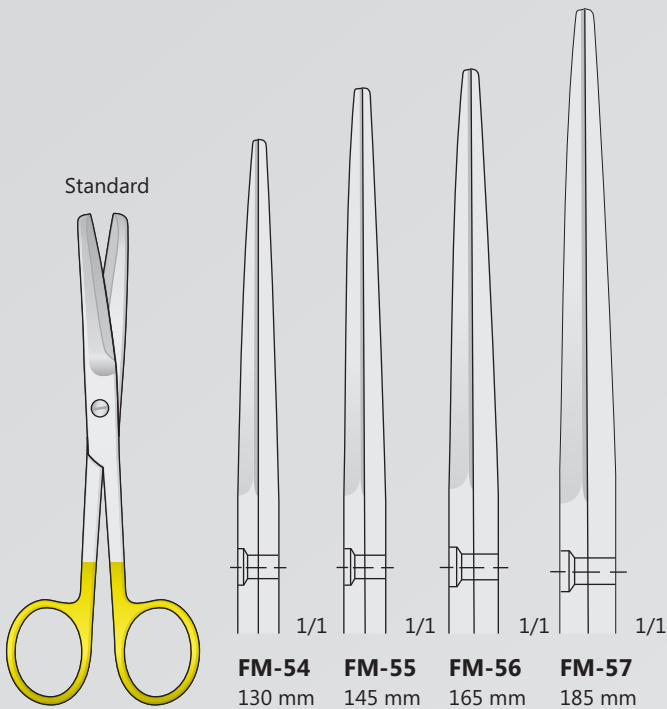

TUNGSTEN
CARBIDE

FM-54/FM-57

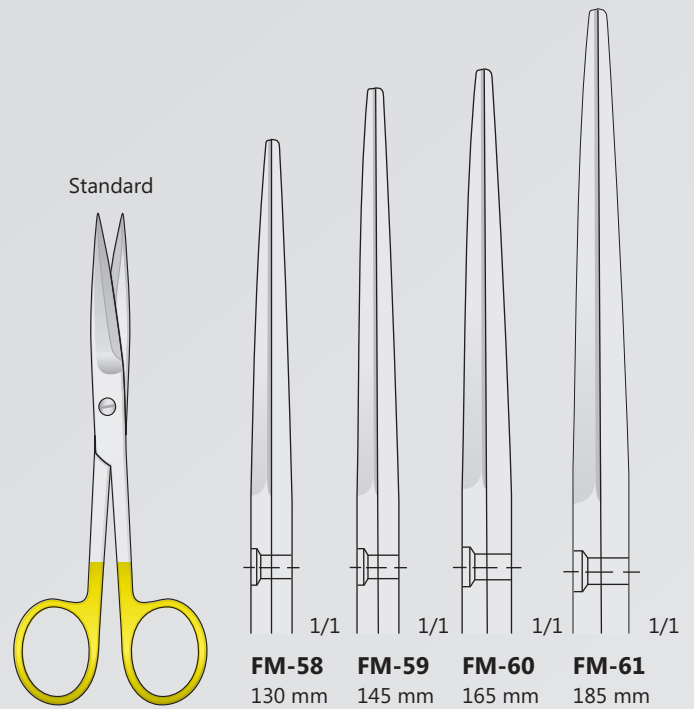

TUNGSTEN
CARBIDE

FM-58/FM-61

Hartmetallschneiden
Tungsten-carbide edges
Lame al carburo di tungsteno
Filos de carburo tungsteno
Lames en carbure de tungstène

Chirurgische scheren
Operating scissors
Forbici chirurgiche
Tijeras para cirugía general
Ciseaux chirurgicaux

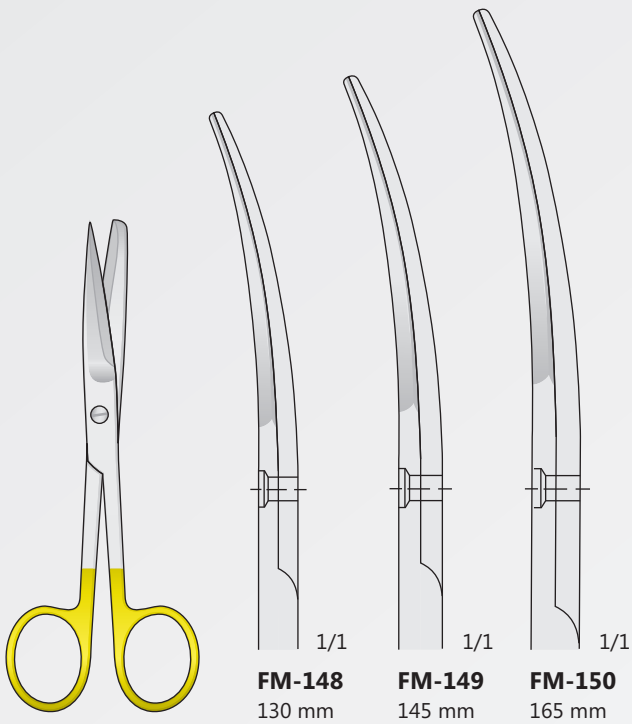

TUNGSTEN
CARBIDE

FM-148/FM-150



TUNGSTEN
CARBIDE

FM-151/FM-153

TUNGSTEN
CARBIDE

FM-145/FM-147

Chirurgische scheren
Operating scissors
Forbici chirurgiche
Tijeras para cirugía general
Ciseaux chirurgicaux

Hartmetallschneiden
Tungsten-carbide edges
Lame al carburo di tungsteno
Filos de carburo tungsteno
Lames en carbure de tungstène

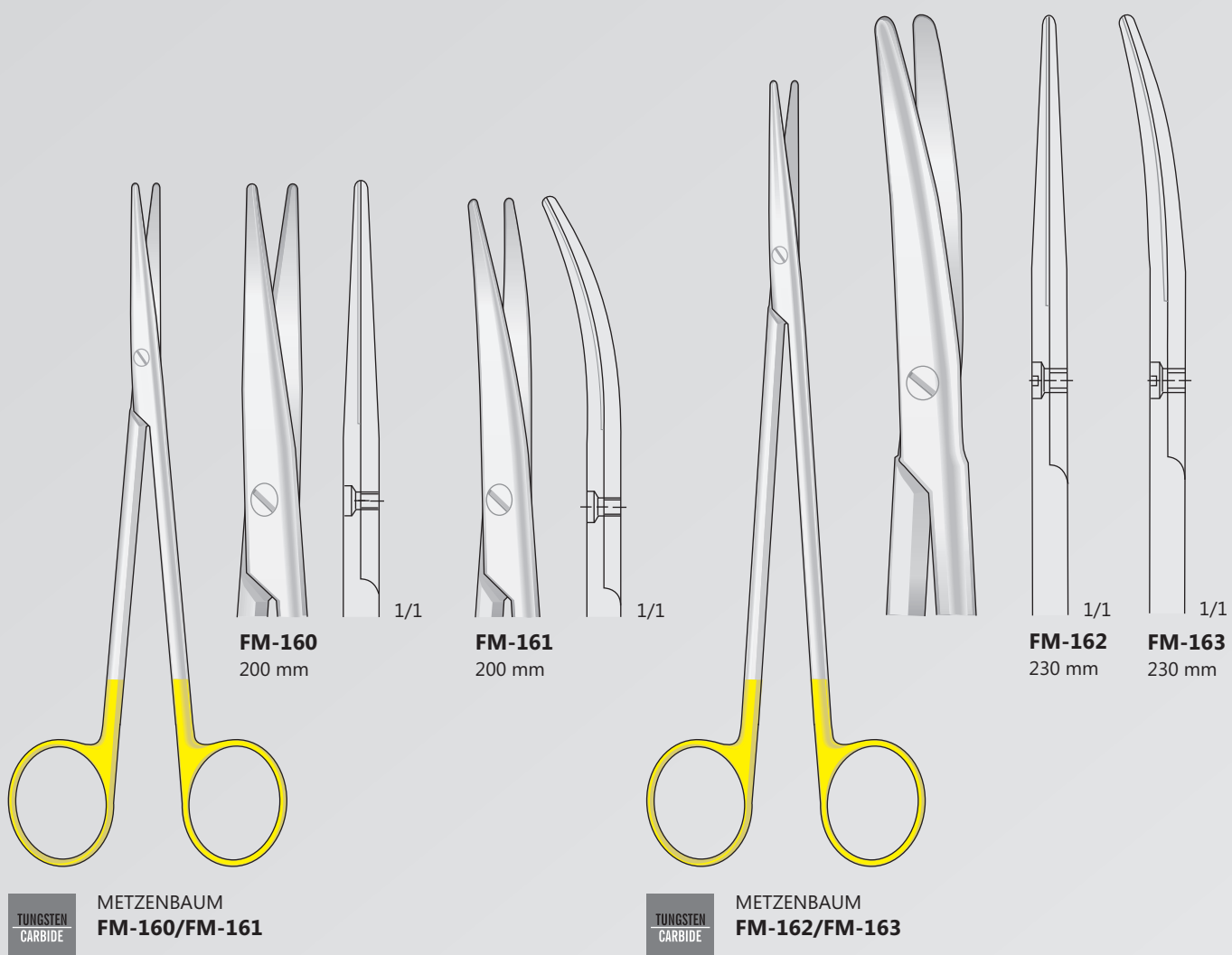

Hartmetallschneiden
Tungsten-carbide edges
Lame al carburo di tungsteno
Filos de carburo tungsteno
Lames en carbure de tungstène

Chirurgische scheren
Operating scissors
Forbici chirurgiche
Tijeras para cirugía general
Ciseaux chirurgicaux

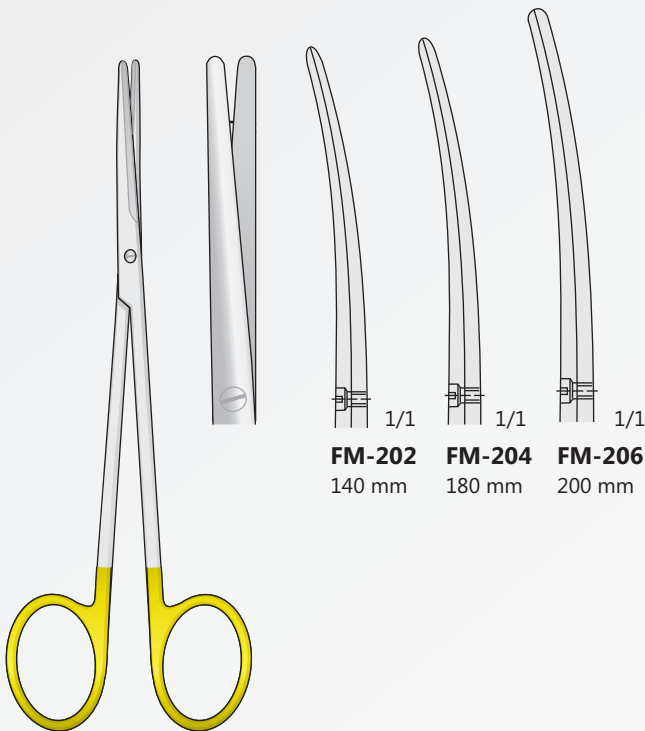
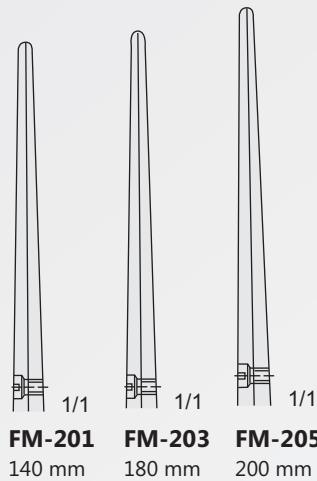

**TUNGSTEN
CARBIDE**
METZENBAUM-FINO
FM-201/FM-206

**TUNGSTEN
CARBIDE**
METZENBAUM-FINO
FM-207/FM-212

Chirurgische scheren
Operating scissors
Forbici chirurgiche
Tijeras para cirugía general
Ciseaux chirurgicaux

Hartmetallschneiden
Tungsten-carbide edges
Lame al carburo di tungsteno
Filos de carburo tungsteno
Lames en carbure de tungstène

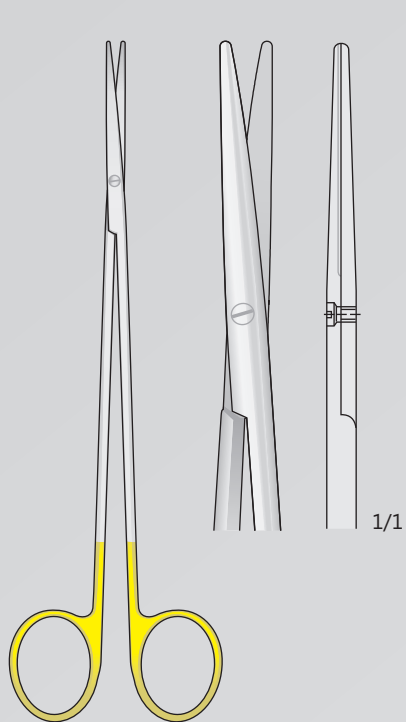

TUNGSTEN CARBIDE
TOENNIS-ADSON
FG-63
180 mm

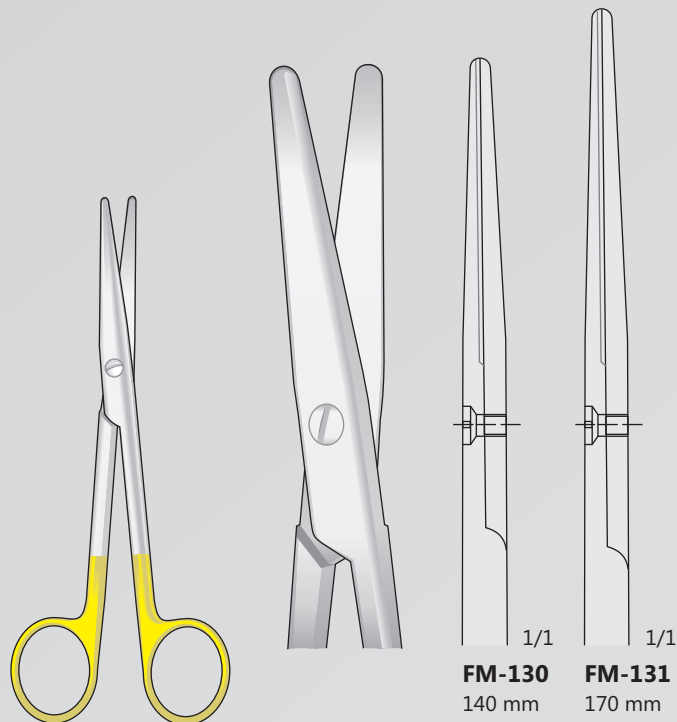

TUNGSTEN CARBIDE
MAYO-STILLE
FM-130/FM-131

FM-130 140 mm
FM-131 170 mm

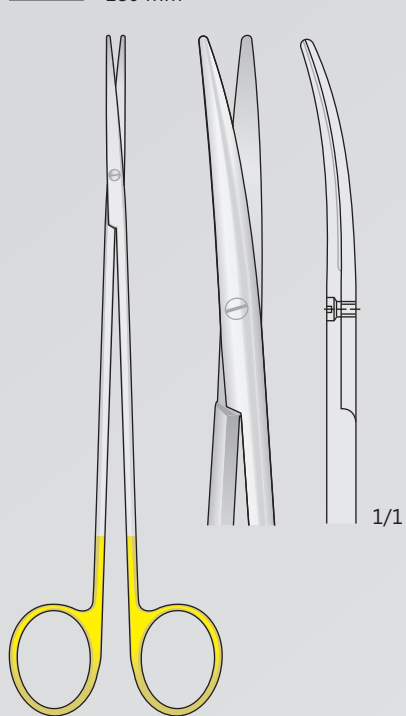

TUNGSTEN CARBIDE
TOENNIS-ADSON
FG-64
180 mm

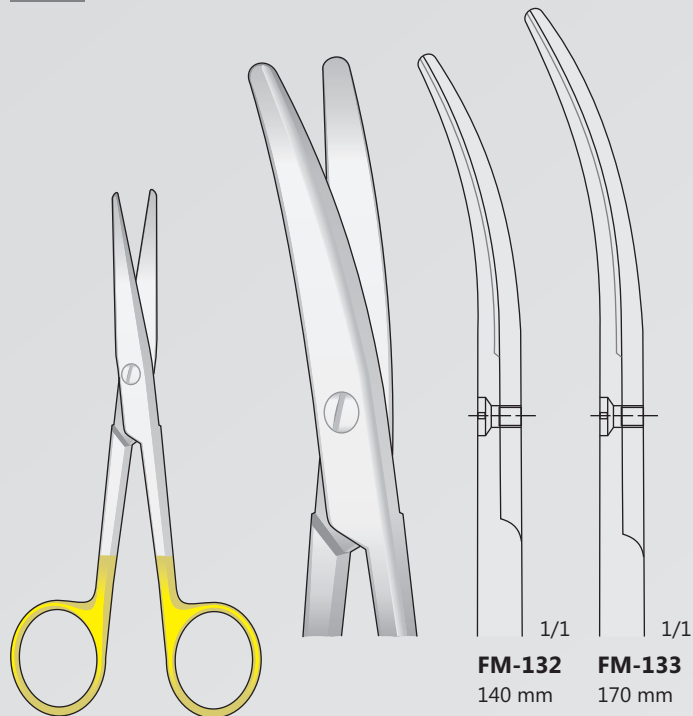

TUNGSTEN CARBIDE
MAYO-STILLE
FM-132/FM-133

FM-132 140 mm
FM-133 170 mm

Hartmetallschneiden
Tungsten-carbide edges
Lame al carburo di tungsteno
Filos de carburo tungsteno
Lames en carbure de tungstène

Chirurgische scheren
Operating scissors
Forbici chirurgiche
Tijeras para cirugía general
Ciseaux chirurgicaux



Chirurgische scheren
Operating scissors
Forbici chirurgiche
Tijeras para cirugía general
Ciseaux chirurgicaux

Hartmetallschneiden
Tungsten-carbide edges
Lame al carburo di tungsteno
Filos de carburo tungsteno
Lames en carbure de tungstène

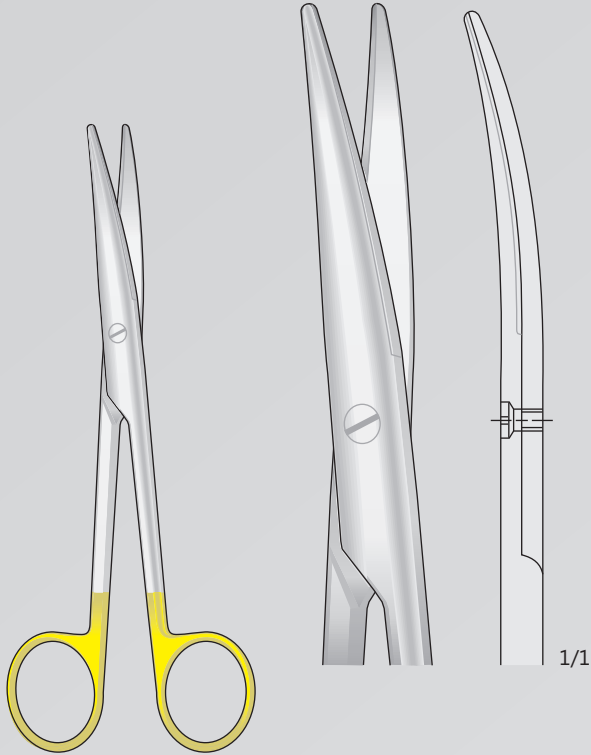

TUNGSTEN CARBIDE
MAYO-LEXER
FM-139
165 mm

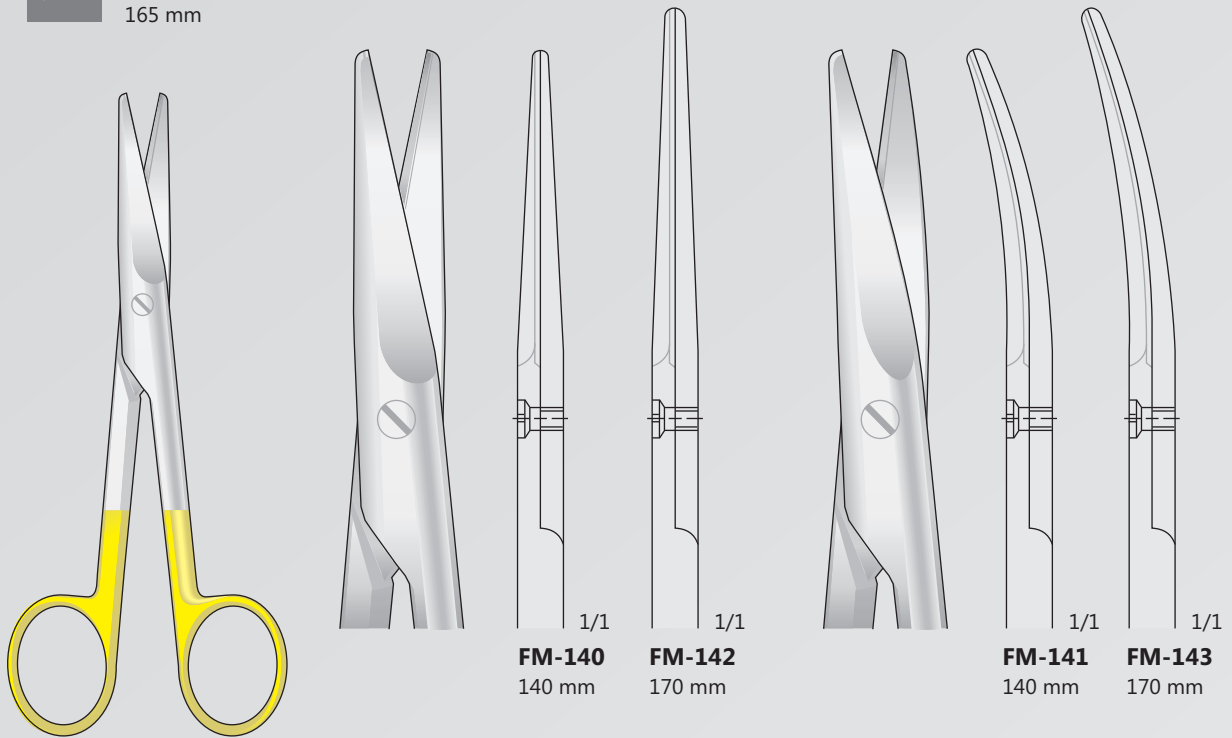

TUNGSTEN CARBIDE
MAYO
FM-140/FM-143

FM-140
140 mm

FM-142
170 mm

FM-141
140 mm

FM-143
170 mm

Hartmetallschneiden
Tungsten-carbide edges
Lame al carburo di tungsteno
Filos de carburo tungsteno
Lames en carbure de tungstène

Chirurgische scheren
Operating scissors
Forbici chirurgiche
Tijeras para cirugía general
Ciseaux chirurgicaux

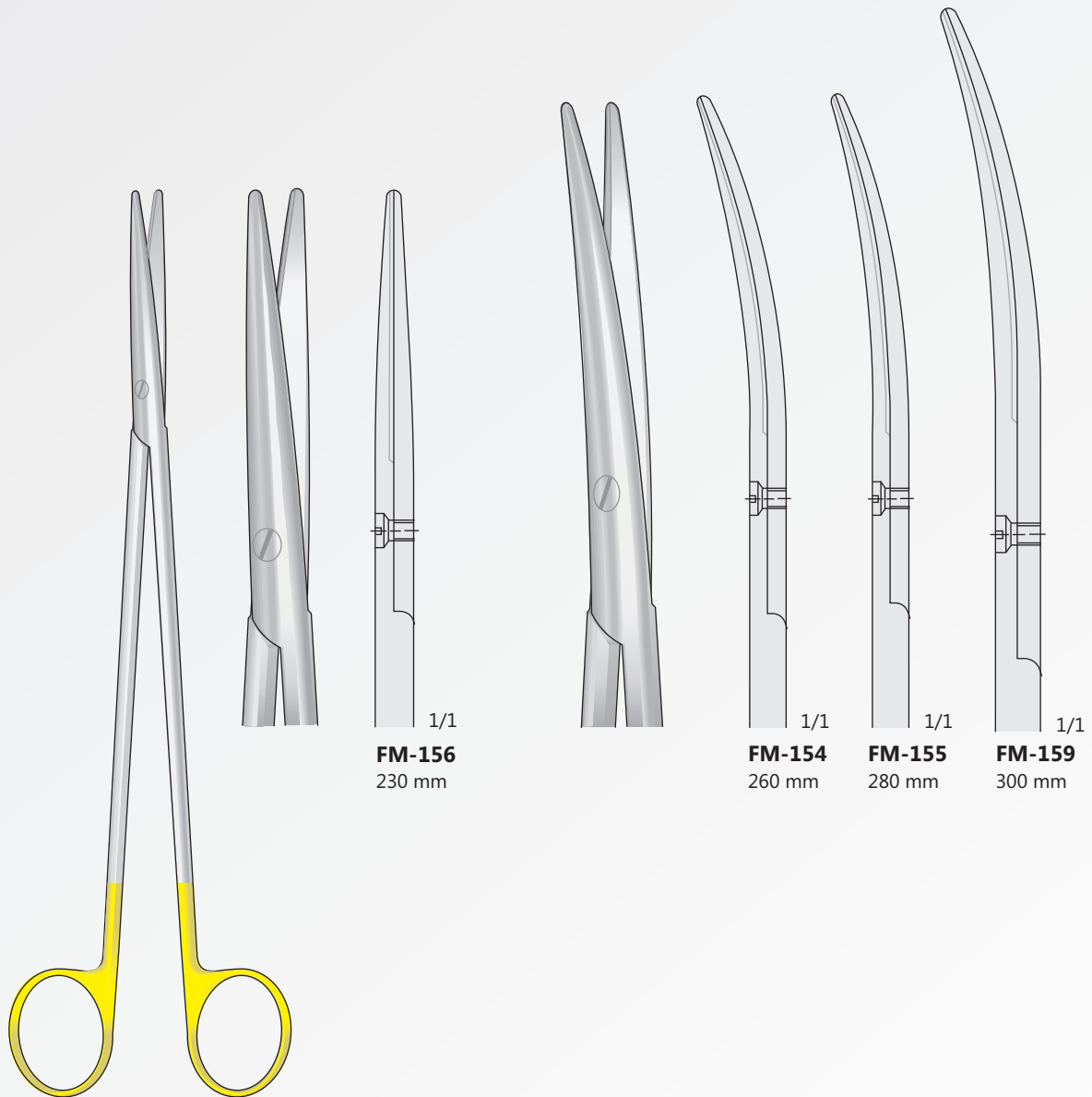

**TUNGSTEN
CARBIDE** NELSON-METZENBAUM
FM-154/FM-159

Chirurgische scheren
Operating scissors
Forbici chirurgiche
Tijeras para cirugía general
Ciseaux chirurgicaux

Hartmetallschneiden
Tungsten-carbide edges
Lame al carburo di tungsteno
Filos de carburo tungsteno
Lames en carbure de tungstène

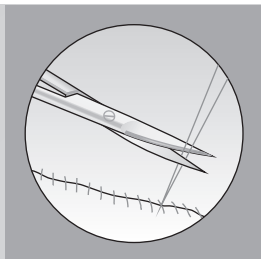

Wellenschliff

Scheren mit wellenschliff auf einer Schnittfläche
Scissors cut one serrated cutting edge
Forbici con taglio ondulato su una lama
Tijeras con ondas afilados
Ciseaux avec affutage spécial ont une lame dentée

Links Scheren
Left Scissors
Forbici per mancini
Tijeras para zurdos
Gauche Ciseaux

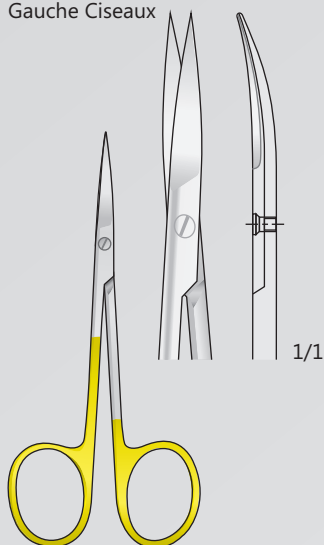

**TUNGSTEN
CARBIDE** IRIS
FM-100L
110 mm

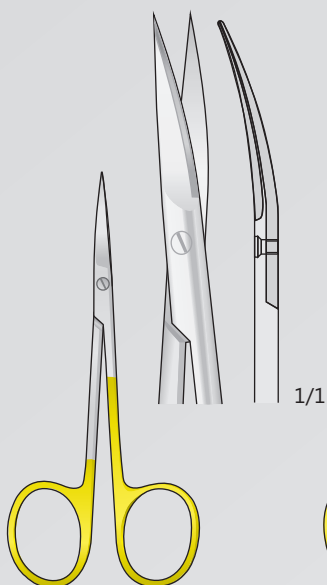

**TUNGSTEN
CARBIDE** IRIS
FM-100
110 mm

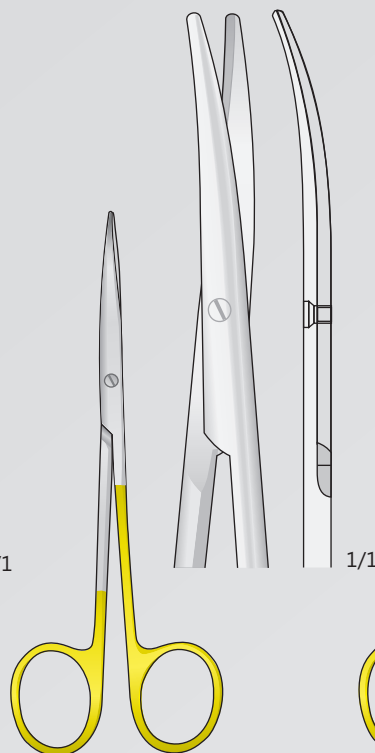

**TUNGSTEN
CARBIDE** METZENBAUM
FM-102
145 mm

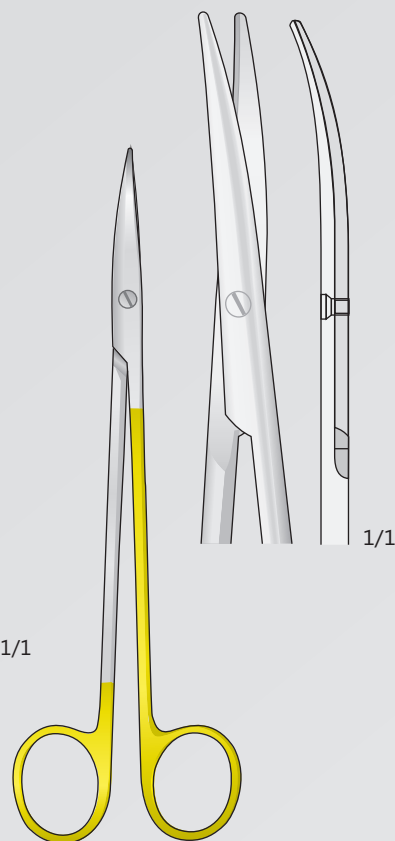

**TUNGSTEN
CARBIDE** METZENBAUM
FM-104
185 mm

Forbici per dissezione
Dissecting Scissors
Präparierscheren
Ciseaux à dissection
Tijeras para preparaciones

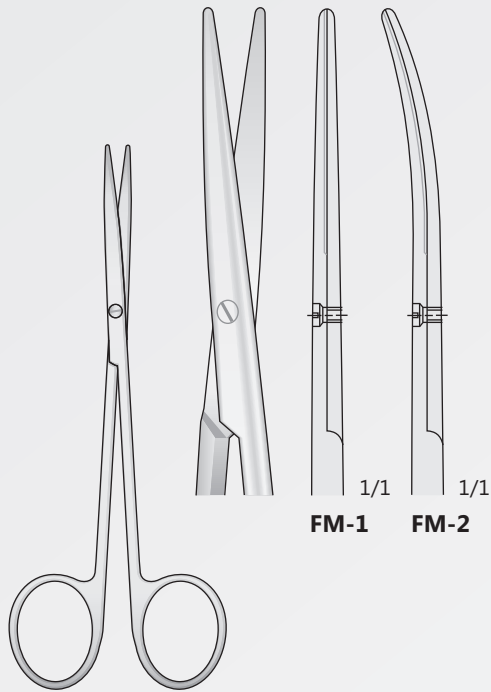

METZENBAUM
FM-1/FM-2
145 mm

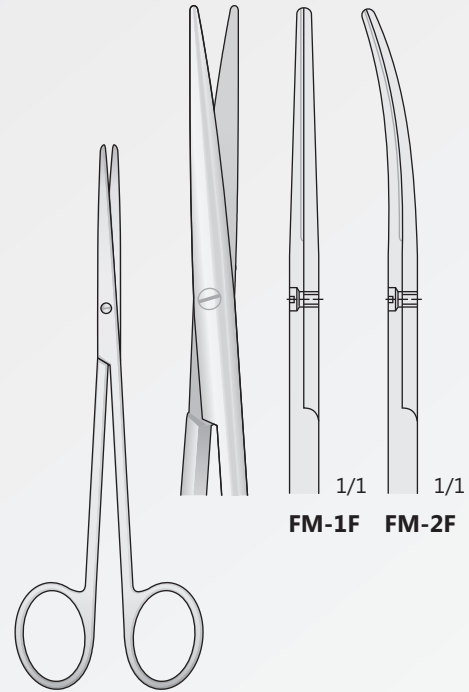

METZENBAUM-FINE
FM-1F/FM-2F
145 mm



METZENBAUM
FM-3/FM-4
185 mm

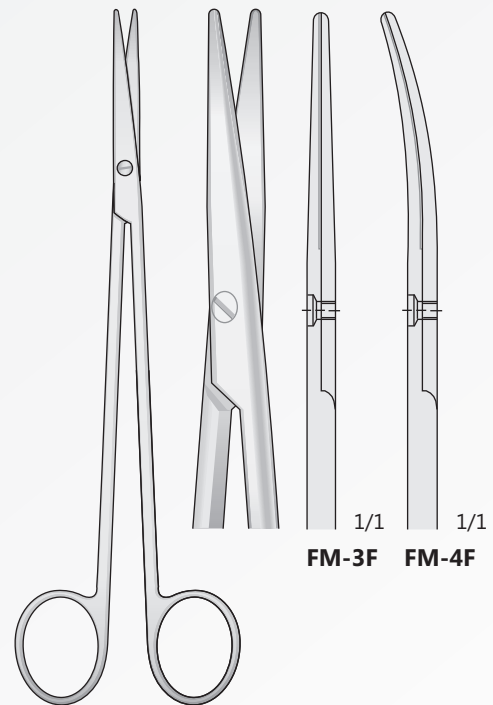

METZENBAUM-FINE
FM-3F/FM-4F
185 mm

Chirurgische scheren
Operating scissors
Forbici chirurgiche
Tijeras para cirugía general
Ciseaux chirurgicaux

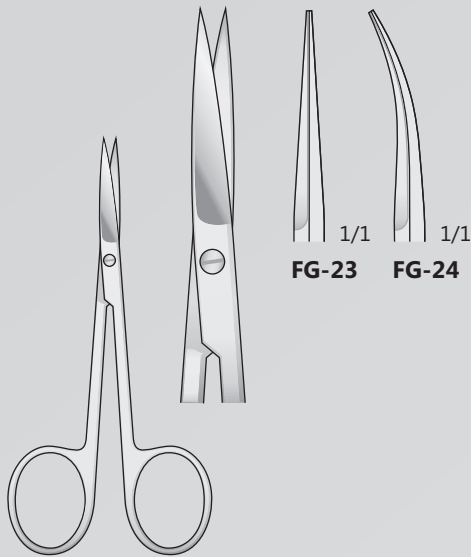

FG-23/FG-24
110 mm

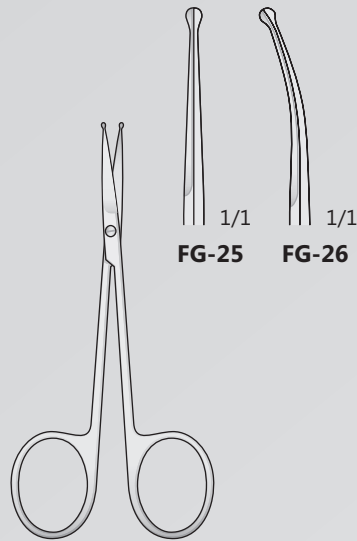

FG-25/FG-26
110 mm

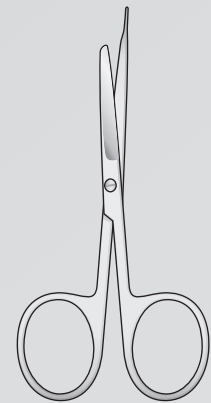

FG-27
100 mm

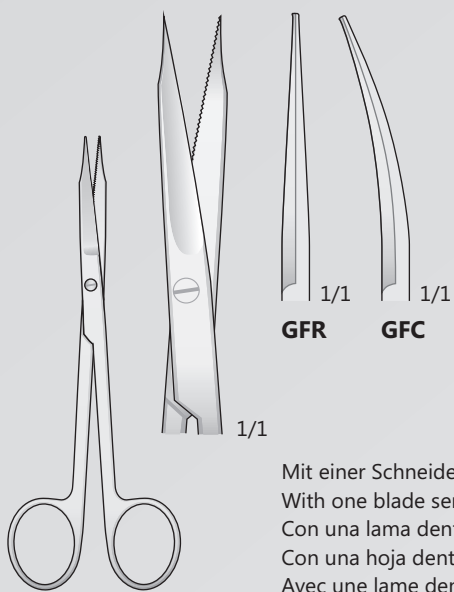

GOLDMAN-FOX
GFR/GFC
120 mm

Mit einer Schneide gezahnt
With one blade serrated
Con una lama dentellata
Con una hoja dentada
Avec une lame dentèle

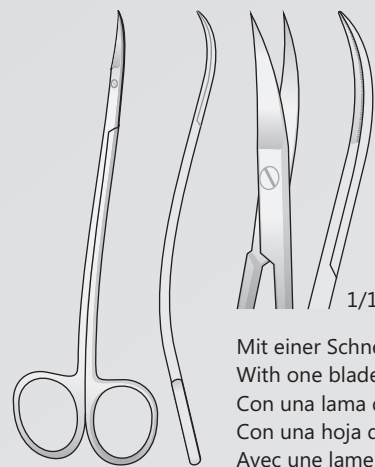

LA GRANGE
LG-1
115 mm

Mit einer Schneide gezahnt
With one blade serrated
Con una lama dentellata
Con una hoja dentada
Avec une lame dentèle

Präparierscheren
Dissecting Scissors
Forbici per dissezione
Tijeras para preparaciones
Ciseaux à dissection

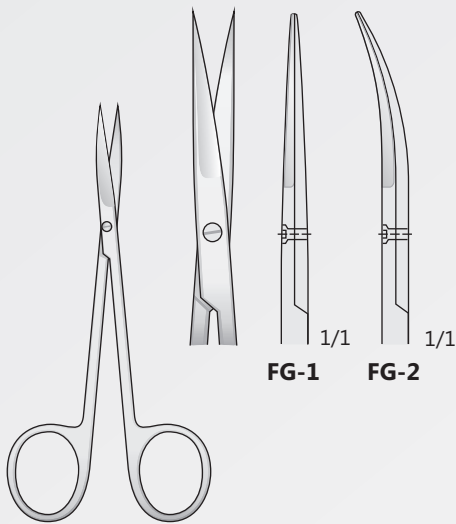

IRIS
FG-1/FG-2
110 mm

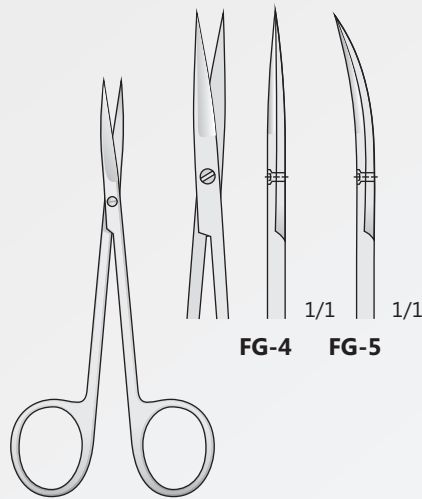

FG-4/FG-5
105 mm

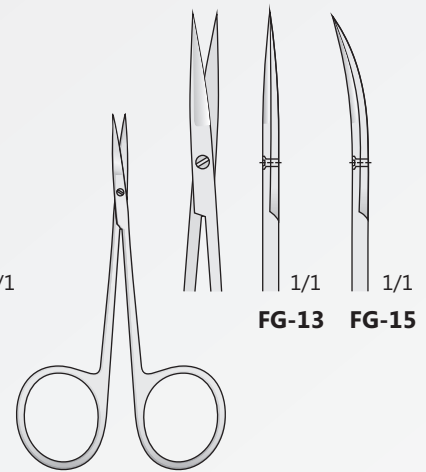

MICRO-IRIS
FG-13/FG-15
85 mm

Stumpf
Blunt
Smussa
Romo
Émoussé

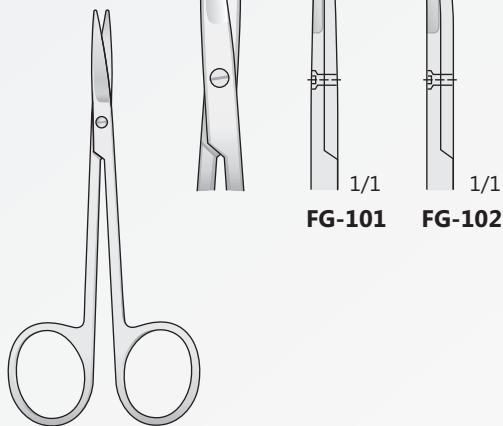

FG-101/FG-102
110 mm

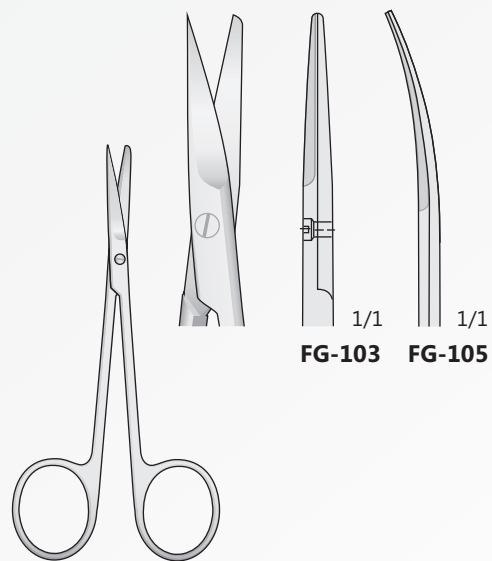

FG-103/FG-105
110 mm

Feine Scheren
Delicate scissors
Forbici delicate
Tijeras finas
Ciseaux délicate

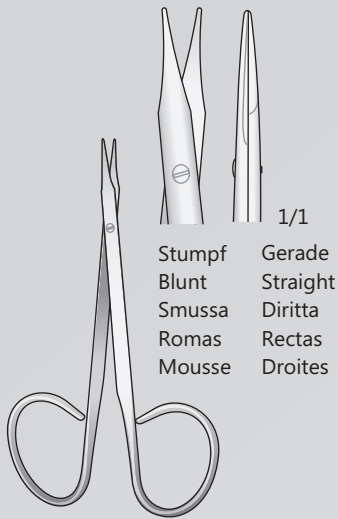

1/1
Stumpf Gerade
Blunt Straight
Smussa Diritta
Romas Rectas
Mousse Droites

STEVENS
FG-209
100 mm

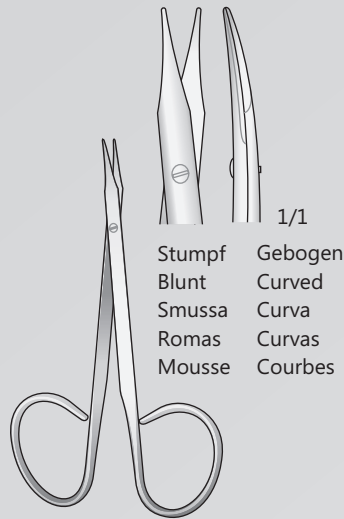

1/1
Stumpf Gebogen
Blunt Curved
Smussa Curva
Romas Curvas
Mousse Courbes

STEVENS
FG-210
100 mm

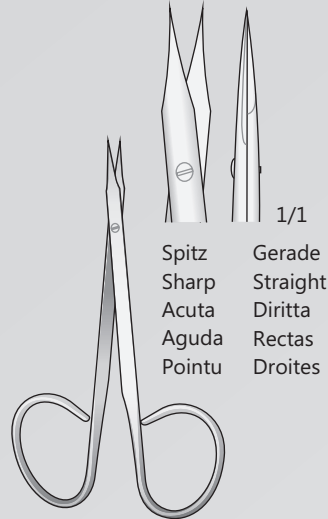

1/1
Spitz Gerade
Sharp Straight
Acuta Diritta
Aguda Rectas
Pointu Droites

WALTON
FG-211
100 mm

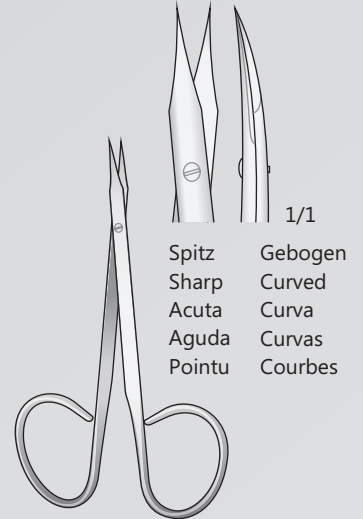

1/1
Spitz Gebogen
Sharp Curved
Acuta Curva
Aguda Curvas
Pointu Courbes

WALTON
FG-212
100 mm

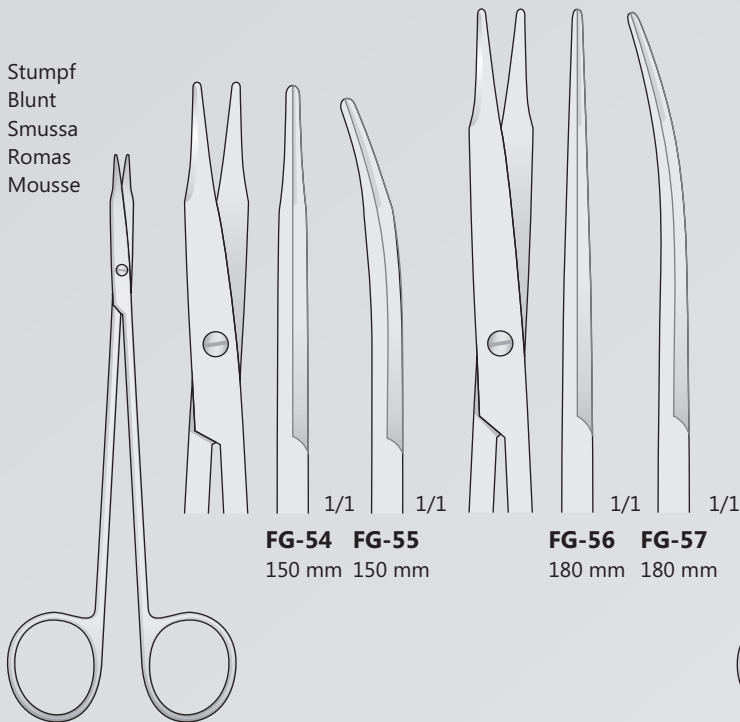

Stumpf
Blunt
Smussa
Romas
Mousse

FG-54 FG-55
150 mm 150 mm

FG-56 FG-57
180 mm 180 mm

REYNOLDS (JAMESON)
FG-54/FG-57

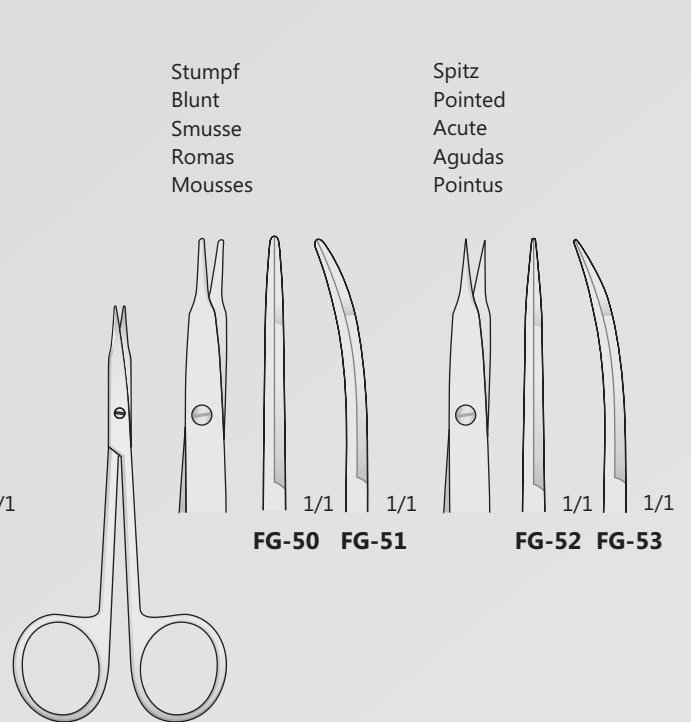

Stumpf
Blunt
Smusse
Romas
Mousses

Spitz
Pointed
Acute
Agudas
Pointus

FG-50 FG-51
1/1 1/1

FG-52 FG-53
1/1 1/1

STEVENS
FG-50/FG-53
110 mm

Feine Scheren
Delicate scissors
Forbici delicate
Tijeras finas
Ciseaux délicate

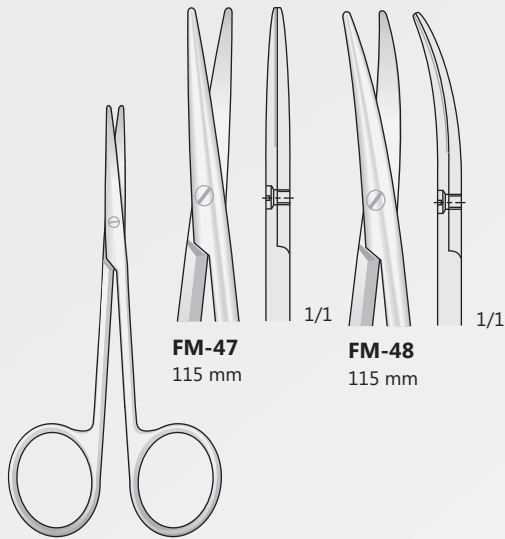

FM-47
115 mm

FM-48
115 mm

BABY - METZENBAUM
FM-47/FM-48
115 mm

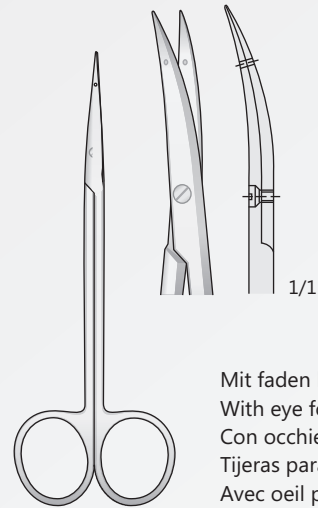

Mit faden bohrung
With eye for suture
Con occhiello per sutura
Tijeras para ligaduras
Avec oeil pour les sutures

LITTLER
FG-100
120 mm

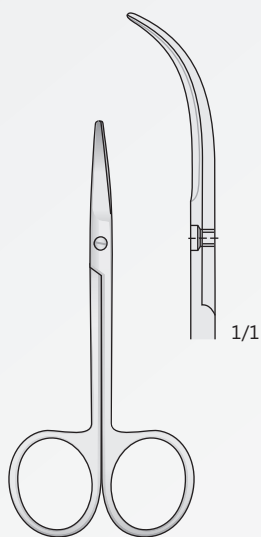

FOMON
FG-43
110 mm

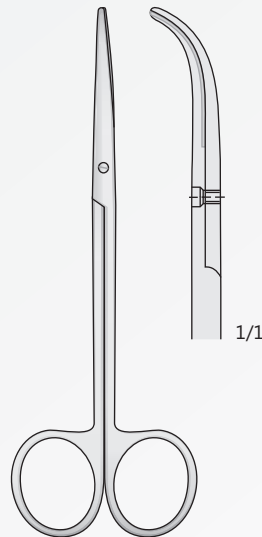

FG-44
140 mm



FM-12

FM-109

METZENBAUM
FM-12/FM-109
150 mm

Chirurgische scheren
Operating scissors
Forbici chirurgiche
Tijeras para cirugía general
Ciseaux chirurgicaux

Inzisionscheren
Incision scissors
Forbici da incisione
Tijeras para incisión
Ciseaux à incision

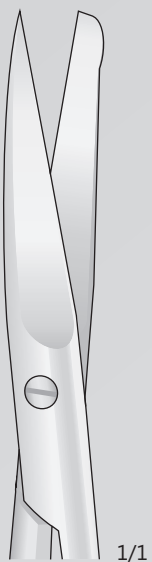
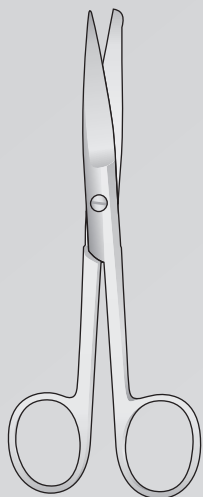

1/1



1/1

FG-16
130 mm



1/1

FG-17
145 mm



1/1

FG-18
185 mm

FG-16/FG-18

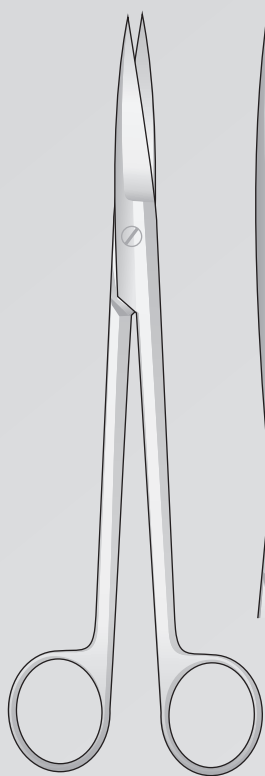

SIMS
FG-138
200 mm



1/1

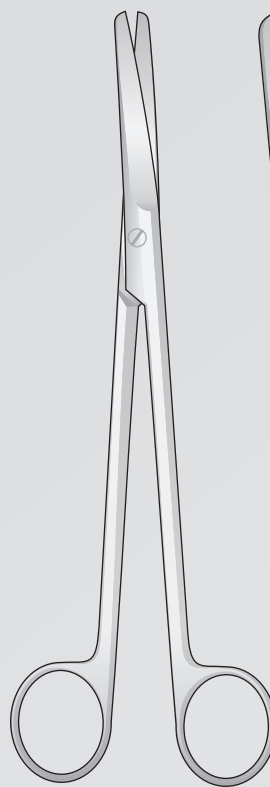

SIMS
FG-139
210 mm



1/1



Standard

Spitz
Sharp
Acuta
Agudo
Aigu



FM-7/FM-45

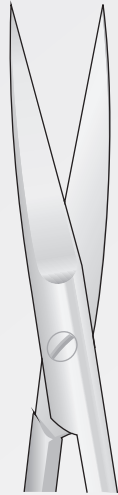

1/1



1/1

FM-41
130 mm

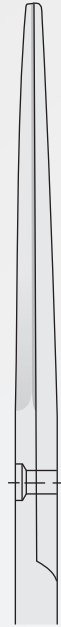

1/1

FM-7
145 mm



1/1

FM-43
165 mm

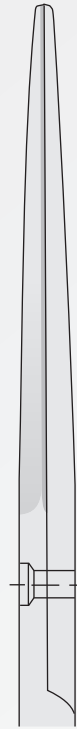

1/1

FM-45
185 mm

Spitz
Sharp
Acuta
Agudo
Aigu

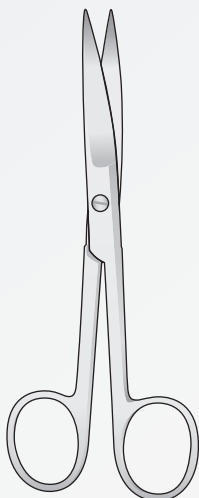

FM-8/FM-46



1/1



1/1

FM-42
130 mm



1/1

FM-8
145 mm

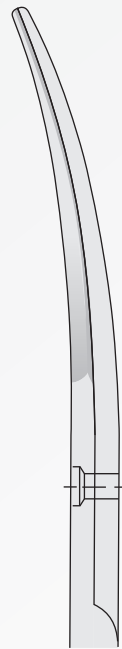

1/1

FM-44
165 mm

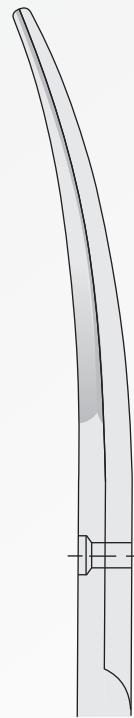

1/1

FM-46
185 mm

Chirurgische scheren
Operating scissors
Forbici chirurgiche
Tijeras para cirugía general
Ciseaux chirurgicaux

Standard

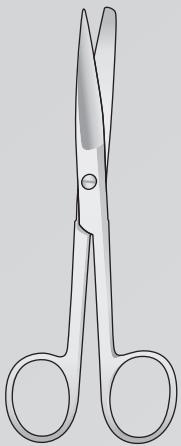

FM-27/FM-62



1/1



1/1

FM-49
115 mm



1/1

FM-27
130 mm



1/1

FM-29
145 mm



1/1

FM-31
165 mm



1/1

FM-33
185 mm



1/1

FM-62
200 mm

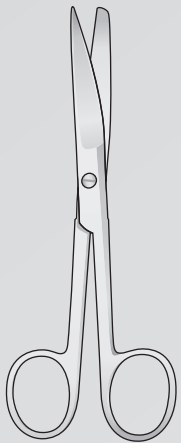

FM-28/FM-63



1/1



1/1

FM-63
115 mm



1/1

FM-28
130 mm

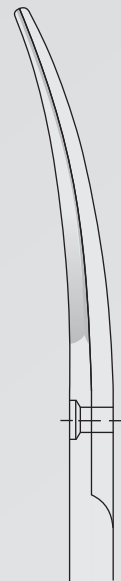

1/1

FM-30
145 mm



1/1

FM-32
165 mm



1/1

FM-34
185 mm

Standard

Stumpf
Blunt
Smusse
Romas
Mousses

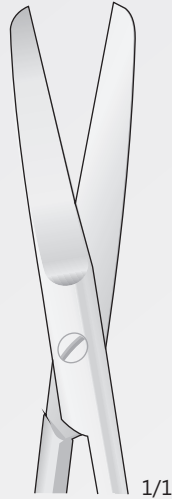
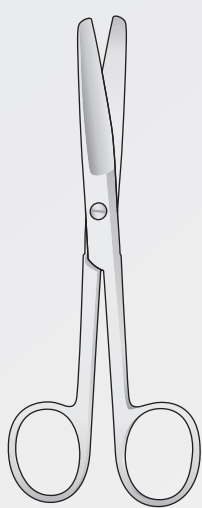

1/1

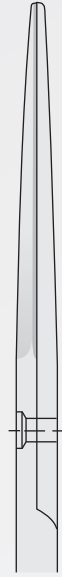

1/1

FM-35
130 mm



1/1

FM-9
145 mm

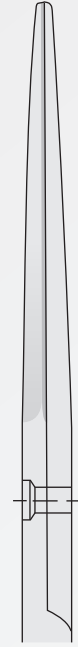

1/1

FM-37
165 mm



1/1

FM-39
185 mm

FM-9/FM-39

Stumpf
Blunt
Smusse
Romas
Mousses

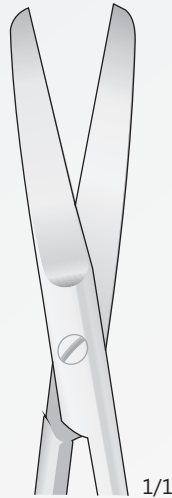
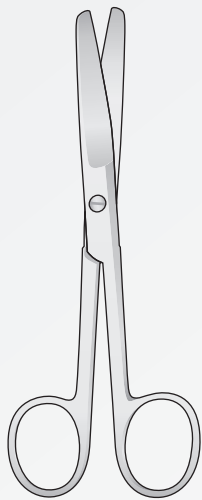

1/1



1/1

FM-36
130 mm



1/1

FM-10
145 mm

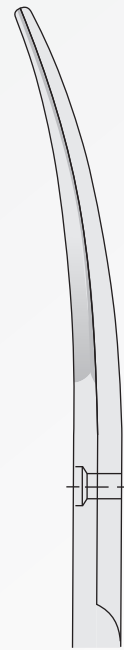

1/1

FM-38
165 mm



1/1

FM-40
185 mm

FM-10/FM-40

Chirurgische scheren
Operating scissors
Forbici chirurgiche
Tijeras para cirugía general
Ciseaux chirurgicaux

Stumpf
Blunt
Smussa
Romo
Moussés

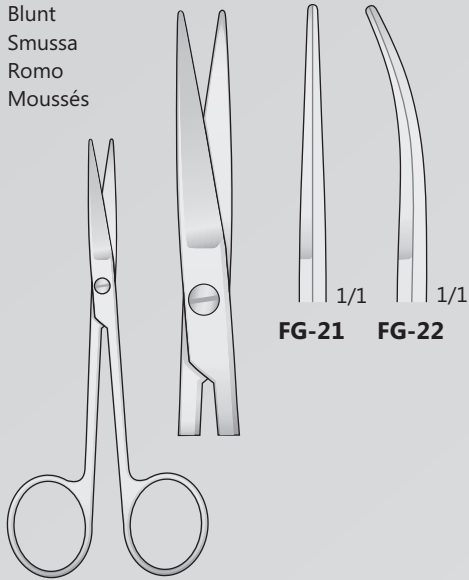

FG-21/FG-22
115 mm

Spitz
Sharp
Acuta
Agudo
Aigu

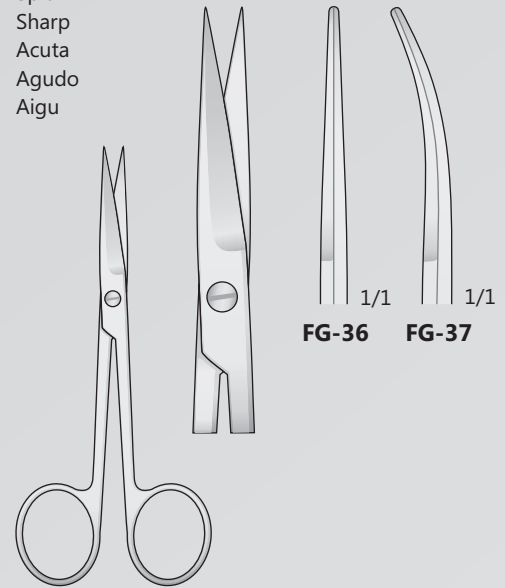

FG-36/FG-37
115 mm

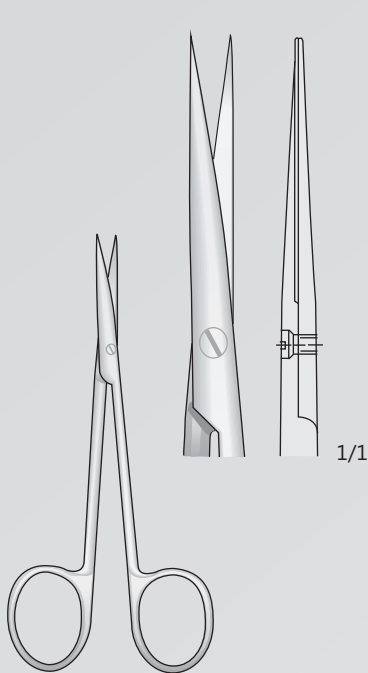

KILNER
FG-58
115 mm

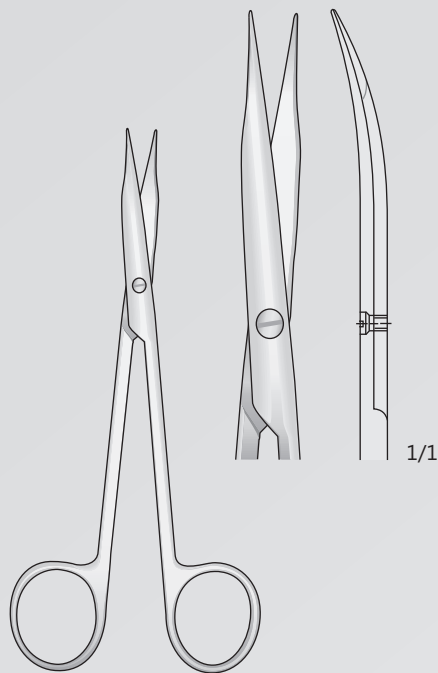

JAMESON
FG-124
145 mm

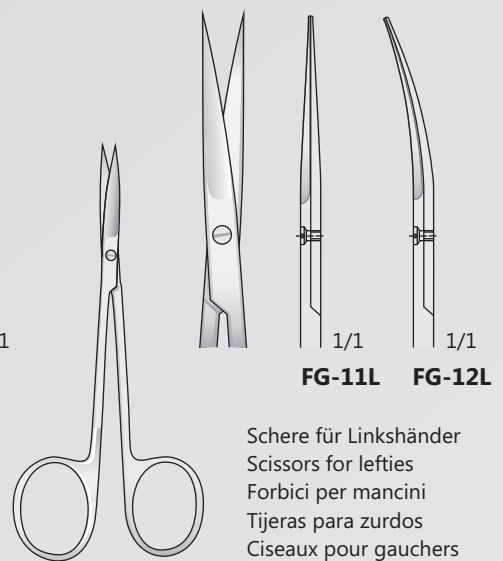

IRIS
FG-11L/FG-12L
110 mm

Schere für Linkshänder
Scissors for lefties
Forbici per mancini
Tijeras para zurdos
Ciseaux pour gauchers

Präparierscheren
Dissecting Scissors
Forbici per dissezione
Tijeras para preparaciones
Ciseaux à dissection

Chirurgische scheren
Operating scissors
Forbici chirurgiche
Tijeras para cirugía general
Ciseaux chirurgicaux

Spitz
Sharp
Acuta
Agudo
Aigu

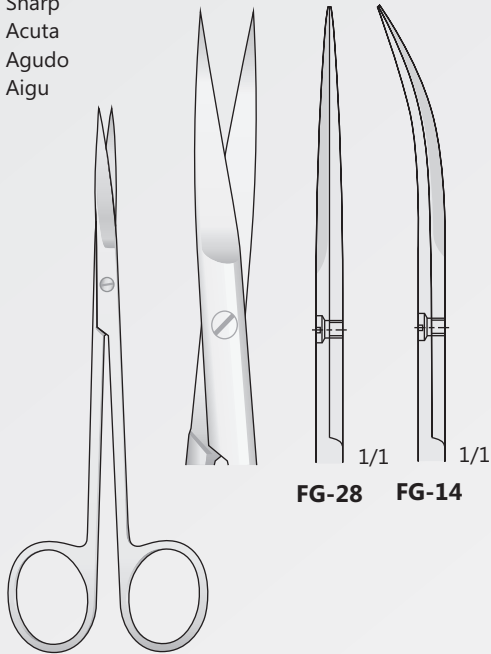

FG-28 FG-14

Spitz
Sharp
Acuta
Agudo
Aigu

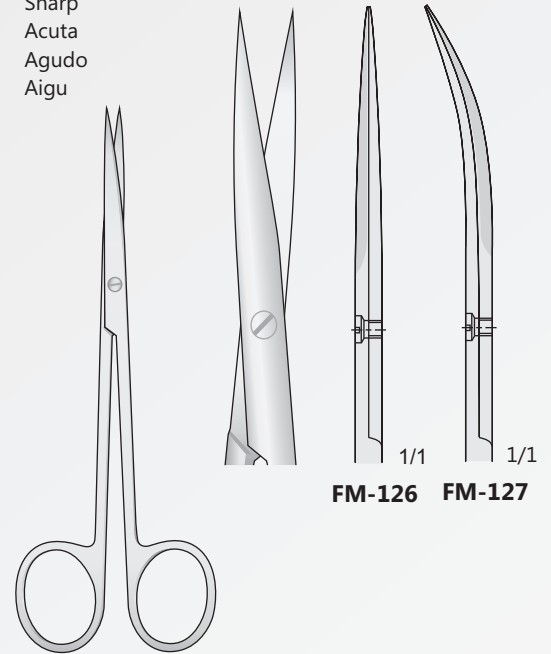

FM-126 FM-127

METZENBAUM
FG-28/FG-14
145 mm

METZENBAUM
FM-126/FM-127
145 mm

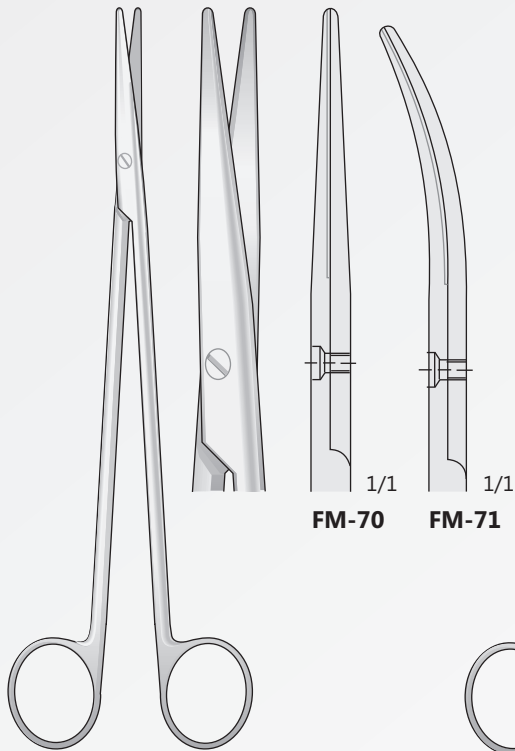

FM-70 FM-71

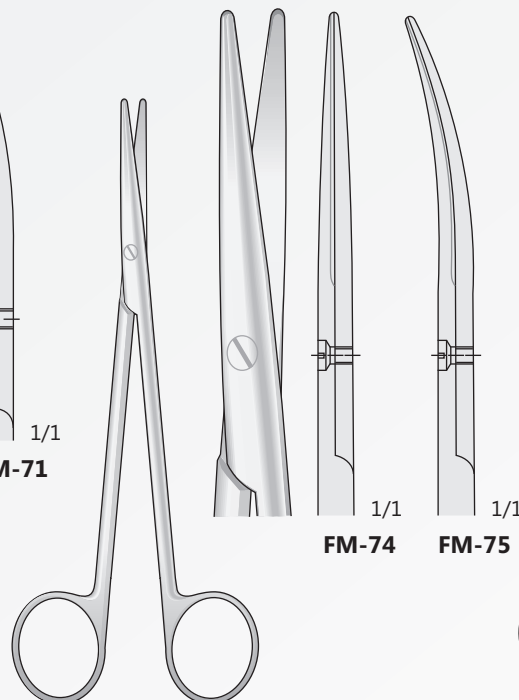

FM-74 FM-75

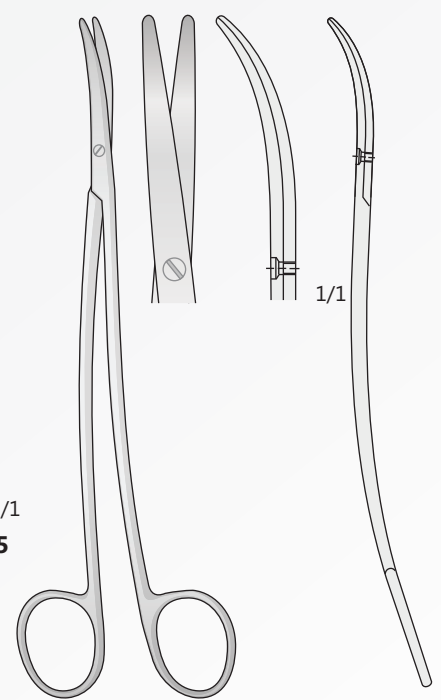

METZENBAUM-FINO
FM-120 - 180 mm
FM-121 - 200 mm
FM-122 - 230 mm

METZENBAUM
FM-70/FM-71
200 mm

METZENBAUM
FM-74/FM-75
160 mm

Chirurgische scheren
Operating scissors
Forbici chirurgiche
Tijeras para cirugía general
Ciseaux chirurgicaux

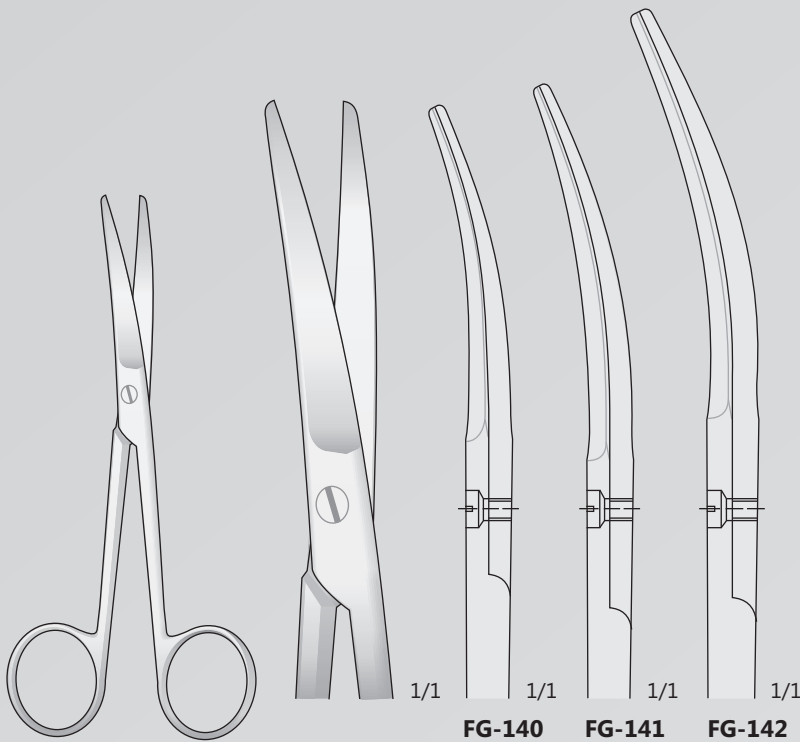

FG-140 145 mm
FG-141 200 mm
FG-142 230 mm

WERTHEIM
FG-140/FG-142



KELLY
FK-10
160 mm

Mit einer Schneide gezahnt
With one blade serrated
Con una lama dentellata
Con una hoja dentada
Avec une lame dentèle

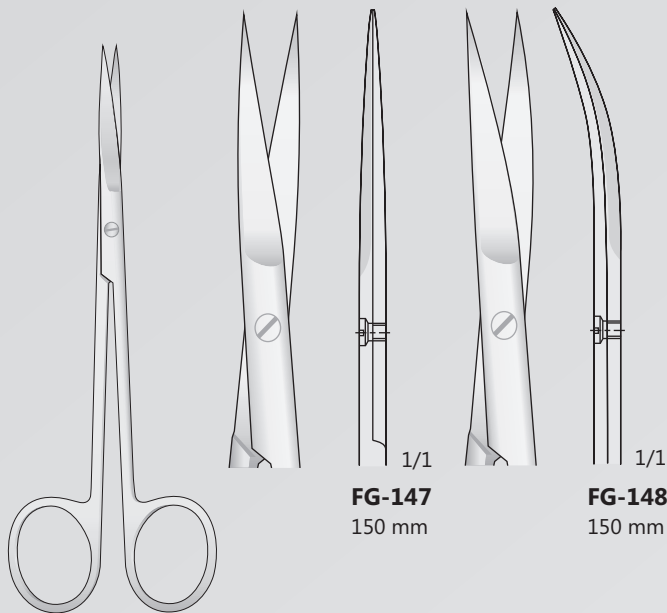

FG-147 150 mm
FG-148 150 mm

JOSEPH
FG-147/FG-148
150 mm

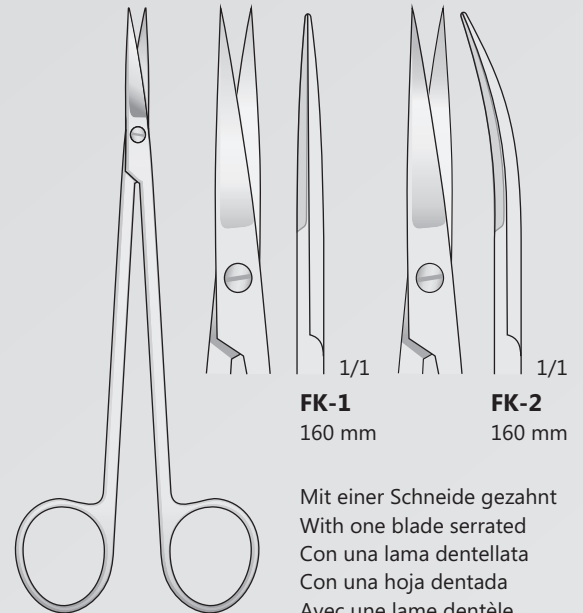

FK-1 160 mm
FK-2 160 mm

KELLY
FK-1/FK-2

Mit einer Schneide gezahnt
With one blade serrated
Con una lama dentellata
Con una hoja dentada
Avec une lame dentèle

Präparierscheren
Dissecting Scissors
Forbici per dissezione
Tijeras para preparaciones
Ciseaux à dissection

Chirurgische scheren
Operating scissors
Forbici chirurgiche
Tijeras para cirugía general
Ciseaux chirurgicaux

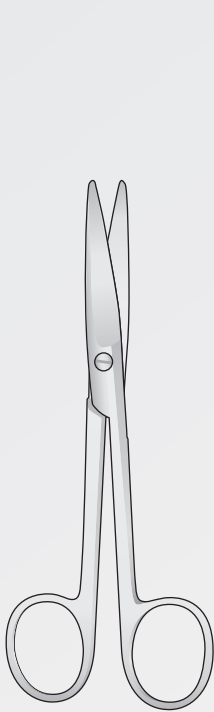

MAYO
FM-5/FM-25

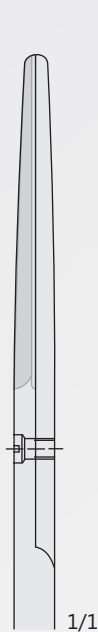

FM-5
140 mm

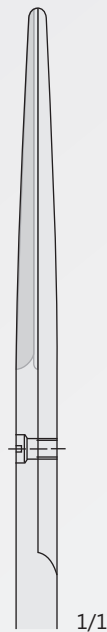

FM-24
170 mm

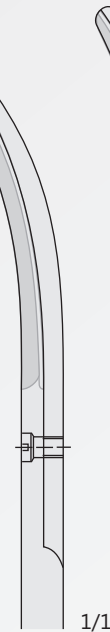

FM-6
140 mm



FM-25
170 mm

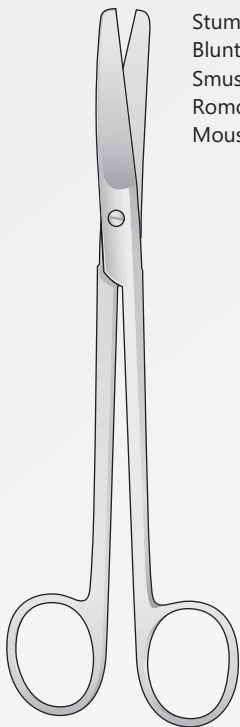

SIMS
FM-20/FM-23

Stumpf
Blunt
Smussa
Romo
Moussés

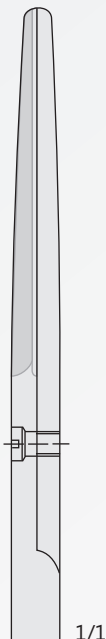
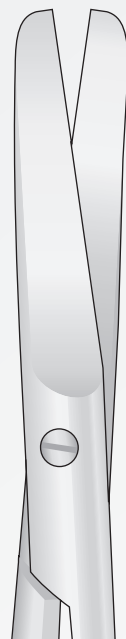

FM-20
200 mm

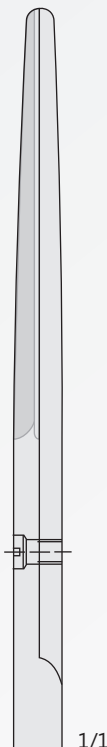

FM-22
230 mm

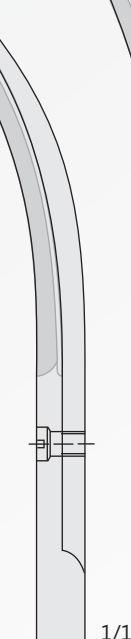

FM-21
200 mm

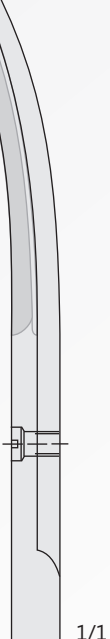

FM-23
230 mm

Chirurgische scheren
Operating scissors
Forbici chirurgiche
Tijeras para cirugía general
Ciseaux chirurgicaux

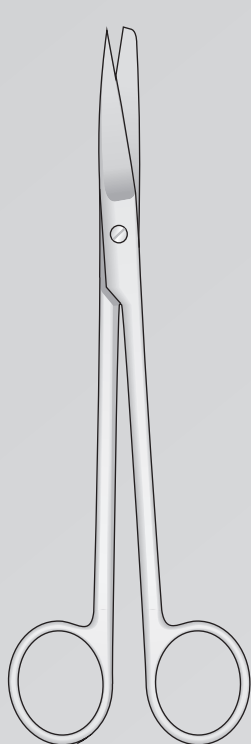

SIMS
FM-14/FM-17

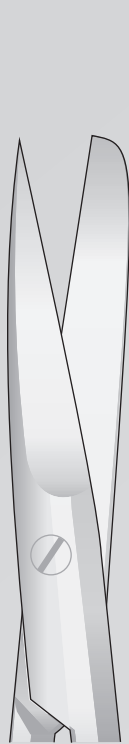

FM-14
200 mm

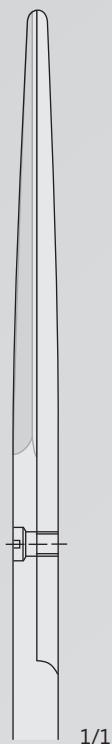

FM-16
230 mm

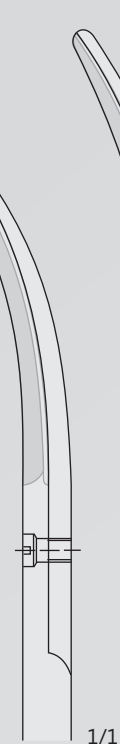

FM-15
200 mm

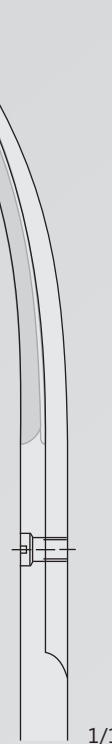

FM-17
230 mm

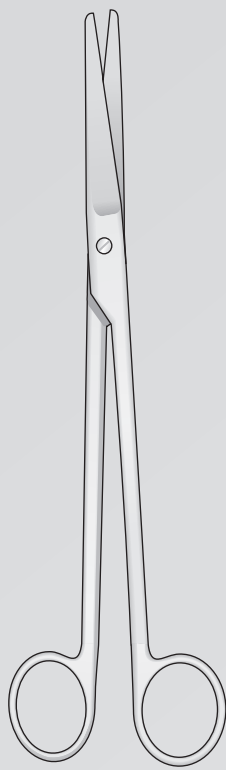

MAYO-HARRINGTON
FM-18/FM-19
230 mm

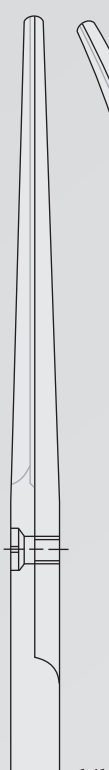
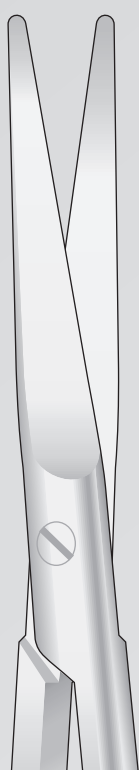

FM-18
230 mm

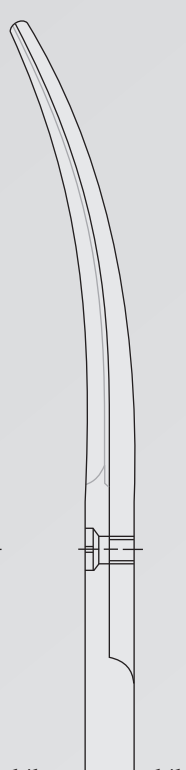

FM-19
230 mm

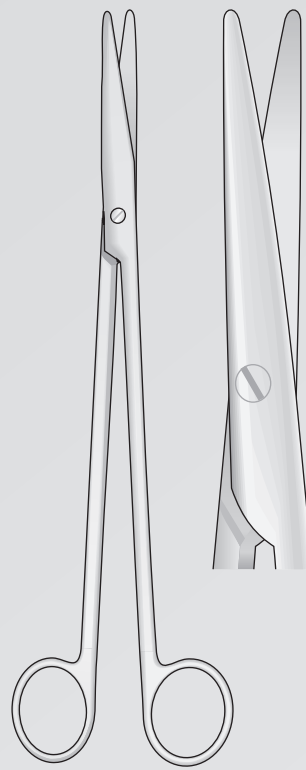

NELSON-METZENBAUM
FM-11/FM-13
230 mm

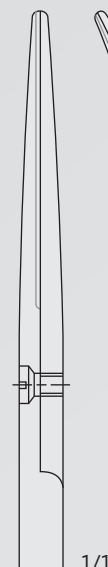

FM-11
230 mm



FM-13
230 mm

Präparierscheren
Dissecting Scissors
Forbici per dissezione
Tijeras para preparaciones
Ciseaux à dissection

Chirurgische scheren
Operating scissors
Forbici chirurgiche
Tijeras para cirugía general
Ciseaux chirurgicaux

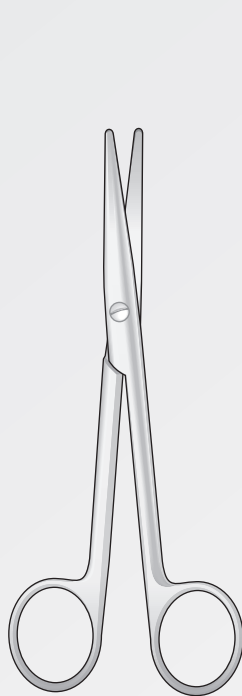

FM-110
150 mm



1/1



FM-111
150 mm



1/1

STILLE
FM-110/FM-111
150 mm

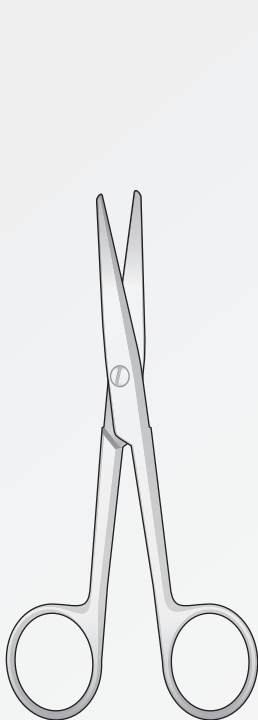

1/1

FM-76
140 mm

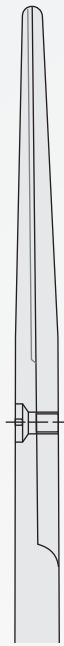

1/1

FM-77
170 mm

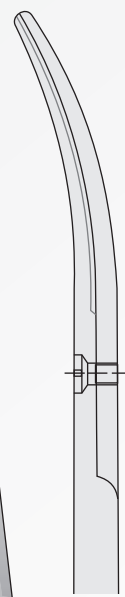

1/1

FM-78
140 mm

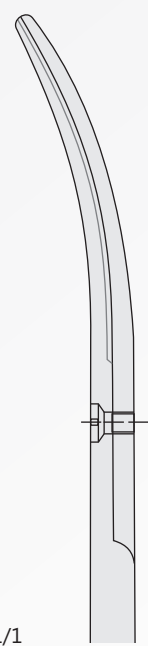

1/1

FM-79
170 mm

MAYO-STILLE
FM-76/FM-79

Chirurgische scheren
Operating scissors
Forbici chirurgiche
Tijeras para cirugía general
Ciseaux chirurgicaux

Präparierschere
Dissecting Scissors
Forbici per dissezione
Tijeras para preparaciones
Ciseaux à dissection

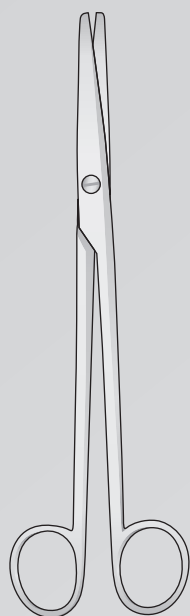

MAYO
FM-80/FM-82

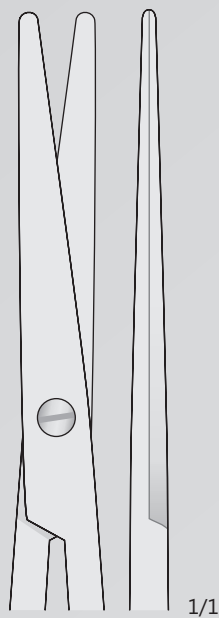

FM-80
160 mm

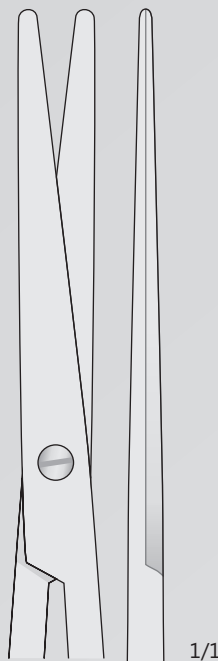

FM-81
190 mm



FM-82
210 mm

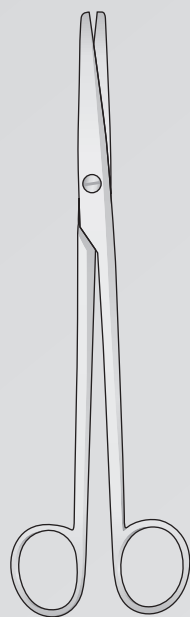

MAYO
FM-83/FM-85

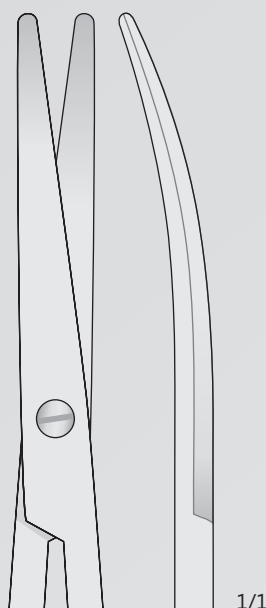

FM-83
160 mm

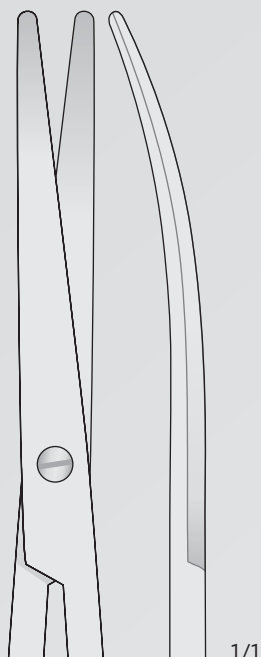

FM-84
190 mm

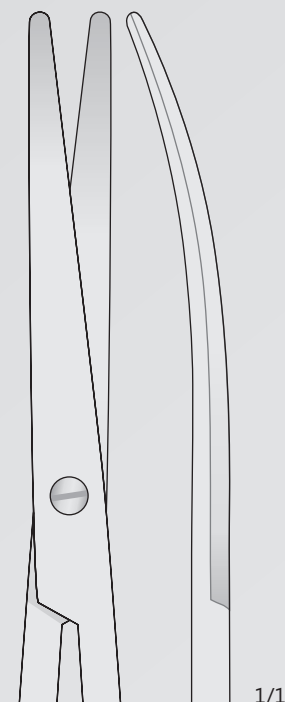

FM-85
210 mm

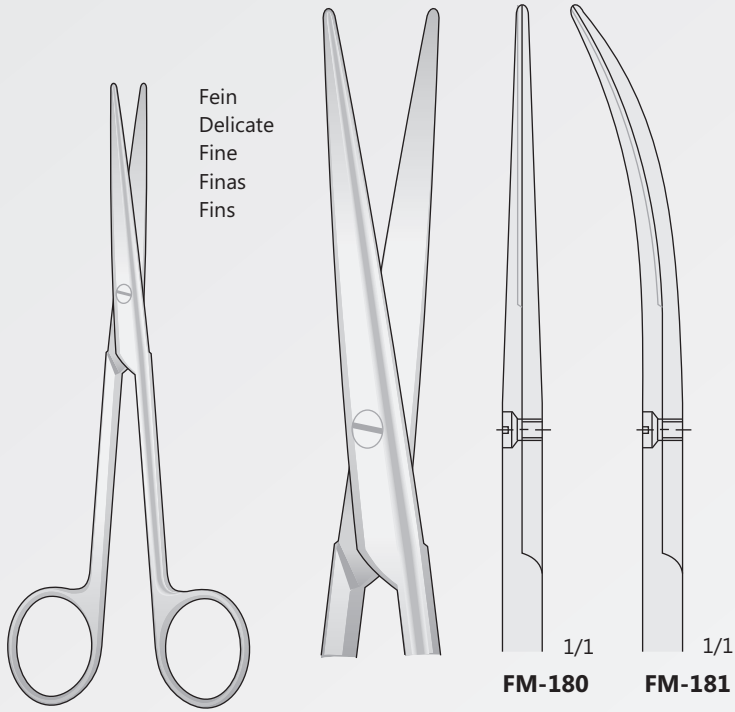

LEXER
FM-180/FM-181
165 mm

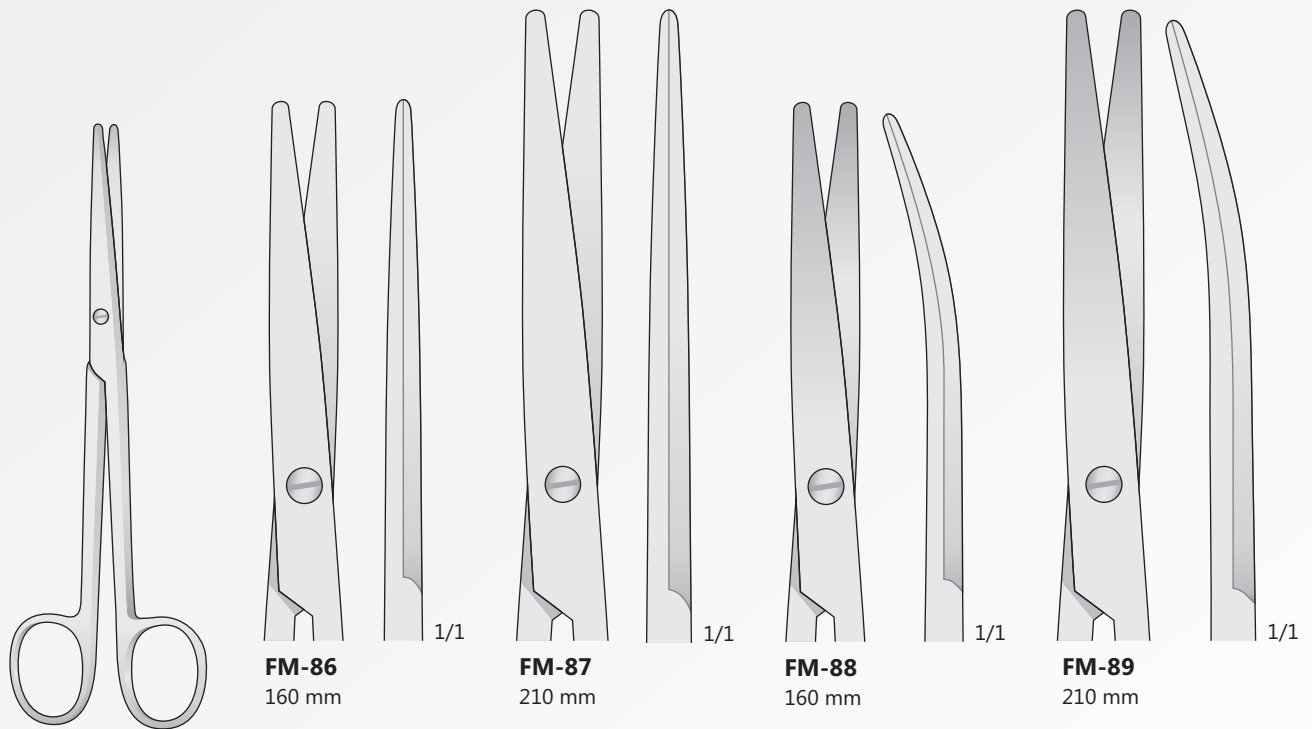

LEXER
FM-86/FM-89

Gefäss Scheren
Vascular scissors
Forbici vascolari
Tijeras vasculares
Ciseaux vasculaires

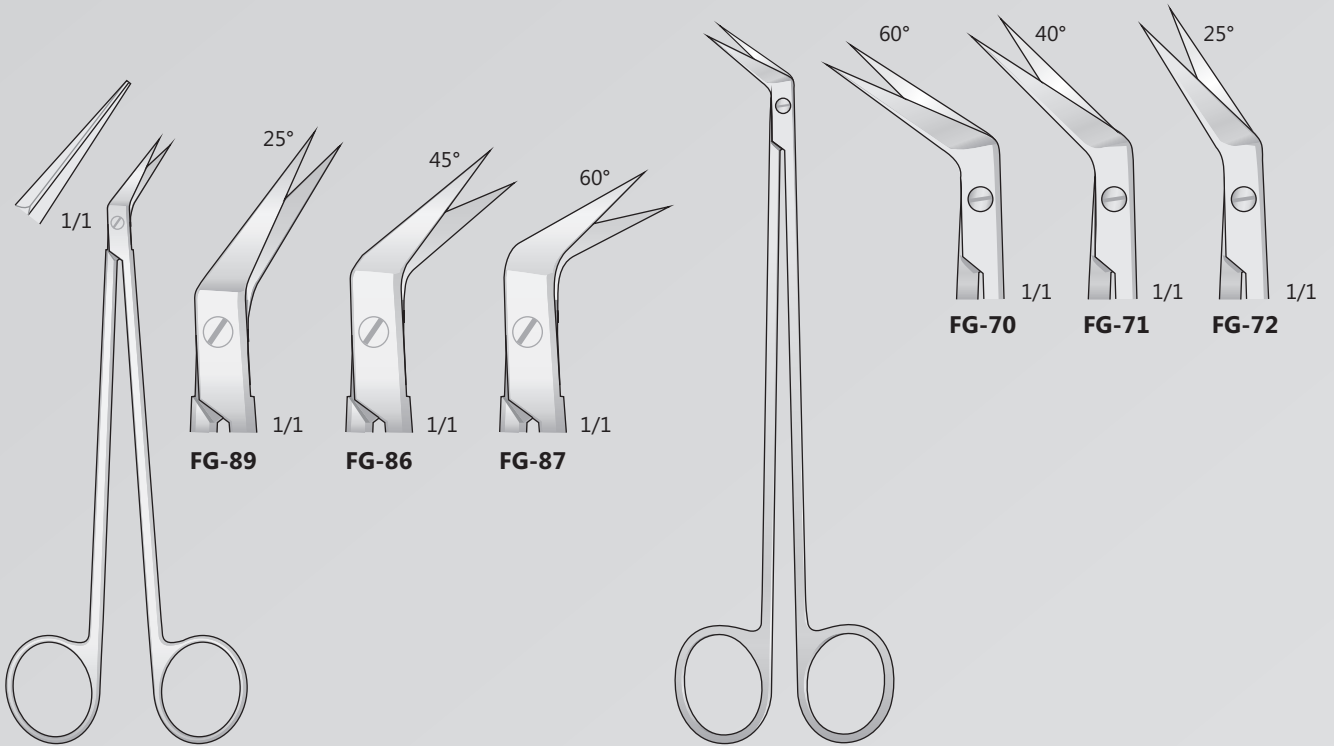

DE BAKEY (POTTS-SMITH)
FG-86/FG-89
160 mm

POTTS-SMITH
FG-70/FG-72
190 mm

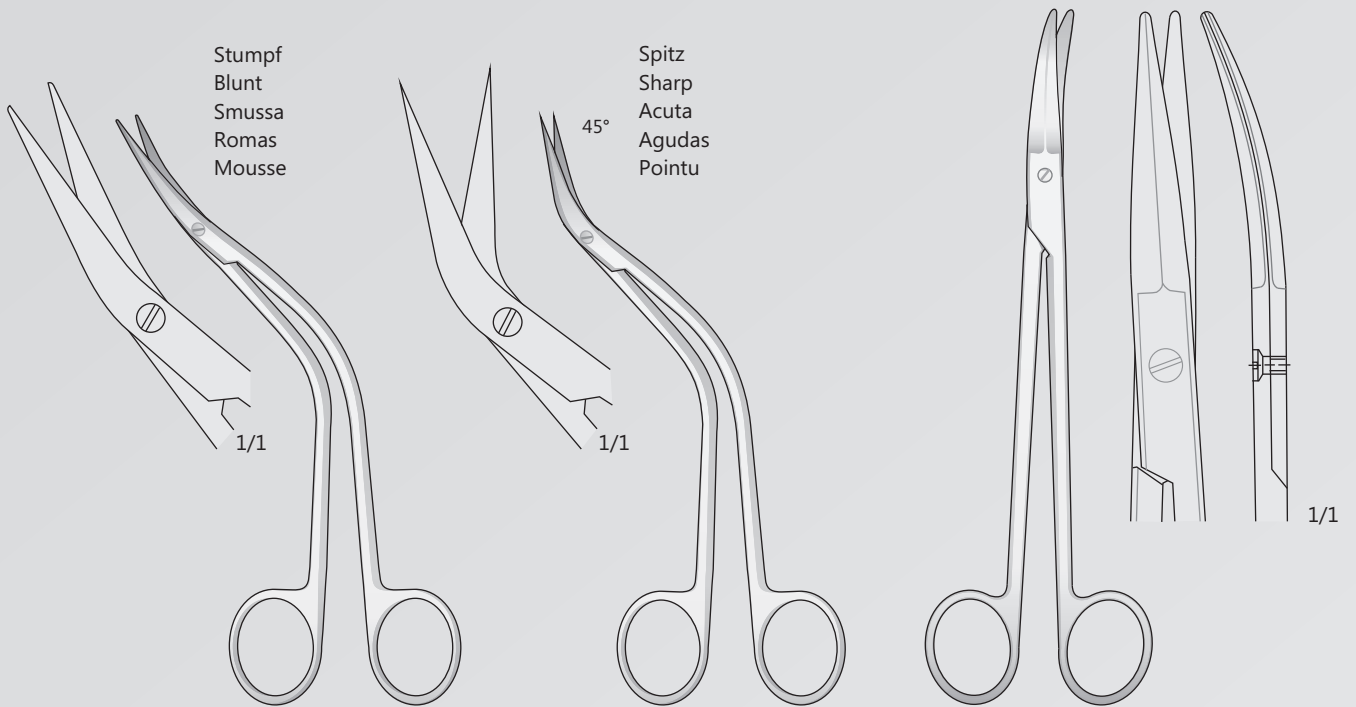

Stumpf
Blunt
Smussa
Romas
Mousse

Spitz
Sharp
Acuta
Agudas
Pointu

DE BAKEY
FG-78
155 mm

DE BAKEY
FG-79
155 mm

FG-10
185 mm

Chirurgische scheren
Operating scissors
Forbici chirurgiche
Tijeras para cirugía general
Ciseaux chirurgicaux

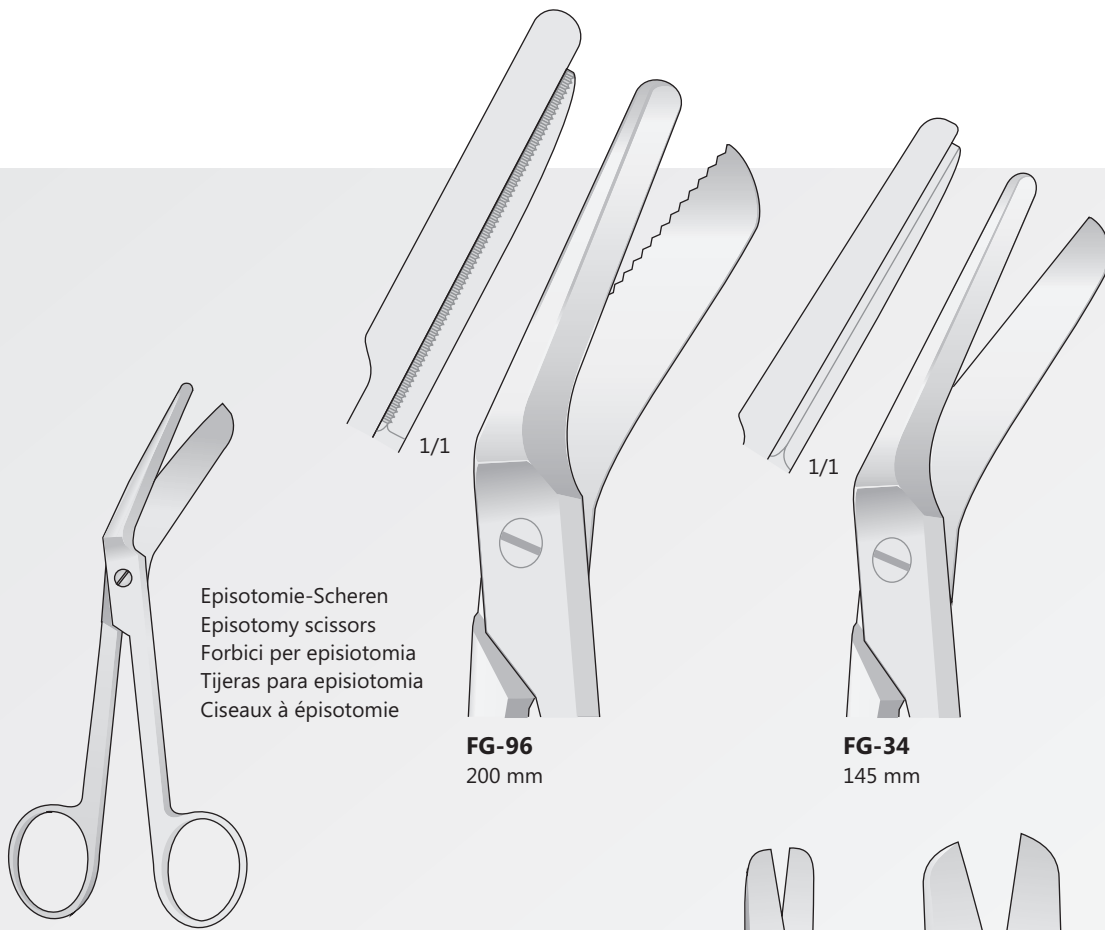

Episotomie-Scheren
Episotomy scissors
Forbici per episiotomia
Tijeras para episiotomia
Ciseaux à épisotomie

FG-96
200 mm

FG-34
145 mm

BRAUN-STADLER
FG-34/FG-96

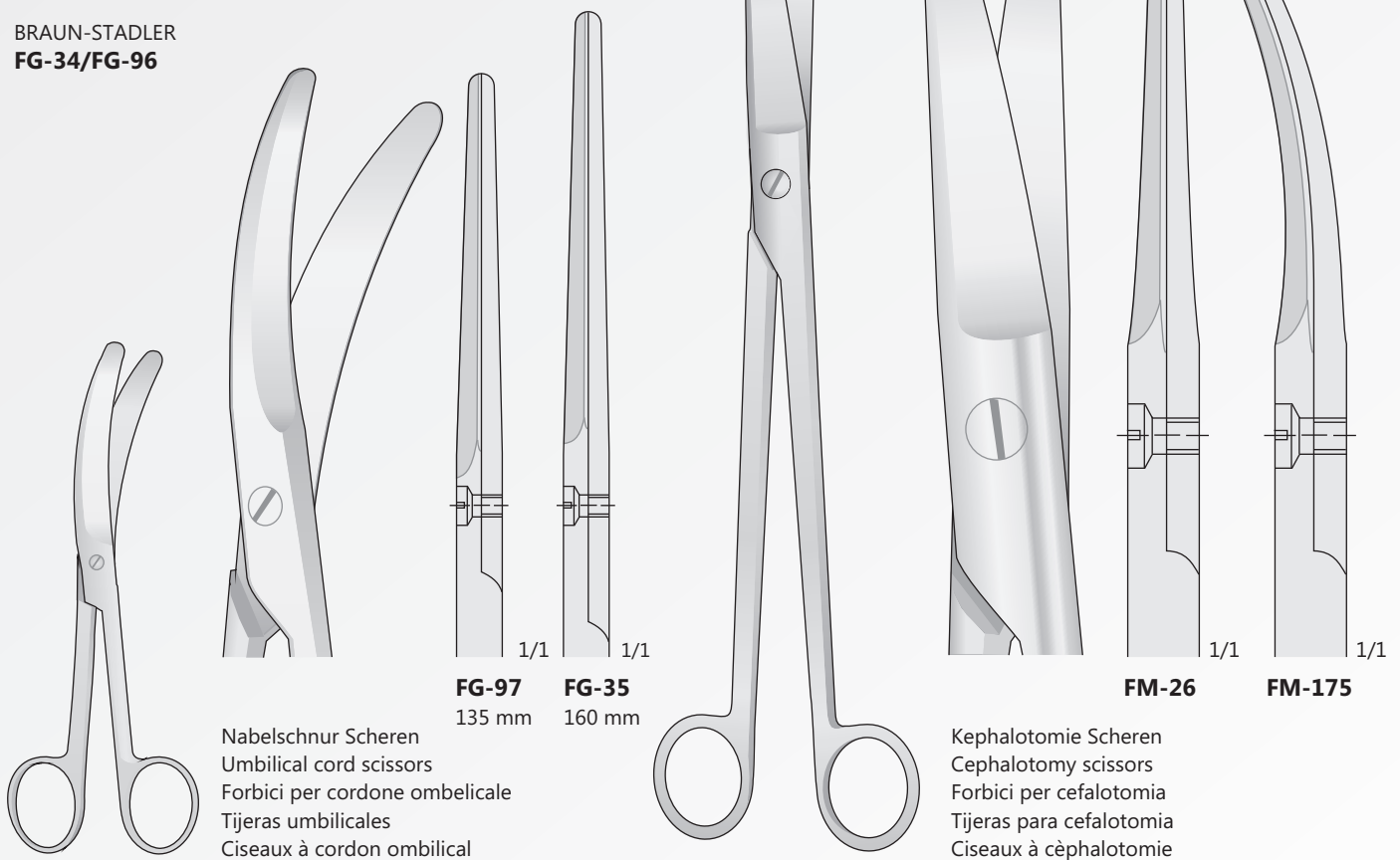

Nabelschnur Scheren
Umbilical cord scissors
Forbici per cordone ombelicale
Tijeras umbilicales
Ciseaux à cordon ombilical

FG-97
135 mm

FG-35
160 mm

Kephalotomie Scheren
Cephalotomy scissors
Forbici per cefalotomia
Tijeras para cefalotomia
Ciseaux à céphalotomie

FM-26

FM-175

FG-35/FG-97

DUBOIS
FM-26/FM-175
270 mm

Chirurgische scheren
Operating scissors
Forbici chirurgiche
Tijeras para cirugía general
Ciseaux chirurgicaux

Fein
Delicate
Fine
Finas
Fins

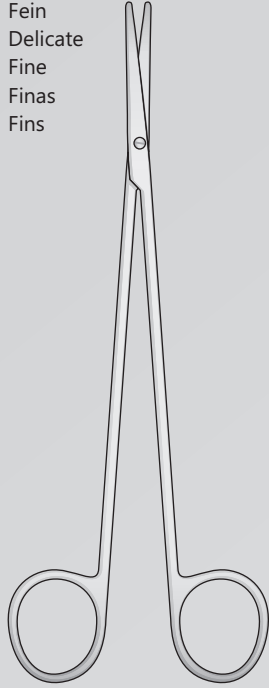

TOENNIS-ADSON
FG-60/FG-61
180 mm



FG-60
180 mm

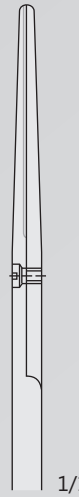

1/1



FG-61
180 mm

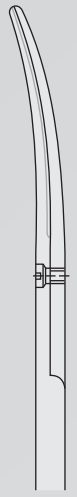

1/1

Gezahnt
Serrated
Dentellate
Dentadas
Dentelé

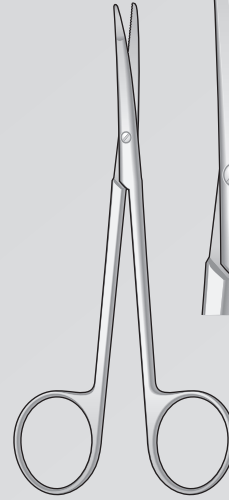

KILNER
FG-121
130 mm



1/1

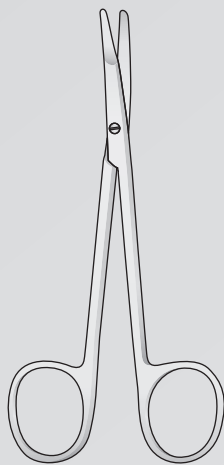

KILNER (RAGNELL)
FG-6C/FG-67

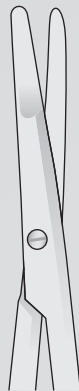

FG-66
120 mm



FG-19R
135 mm



FG-6R
150 mm



FG-67
120 mm



FG-19C
135 mm



FG-6C
150 mm

Verband Scheren
Bandage scissors
Forbici per bendaggi
Tijeras para vendajes
Ciseaux à bandages

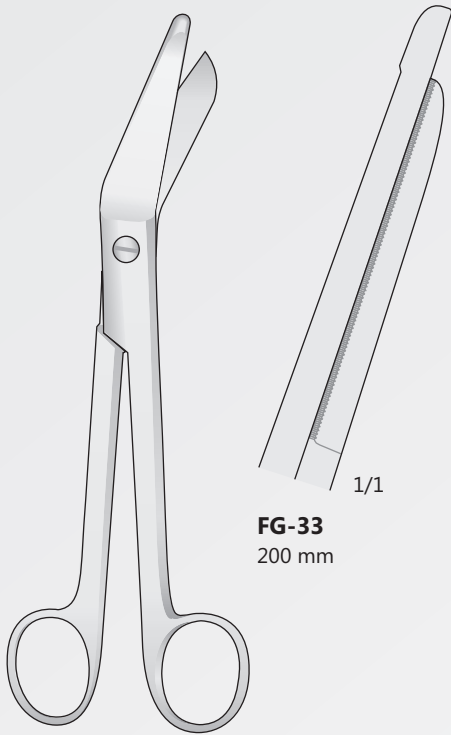

FG-33
200 mm

ESMARCH
FG-33

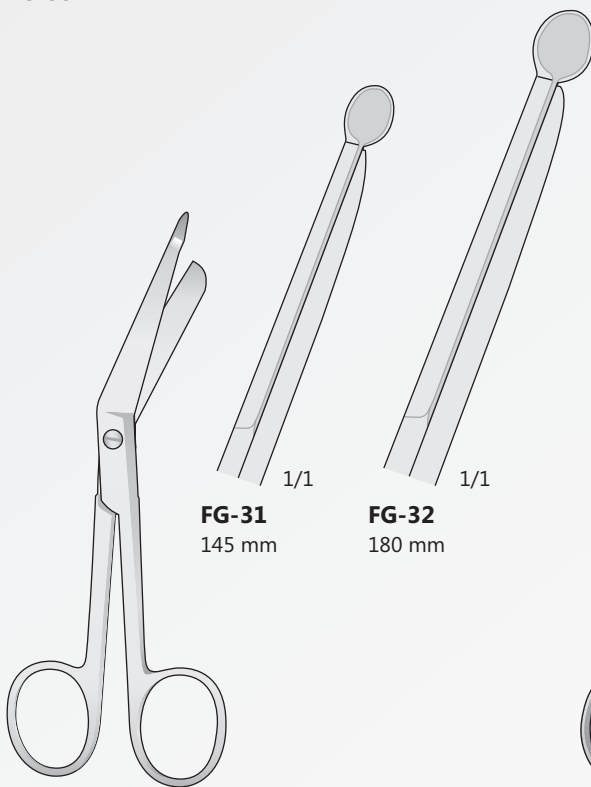

FG-31
145 mm

FG-32
180 mm

LISTER
FG-31/FG-32

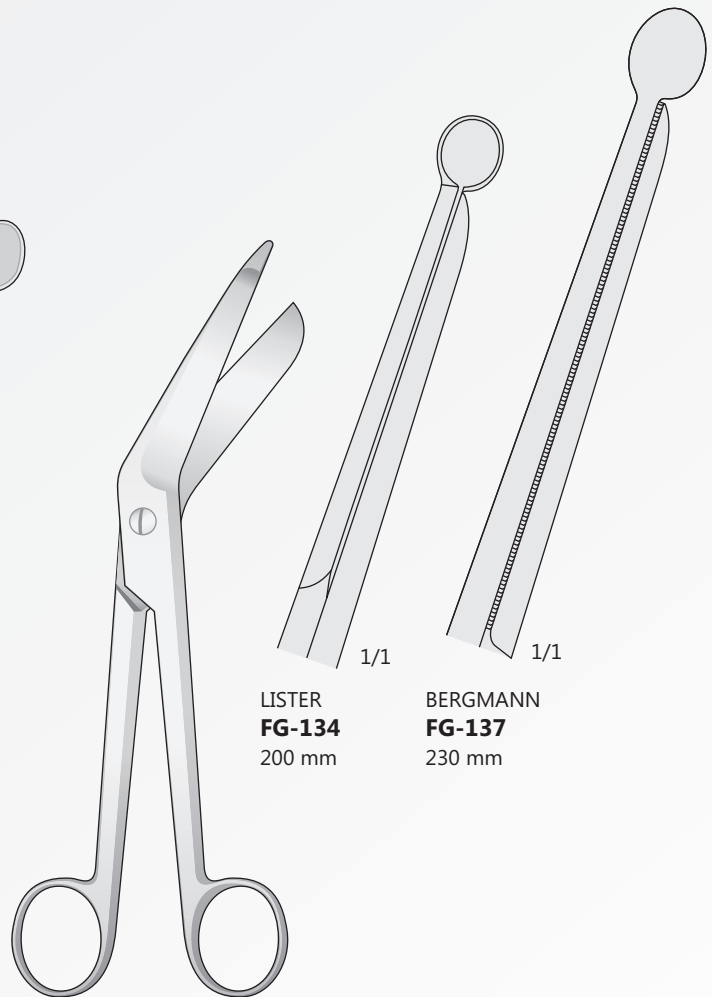

LISTER
FG-134
200 mm

BERGMANN
FG-137
230 mm

FG-134/FG-137

Ligatur Scheren
Ligature Scissors
Forbici per legature
Tijeras para ligaduras
Ciseaux à ligatures

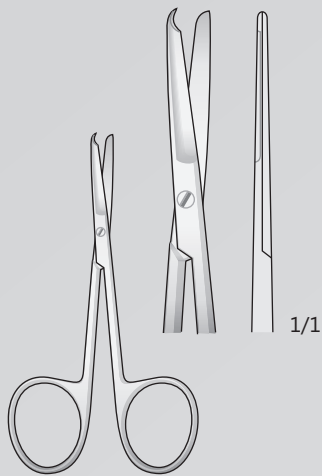

SPENCER
SC-9
90 mm

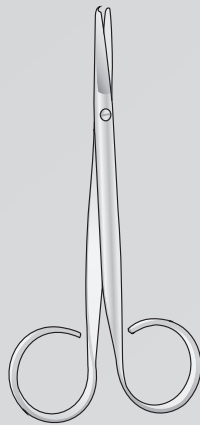

SPENCER
SC-1
110 mm

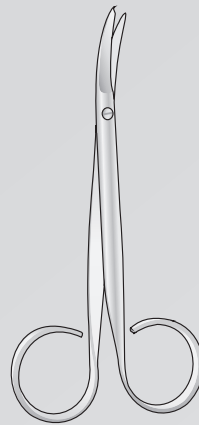

SPENCER
SC-5
110 mm



SPENCER
SC-2
145 mm

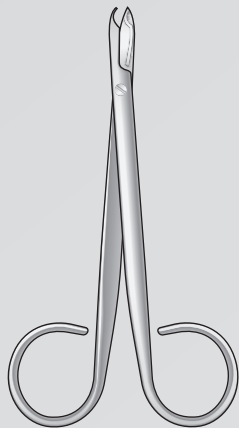

SC-3
110 mm

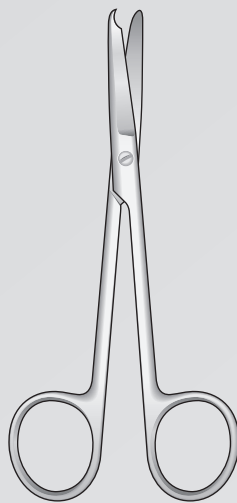

SPENCER
SC-14
120 mm

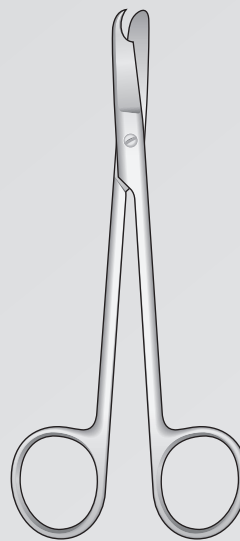

LITTAUER
SC-15
140 mm

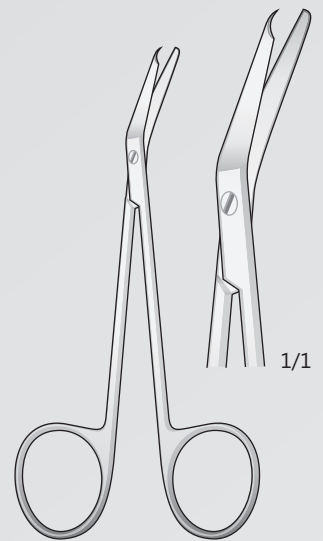

SPENCER
SC-13
130 mm

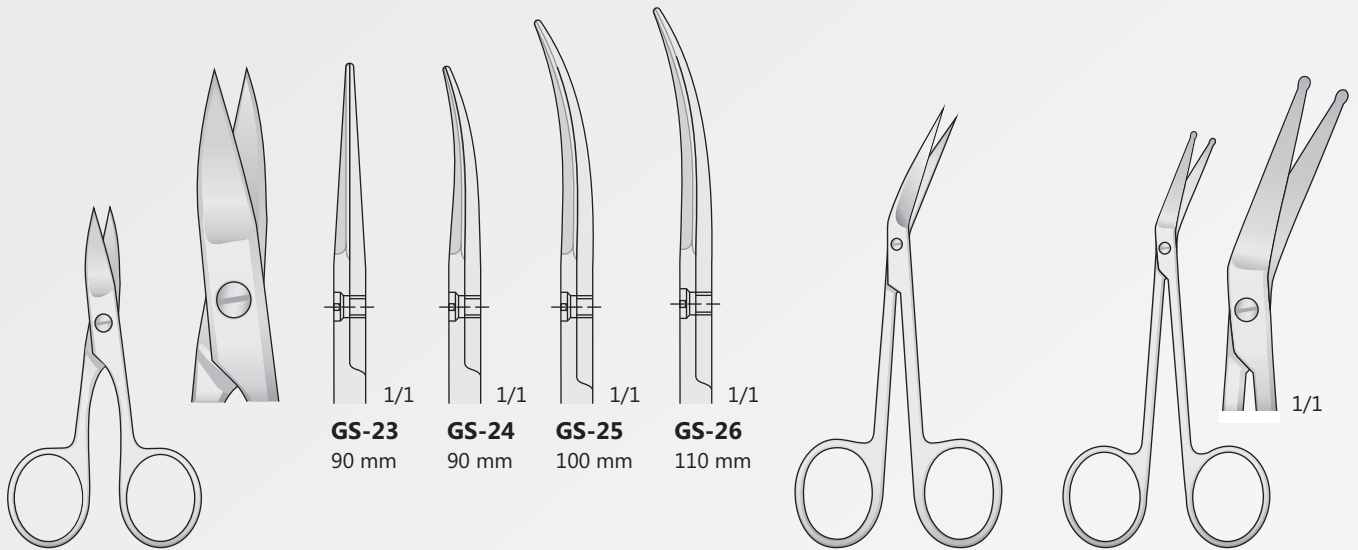

GS-23/GS-26

LK-1
115 mm

LOCKLIN MOD.
LK-3
110 mm

Mit einem gezackten Klinge
With a serrated blade
Con una lama dentellata
Con una hoja de sierra
Avec une lame dentelée

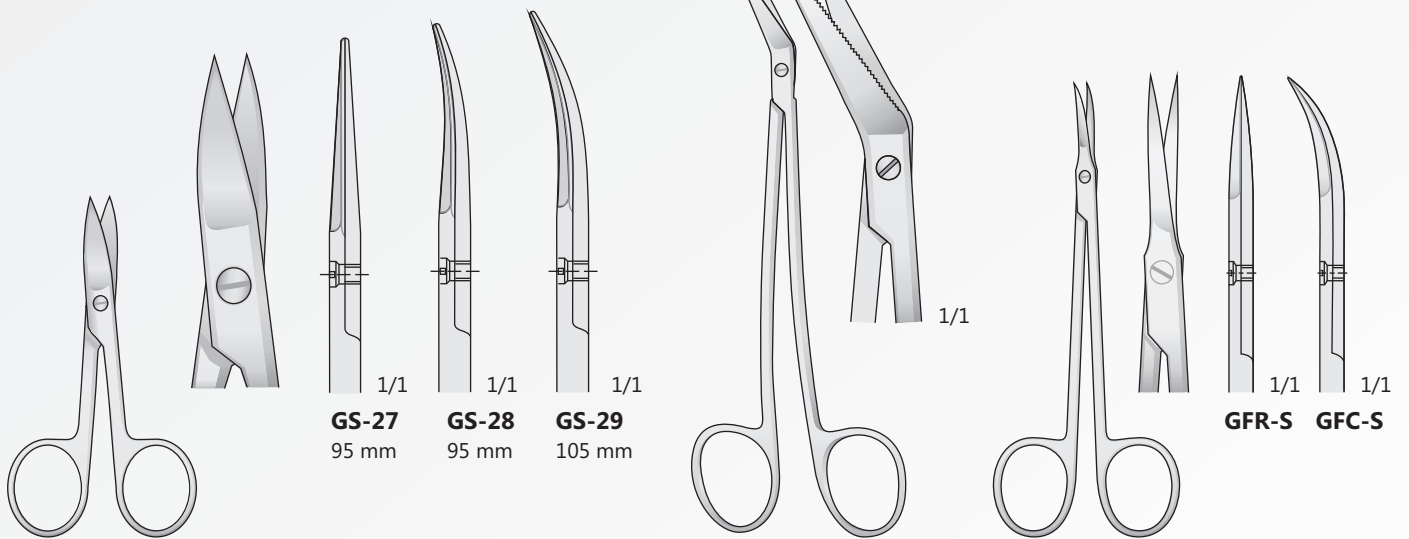

GS-27/GS-29

LOCKLIN
LK-2
160 mm

GFR-S/GFC-S
120 mm

Klammeranlegepinzette
Clips applying and Removing Forceps
Pinze metti e toglì clips
Pinzas para ponery quitar agrafes
Pincas à poser et retirer les agrafes

 1/1

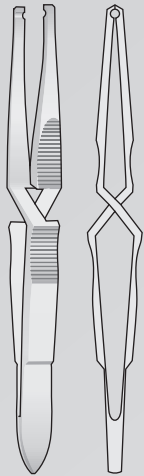

HEGENBARTH
BD-52
125 mm

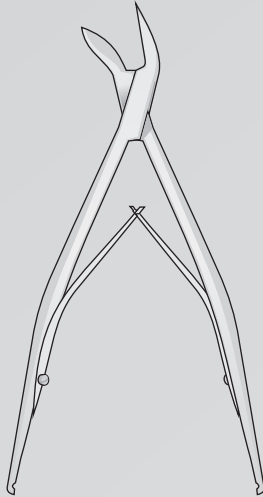

MICHEL
BF-68
130 mm

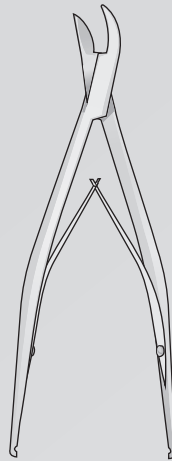

MICHEL
BF-69
120 mm

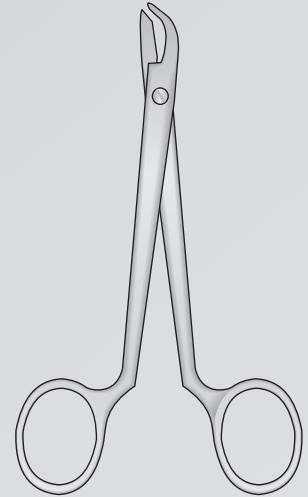

COLLIN
BF-65
135 mm

Nagelzangen
Nail cutters
Tronchesi per unghie
Pinzas para uña
Pince à ongles

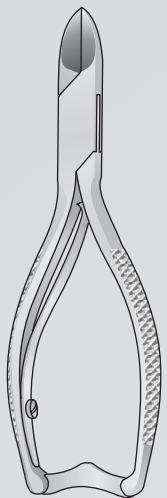

GS-20
135 mm

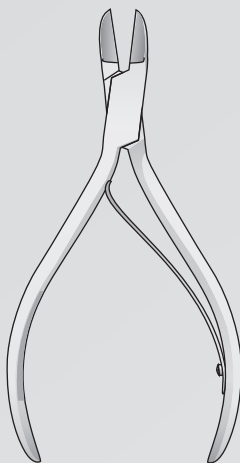

GS-21
120 mm

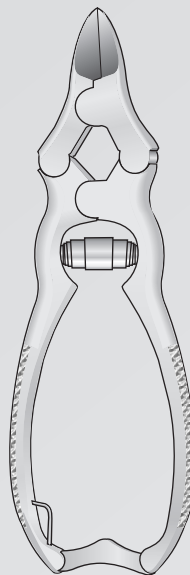

GS-22
155 mm

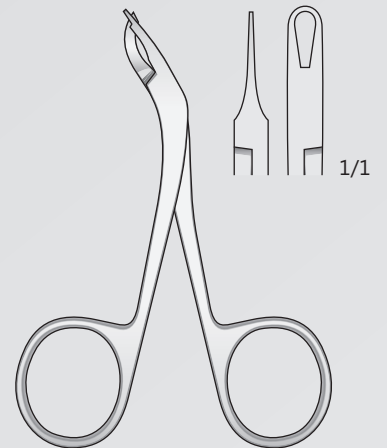

BF-64
115 mm

Pinzette zum Entfernen von Drähten
Tweezers for removing wires
Pinza per rimozione punti metallici
Pinzas para la eliminación de cables
Pince à épiler pour enlever les fils



BONTEMPI
CHIRURGISCHE INSTRUMENTE

Pinzetten
Forceps
Pinzette
Pinzas
Pinces

Micro Pinzetten
Delicate forceps
Micro pinzette
Pinzas finos
Micro pincers

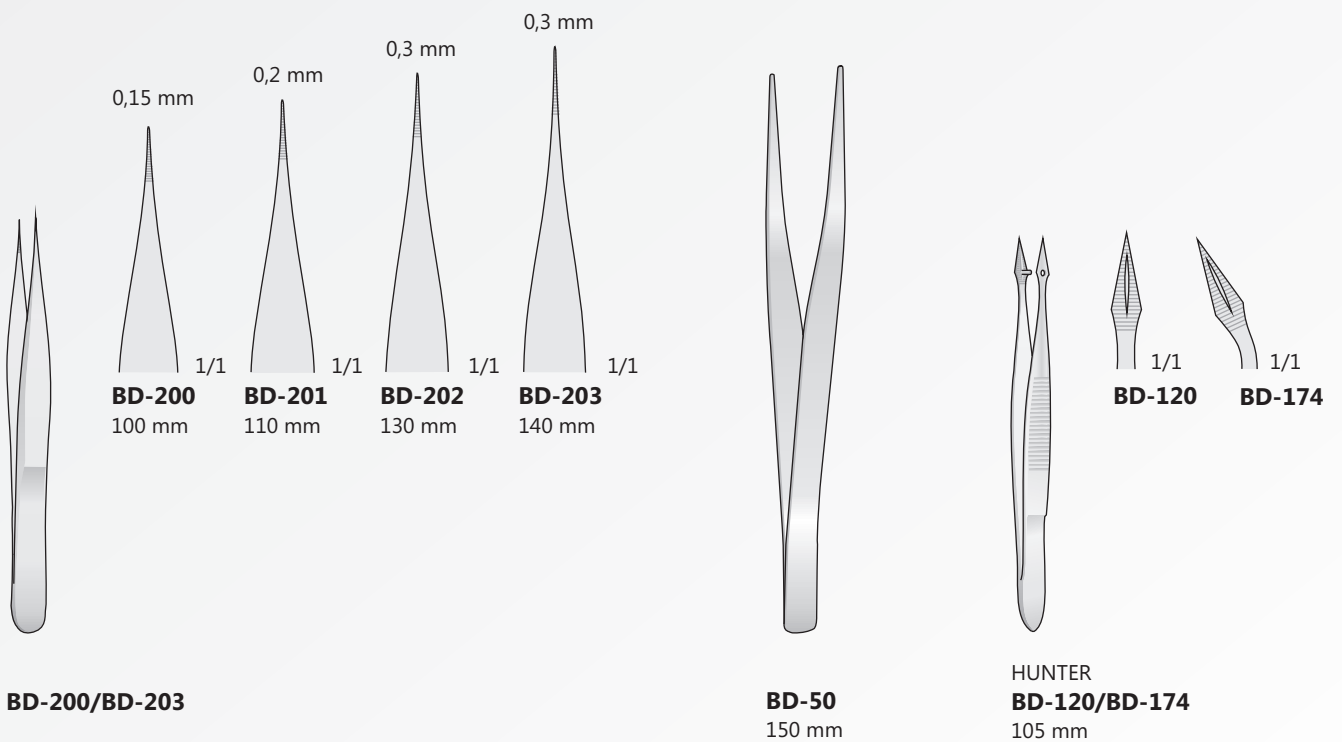
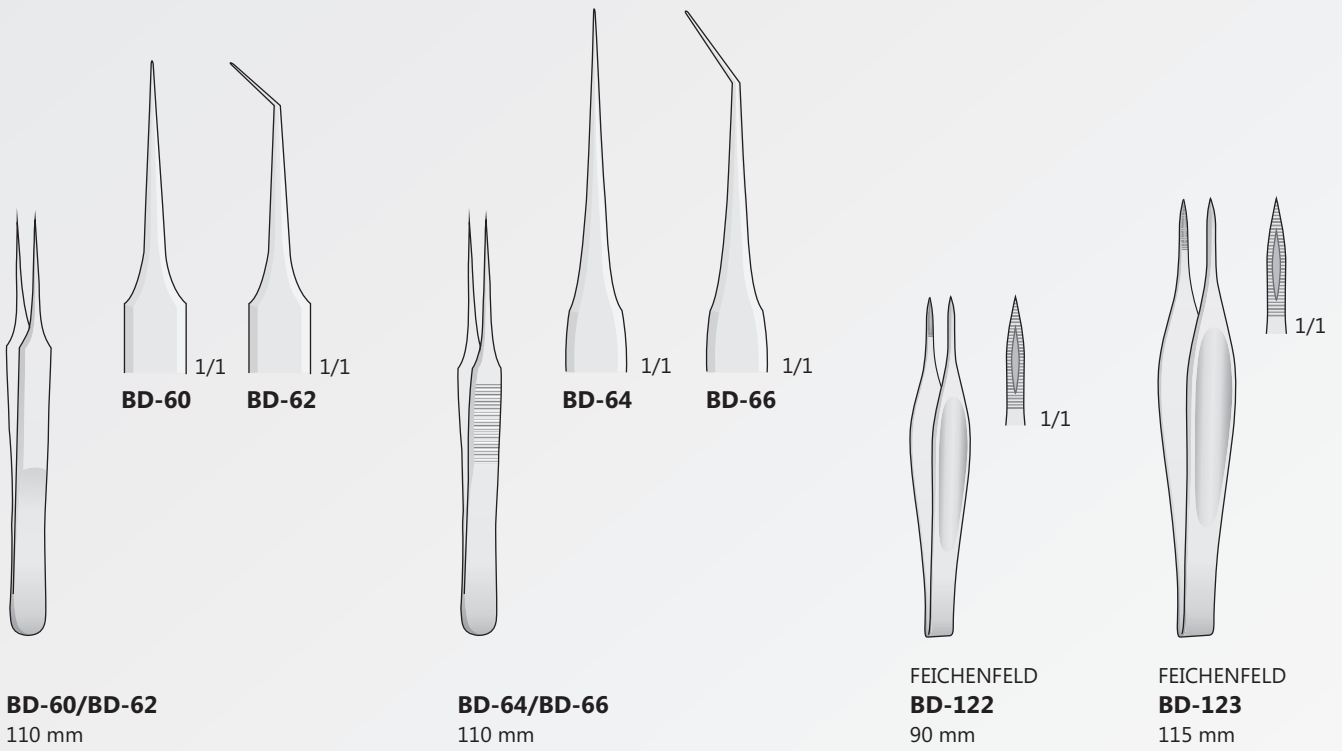

Chirurgische pinzette
Tissue forceps
Pinzette chirurgiche
Pinzas quirùgicas
Pincas chirurgicales



BD-32 **BD-33**

BD-32/BD-33
100 mm

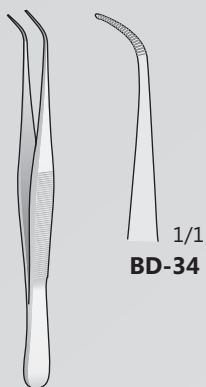

BD-34

BD-34
100 mm



BD-35 **BD-36**

BD-35/BD-36
100 mm

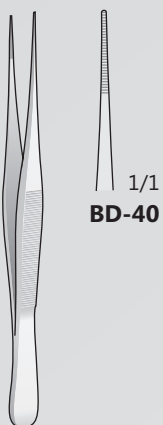

BD-40

BD-40
110 mm

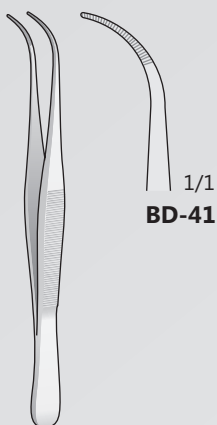

BD-41

BD-41
110 mm

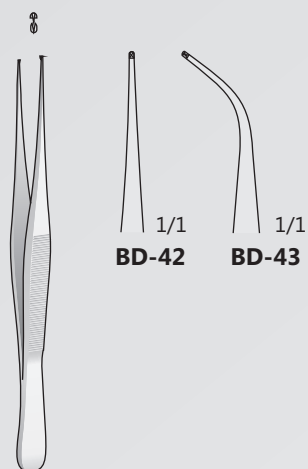

BD-42 **BD-43**

BD-42/BD-43
110 mm

Chirurgische pinzetten
Tissue forceps
Pinzette chirurgiche
Pinzas quirúrgicas
Pincas quirúrgicas

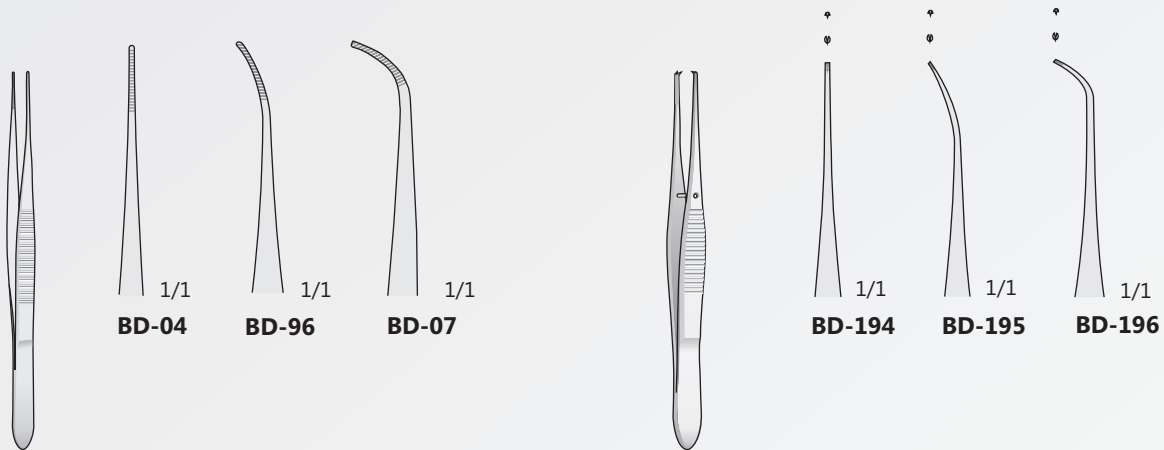

GRAEFE
BD-04/BD-96
100 mm

GRAEFE
BD-194/BD-196
100 mm

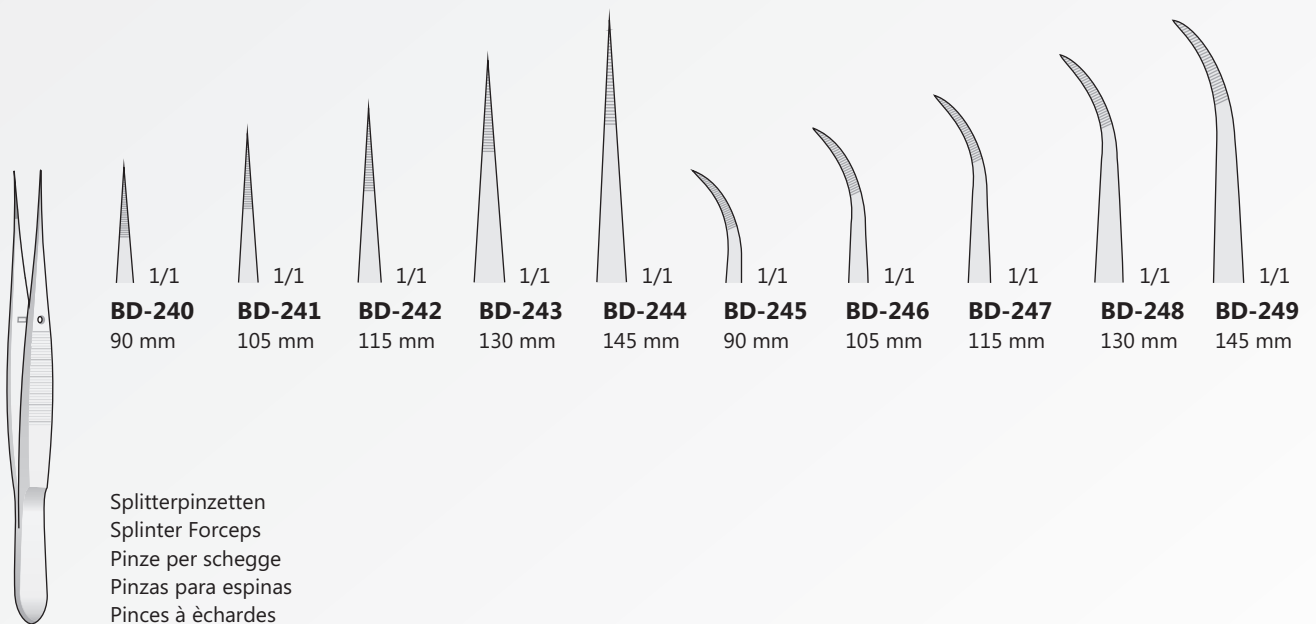

Splitterpinzetten
Splinter Forceps
Pinze per schegge
Pinzas para espinas
Pincas à échardes

BD-240/BD-249

Chirurgische pinzetten
Tissue forceps
Pinzette chirurgiche
Pinzas quirùgicas
Pincas quirurgicales

Fixier und fasspinzetten
Fixation and Grasping forceps
Pinze da fissazione oftalmica
Pinzas de fijaciòn y de apreheñsiòn
Pince de fixation ophtalmique

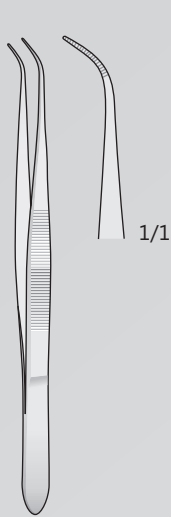

PERRY
BD-05
125 mm

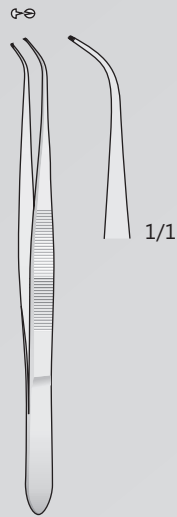

PERRY
BD-06
125 mm

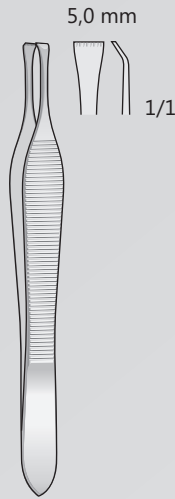

BEASLEY-BABCOCK
BD-51
120 mm

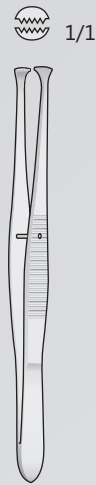

GRAEFE
BD-135
110 mm

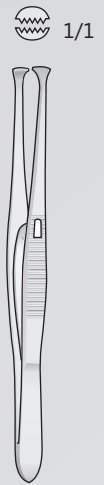

GRAEFE
BD-136
110 mm

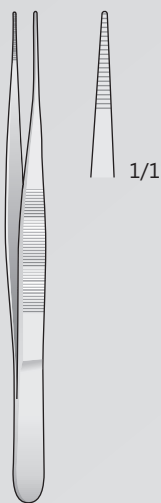

BD-145
130 mm

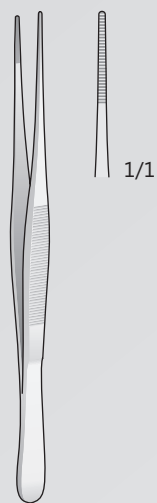

SEMKEN
BD-44
130 mm

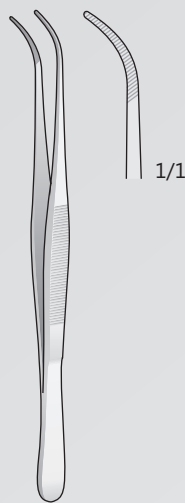

SEMKEN
BD-45
130 mm

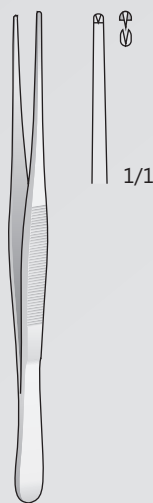

SEMKEN
BD-46
130 mm

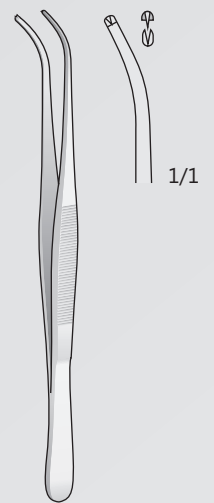

SEMKEN
BD-47
130 mm

Chirurgische pinzetten
Tissue forceps
Pinzette chirurgiche
Pinzas quirúrgicas
Pincas quirúrgicas

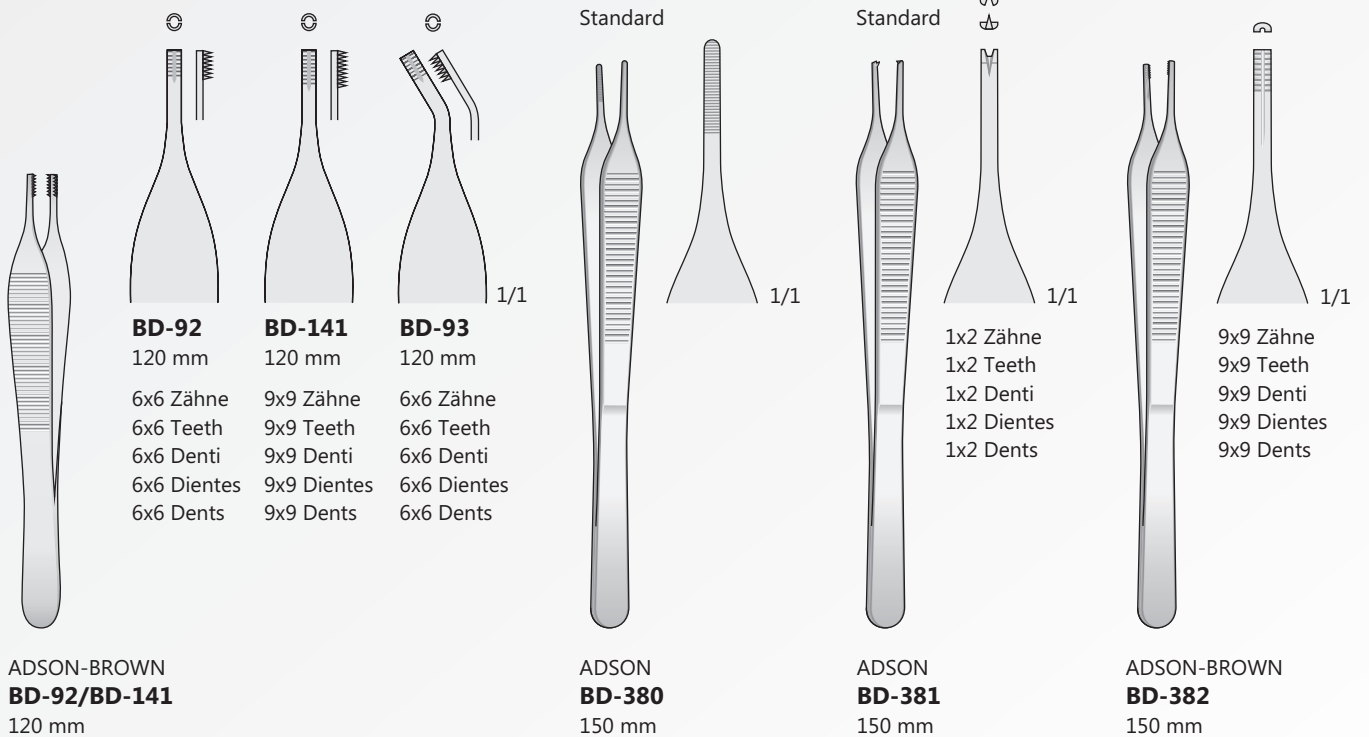
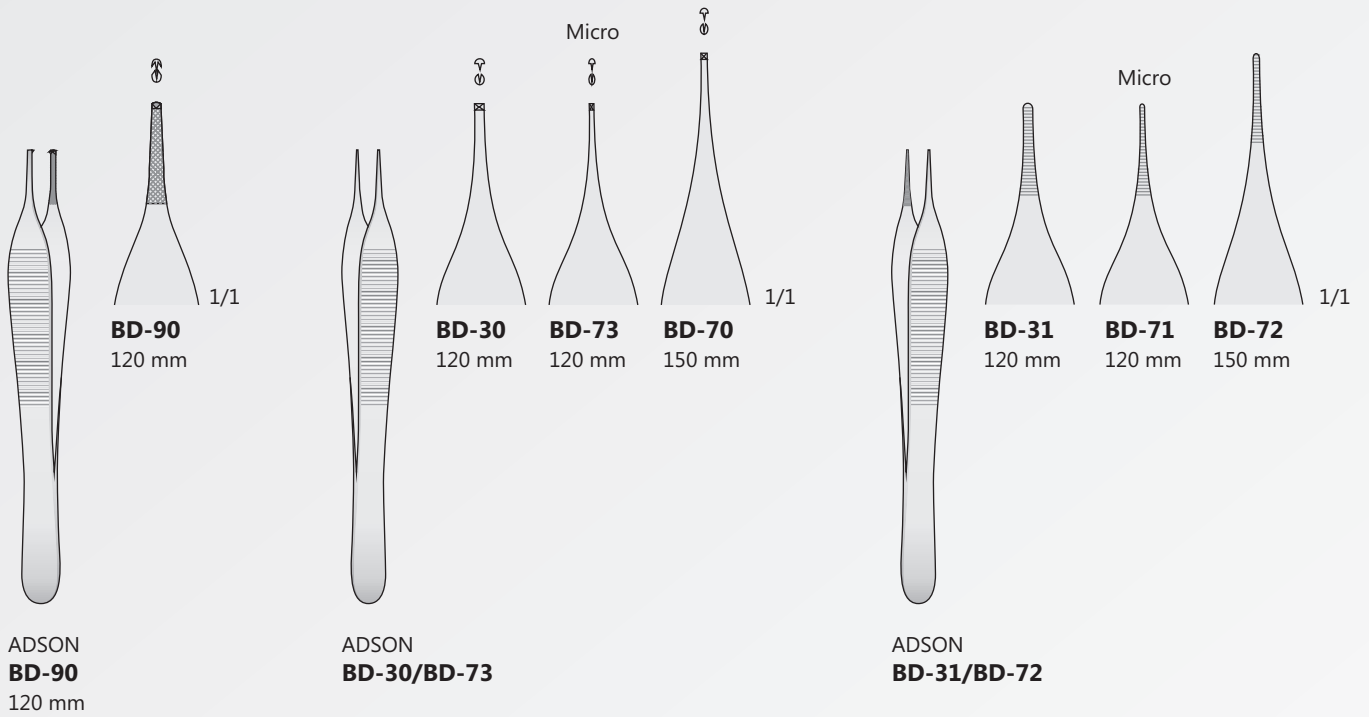

Anatomische Pinzetten
Dressing forceps
Pinzette anatomiche
Pinzas de diseccion
Pincas anatomicas

Standard

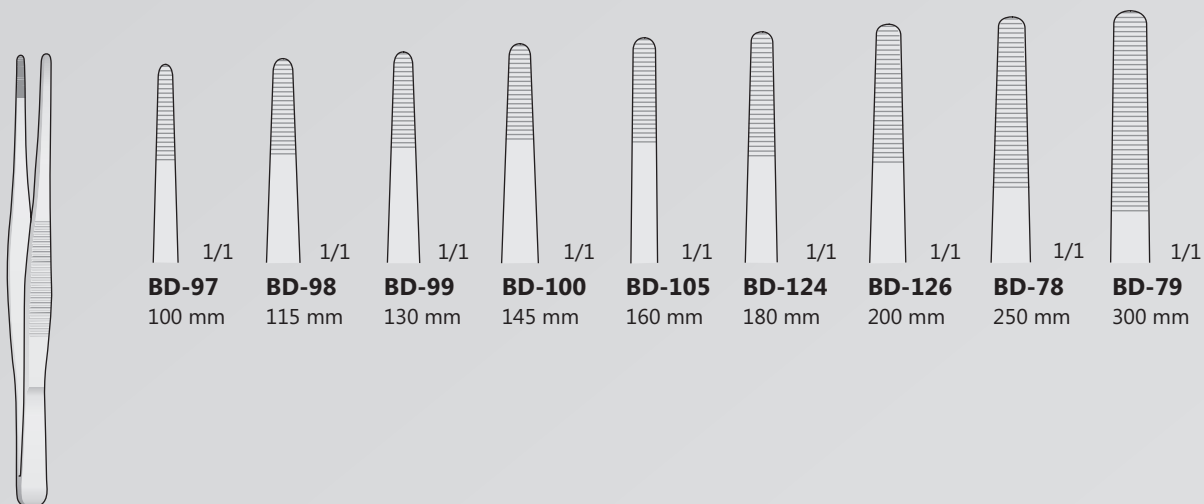

BD-78/BD-126

Mod. Fine

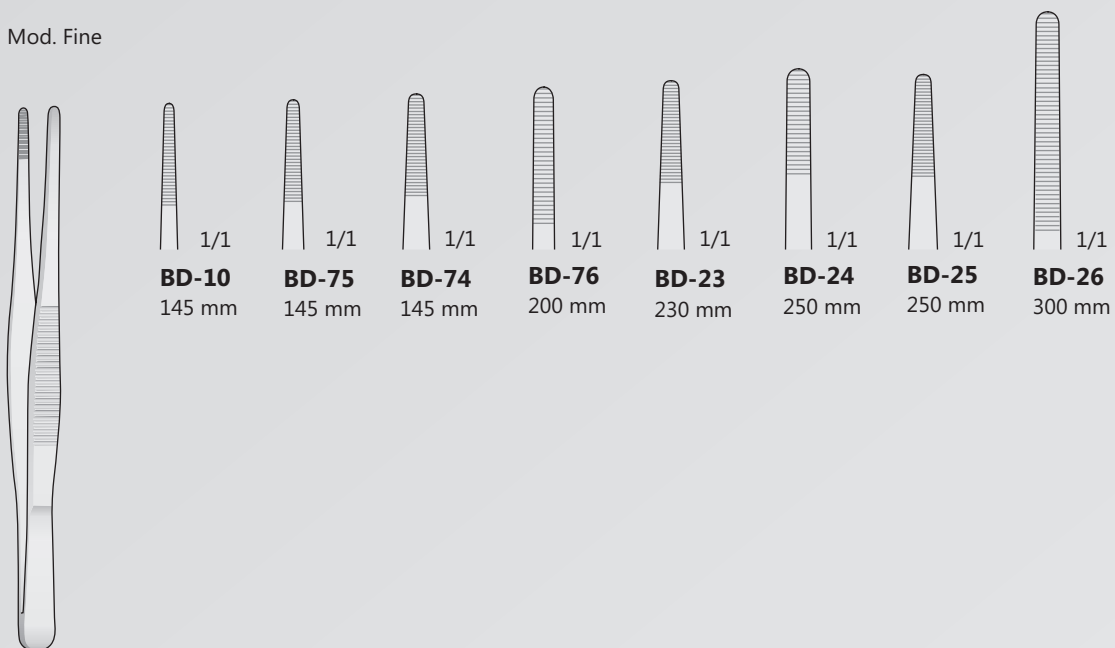

BD-10/BD-76

Anatomische Pinzetten
Dressing forceps
Pinzette anatomiche
Pinzas de diseccion
Pincas anatomiques

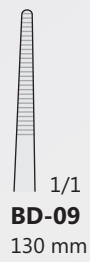

BD-09/BD-20

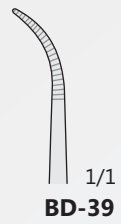

BD-38/BD-134
200 mm

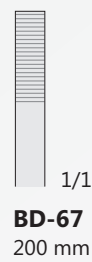
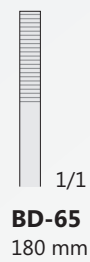
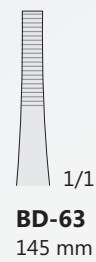
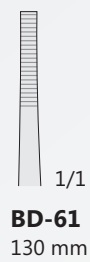

STILLE
BD-61/BD-67

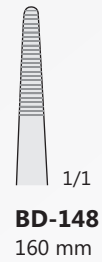
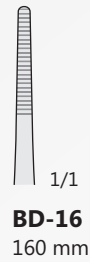

BD-16/BD-148
160 mm

Chirurgische pinzetten
Tissue forceps
Pinzette chirurgiche
Pinzas quirúrgicas
Pincas quirurgicales

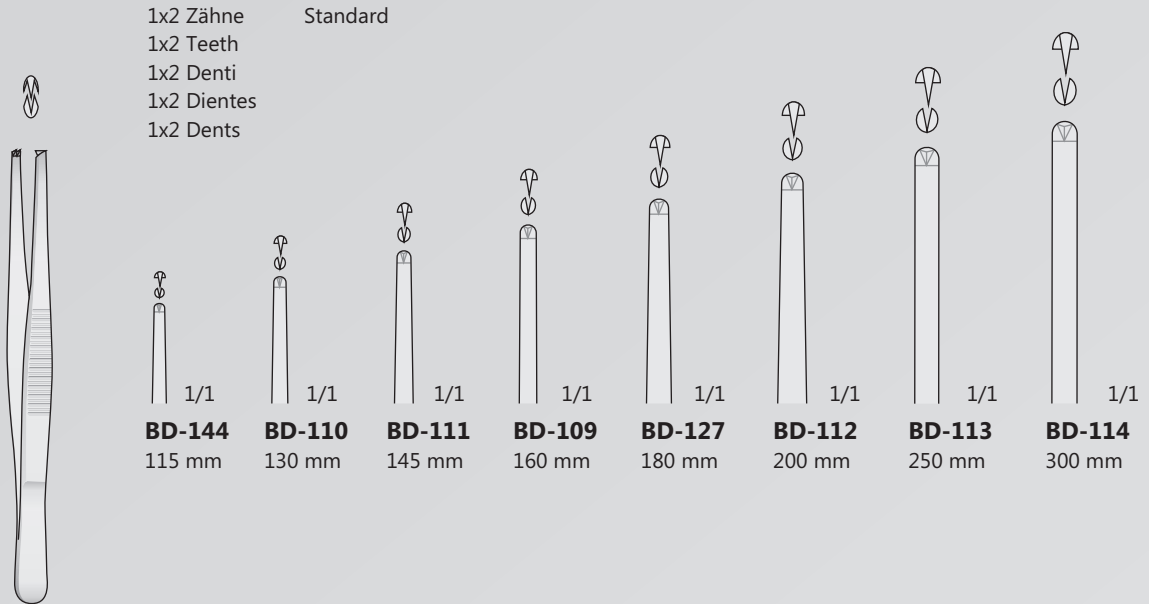

BD-109/BD-144

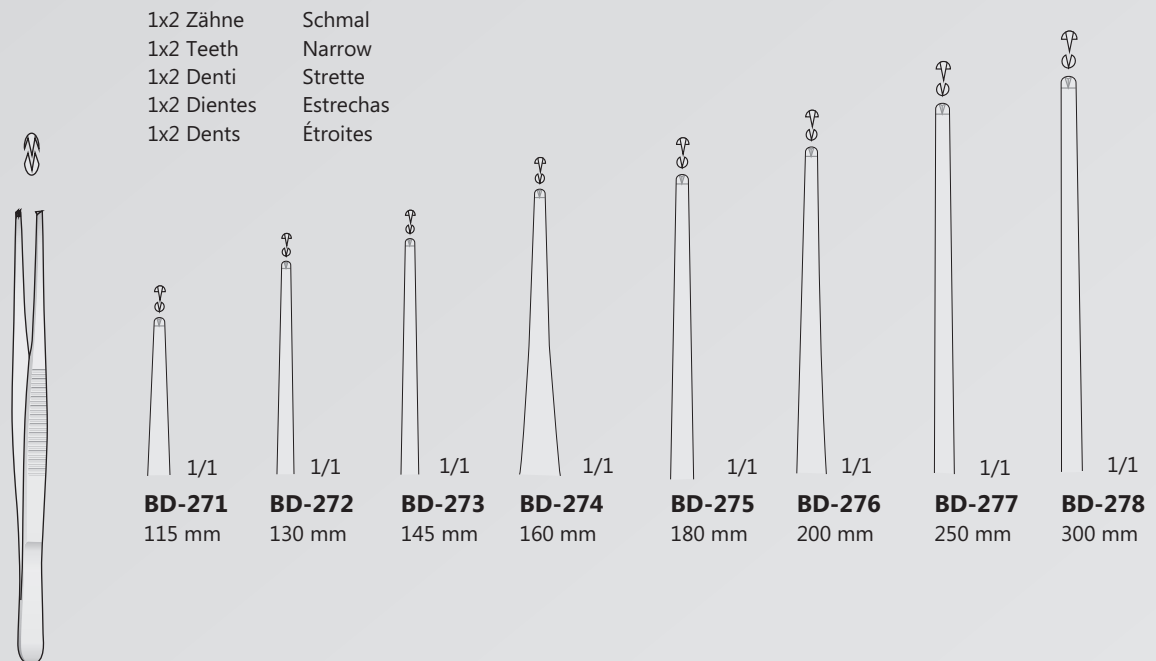

BD-271/BD-278

Chirurgische pinzetten
Tissue forceps
Pinzette chirurgische
Pinzas quirúrgicas
Pincas quirúrgicas

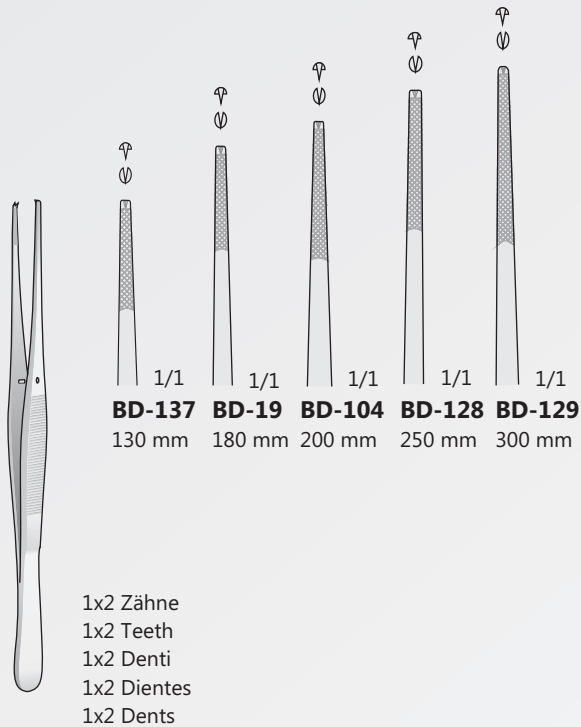

BD-19/BD-137

| | | | | |
|---------------|--------------|---------------|---------------|---------------|
| 1/1 | 1/1 | 1/1 | 1/1 | 1/1 |
| BD-137 | BD-19 | BD-104 | BD-128 | BD-129 |
| 130 mm | 180 mm | 200 mm | 250 mm | 300 mm |

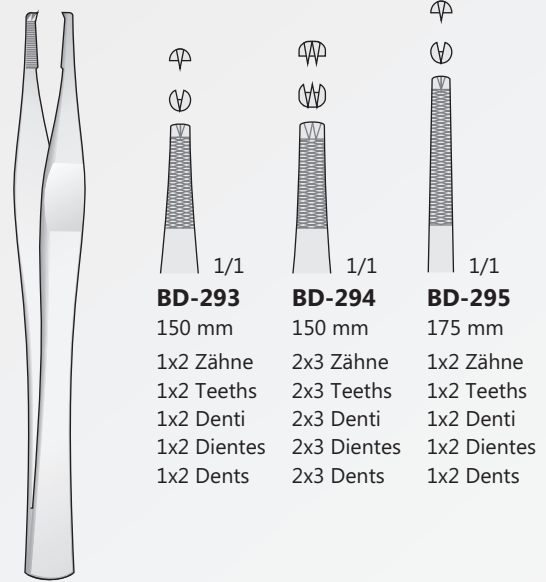

LANE
BD-293/BD-295

| | | |
|---------------|---------------|---------------|
| 1/1 | 1/1 | 1/1 |
| BD-293 | BD-294 | BD-295 |
| 150 mm | 150 mm | 175 mm |
| 1x2 Zähne | 2x3 Zähne | 1x2 Zähne |
| 1x2 Teeths | 2x3 Teeths | 1x2 Teeths |
| 1x2 Denti | 2x3 Denti | 1x2 Denti |
| 1x2 Dientes | 2x3 Dientes | 1x2 Dientes |
| 1x2 Dents | 2x3 Dents | 1x2 Dents |

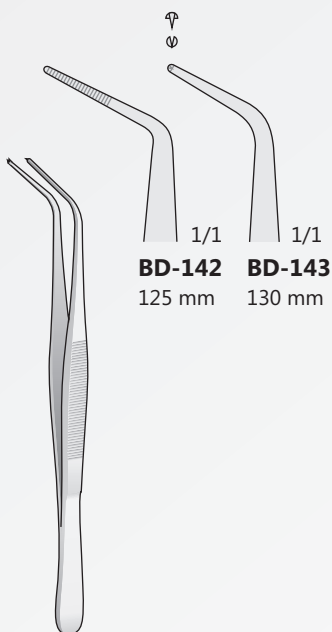

BD-142/BD-143

| | |
|---------------|---------------|
| 1/1 | 1/1 |
| BD-142 | BD-143 |
| 125 mm | 130 mm |

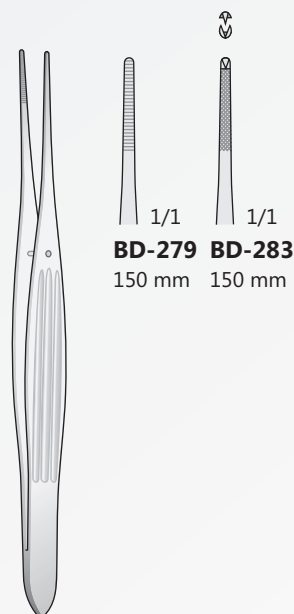

McINDOE
BD-279/BD-283
150 mm

| | |
|---------------|---------------|
| 1/1 | 1/1 |
| BD-279 | BD-283 |
| 150 mm | 150 mm |

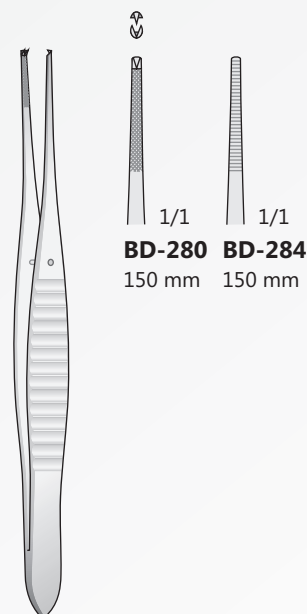

GILLIES
BD-280/BD-284
150 mm

| | |
|---------------|---------------|
| 1/1 | 1/1 |
| BD-280 | BD-284 |
| 150 mm | 150 mm |

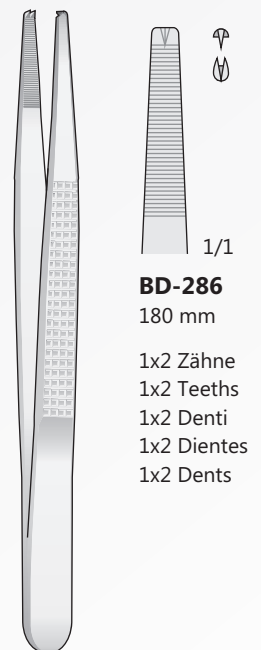

BONNEY
BD-286
180 mm

| |
|---------------|
| 1/1 |
| BD-286 |
| 180 mm |
| 1x2 Zähne |
| 1x2 Teeths |
| 1x2 Denti |
| 1x2 Dientes |
| 1x2 Dents |

Chirurgische pinzette
Tissue forceps
Pinzette chirurgiche
Pinzas quirùrgicas
Pincas quirurgicales

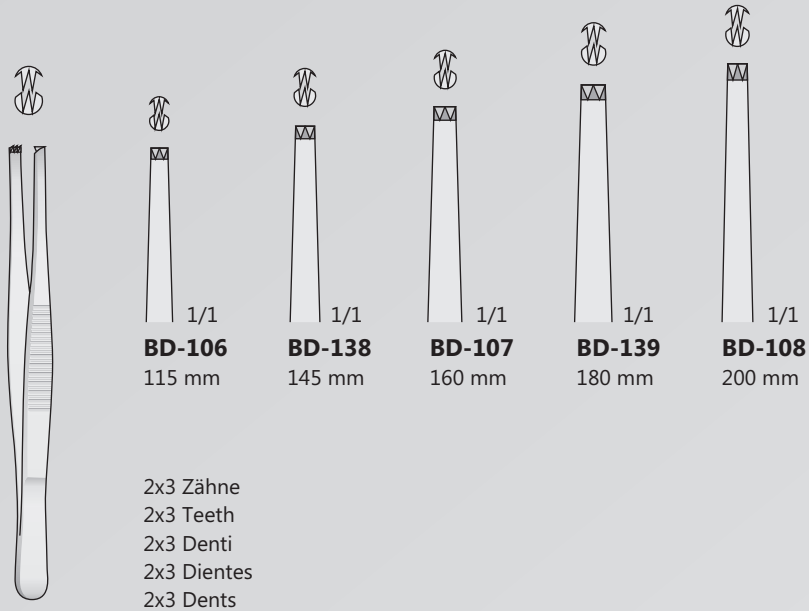

BD-106/BD-139

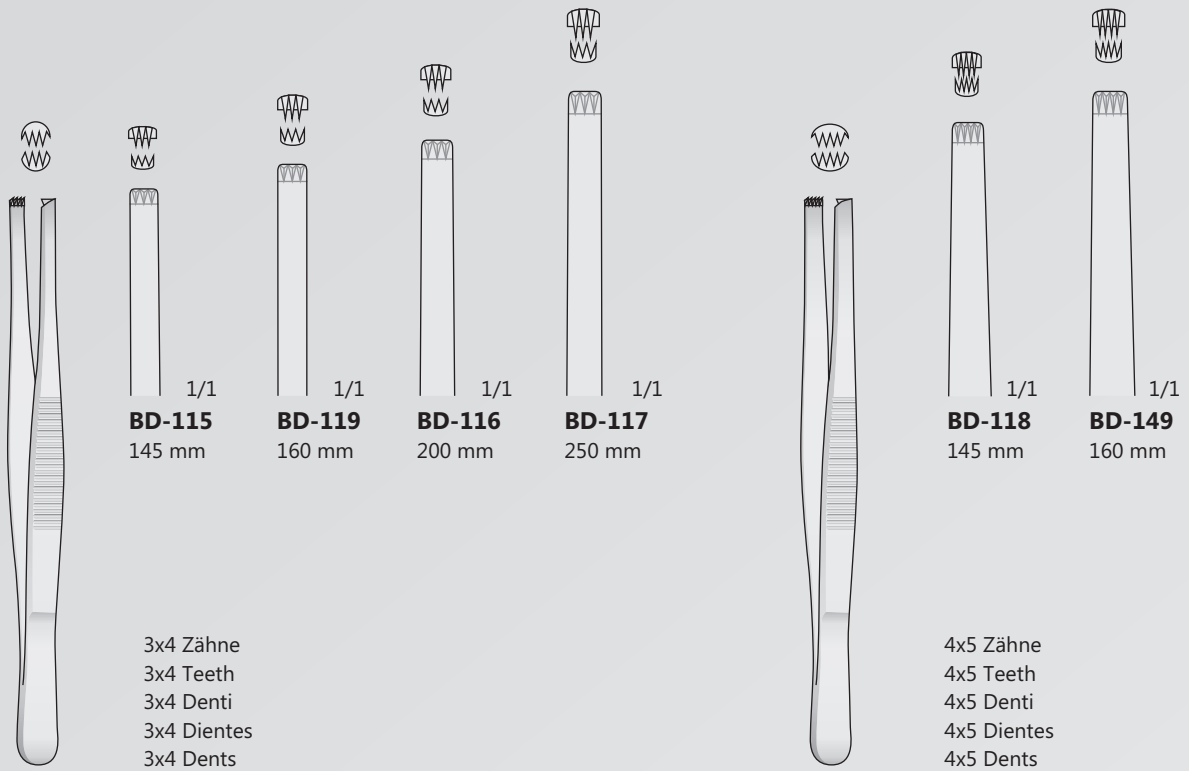

BD-115/BD-119

BD-118/BD-149

Gefäß und Tumorzangen
Vascular and tumor forceps
Pinzette per vasi e per tumori
Pinzas para vasos y tumores
Pinces vaisseaux et tumeurs

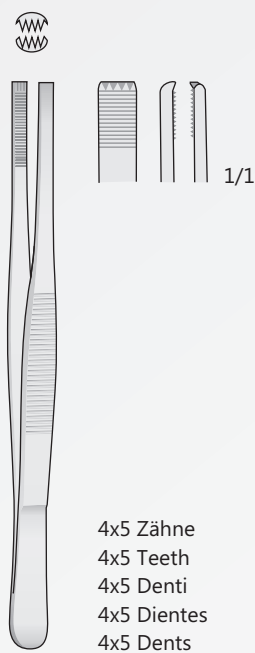

4x5 Zähne
4x5 Teeth
4x5 Denti
4x5 Dientes
4x5 Dents

ADLERKREUTZ
BD-28 - 150 mm
BD-155 - 200 mm
BD-156 - 250 mm

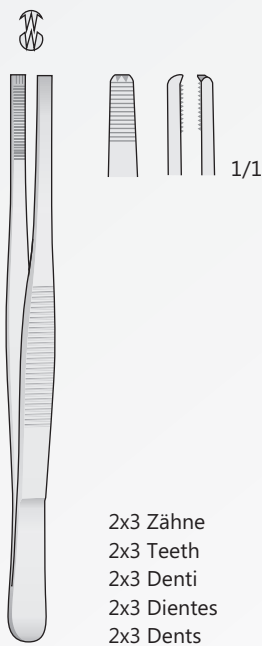

2x3 Zähne
2x3 Teeth
2x3 Denti
2x3 Dientes
2x3 Dents

ADLERKREUTZ
BD-153 - 150 mm
BD-154 - 200 mm

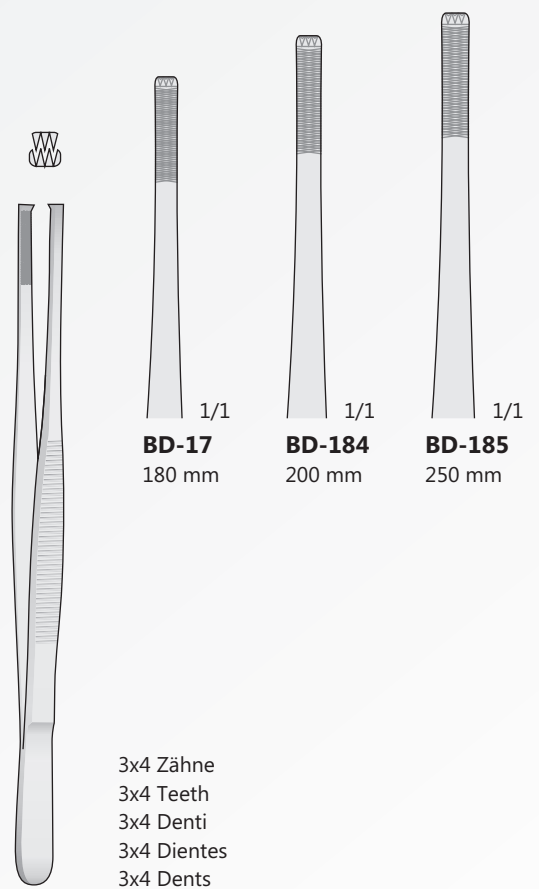

3x4 Zähne
3x4 Teeth
3x4 Denti
3x4 Dientes
3x4 Dents

STILLE-BARRAYA
BD-17/BD-185

Anatomische Pinzetten
Dressing forceps
Pinzette anatomiche
Pinzas de diseccion
Pincas anatomiques

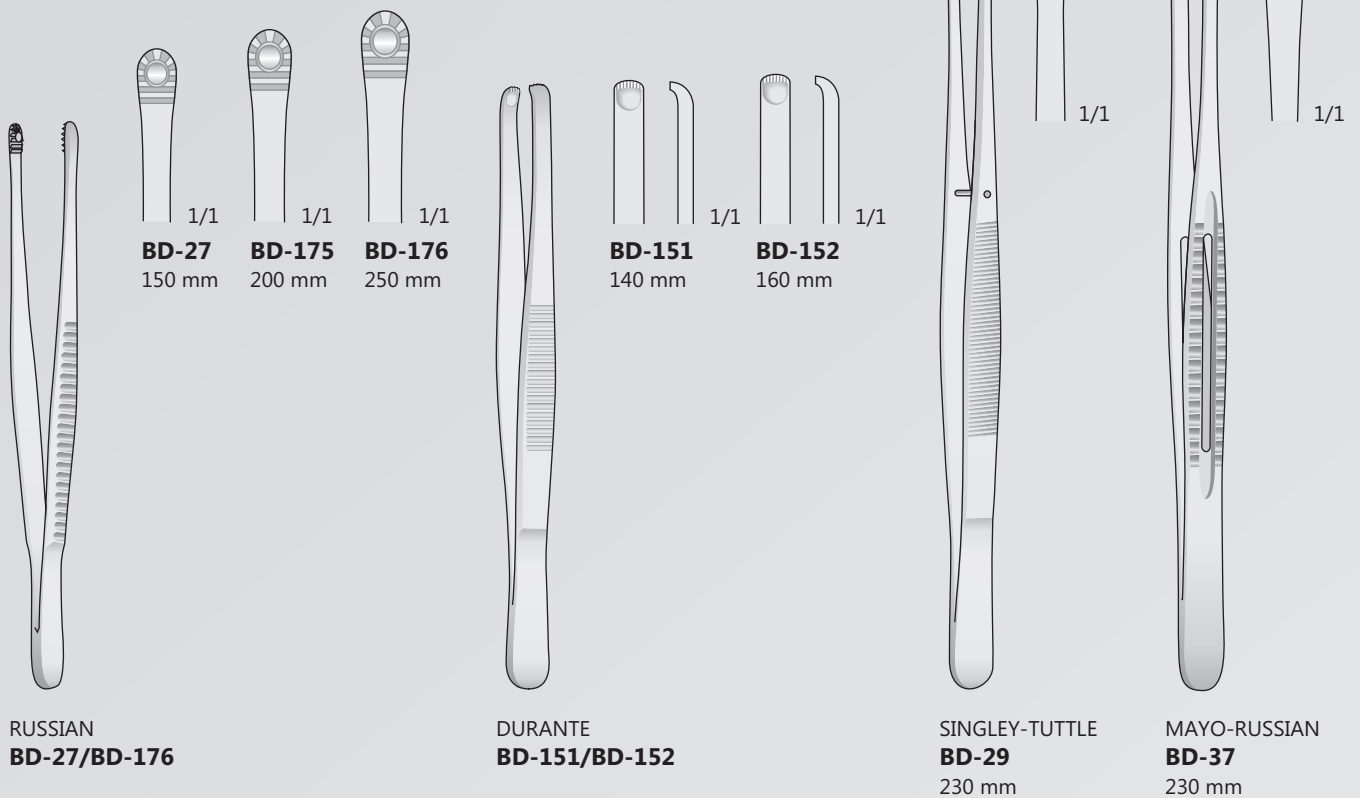

Chirurgische pinzetten
Tissue forceps
Pinzette chirurgiche
Pinzas chirùrgicas
Pincas quirurgicas

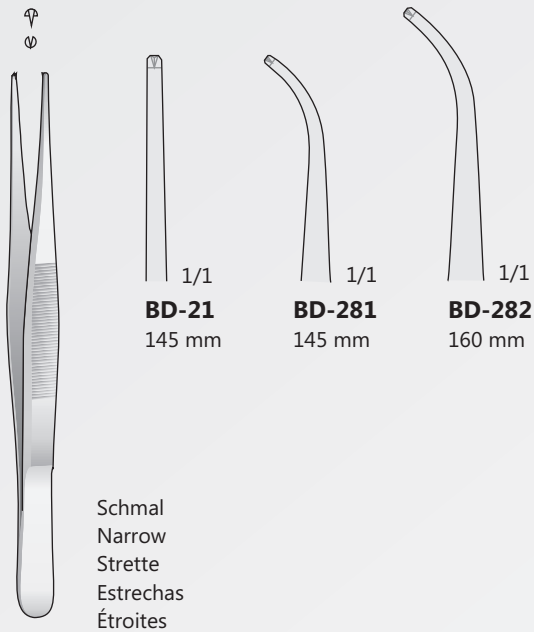

Schmal
Narrow
Strette
Estrechas
Étroites

BD-21/BD-282

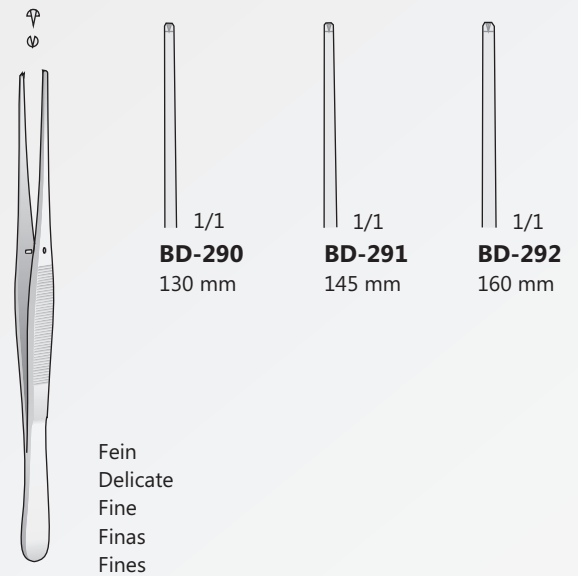

Fein
Delicate
Fine
Finas
Fines

BD-290/BD-292

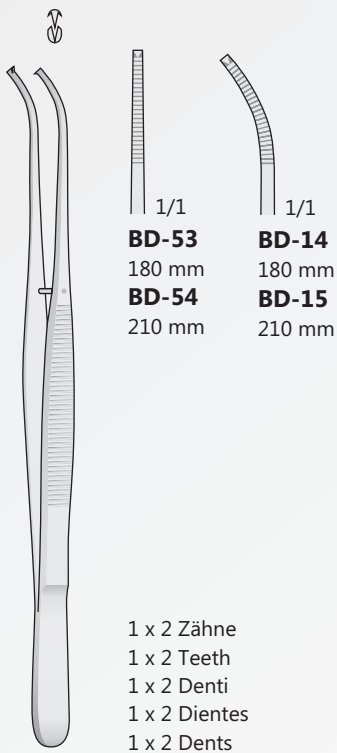

1 x 2 Zähne
1 x 2 Teeth
1 x 2 Denti
1 x 2 Dientes
1 x 2 Dents

POTTS-SMITH
BD-14/BD-54

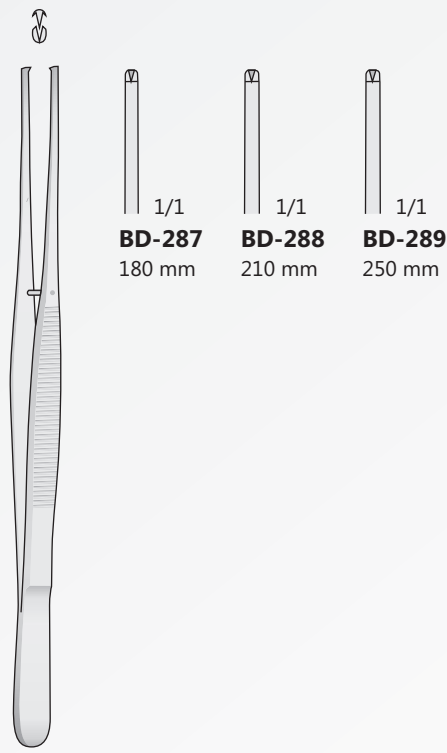

POTTS-SMITH
BD-287/BD-289

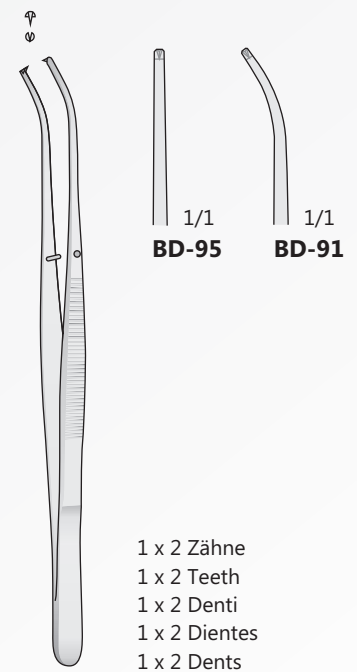

1 x 2 Zähne
1 x 2 Teeth
1 x 2 Denti
1 x 2 Dientes
1 x 2 Dents

SEMKEN
BD-91/BD-95
150 mm

Atraumatiche Pinzette
Atraumatic Tissue forceps
Pinzette atraumatiche
Pinzas Atraumaticas
Pinces Atraumatiques

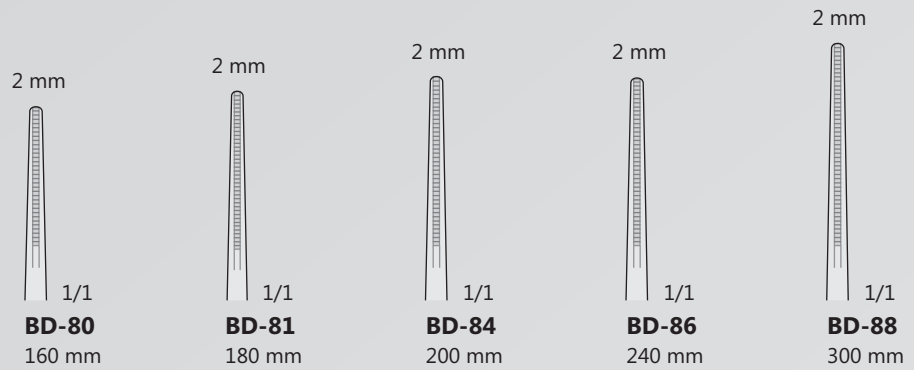
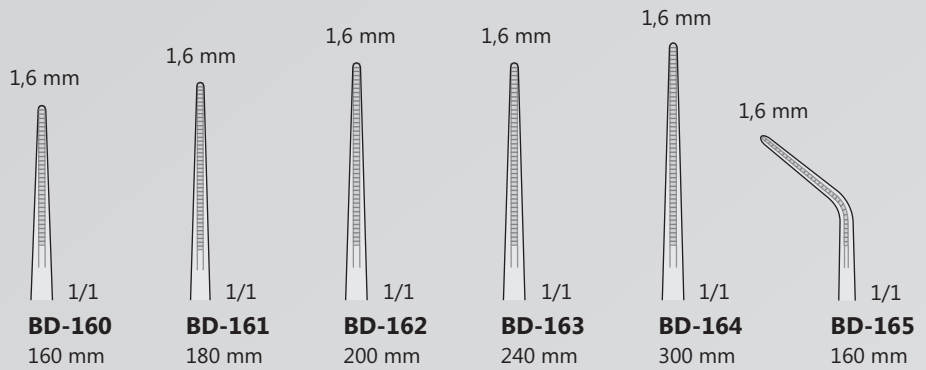

Atraumatiche pinzette
Non-traumatic vascular forceps
Pinzette atraumatiche
Pinzas atraumaticas
Pinces atraumatiques

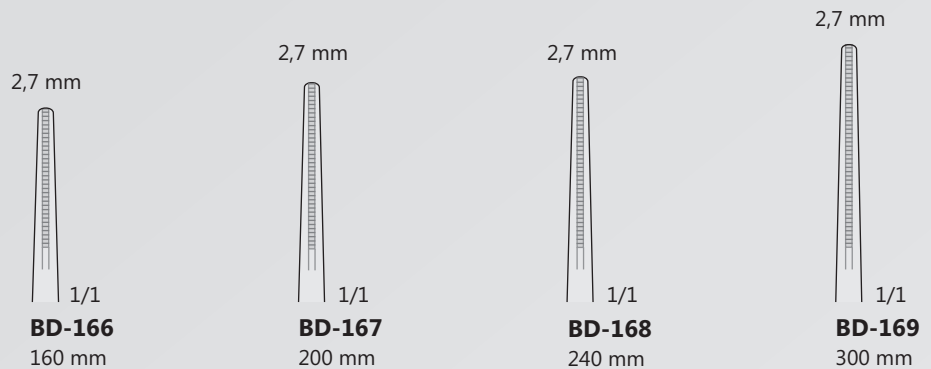
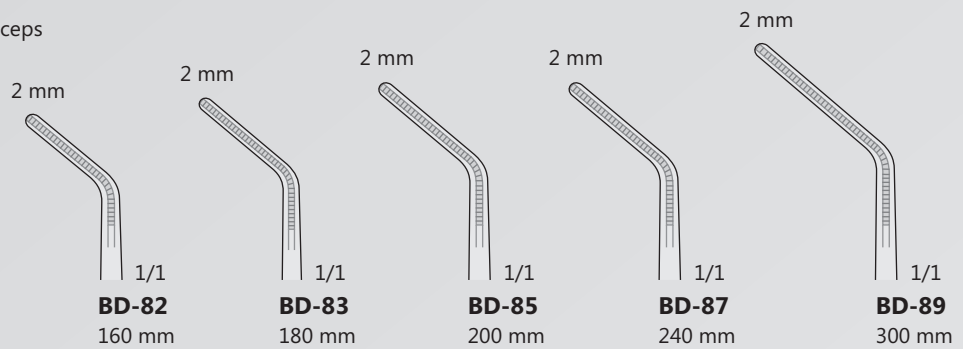

DE BAKEY
BD-80/BD-169

Chirurgische pinzetten
Tissue forceps
Pinzette chirurgiche
Pinzas chirùrgicas
Pincas chirurgicales

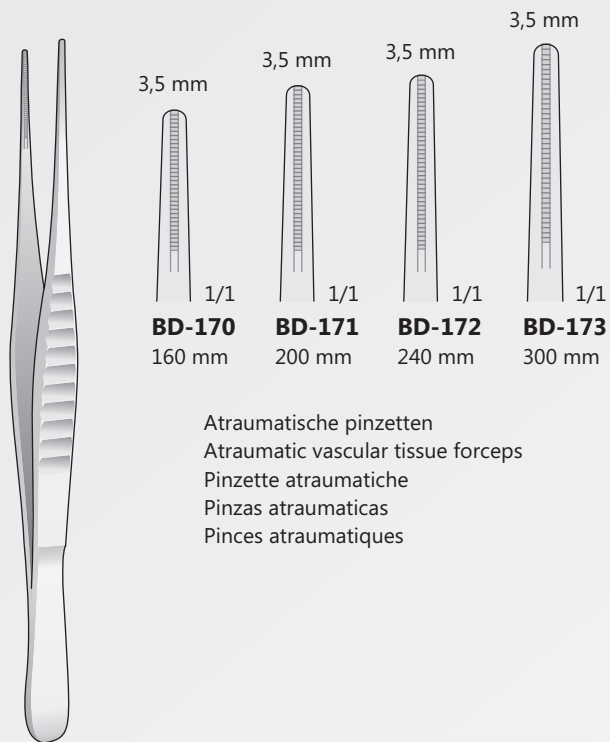

Atraumatische pinzetten
Atraumatic vascular tissue forceps
Pinzette atraumatiche
Pinzas atraumaticas
Pincas atraumatiques

DE BAKEY
BD-170/BD-173

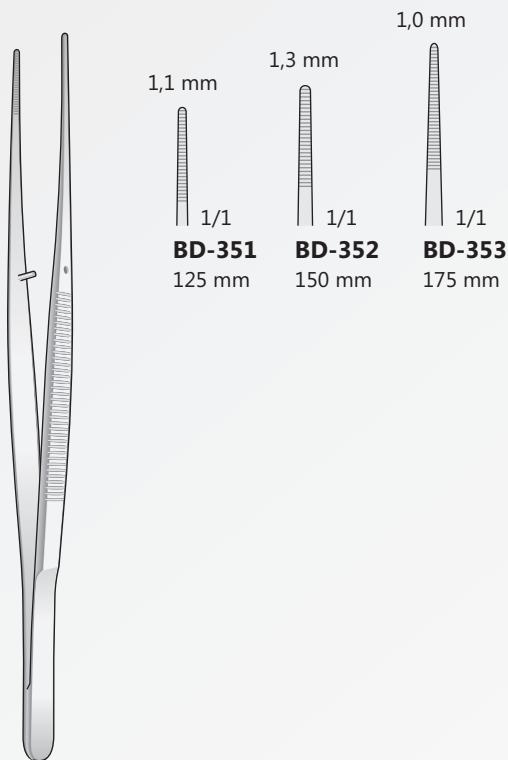

BD-351/BD-353

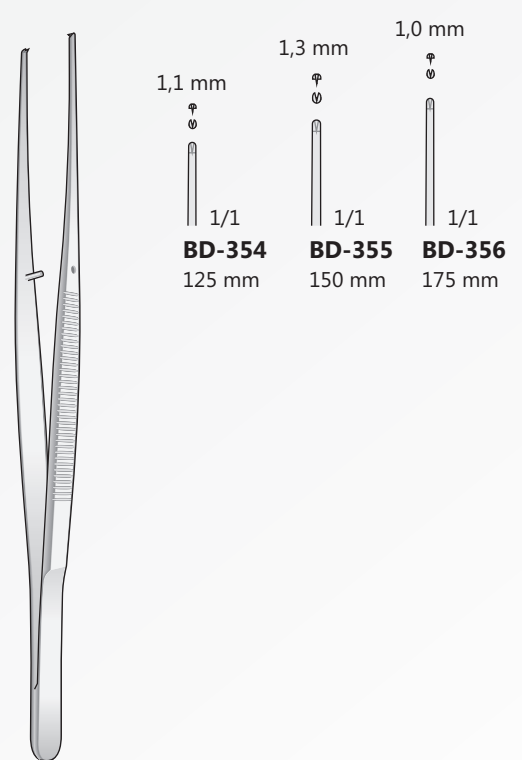

BD-354/BD-355

Chirurgische pinzetten
Tissue forceps
Pinzette chirurgiche
Pinzas quirùrgicas
Pincas quirurgicales

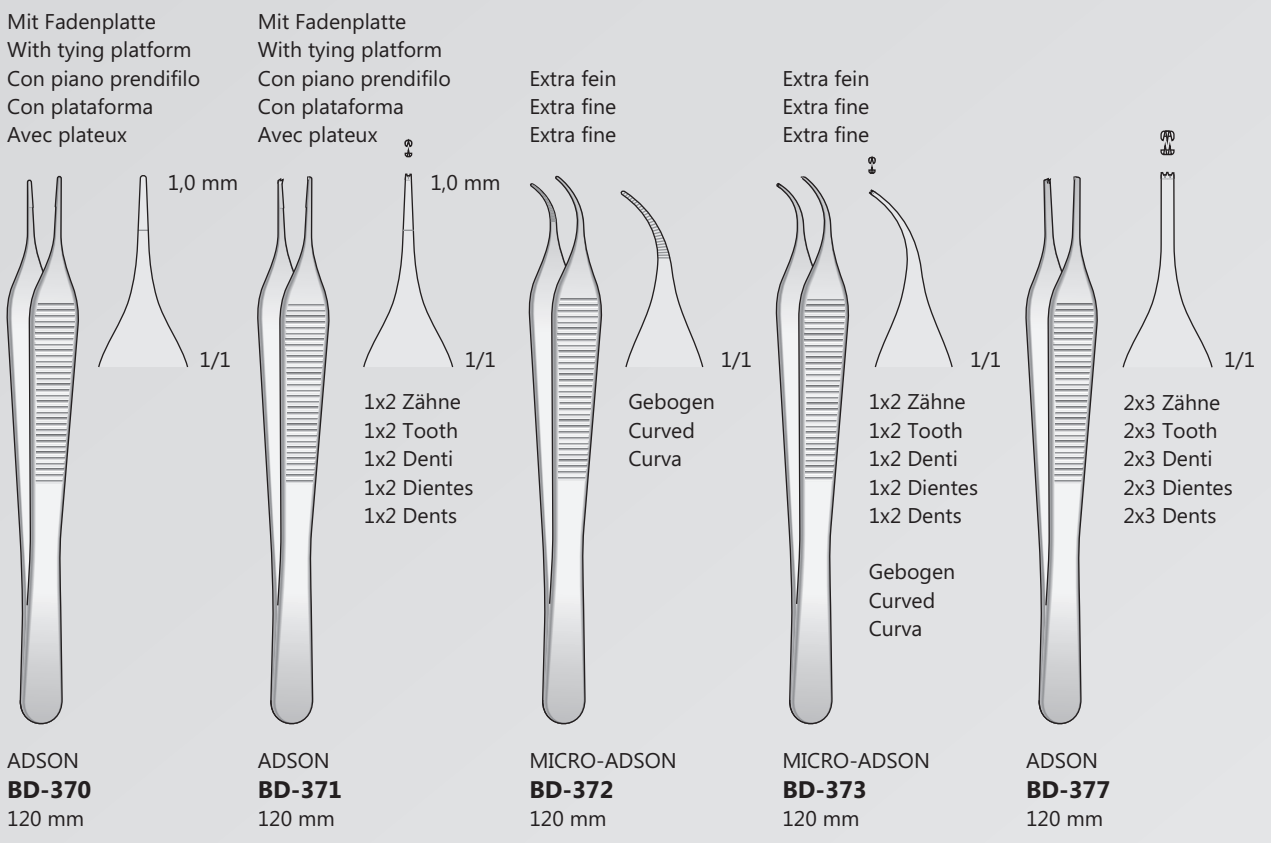
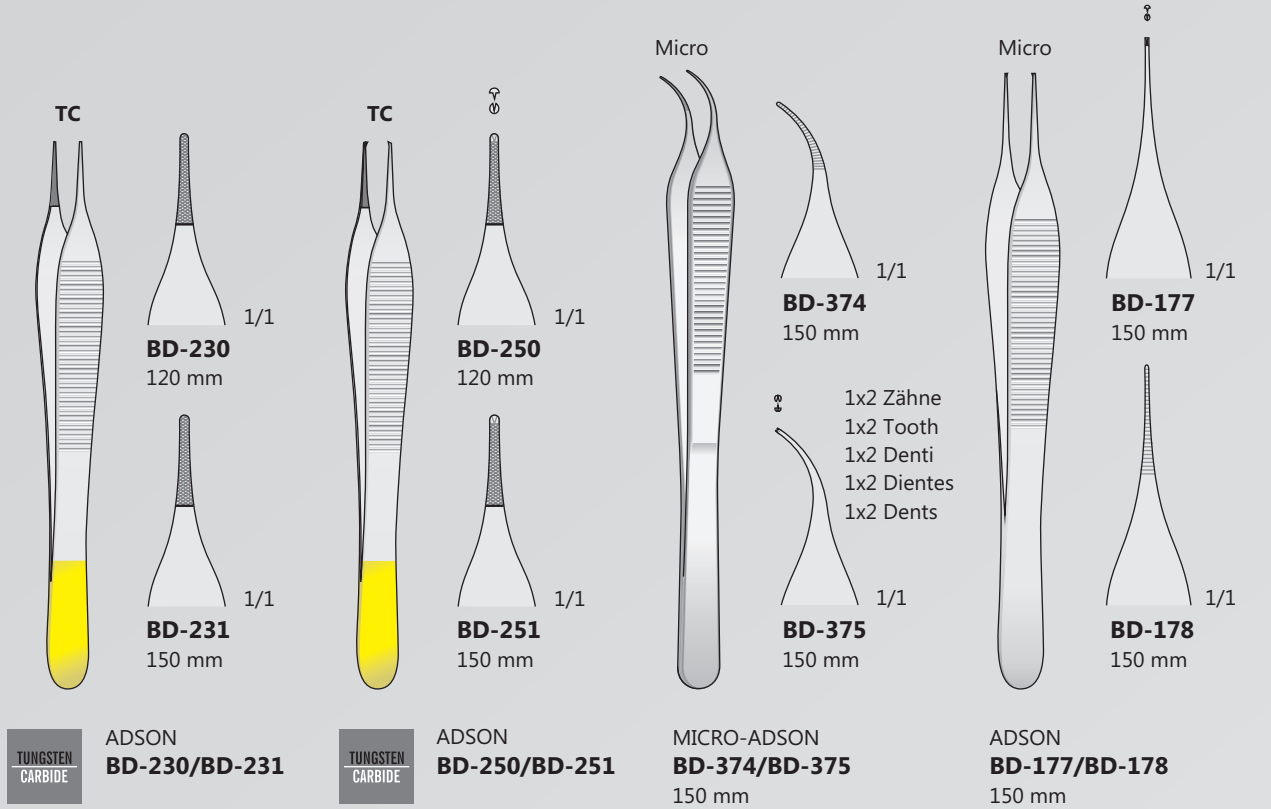

Ohr Pinzetten
Ear forceps
Pinzette auricolari
Pinzas auriculares
Pincas auriculaires

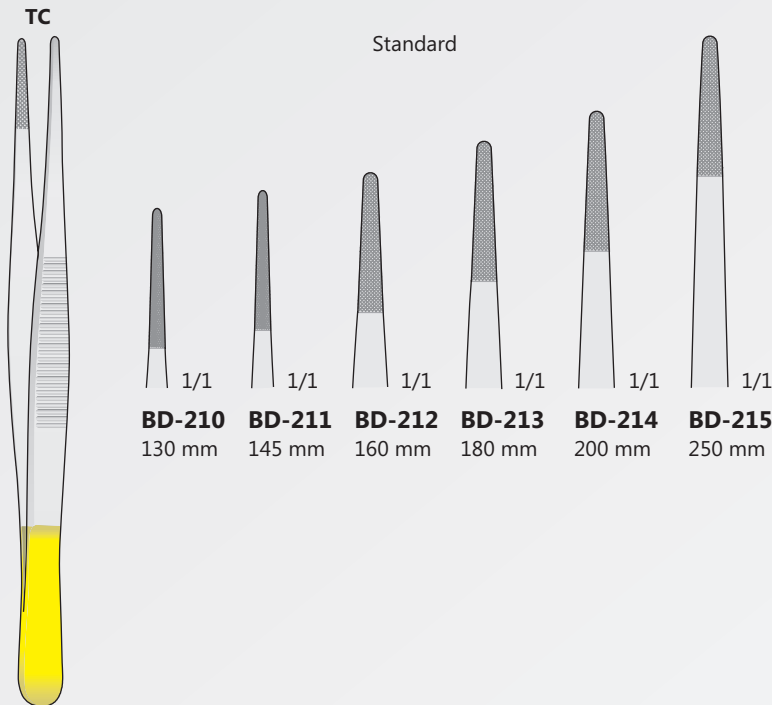

BD-210 130 mm
BD-211 145 mm
BD-212 160 mm
BD-213 180 mm
BD-214 200 mm
BD-215 250 mm

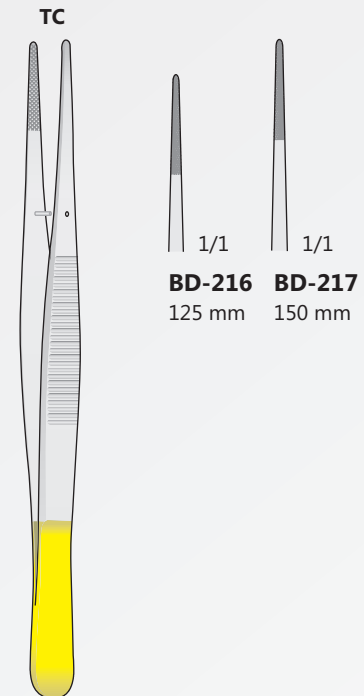

BD-216 125 mm
BD-217 150 mm

TUNGSTEN
CARBIDE

BD-210/BD-215

TUNGSTEN
CARBIDE

SEMKEN
BD-216/BD-217

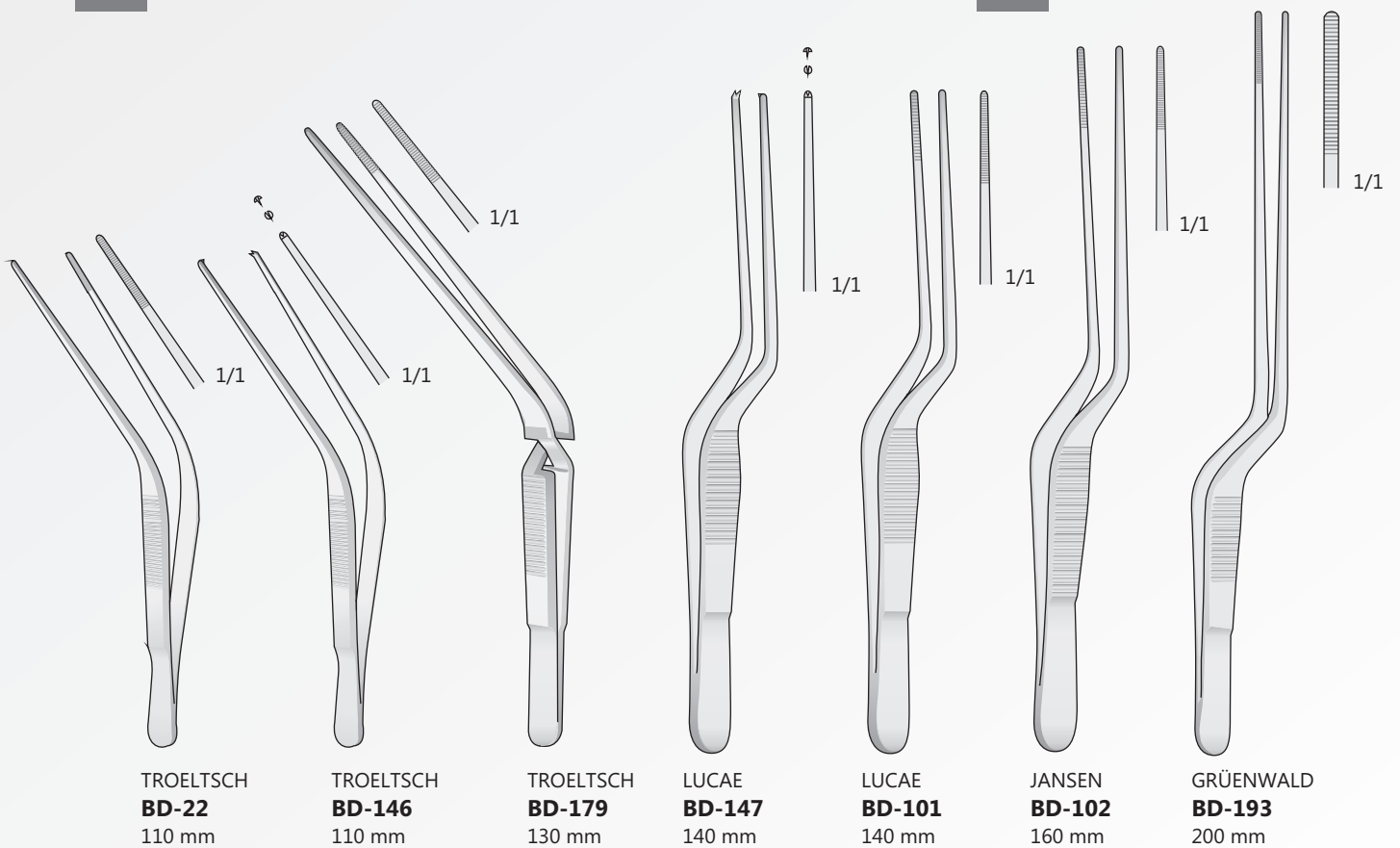

TROELTSCH
BD-22
110 mm

TROELTSCH
BD-146
110 mm

TROELTSCH
BD-179
130 mm

LUCAE
BD-147
140 mm

LUCAE
BD-101
140 mm

JANSEN
BD-102
160 mm

GRÜNWARD
BD-193
200 mm

Bipolarpinzetten
Bipolar Forceps
Pinzette bipolari
Pinzas bipolares
Pince bipolaire

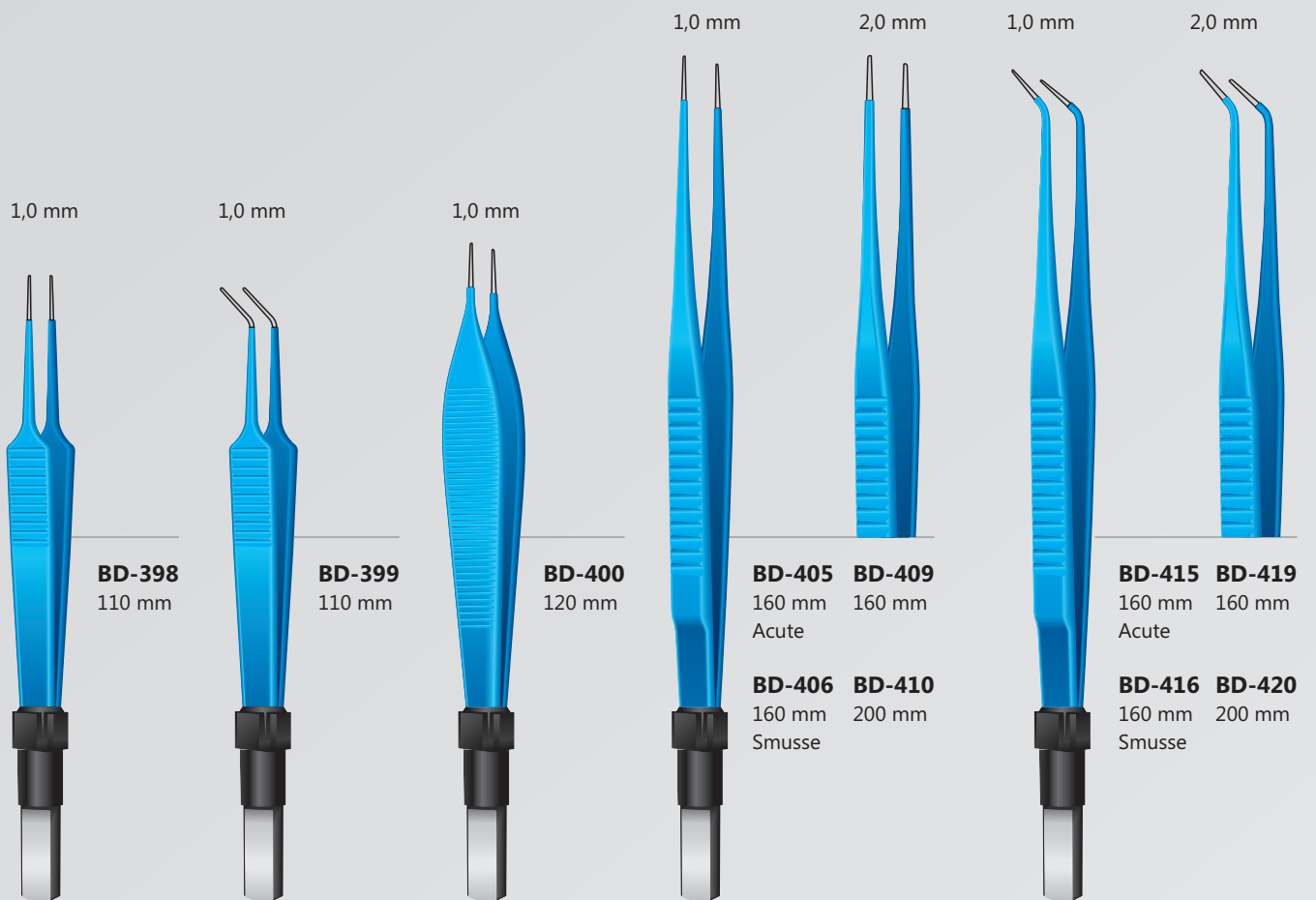



BONTEMPI
CHIRURGISCHE INSTRUMENTE

Tuchklemmen, Arterienklemmen und Bulldogklemmen
Towel Forceps, Hemostatic Forceps and Bulldog Clamps
Fissateli, Pinze emostatiche e Pinze Bulldog
Pinzas para campos, Pinzas hemostáticas y Pinzas Bulldog
Pinces à champs, Pinces hémostatiques et Pinces Bulldog

Arterienklemmen
Hemostatic forceps
Pinze emostatiche
Pinzas hemostáticas
Pincas hémostatiques

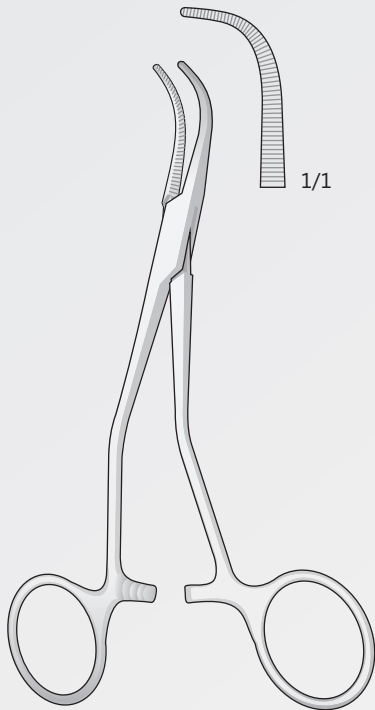

P-15
130 mm

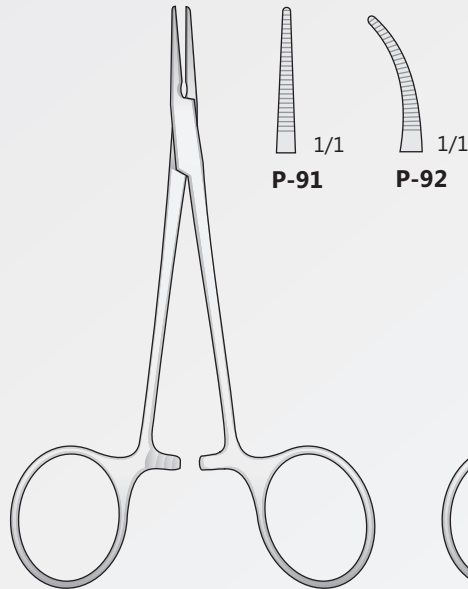

HALSTED
P-91/P-92
125 mm

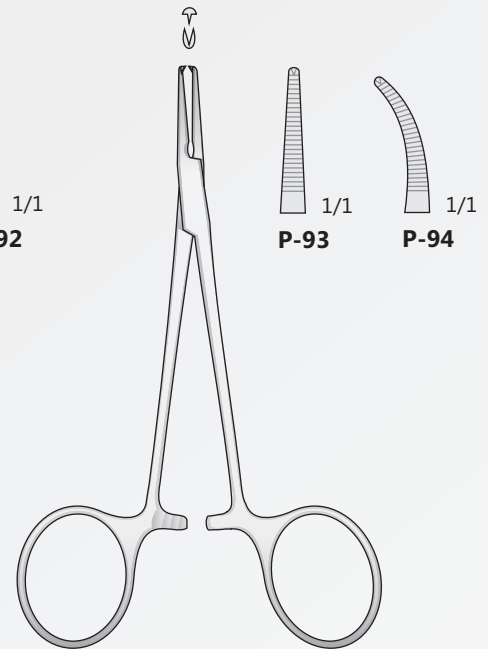

HALSTED
P-93/P-94
125 mm

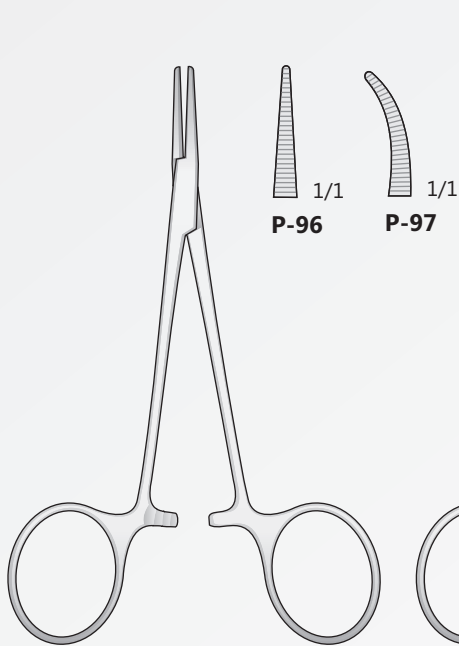

HALSTED-MOSQUITO
P-96/P-97
120 mm

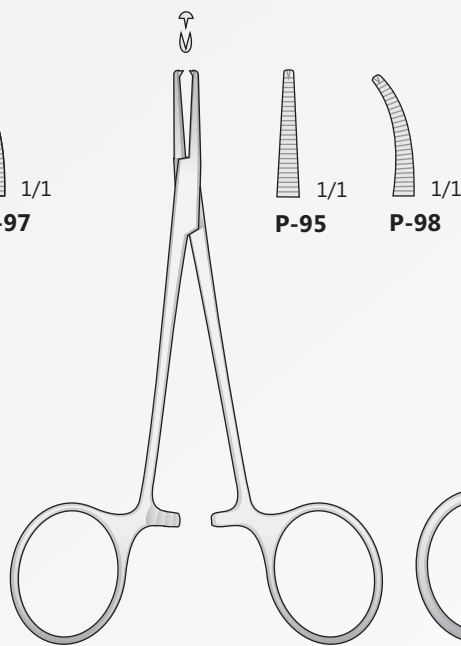

HALSTED-MOSQUITO
P-95/P-98
120 mm

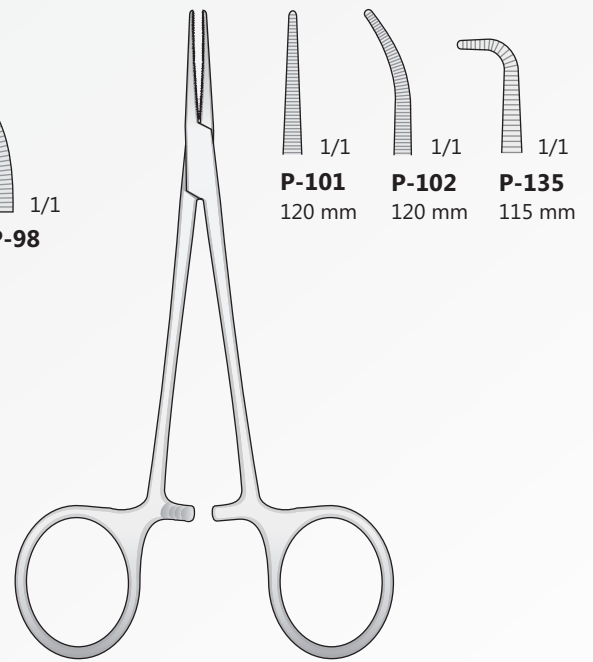

MICRO-HALSTED
P-101/P-135

Arterienklemmen
Hemostatic forceps
Pinze emostatiche
Pinzas hemostáticas
Pincas hémostatiques

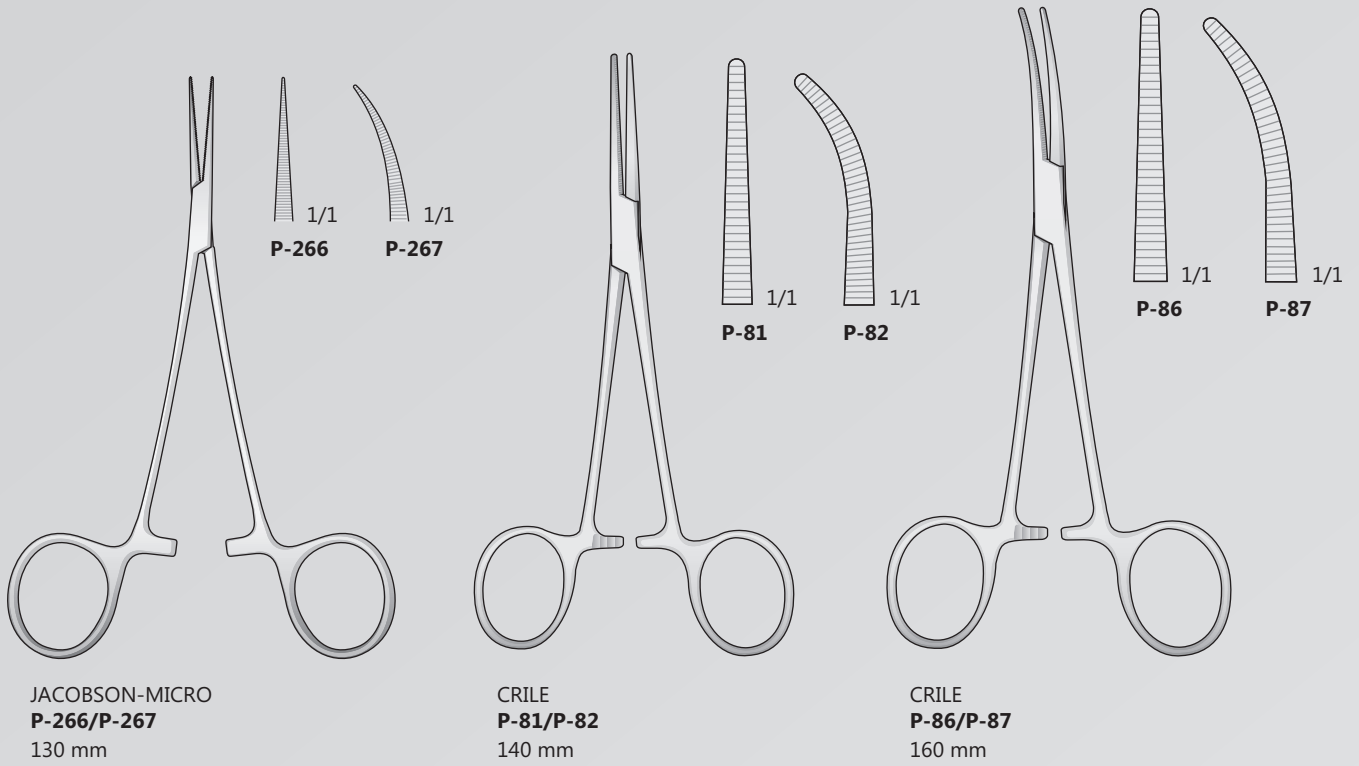

Curve sul lato
Curved to side
Seitwärts gebogen
Courbes latérales
Curvas laterales

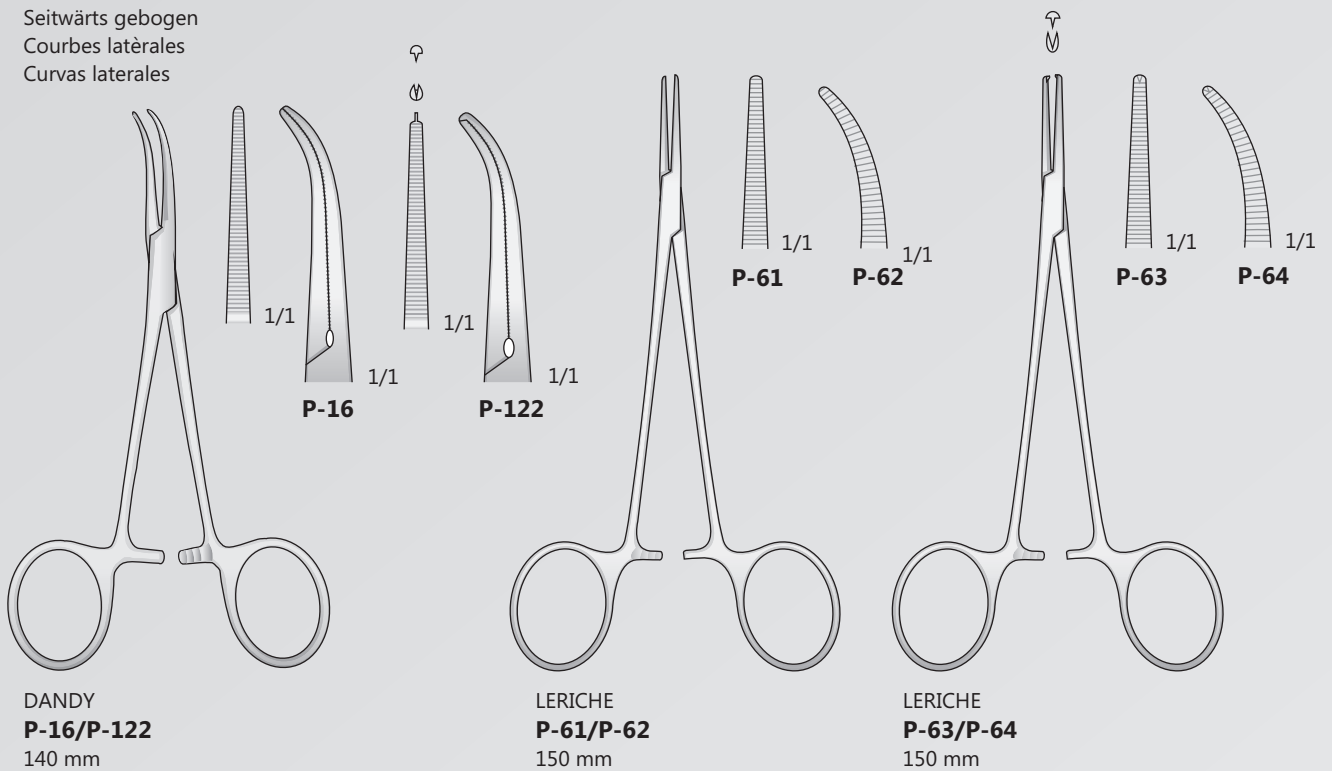

Arterienklemmen
Hemostatic forceps
Pinze emostatiche
Pinzas hemostáticas
Pincas hémostatiques

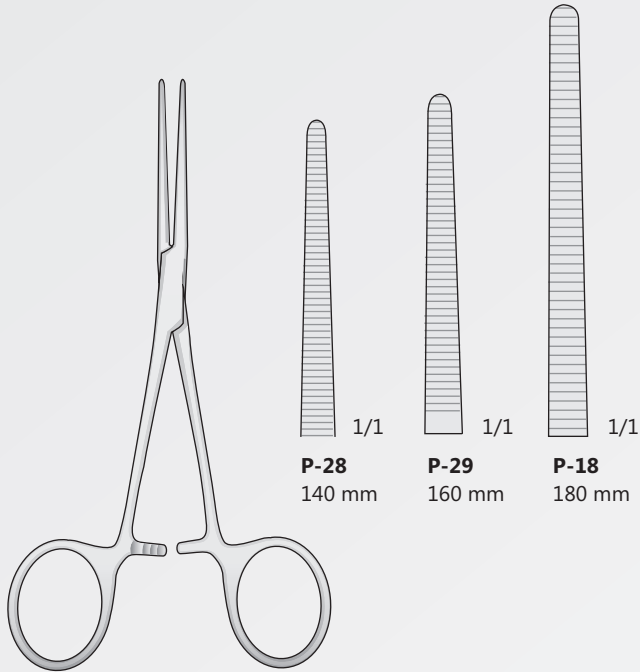

P-28
140 mm

P-29
160 mm

P-18
180 mm

ROCHESTER-PEAN
P-18/P-29

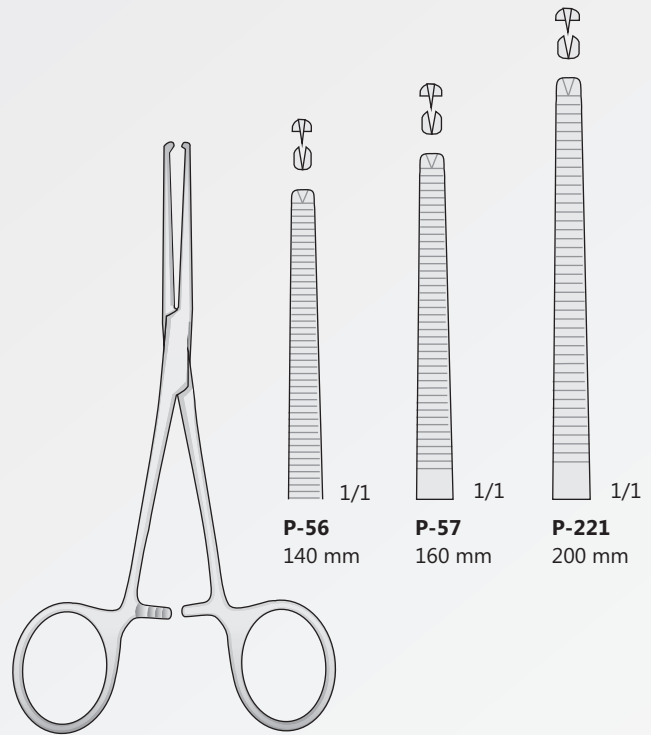

P-56
140 mm

P-57
160 mm

P-221
200 mm

KOCHER-OCHSNER
P-56/P-221

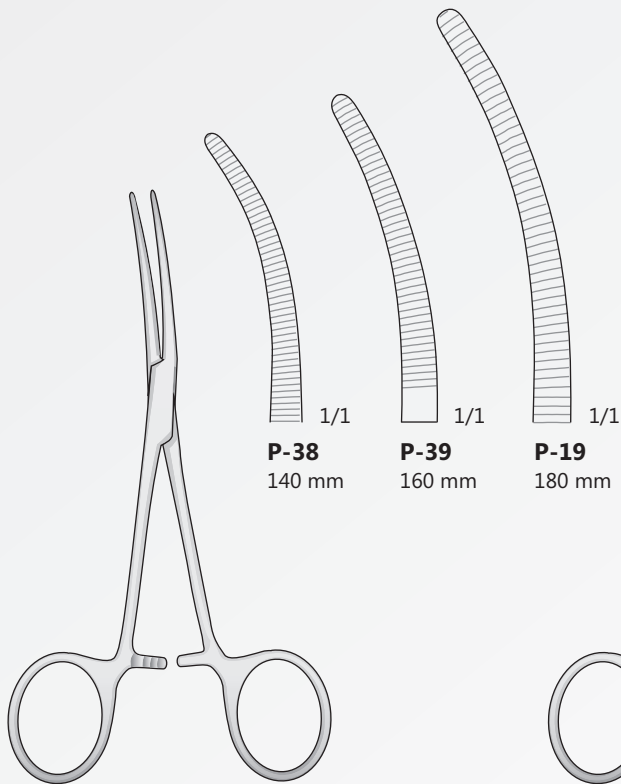

P-38
140 mm

P-39
160 mm

P-19
180 mm

ROCHESTER-PEAN
P-19/P-39

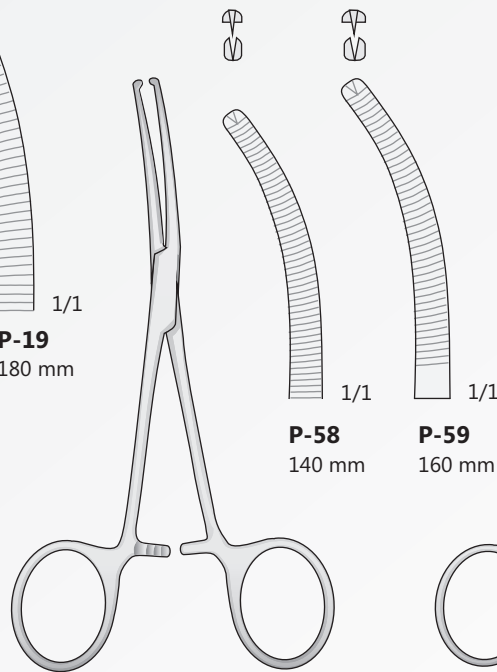

P-58
140 mm

P-59
160 mm

KOCHER-OCHSNER
P-58/P-59

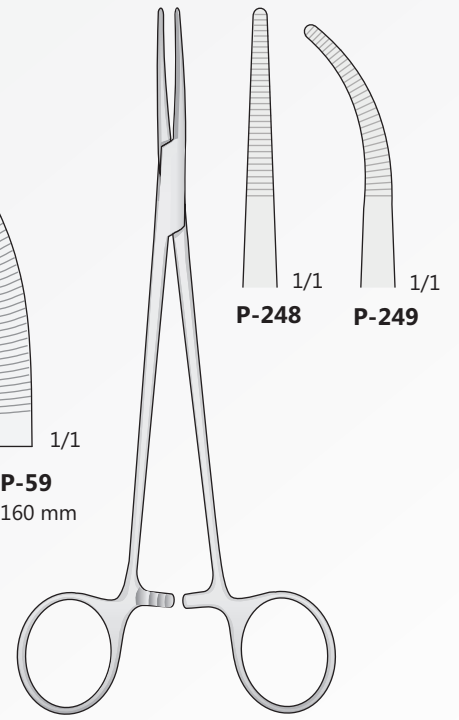

P-248

P-249

BIRKETT
P-248/P-249
180 mm

Arterienklemmen
Hemostatic forceps
Pinze emostatiche
Pinzas hemostáticas
Pincas hémostatiques

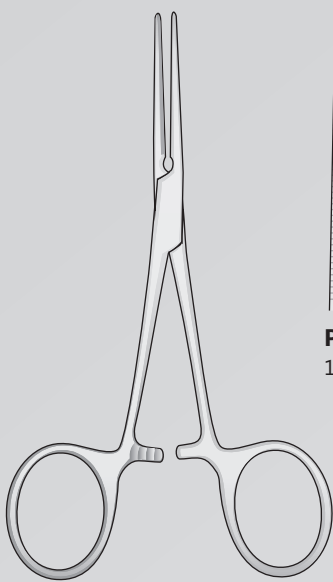

PEAN
P-250/P-255

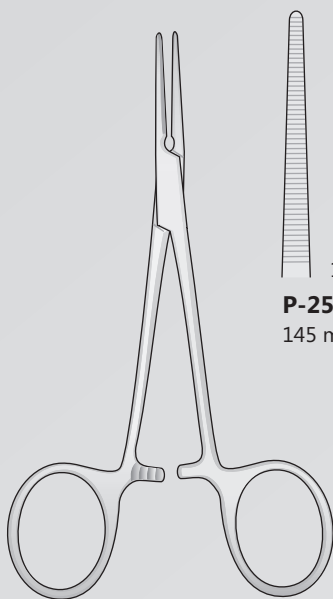
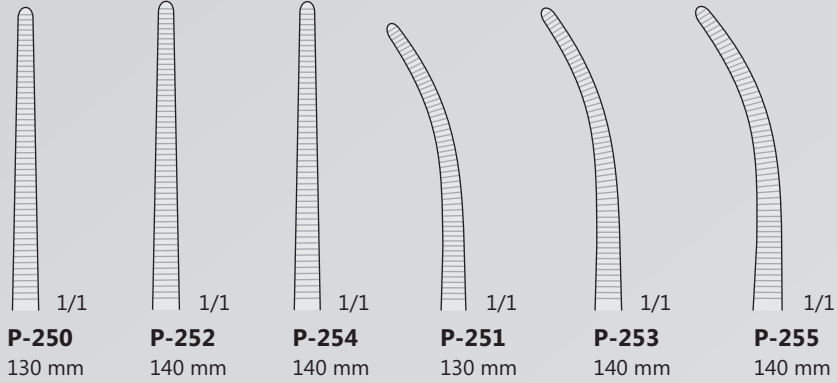

PEAN
P-256/P-259

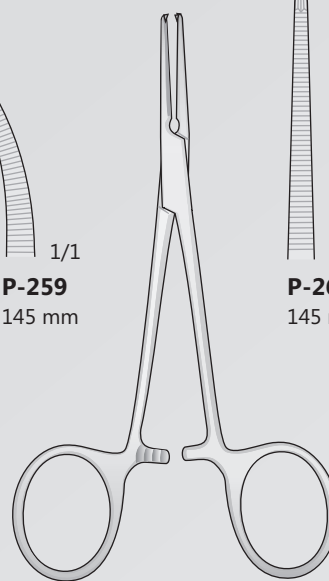
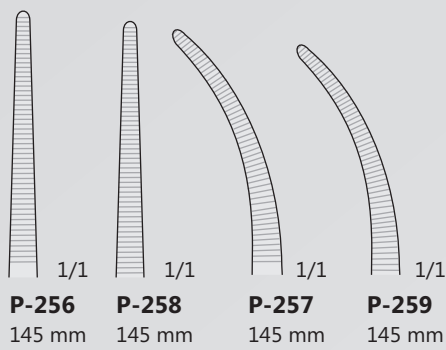

KOCHER
P-260/P-263

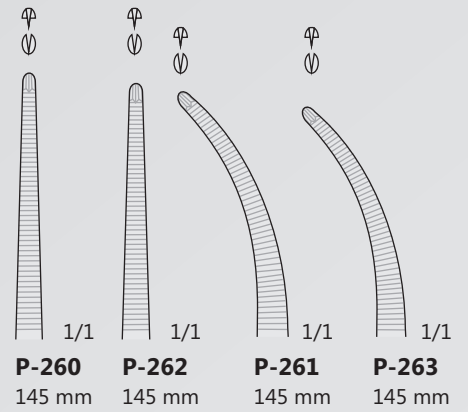

Arterienklemmen
Hemostatic forceps
Pinze emostatiche
Pinzas hemostáticas
Pincès hémostatiques

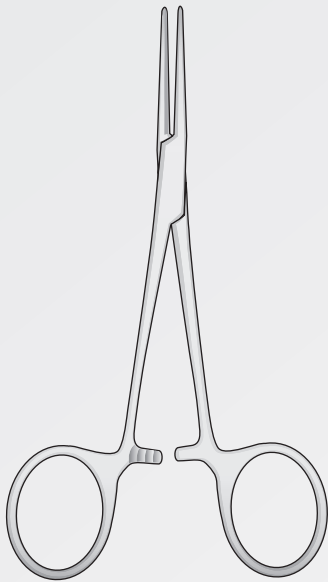

PEAN
P-20/P-27

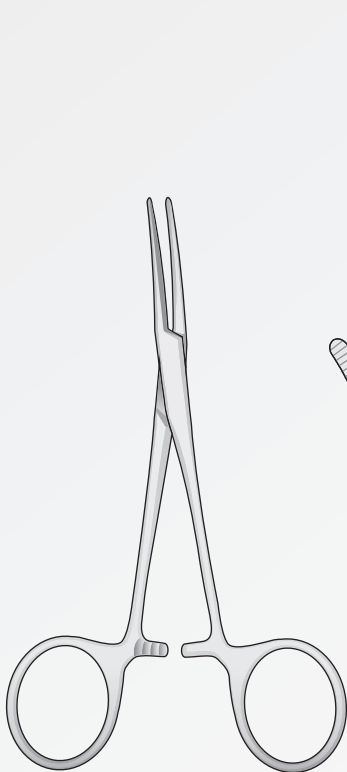
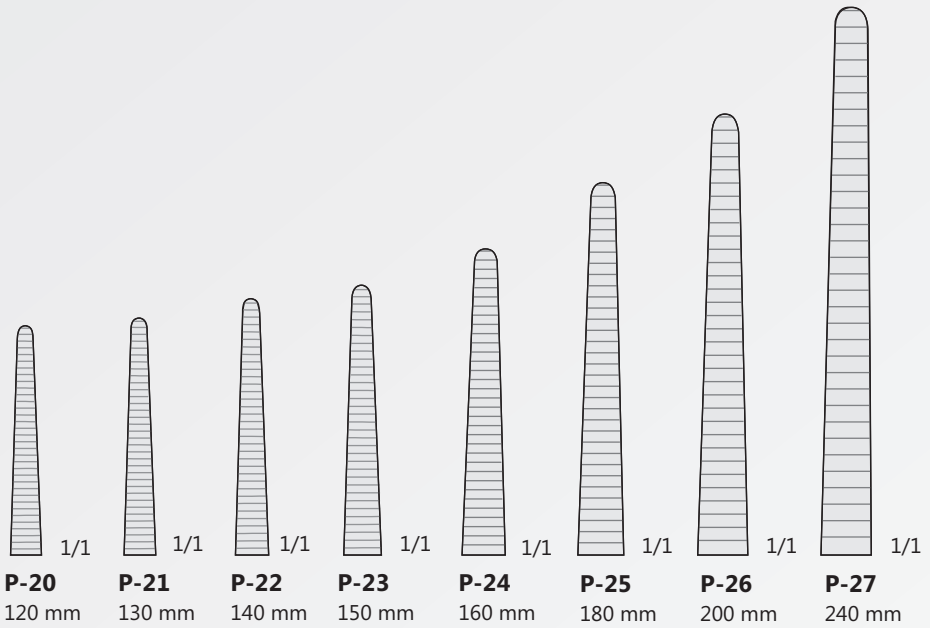

PEAN
P-30/P-37

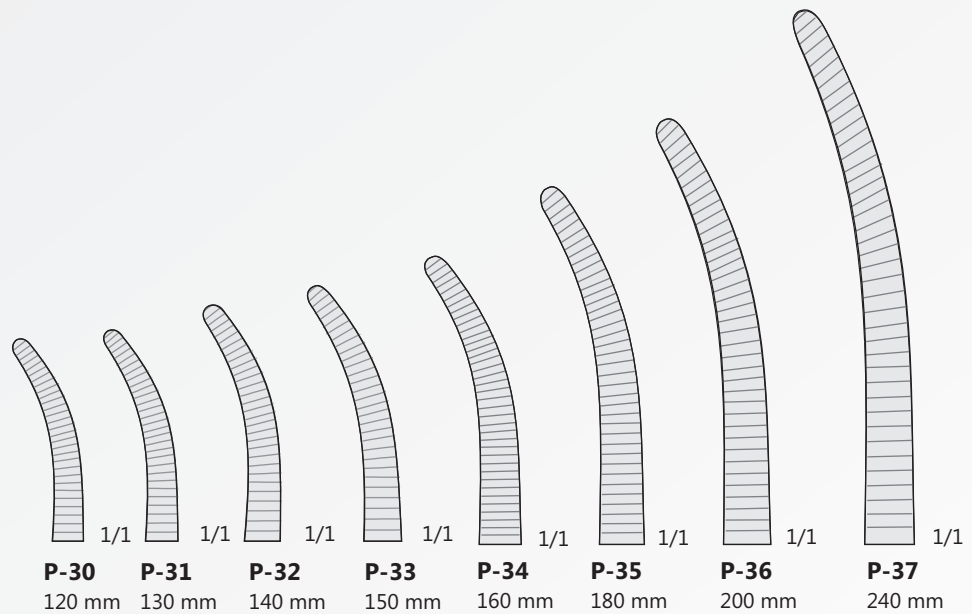

Arterienklemmen
Hemostatic forceps
Pinze emostatiche
Pinzas hemostáticas
Pincas hémostatiques

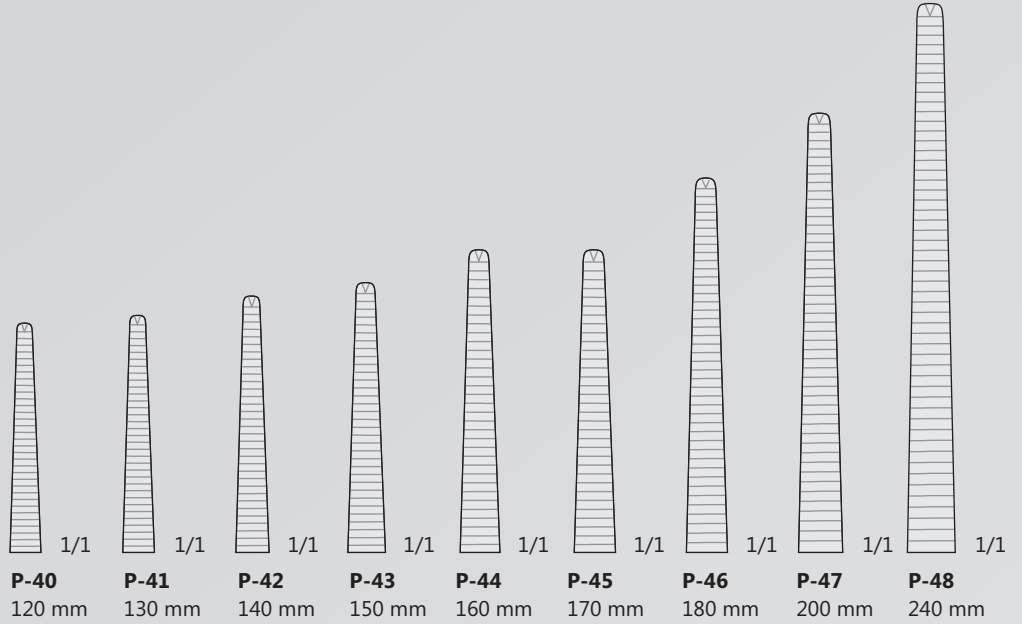
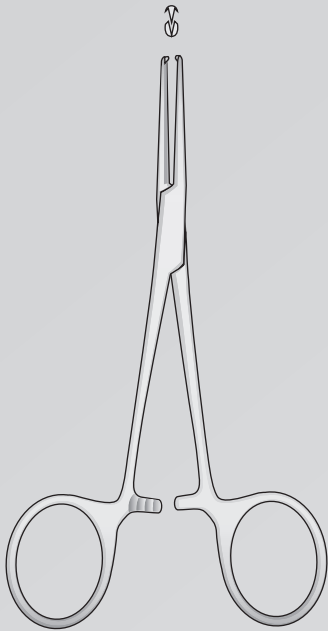

KOCHER
P-40/P-48

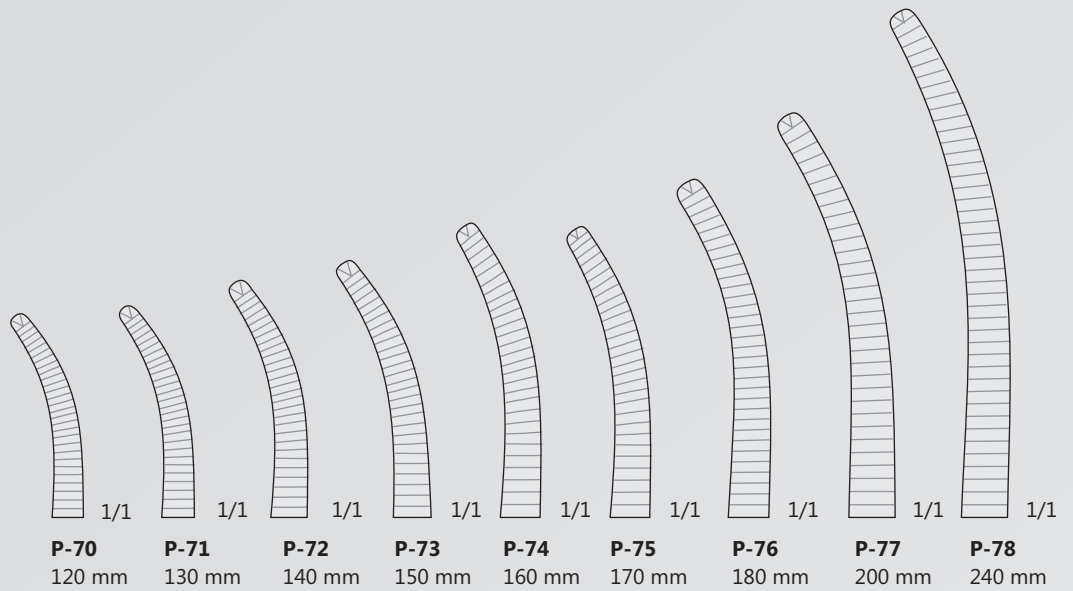
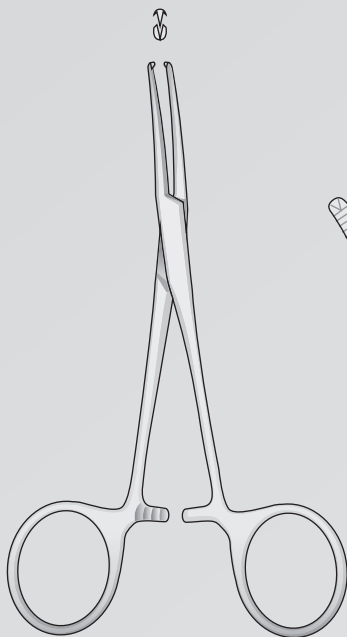

KOCHER
P-70/P-78

Arterienklemmen
Hemostatic forceps
Pinze emostatiche
Pinzas hemostáticas
Pincas hémostatiques

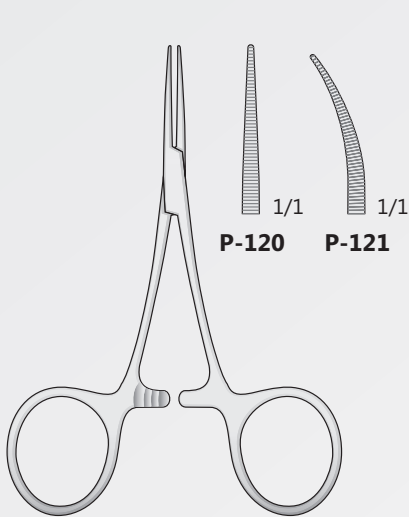

HARTMANN/BABY-MOSQUITO
P-120/P-121
95 mm

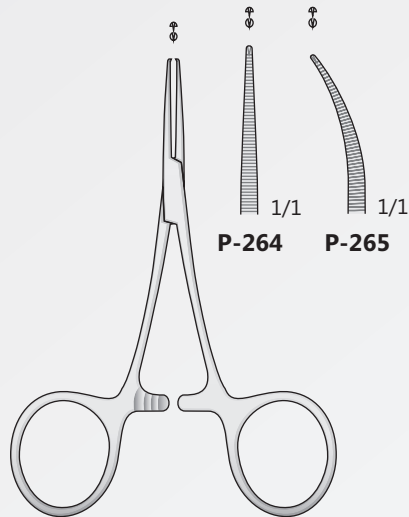

HARTMANN/BABY-MOSQUITO
P-264/P-265
95 mm

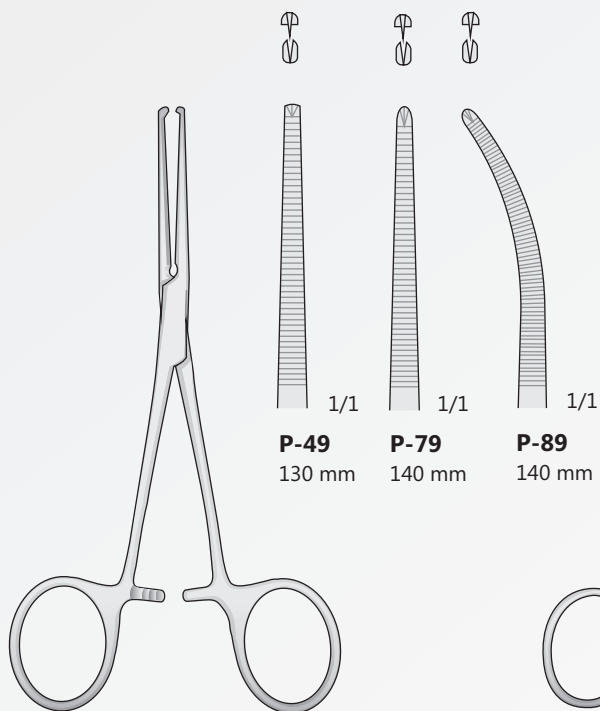

KOCHER
P-49/P-89

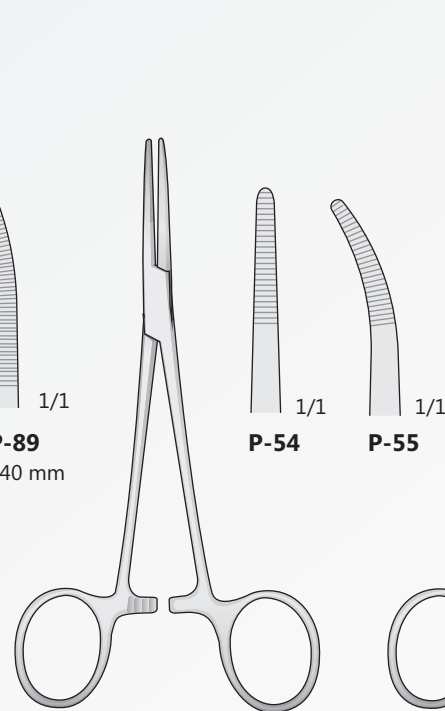

KELLY
P-54/P-55
140 mm

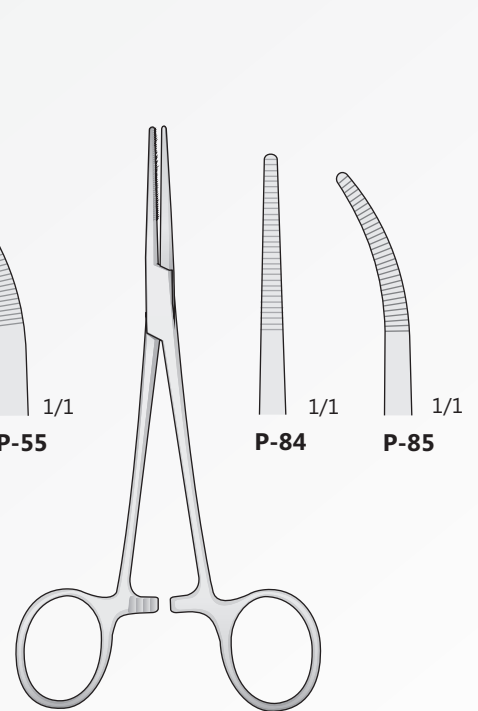

KELLY
P-84/P-85
140 mm

Arterienklemmen
Hemostatic forceps
Pinze emostatiche
Pinzas hemostáticas
Pincas hémostatiques

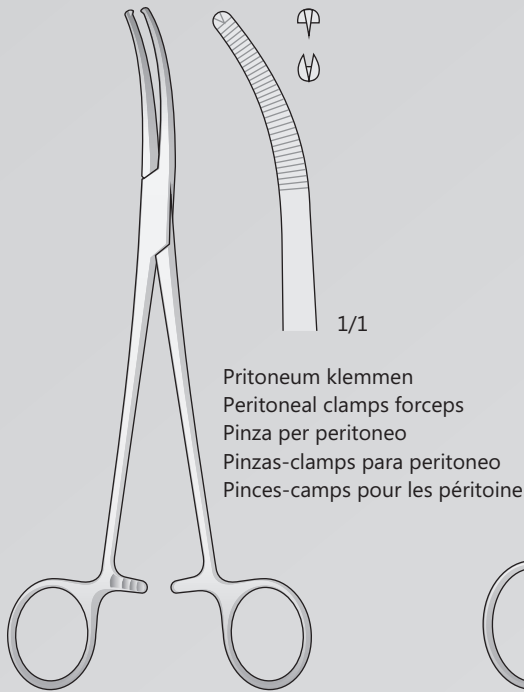

MIKULICZ
P-104
190 mm

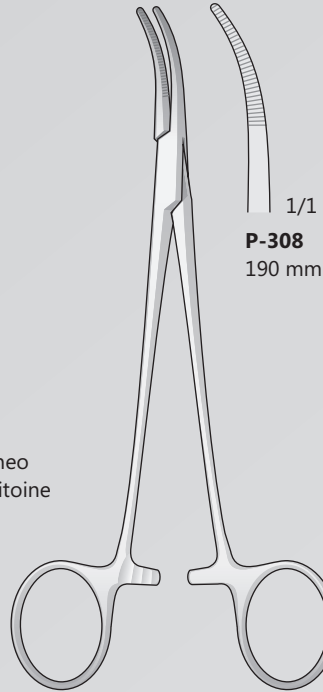

SCHNIDT
P-308
190 mm

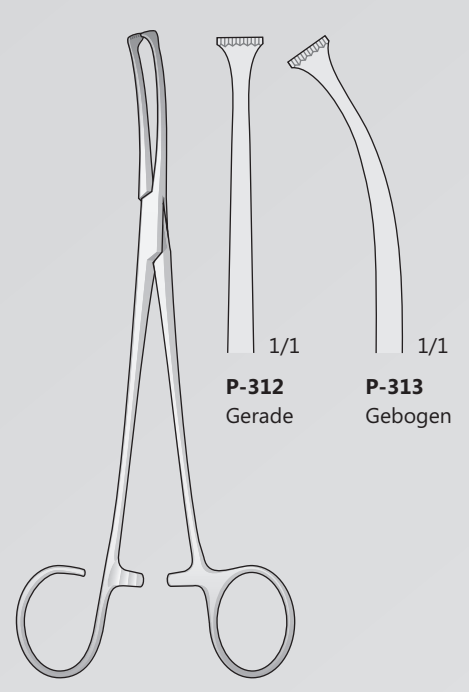

COLVER
P-312/P-313
190 mm

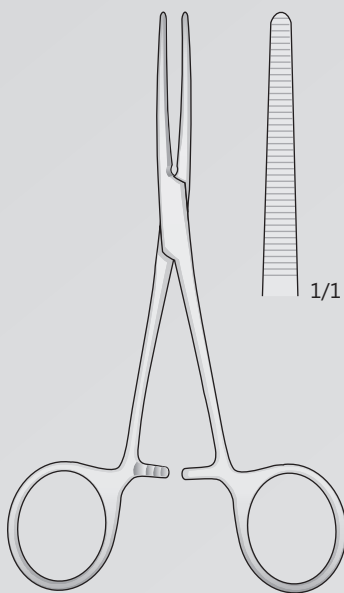

PEAN
P-17
140 mm

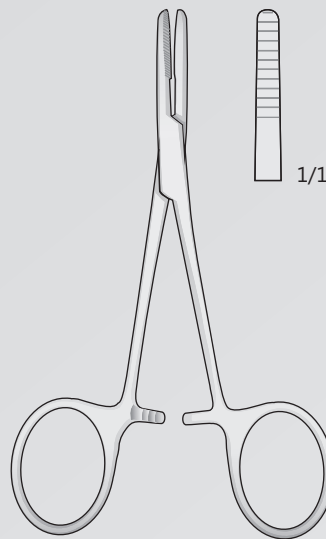

TERRIER
P-60
130 mm

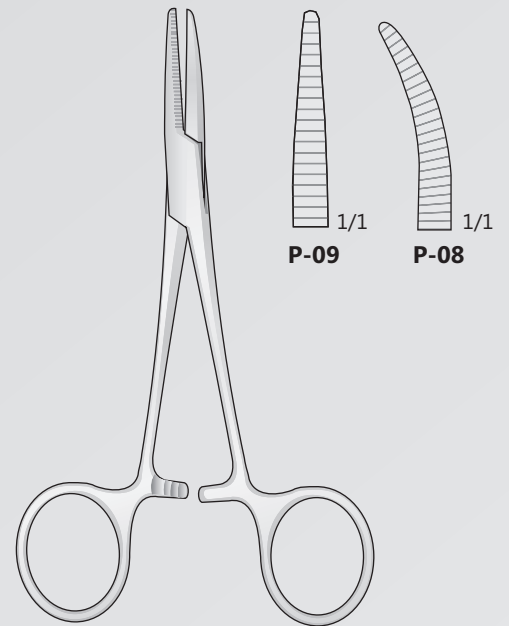

JONES
P-09/P-08
150 mm

Arterienklemmen
Hemostatic forceps
Pinze emostatische
Pinzas hemostáticas
Pincas hémostatiques

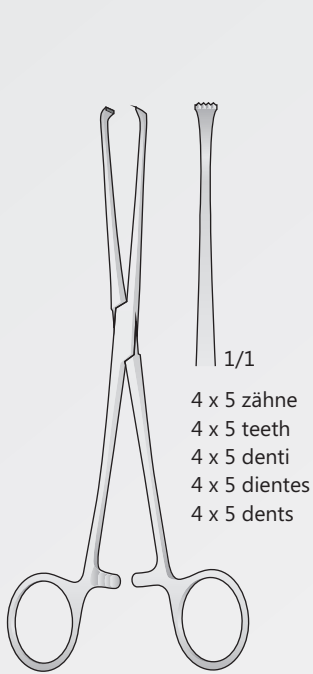

BABY-ALLIS
P-100
130 mm

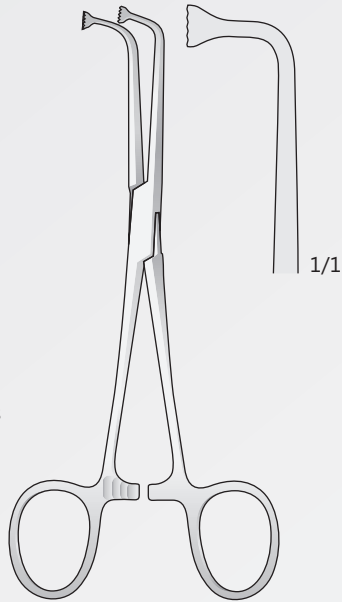

ALLIS
P-53
145 mm

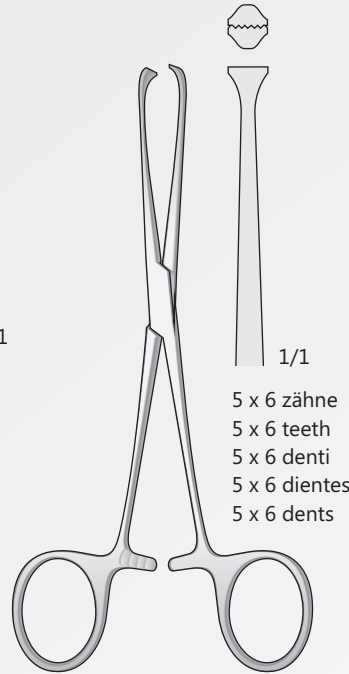

BOYS-ALLIS
P-129
150 mm

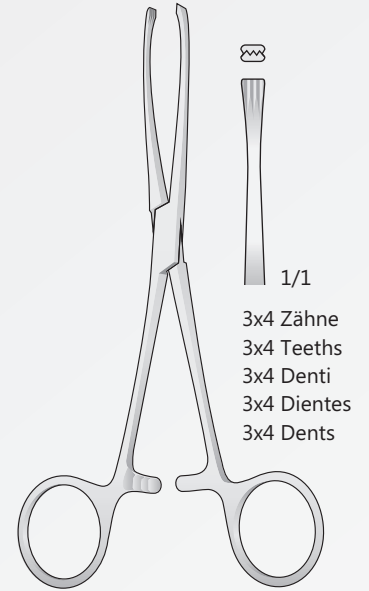

JUDD-ALLIS
P-324
155 mm

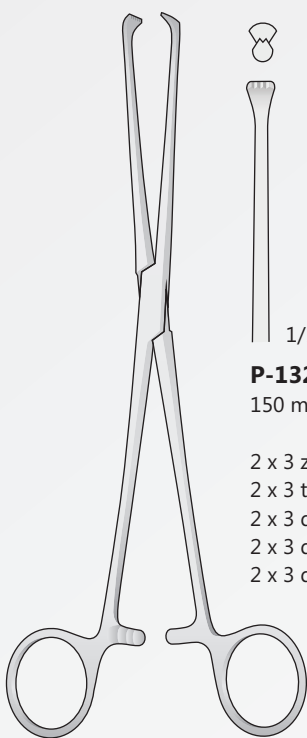

ALLIS
P-50/P-134

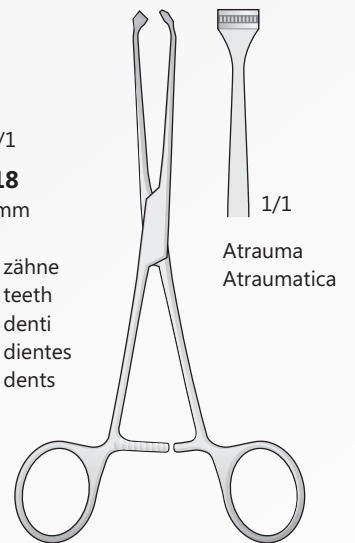
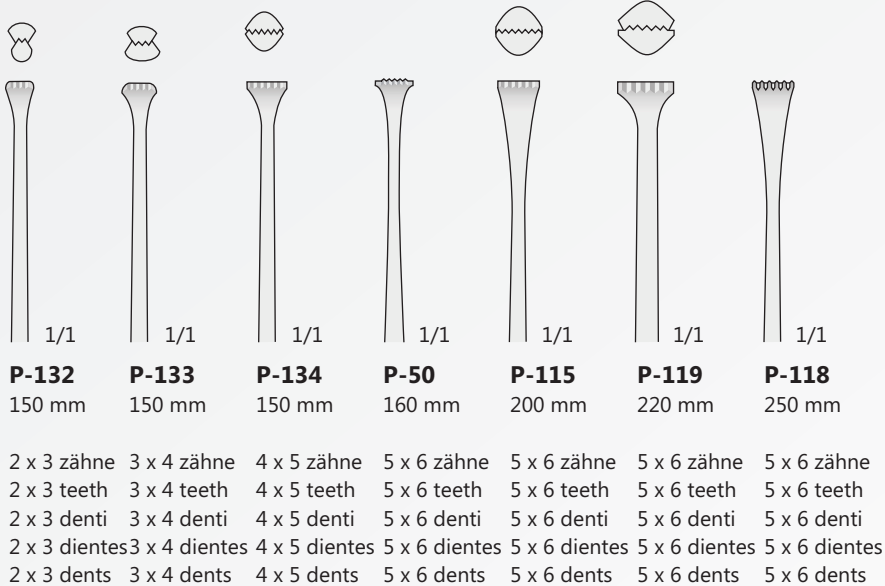

ALLIS
P-52
150 mm

Arterienklemmen
Hemostatic forceps
Pinze emostatiche
Pinzas hemostáticas
Pincas hémostatiques

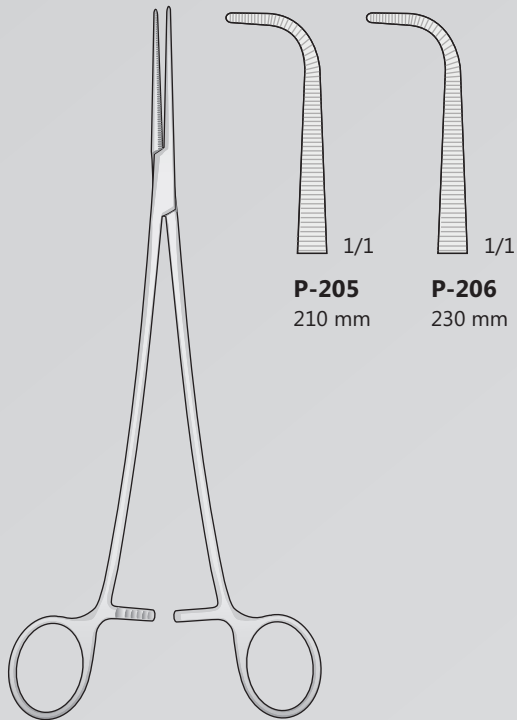

BENGOLEA
P-205/P-206

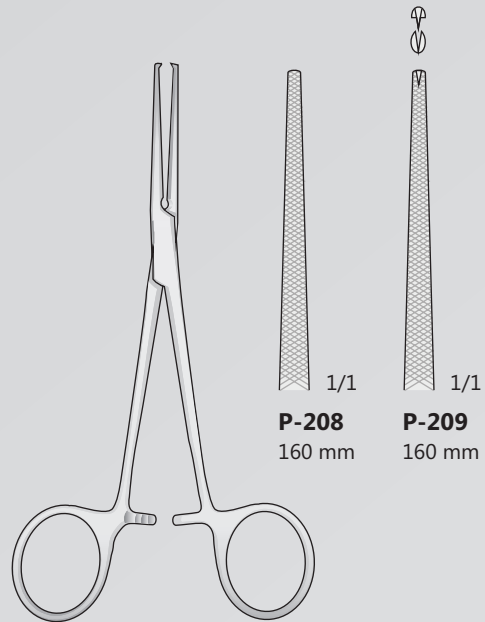

DIXON-LOVELACE
P-208/P-209

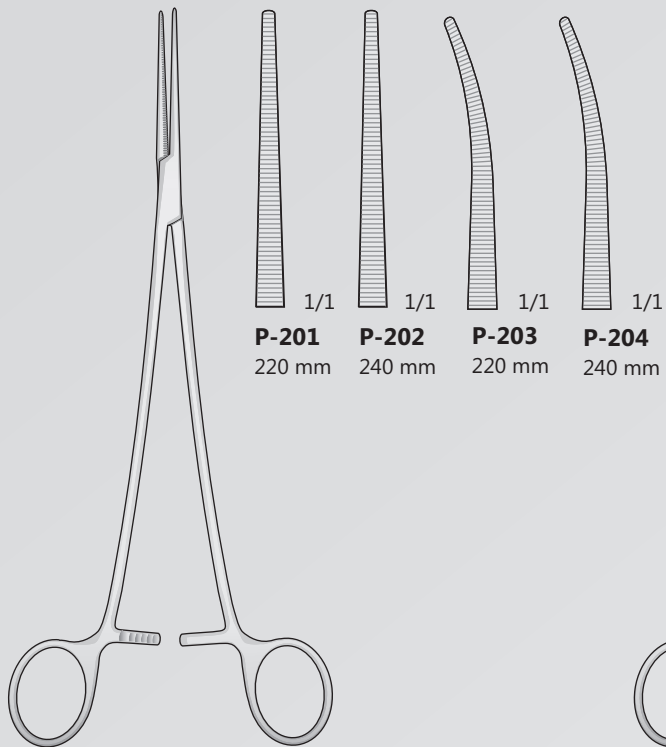

BENGOLEA
P-201/P-204

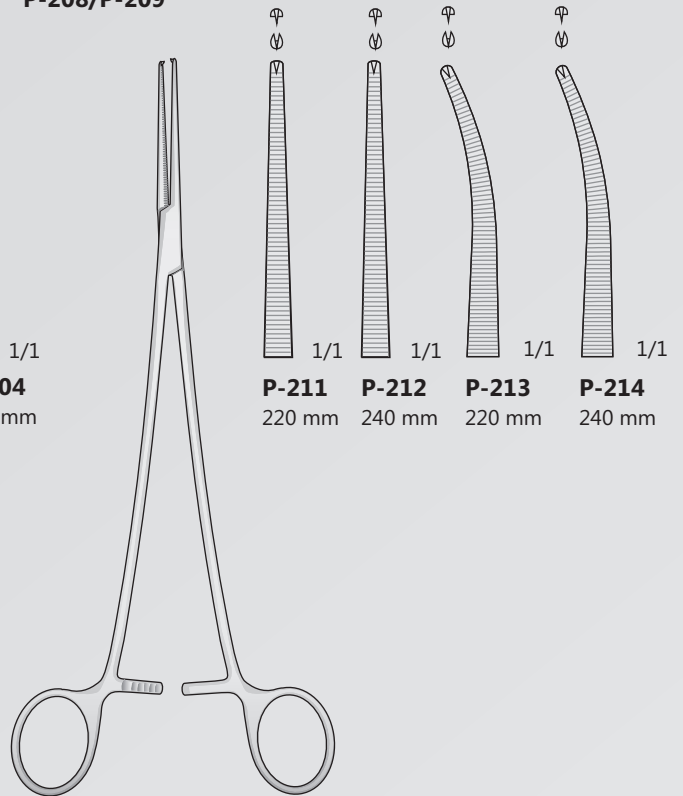

BENGOLEA
P-211/P-214

Arterienklemmen Präparier und Ligaturklemmen
Artery forceps for preparation and ligature
Pinze emostatiche per preparazioni e legature
Pinzas hemostáticas Preparacion y para ligaduras
Pinces hemostatiques à disséquer et à ligatures

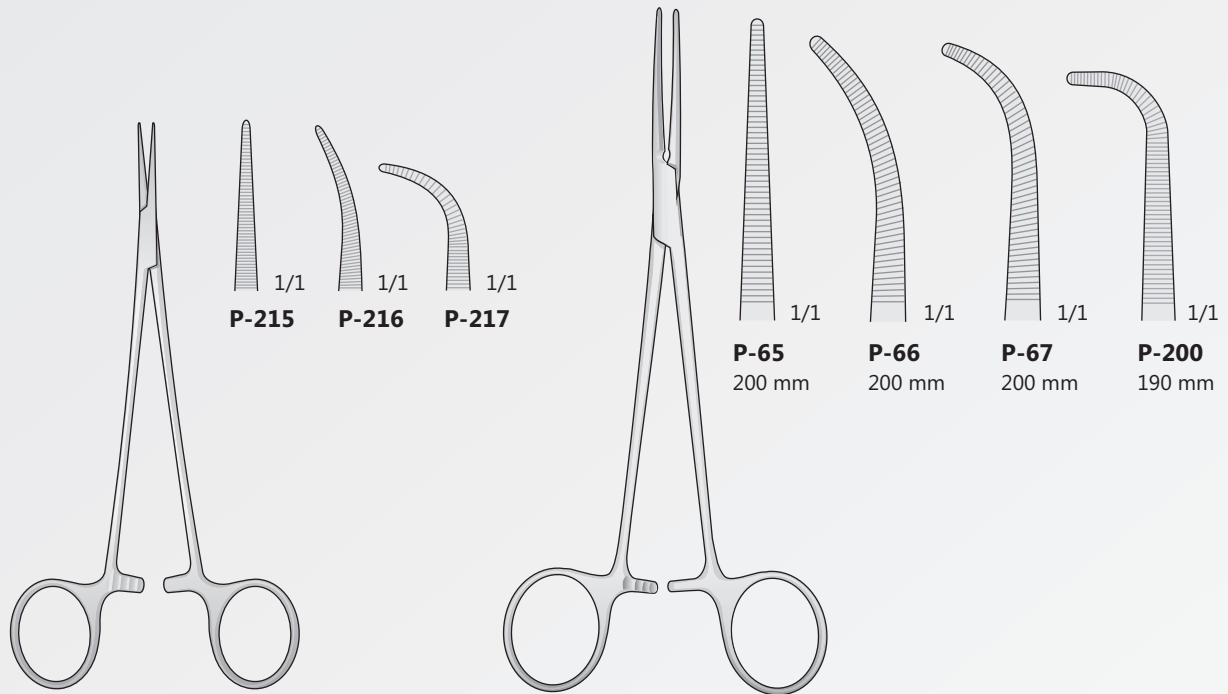

P-215/P-217
160 mm

HEISS
P-65/P-200

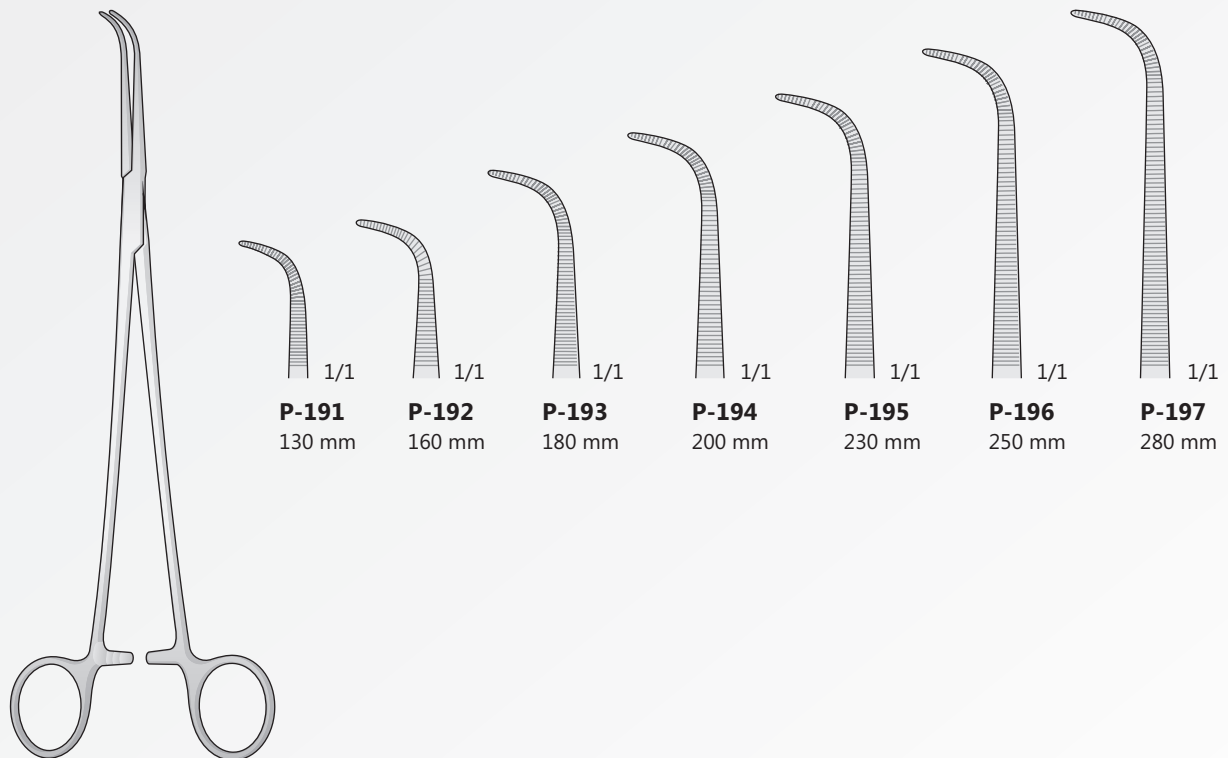

GEMINI
P-191/P-197

Arterienklemmen Präparier und Ligaturklemmen
 Artery forceps for preparation and ligature
 Pinze emostatiche per preparazioni e legature
 Pinzas hemostáticas Preparacion y para ligaduras
 Pincas hemostàtiques à disséquer et à ligatures

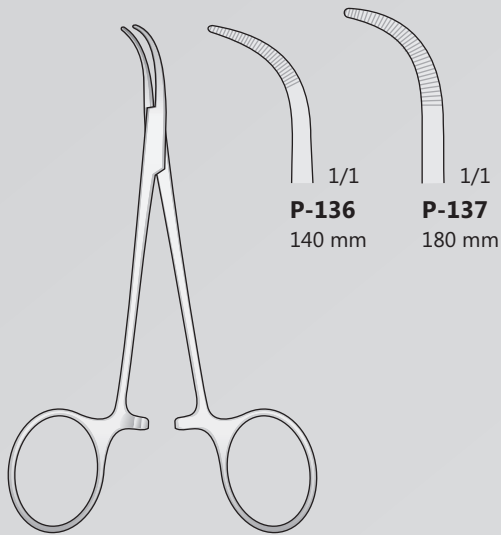

BABY-MIXTER
P-136/P-137

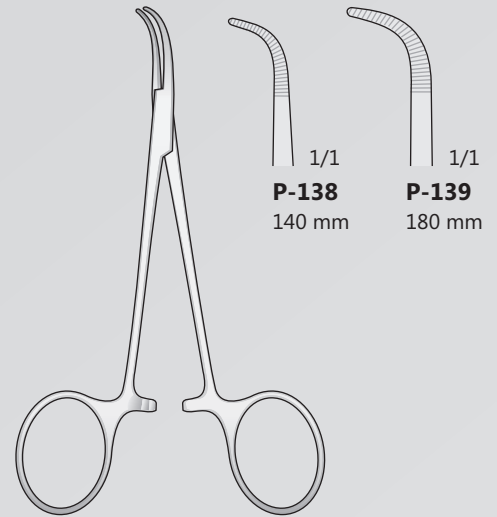

BABY-ADSON
P-138/P-139

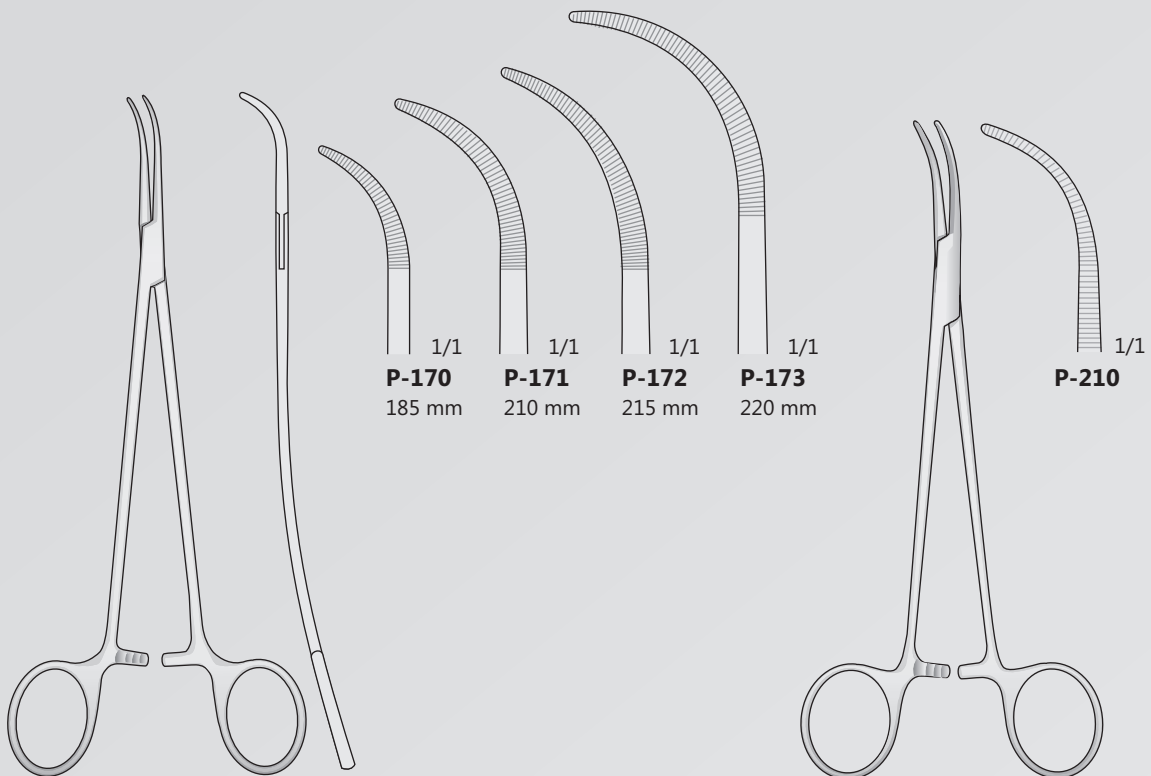

P-170/P-173

ROCHESTER-PEAN
P-210
180 mm

Arterienklemmen Präparier und Ligaturklemmen
 Artery forceps for preparation and ligature
 Pinze emostatiche per preparazioni e legature
 Pinzas hemostáticas Preparacion y para ligaduras
 Pincas hemostàtiques à disséquer et à ligatures

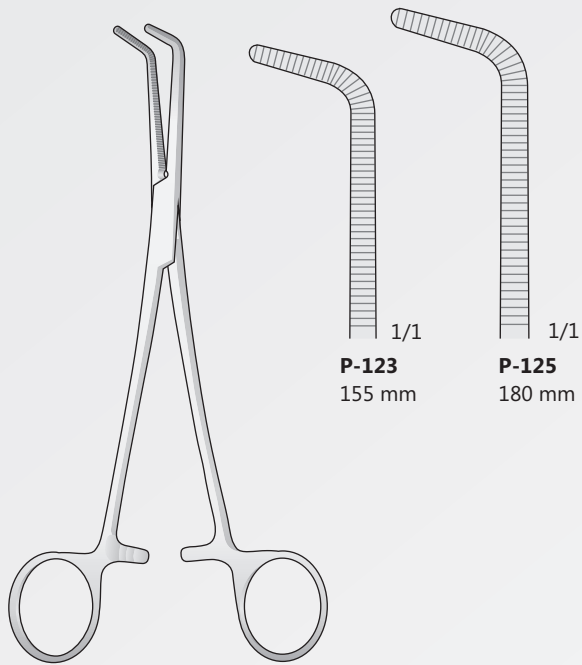

P-123
155 mm

P-125
180 mm

MIXTER
P-123/P-125

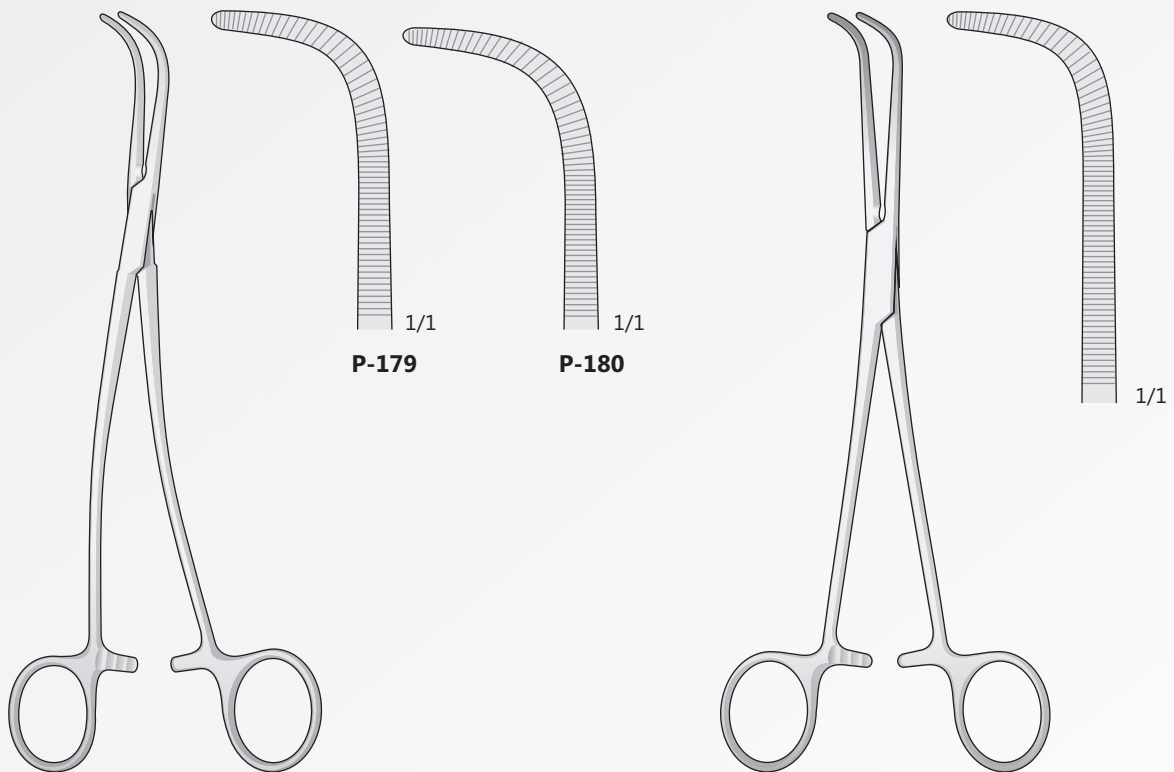

P-179

P-180

1/1

GRAY
P-179/P-180
220 mm

WIKSTROEM
P-181
205 mm

Arterienklemmen
Hemostatic forceps
Pinze emostatiche
Pinzas hemostáticas
Pincas hémostatiques

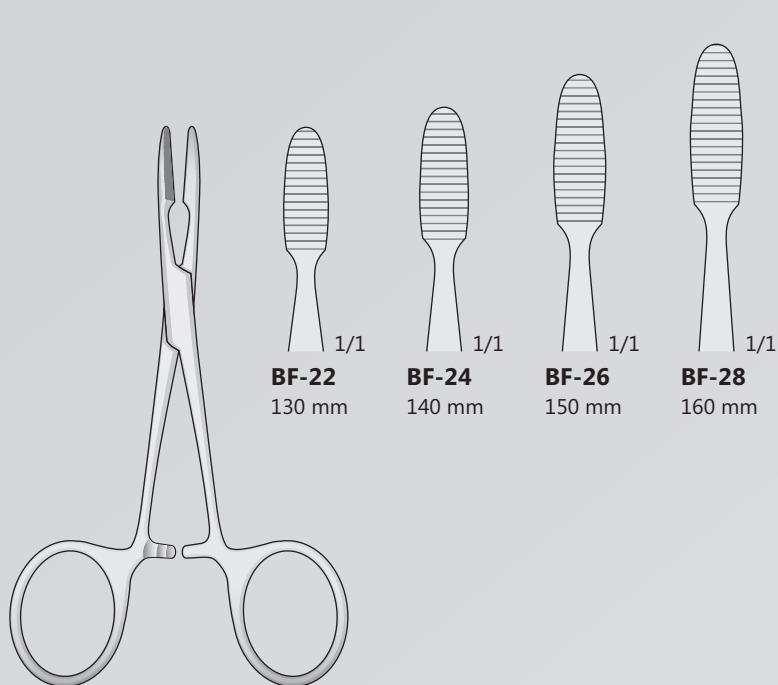

PEAN-MURPHY
BF-22/BF-28

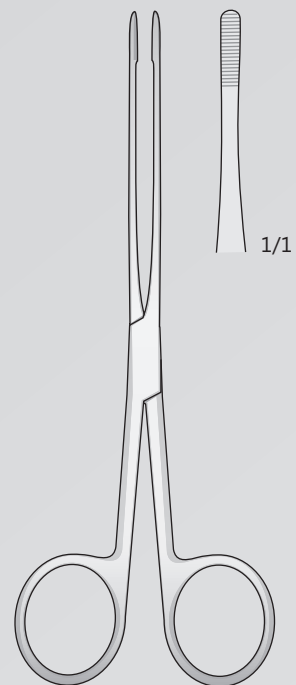

LISTER
BF-20
150 mm

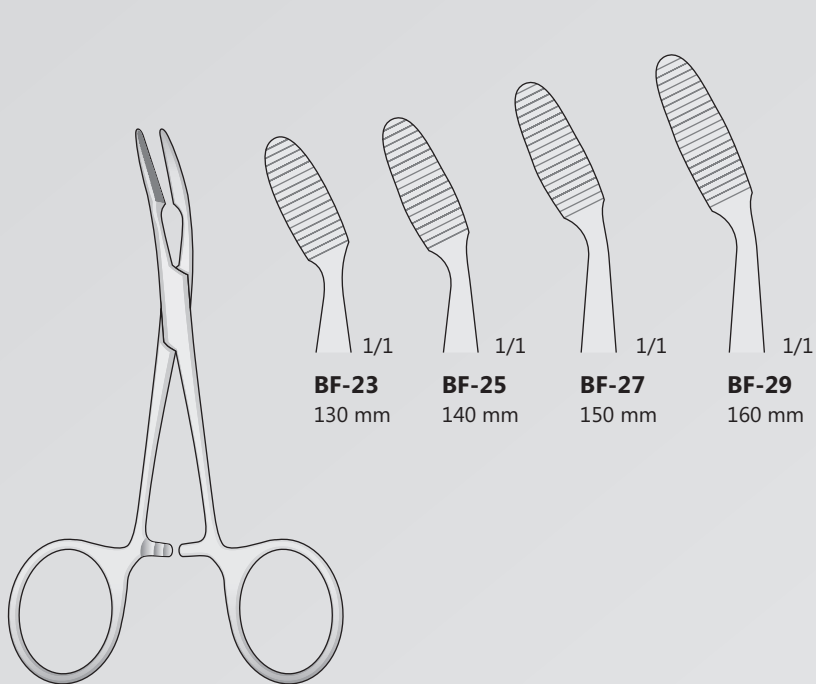

PEAN-MURPHY
BF-23/BF-29

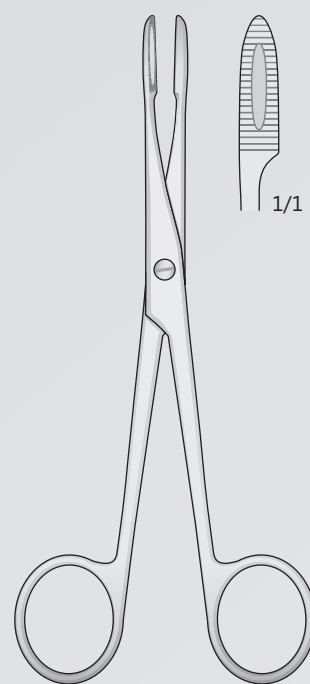

GROSS
BF-10 - 130 mm
BF-12 - 160 mm

Schwamm und tamponzangen
Sponge and dressing forceps
Pinze per tamponi
Pinzas para tampones
Pinces à tampons

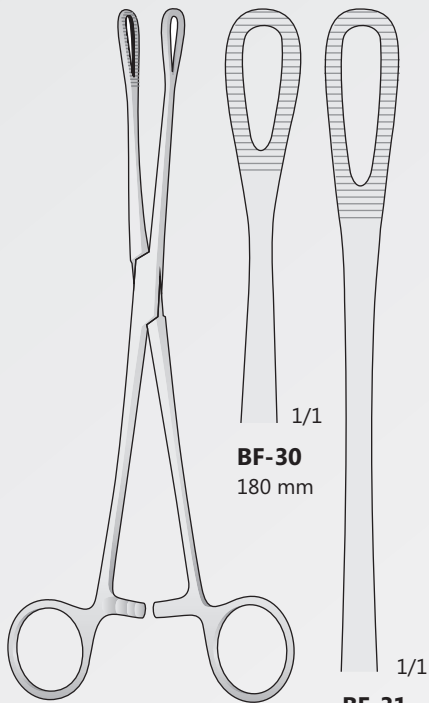

RAMPLEY
BF-30/BF-31

BF-30
180 mm

BF-31
245 mm

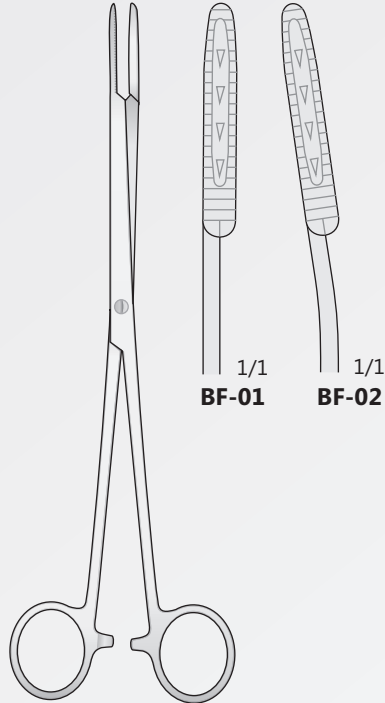

MAIER
BF-01/BF-02
245 mm

BF-01 1/1
BF-02 1/1

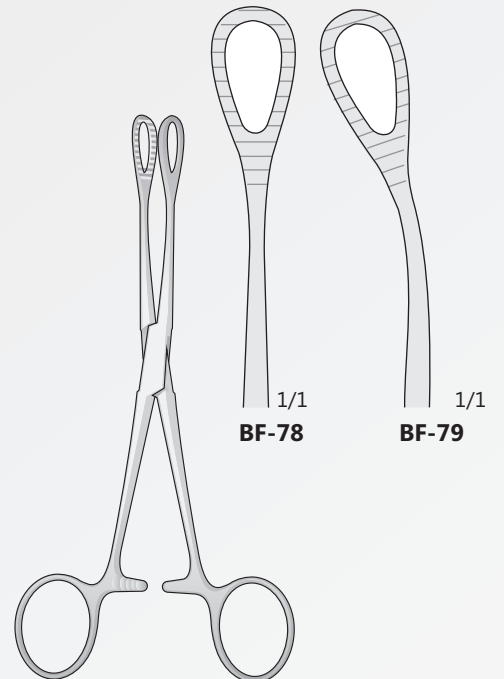

FOERSTER-BALLENGER
BF-78/BF-79
180 mm

BF-78 1/1
BF-79 1/1

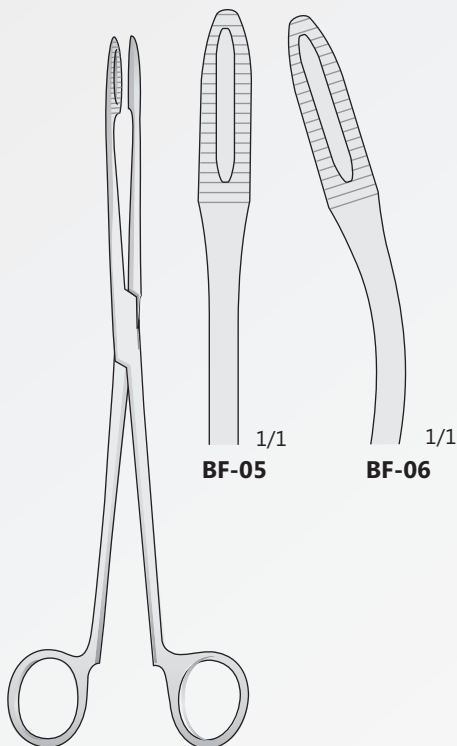

MAIER
BF-05/BF-06
265 mm

BF-05 1/1
BF-06 1/1

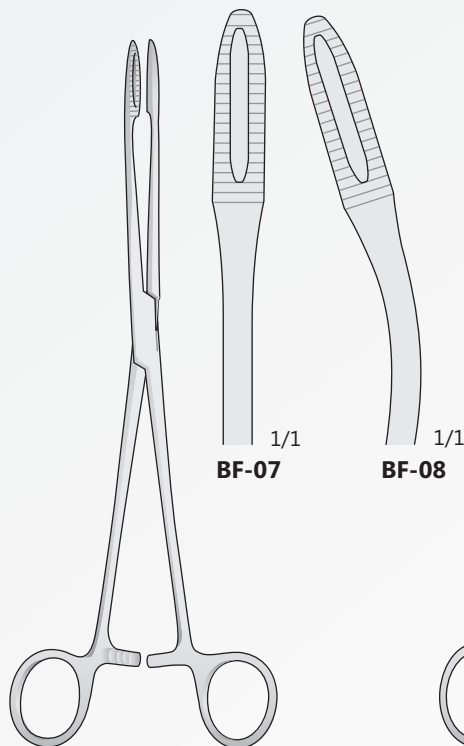

MAIER
BF-07/BF-08
265 mm

BF-07 1/1
BF-08 1/1

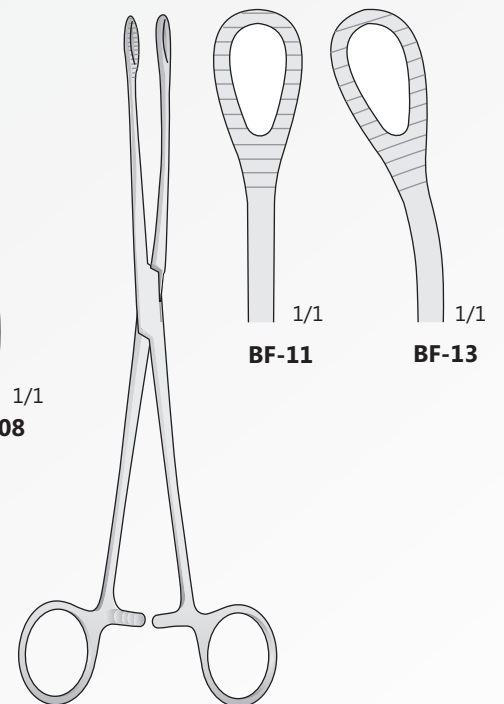

FOERSTER-BALLENGER
BF-11/BF-13
240 mm

BF-11 1/1
BF-13 1/1

Tuchklemmen
Towel clamps
Fissateli
Pinzas de campo
Pinces pour fixer les compresses

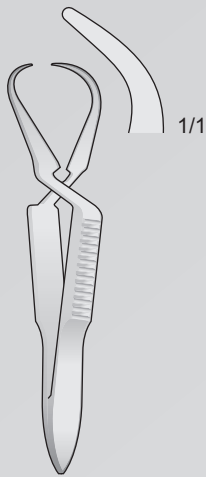

BF-37
55 mm

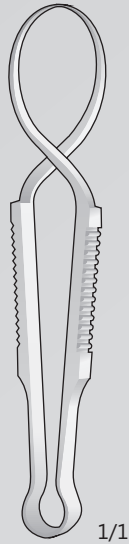

SCHAEDEL
BF-38
85 mm

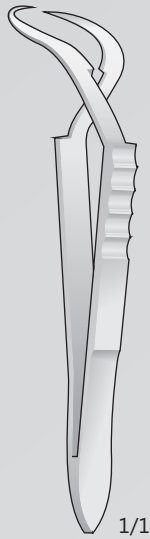

JONES
BF-48
90 mm

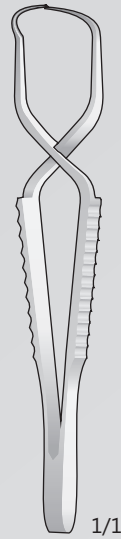

FAURE
BF-40
85 mm

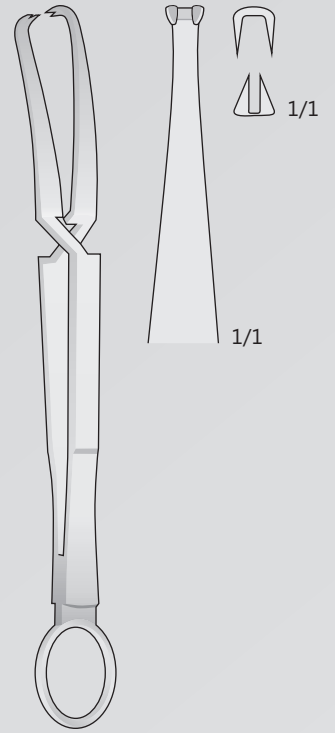

DOYEN
BF-36
180 mm

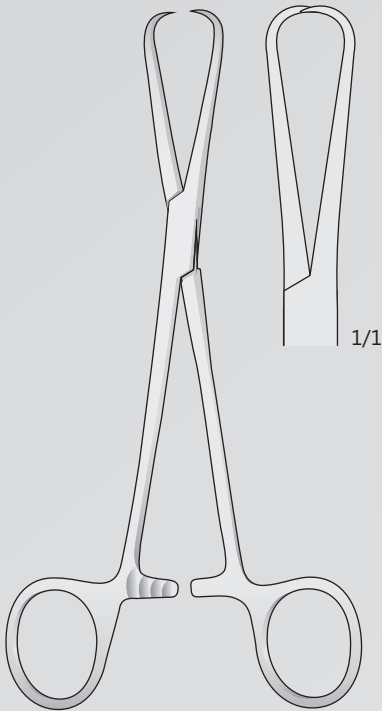

BERNHARD
BF-82
165 mm

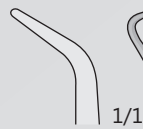

1/1



1/1

BF-42
90 mm



1/1

BF-41
100 mm

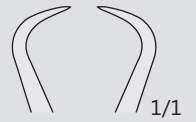

1/1

BF-44
110 mm

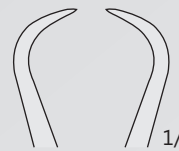

1/1

BF-46
130 mm

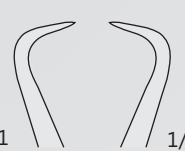

1/1

BF-43
135 mm

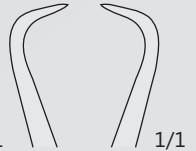

1/1

BF-45
140 mm

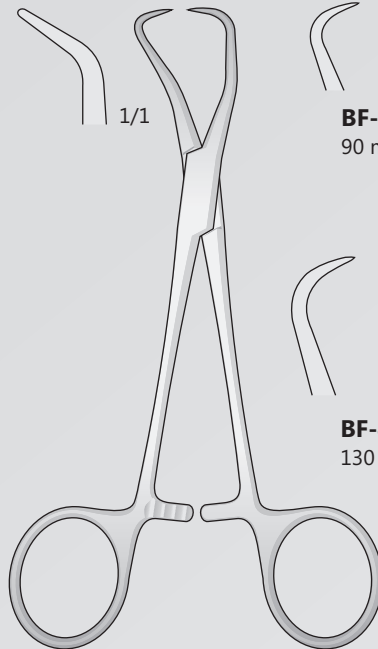

BACKHAUS
BF-42/BF-46

Bulldogklemmen
Bulldog clamps
Pinze Bulldog
Pinzas Bulldog
Pincas Bulldog

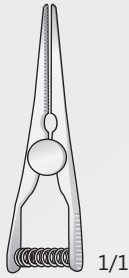

FB-84
35 mm

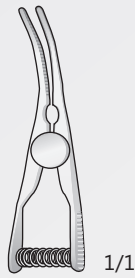

FB-85
35 mm

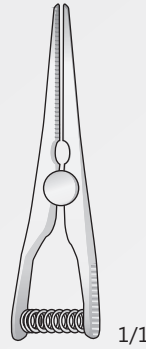

FB-86
45 mm

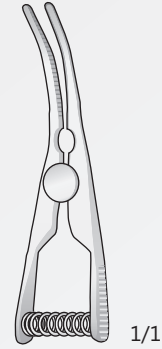

FB-87
45 mm

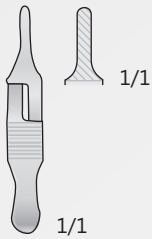

BM-27
30 mm

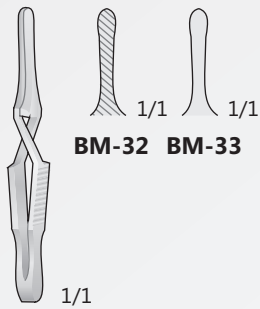

DIFFENBACH
BM-32/BM-33
40 mm

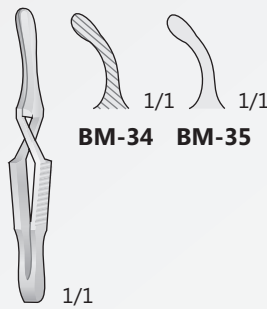

DIFFENBACH
BM-34/BM-35
40 mm

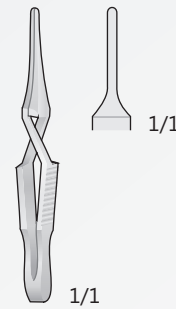

BM-93
40 mm

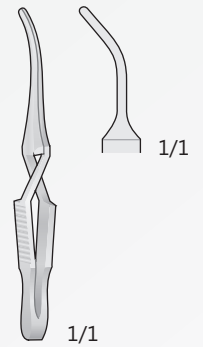

BM-95
45 mm

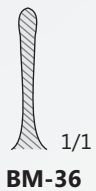

BM-36



DIFFENBACH
BM-36/BM-37
45 mm

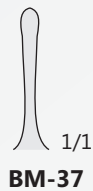

BM-37

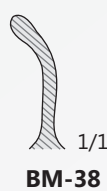

BM-38

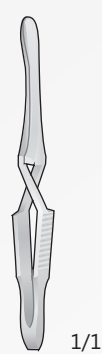

DIFFENBACH
BM-38/BM-39
45 mm

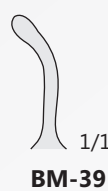

BM-39

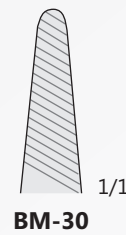

BM-30



DIFFENBACH
BM-30/BM-31
60 mm

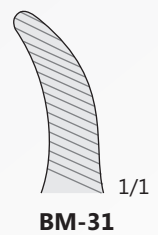

BM-31



BONTEMPI
CHIRURGISCHE INSTRUMENTE

Atraumatische Gefäßklemmen
Atraumatic Vessel Clamps
Enterostati, Pinze atraumatiche
Pinzas vasculares atraumáticas
Pinces atraumatiques

Atraumatische Gefäßklemmen
Atraumatic vessel clamps
Pinze vascolari atraumatiche
Pinzas vasculares atraumáticas
Pincas hémostatiques atraumatiques

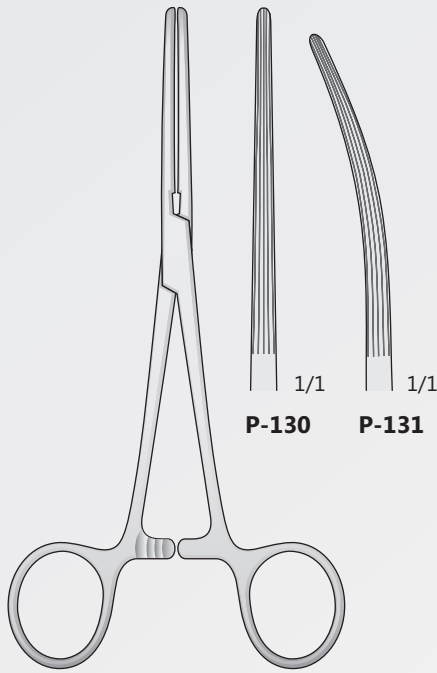

BAINBRIDGE
P-130/P-131
150 mm

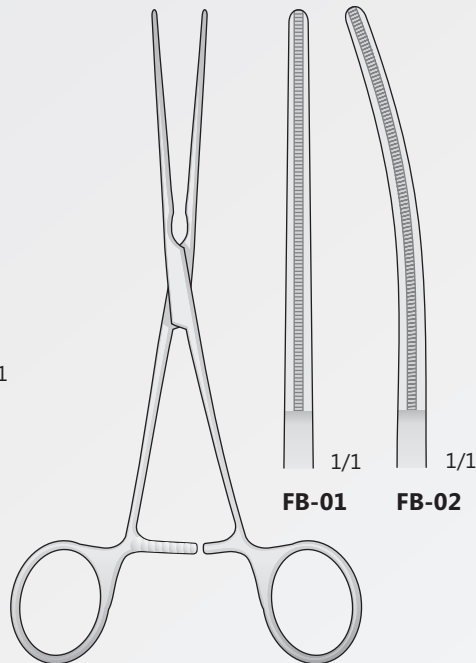

 De BAKEY - BAINBRIDGE
FB-01/FB-02
180 mm

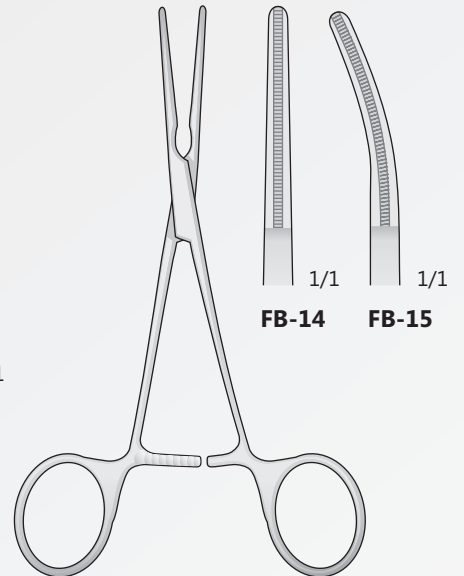

 De BAKEY - BAINBRIDGE
FB-14/FB-15
155 mm

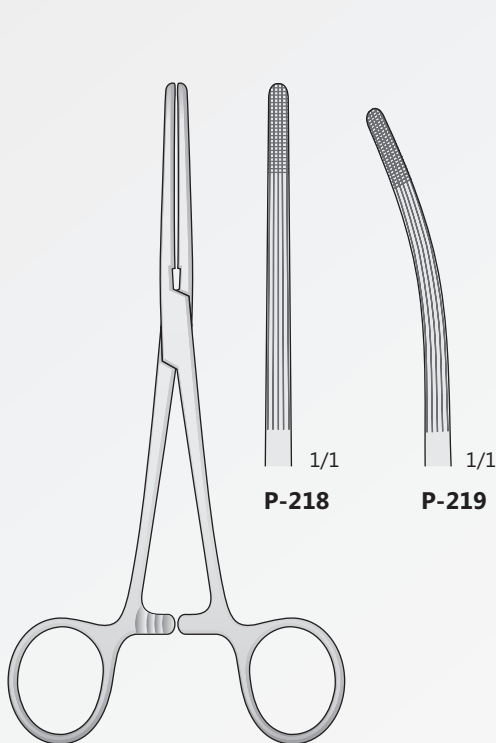

ROCHESTER-CARMALT
P-218/P-219
160 mm

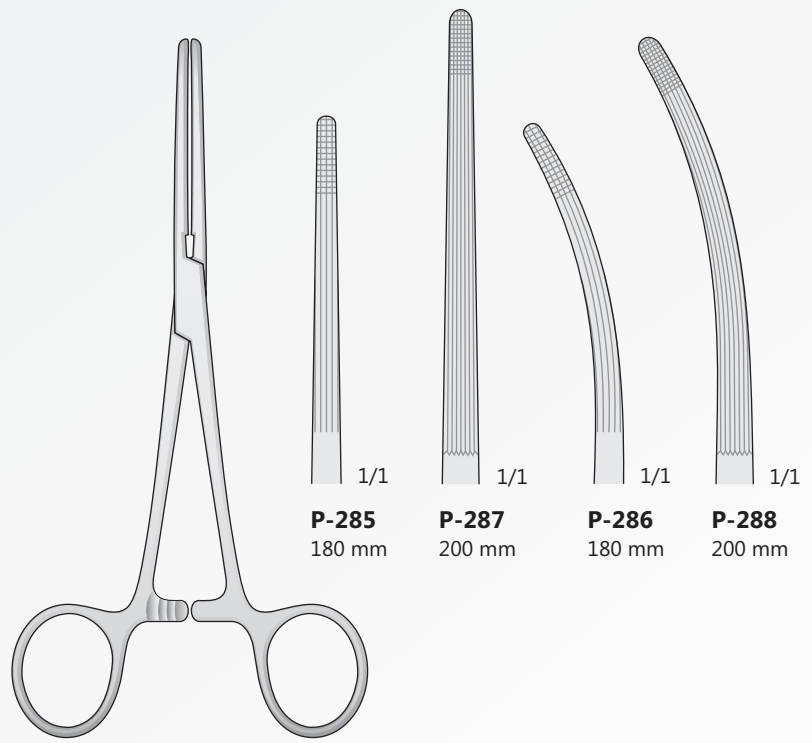

ROCHESTER-CARMALT
P-285/P-288

Darmklemmen Elastisch
Intestinal clamps soft elastic
Pinze intestinali elastiche
Pinzas intestinales
Pincas intestinales

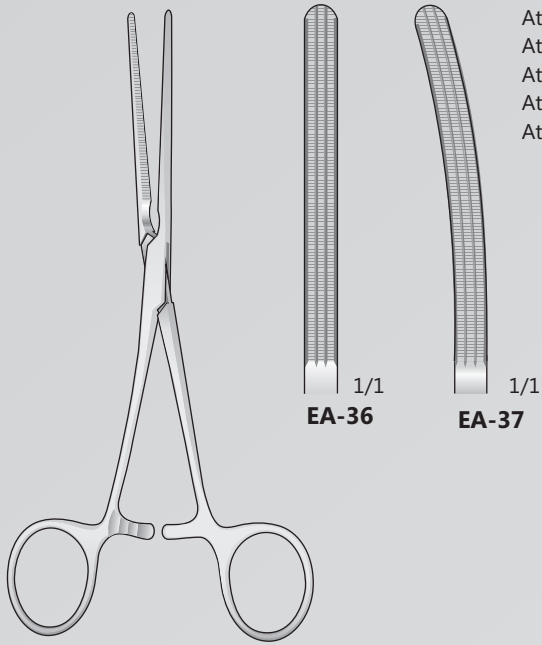

DOYEN
EA-36/EA-37
170 mm

Atraumatische
Atraumatic
Atraumatische
Atraumàticas
Atraumatiques

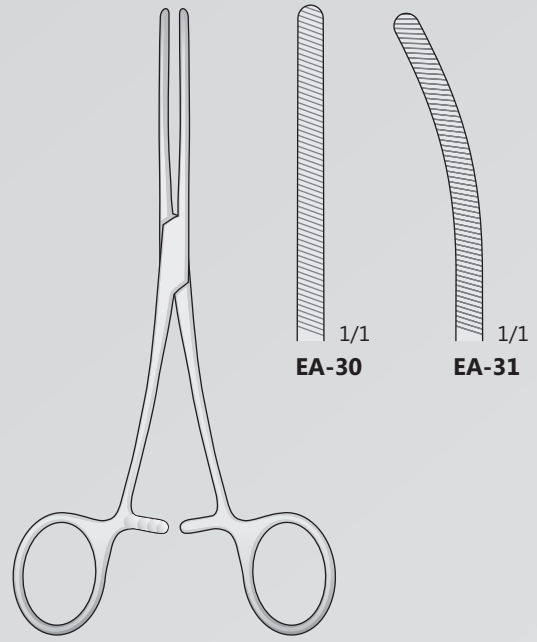

DOYEN
EA-30/EA-31
170 mm

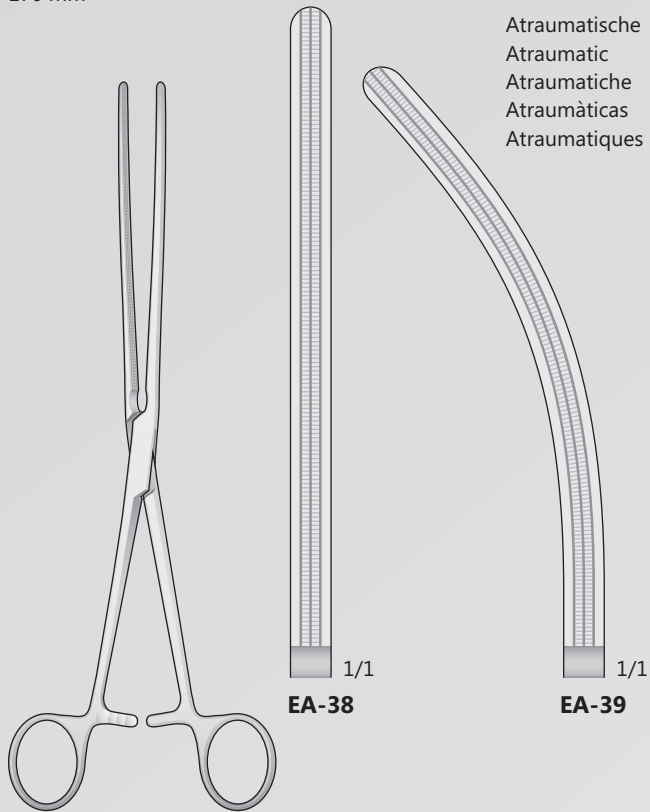

DOYEN
EA-38/EA-39
230 mm

Atraumatische
Atraumatic
Atraumatische
Atraumàticas
Atraumatiques

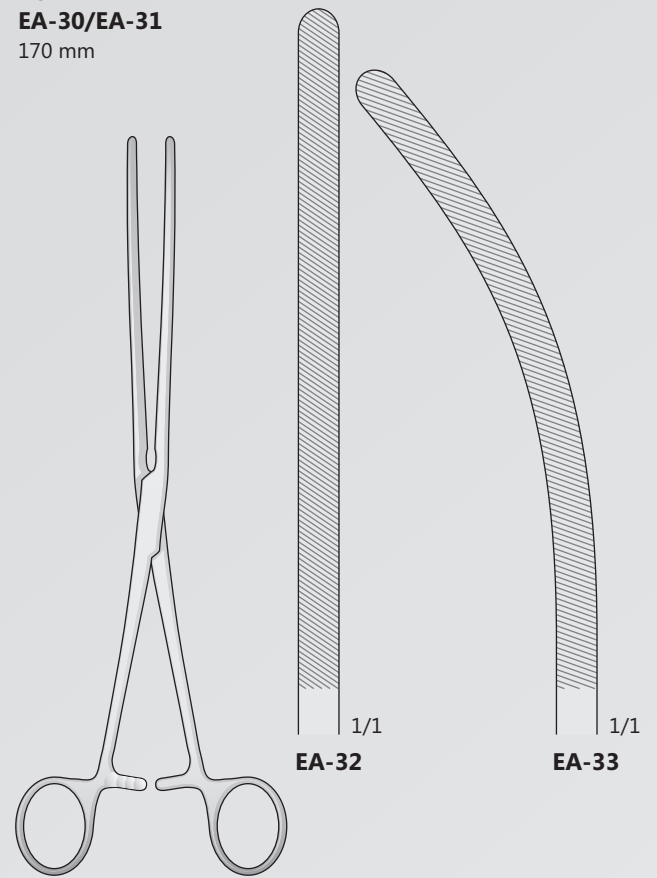

DOYEN
EA-32/EA-33
230 mm

Darmklemmen Elastisch
Intestinal clamps soft elastic
Pinze intestinali elastiche
Pinzas intestinales
Pincas intestinales

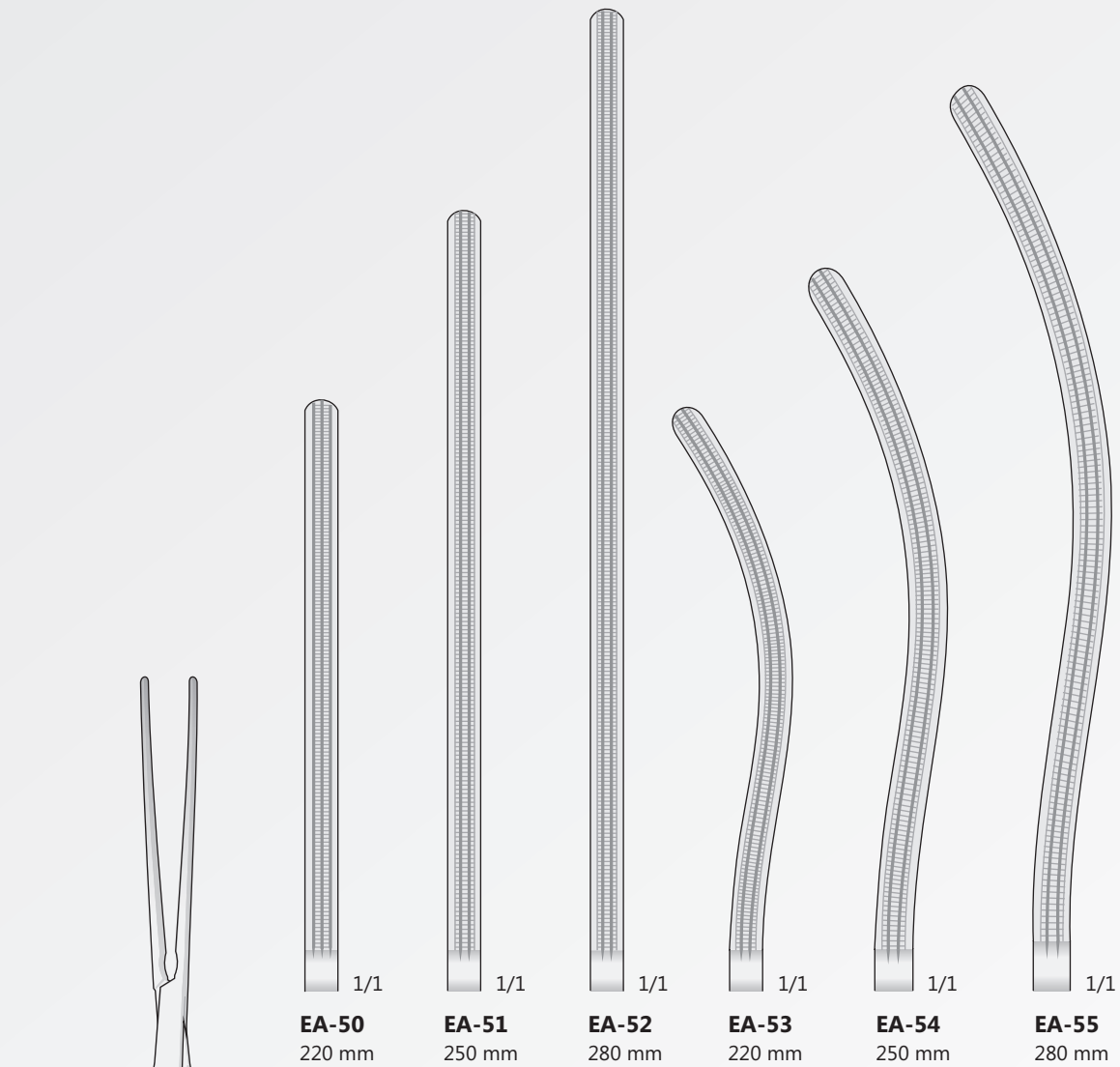

Atraumatische
Atraumatic
Atraumatiche
Atraumáticas
Atraumatiques



KOCHER
EA-50/EA55

Darmklemmen Elastisch
Intestinal clamps soft elastic
Pinze intestinali elastiche
Pinzas intestinales
Pincas intestinales

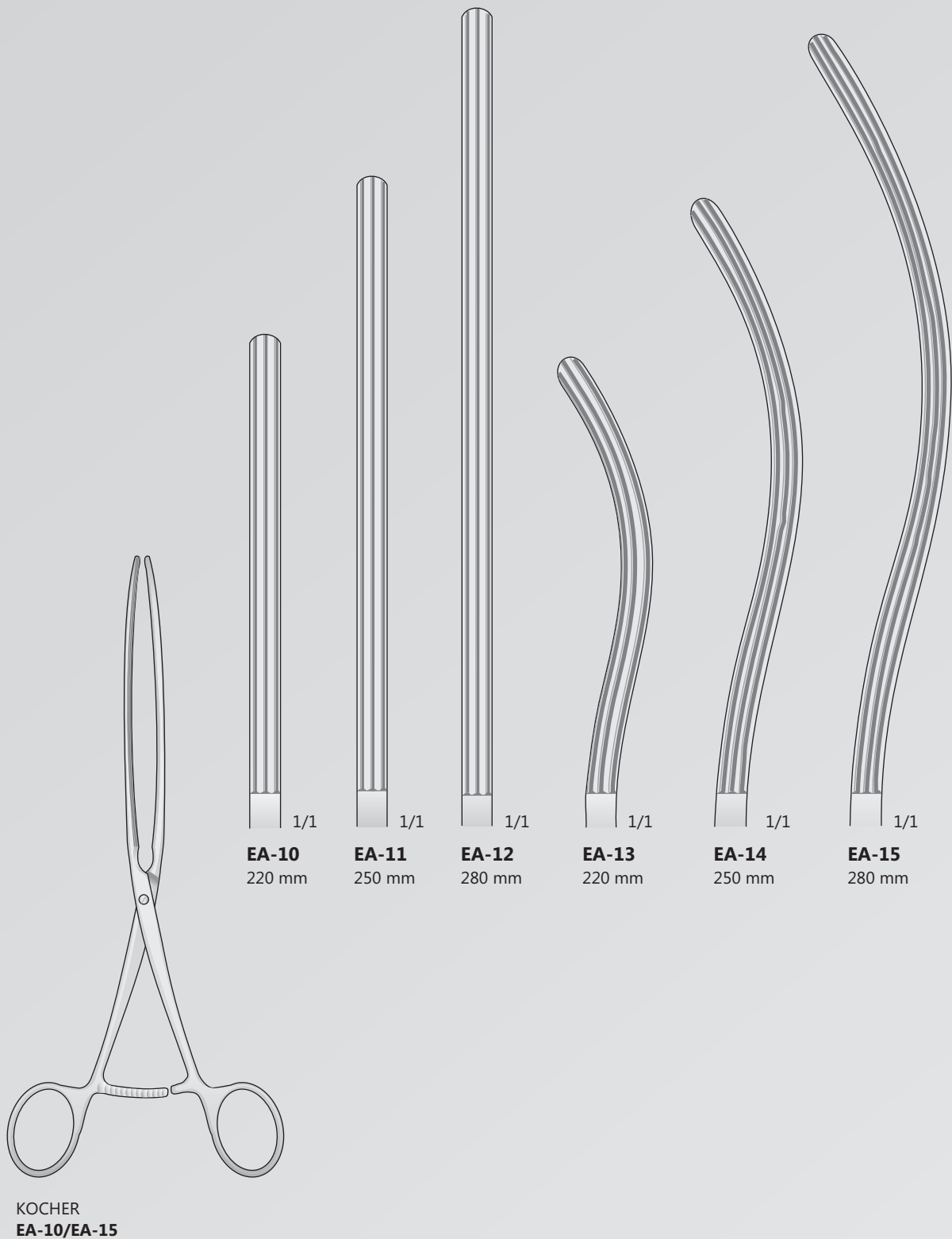

Darmklemmen Elastisch
Intestinal clamps soft elastic
Pinze intestinali elastiche
Pinzas intestinales
Pincas intestinales

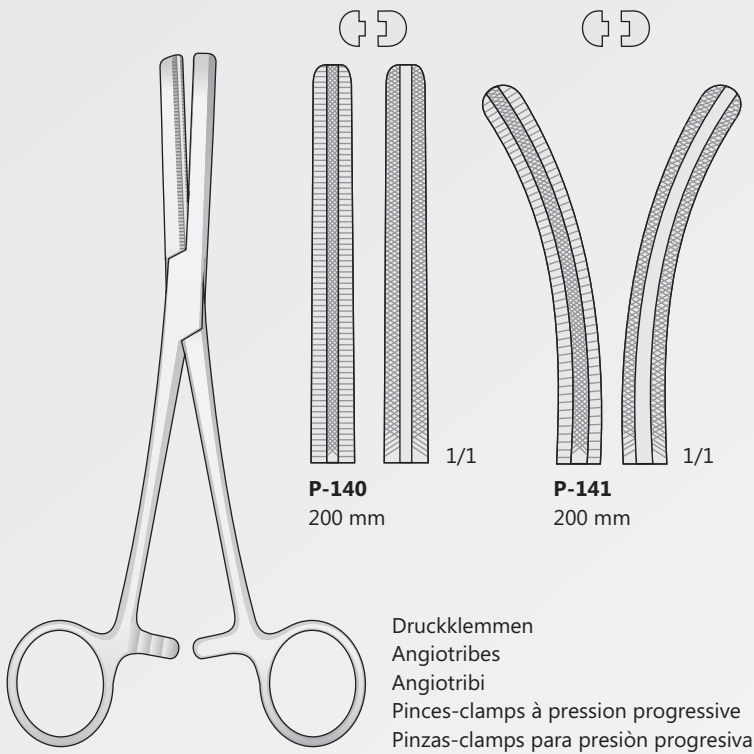

P-140
200 mm

P-141
200 mm

Druckklemmen
Angiotribes
Angiotribi
Pincas-clamps à pression progressive
Pinzas-clamps para presión progresiva

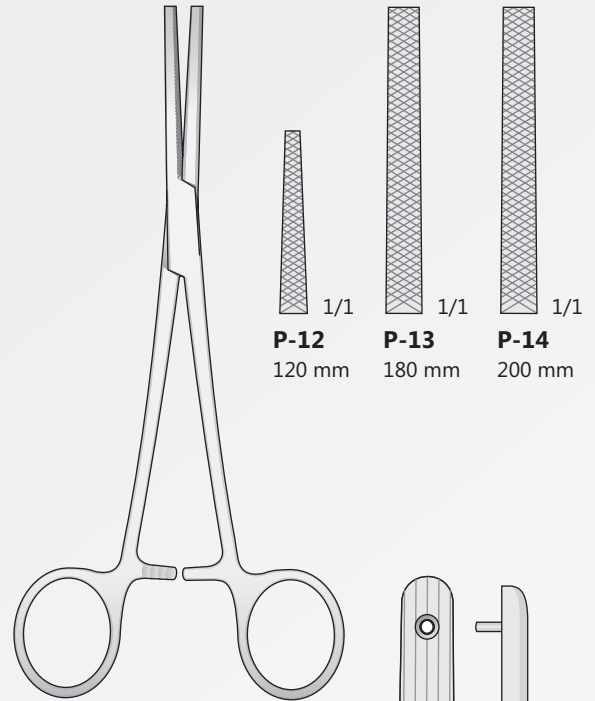

P-12
120 mm

P-13
180 mm

P-14
200 mm

P-12/P-14

FERGUSSON
P-140/P-141

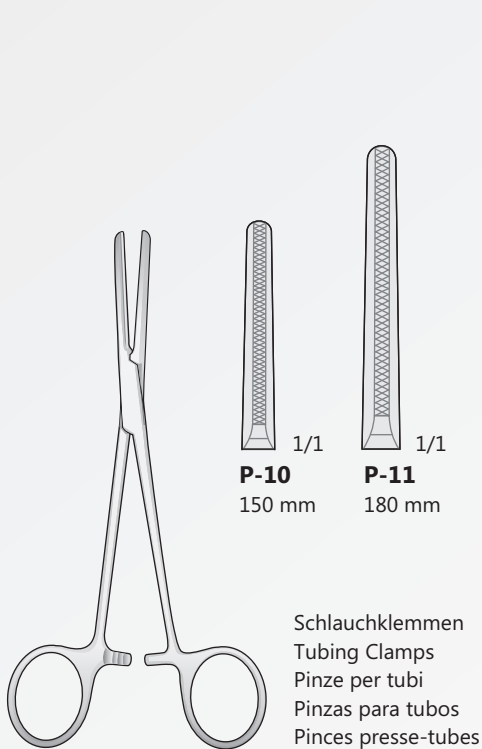

P-10
150 mm

P-11
180 mm

Schlauchklemmen
Tubing Clamps
Pinze per tubi
Pinzas para tubos
Pincas presse-tubes

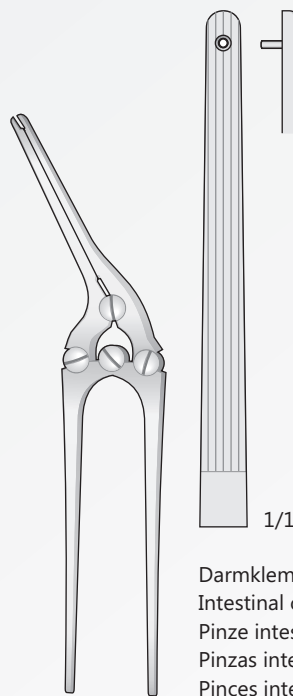

PAYR
EA-20
200 mm

Darmklemmen Elastisch
Intestinal clamps soft elastic
Pinze intestinali elastiche
Pinzas intestinales
Pincas intestinales

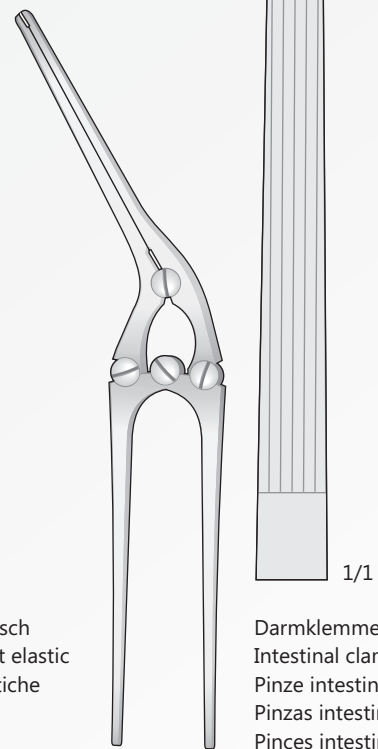

PAYR
EA-21
280 mm

Darmklemmen Elastisch
Intestinal clamps soft elastic
Pinze intestinali elastiche
Pinzas intestinales
Pincas intestinales

P-10/P-11

Atraumatiche Gefäßklemmen
Atraumatic vessel clamps
Pinze atraumatiche
Pinzas vasculares atraumáticas
Pincas vasculaires atrauma

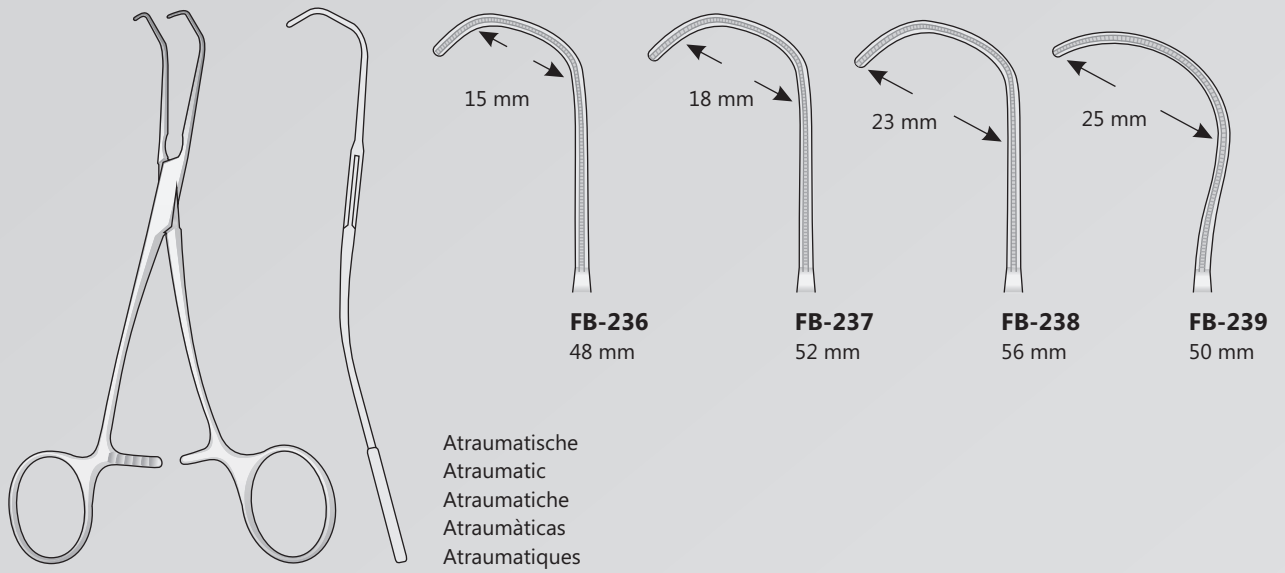

CASTANEDA
FB-236/FB-239
155 mm

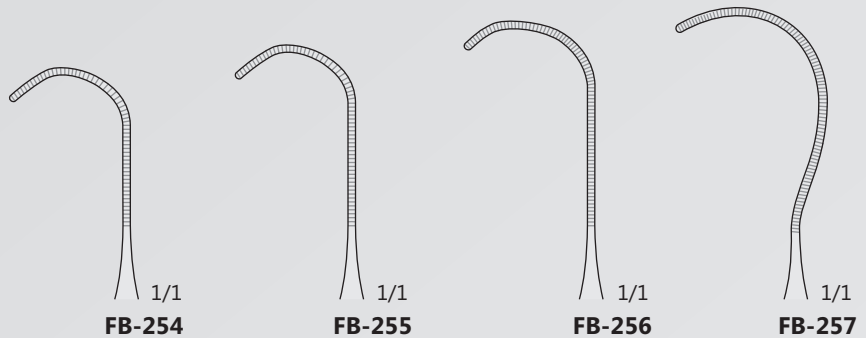
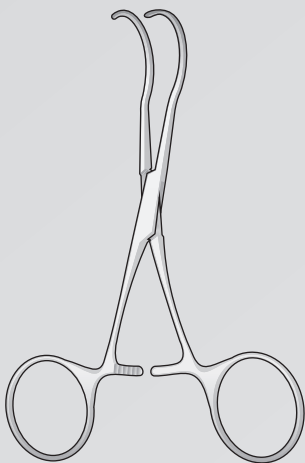
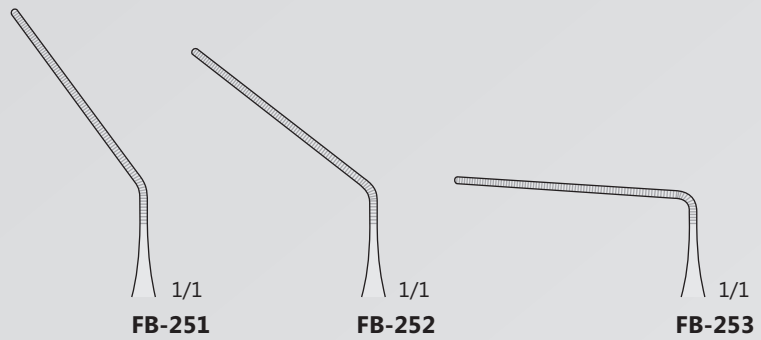

CASTANEDA
FB-251/FD-257
120 mm

Gefäßklemmen
Vessel clamps
Pinze vascolari
Pinzas vasculares
Pincas hémostatiques



Atraumatiche Gefäßklemmen
Atraumatic vessel clamps
Pinze vascolari atraumatiche
Pinzas vasculares atraumáticas
Pincas hémostatiques atraumatiques

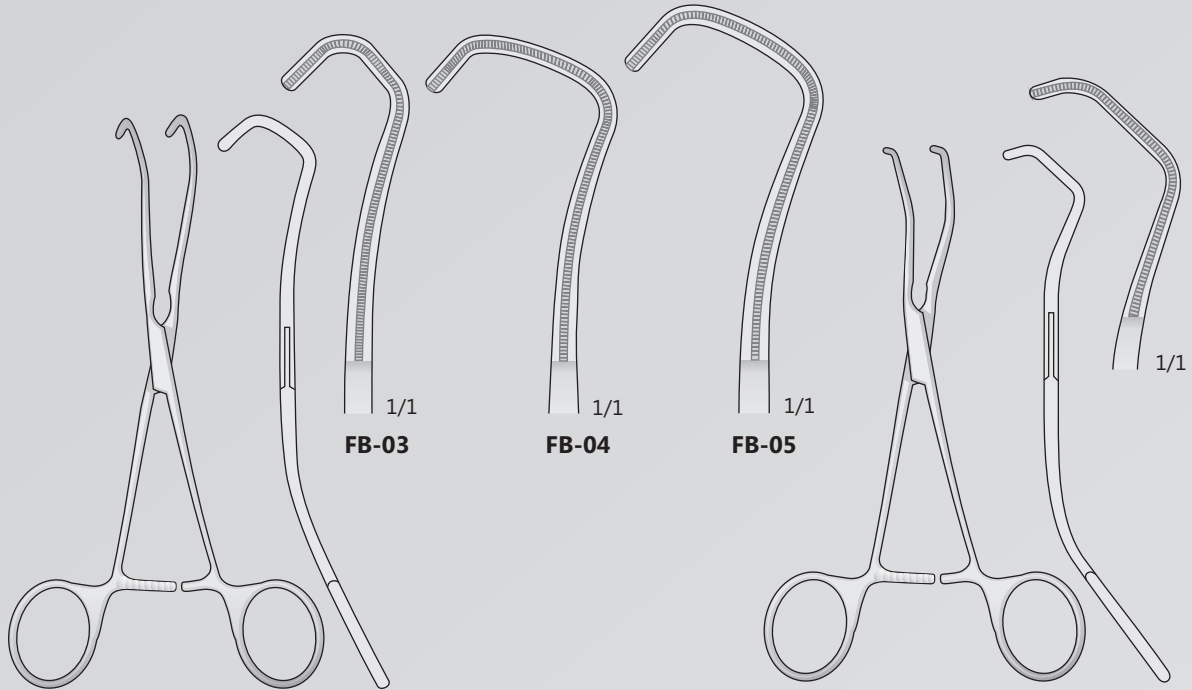

DERRA
FB-03/FB-04
170 mm



COOLEY
FB-16
160 mm

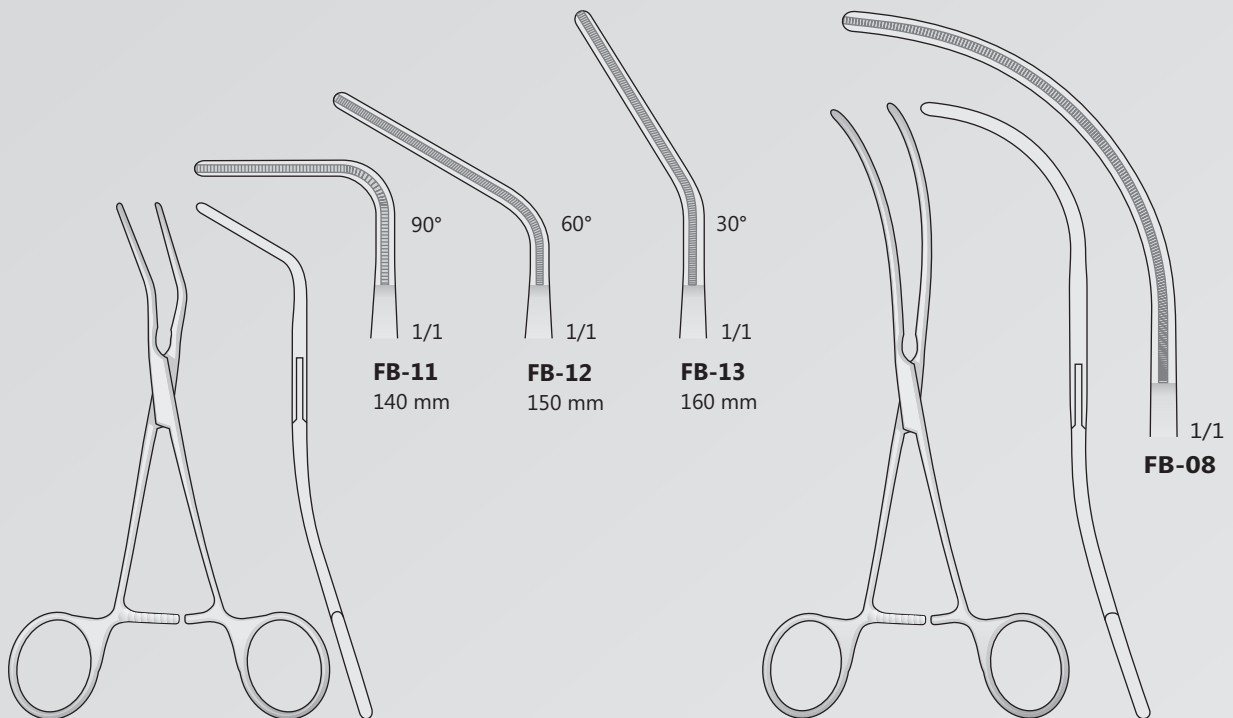

COOLEY
FB-11/FB-13



DE BAKEY
FB-08
180 mm

Atraumatische Gefäßklemmen
Atraumatic vessel clamps
Pinze vascolari atraumatiche
Pinzas vasculares atraumáticas
Pincas hémostatiques atraumatiques

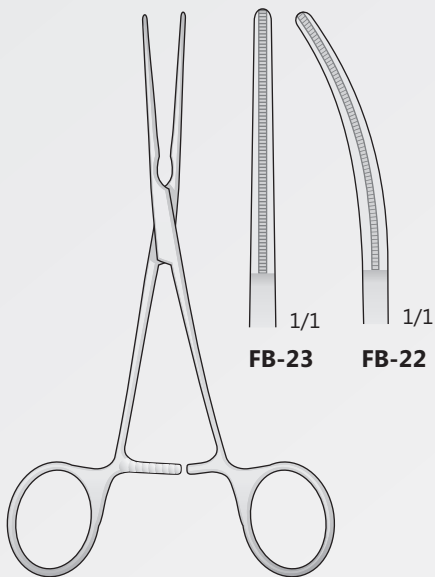

De BAKEY
FB-22/FB-23
165 mm

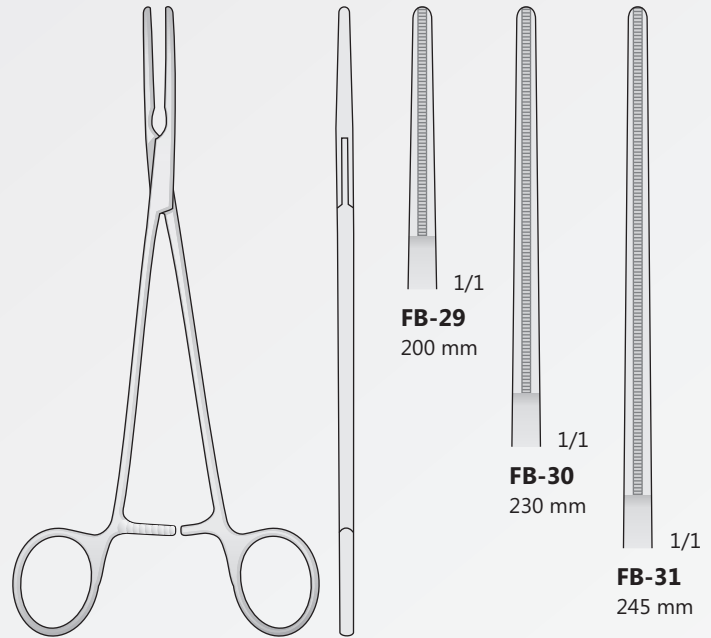

De BAKEY
FB-29/FB-31

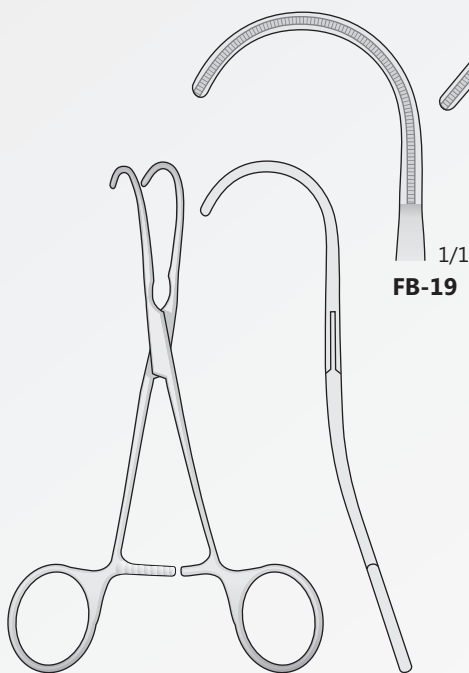

De BAKEY
FB-19/FB-20
150 mm

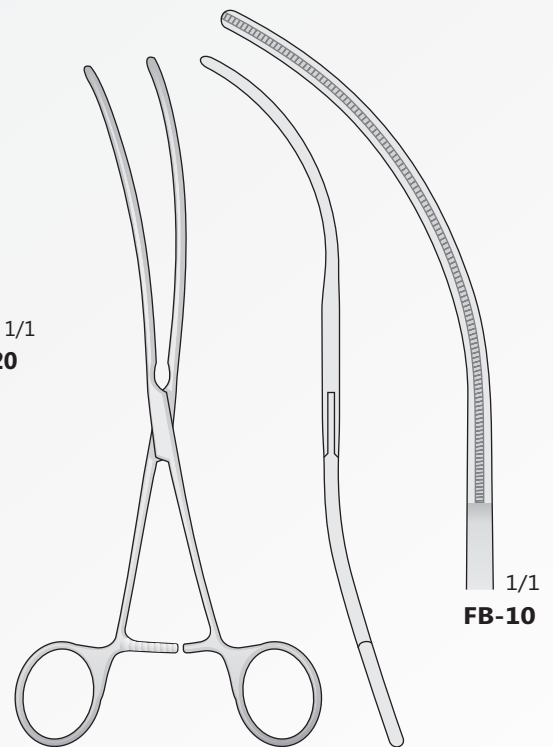

De BAKEY
FB-10
200 mm

Atraumatische Gefäßklemmen
Atraumatic vessel clamps
Pinze vascolari atraumatiche
Pinzas vasculares atraumáticas
Pincas hémostatiques atraumatiques

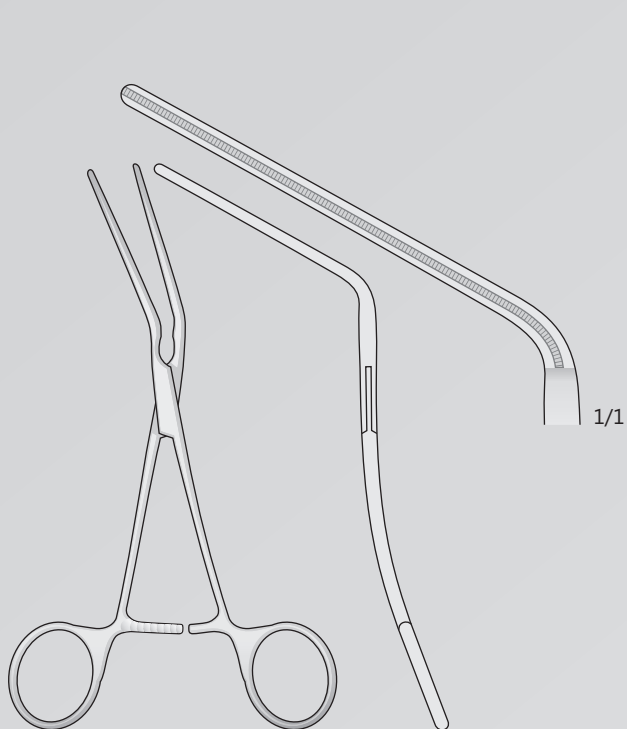

De BAKEY
FB-21
165 mm

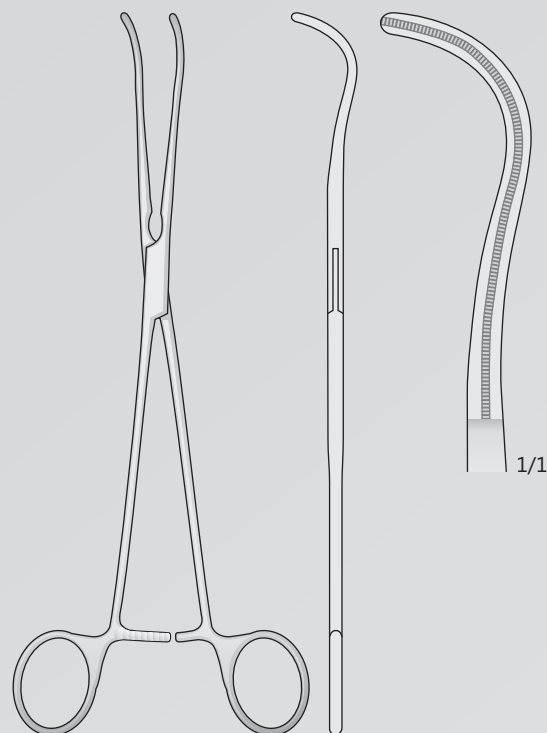

De BAKEY
FB-37
230 mm

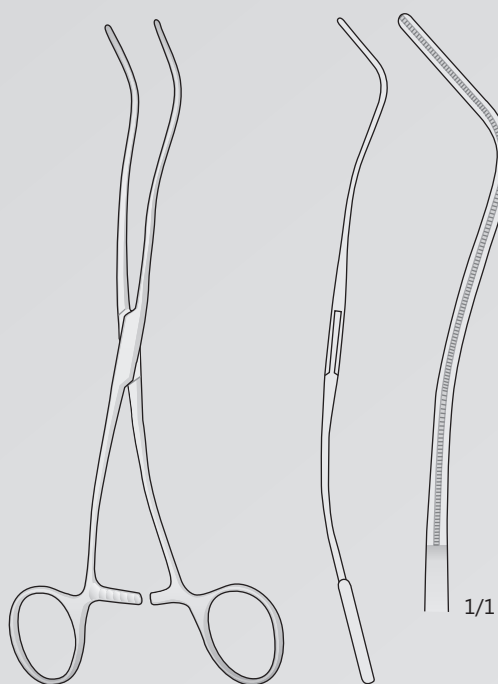

De BAKEY
FB-17
200 mm

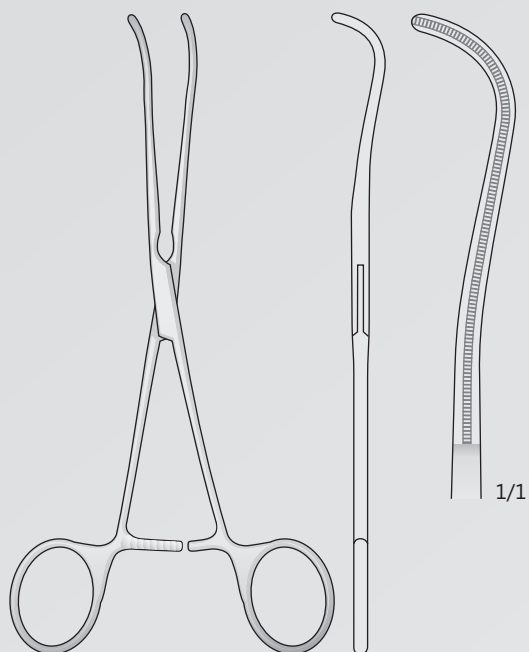

De BAKEY
FB-18
190 mm

Gewebe und organ Fasszangen
 Gum and tissue forceps
 Pinze per afferrare i tessuti
 Pinzas para coger las encias
 Pincas pour saisir les tissue

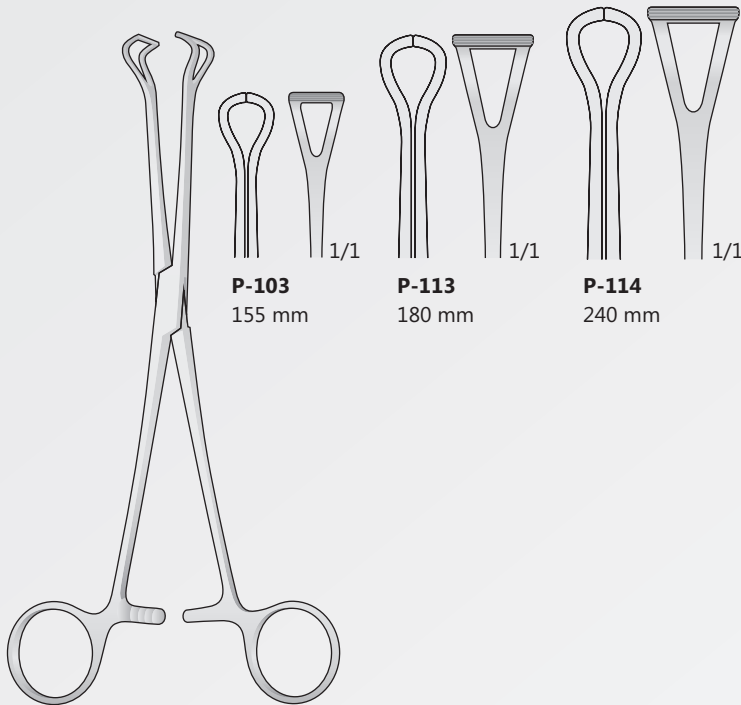

P-103
155 mm

P-113
180 mm

P-114
240 mm

BABCOCK
P-103/P-114

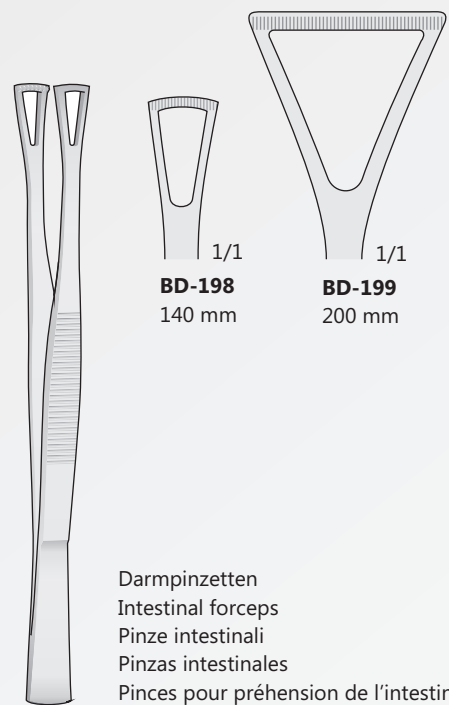

BD-198
140 mm

BD-199
200 mm

Darmpinzetten
 Intestinal forceps
 Pinze intestinali
 Pinzas intestinales
 Pincas pour préhension de l'intestin

DUVAL
BD-198/BD-199

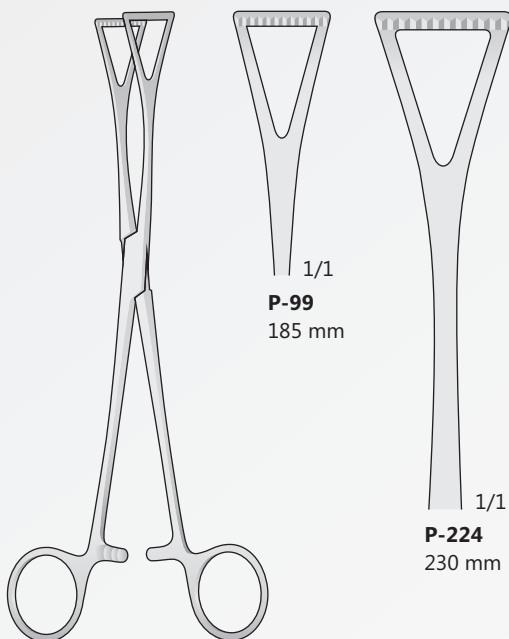

P-99
185 mm

P-224
230 mm

DUVAL
P-99/P-224

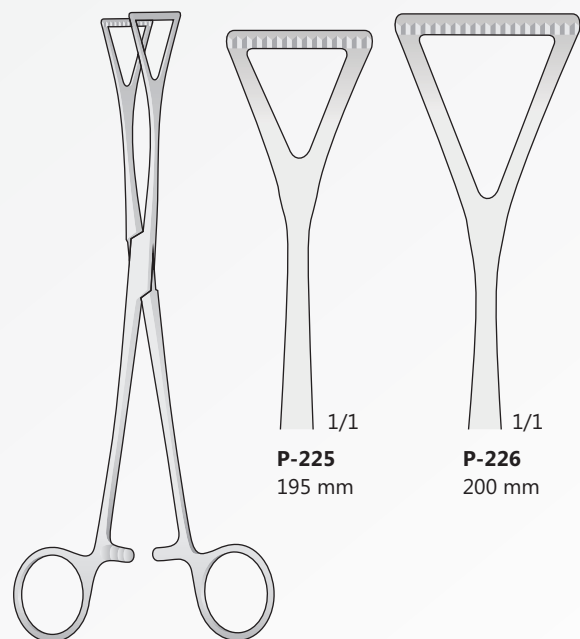

P-225
195 mm

P-226
200 mm

DUVAL-COLLIN
P-225/P-226



BONTEMPI
CHIRURGISCHE INSTRUMENTE

Nahtinstrumente
Suture Instruments
Strumenti per sutura
Instrumentos para sutura
Instruments à suture

Unterbindungsnadeln
Ligature needles
Aghi per legature
Agujas para ligaduras
Aiguilles à ligatures

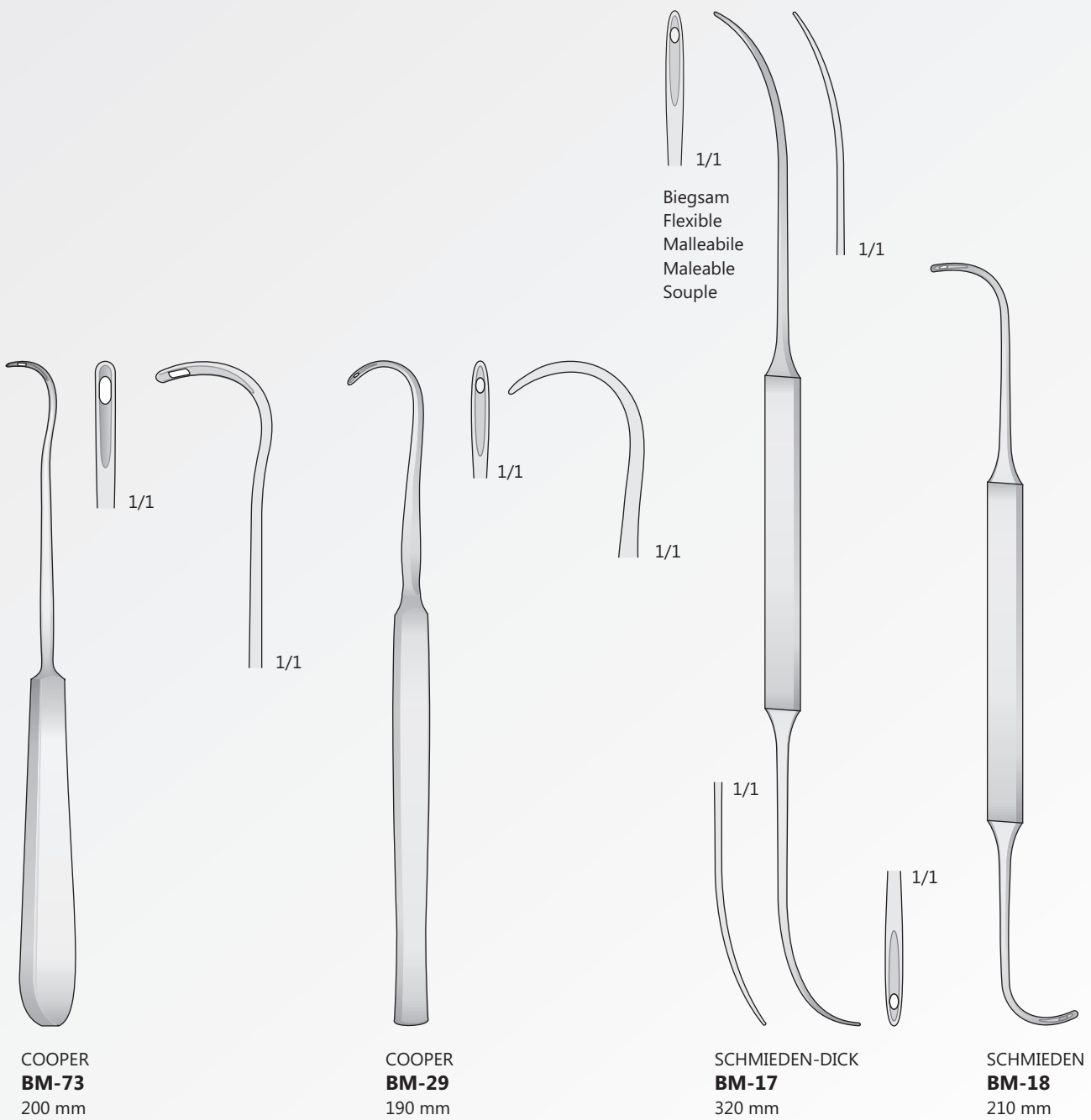

Unterbindungsnadeln
Ligature needles
Aghi per legature
Agujas para ligaduras
Aiguilles à ligatures

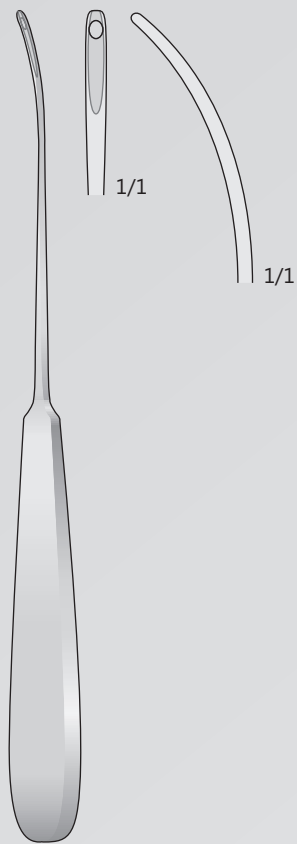

BM-28
200 mm

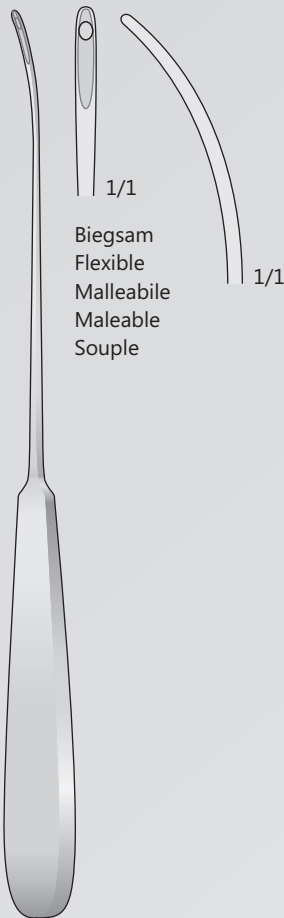

BM-74
230 mm

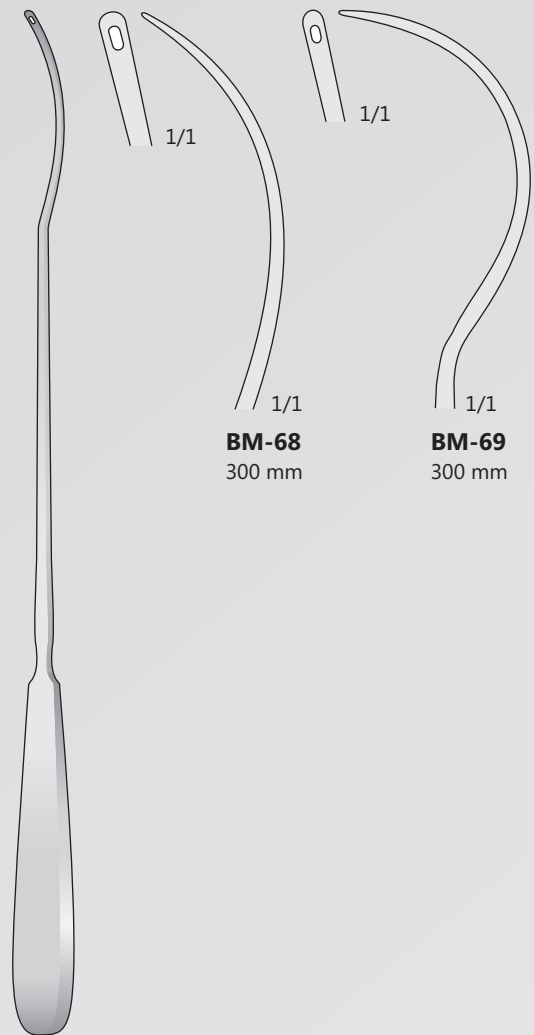

BRUNNER
BM-68/BM-69
300 mm

BM-68
300 mm

BM-69
300 mm

Unterbindungsnadeln
Ligature needles
Aghi per legature
Agujas para ligaduras
Aiguilles à ligatures

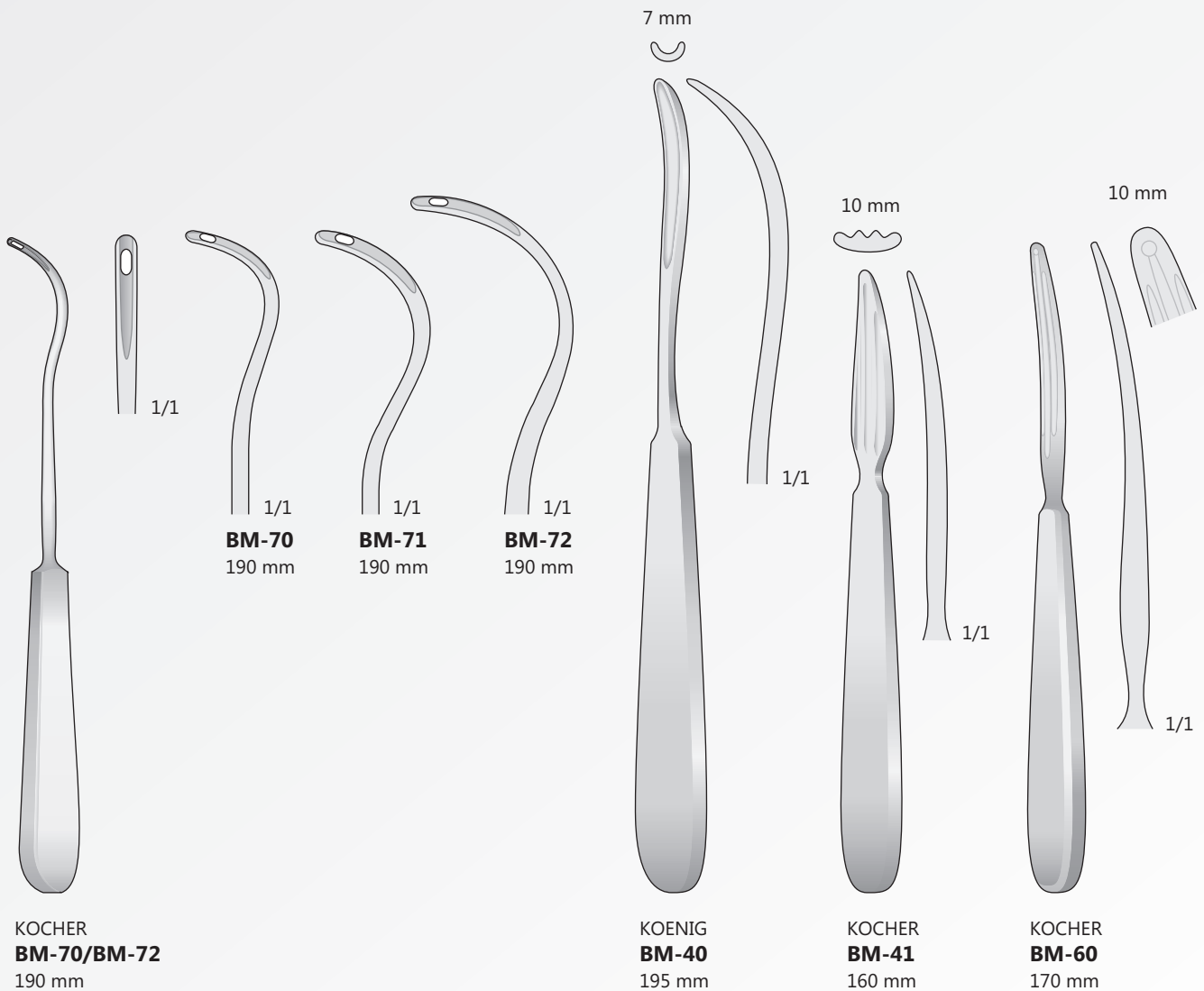

Unterbindungsadeln
Ligature needles
Aghi per legature
Agujas para ligaduras
Aiguilles à ligatures

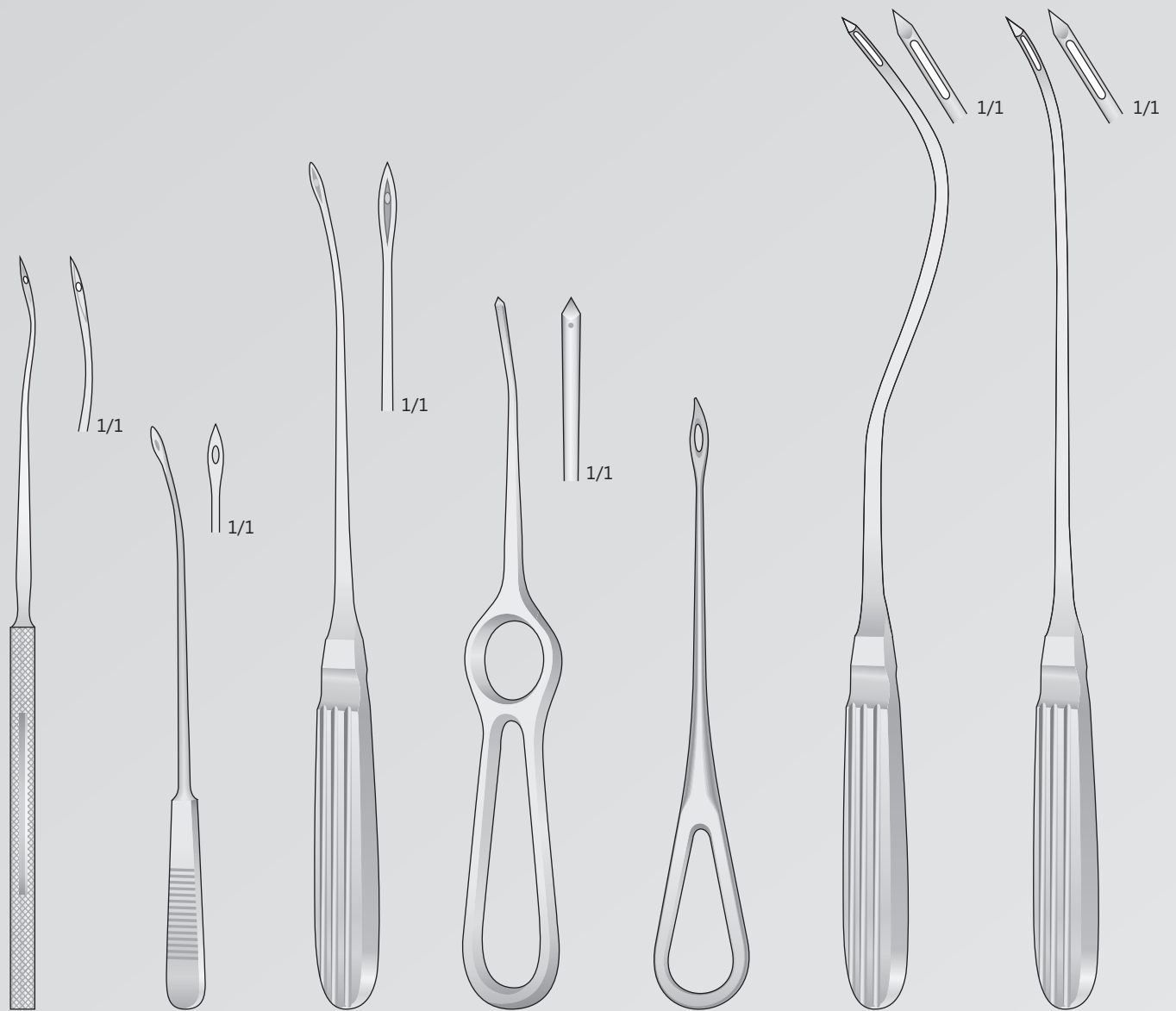

YANKAUER
BM-151
170 mm

OBWEGESER
DO-30
140 mm

OBWEGESER
DO-31
230 mm

DO-32
180 mm

GERLACH
DO-33
150 mm

SANDERS-BROWN
DO-44
290 mm

SANDERS-BROWN
DO-49
300 mm

Unterbindungsnadeln
Ligature needles
Aghi per legature
Agujas para ligaduras
Aiguilles à ligatures

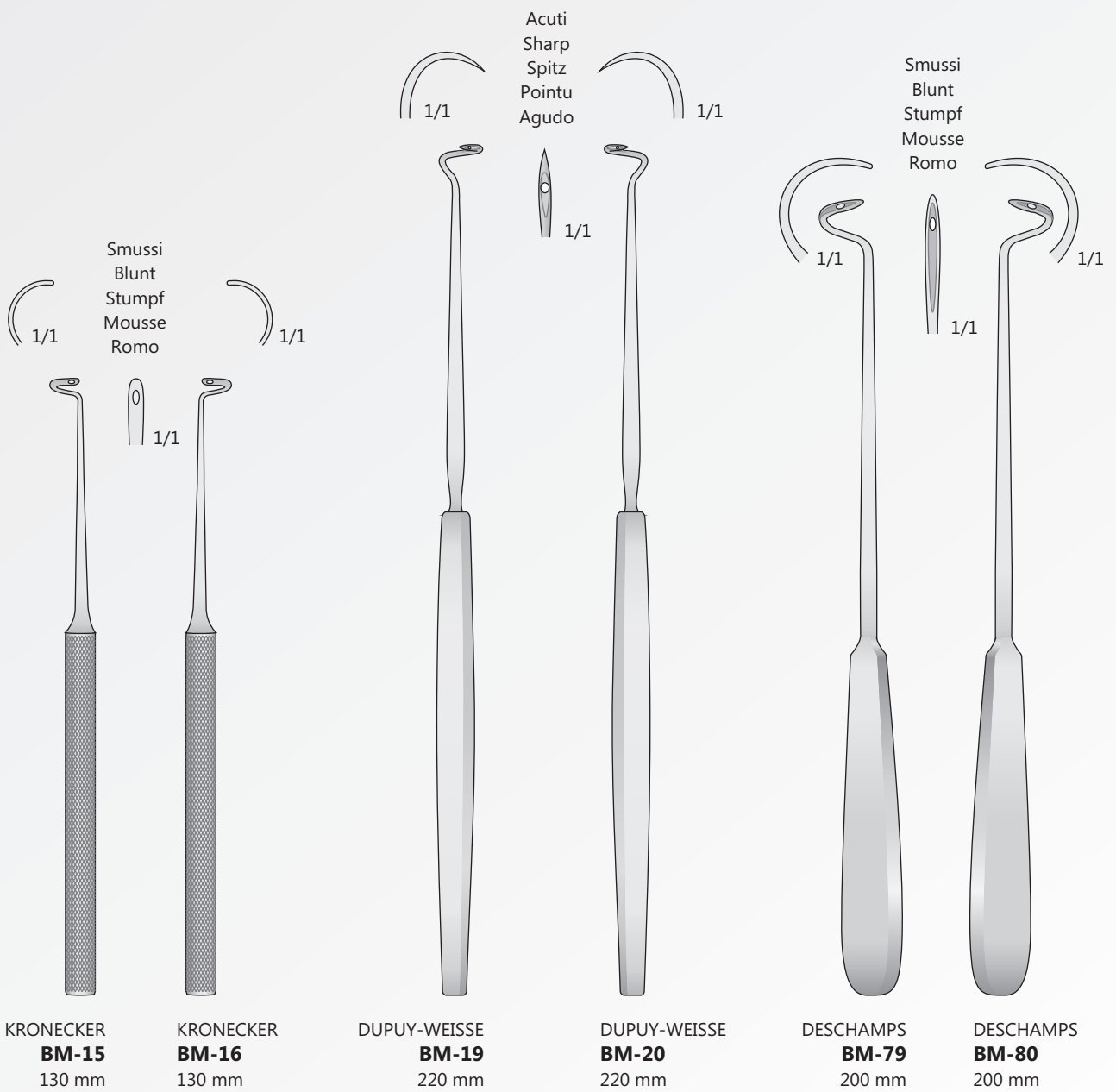

Unterbindungsnadeln
Ligature needles
Aghi per legature
Agujas para ligaduras
Aiguilles à ligatures

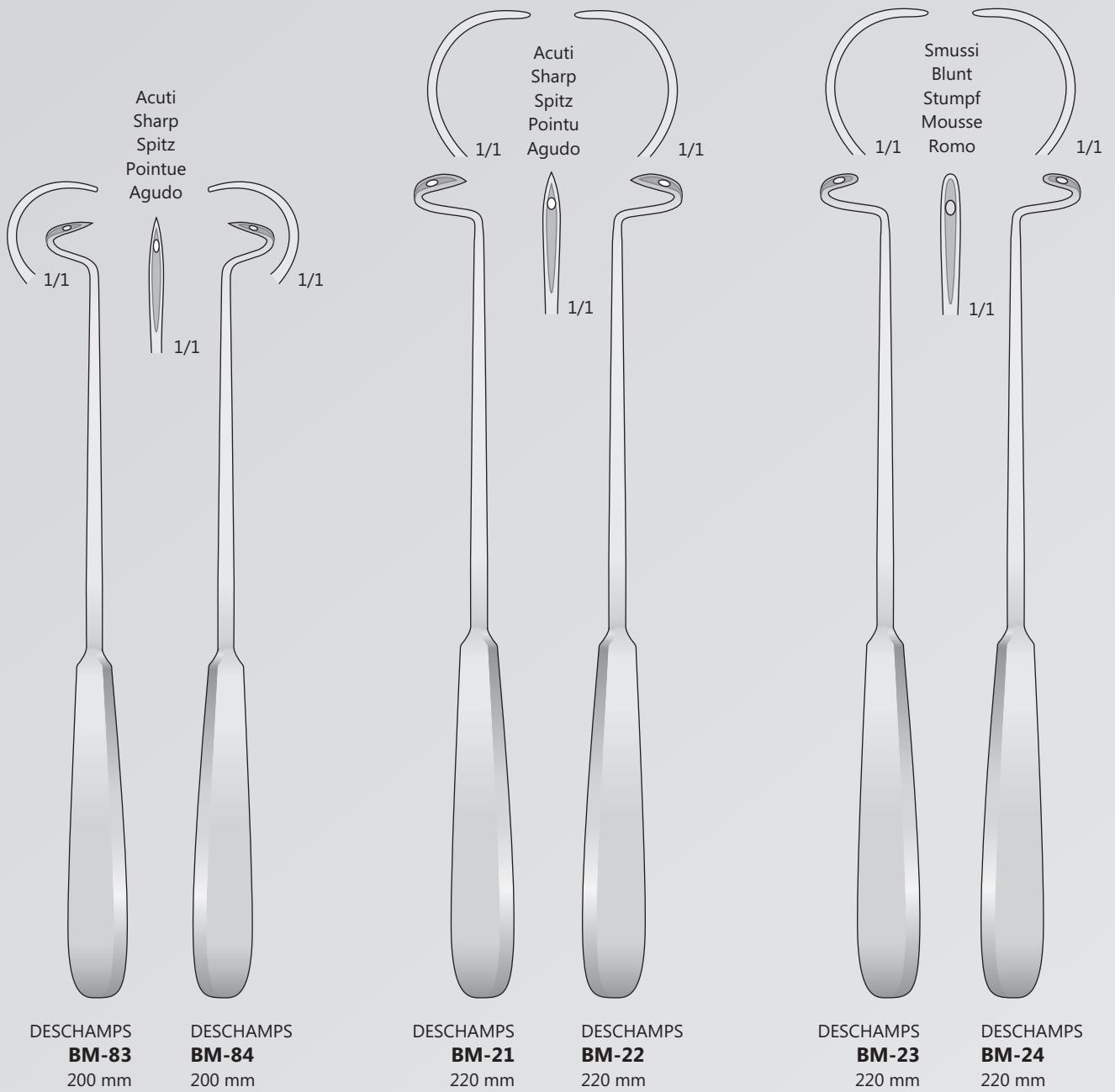

Drahtumföhrungsnadel
Wire guides
Passafilii
Agujas para hilos
Aiguilles passe-fils



DEMEL
BM-12/BM-14

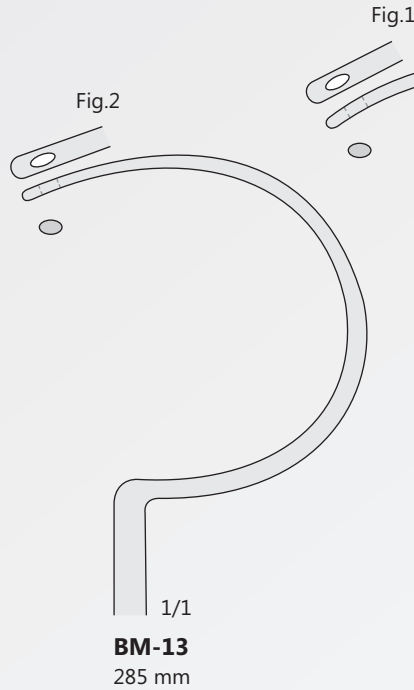
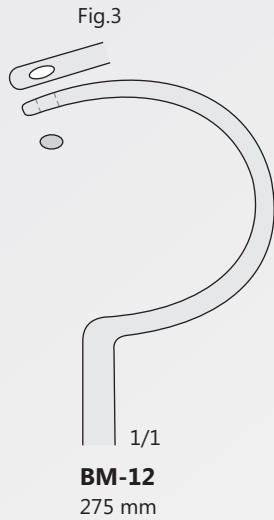

BM-10
225 mm

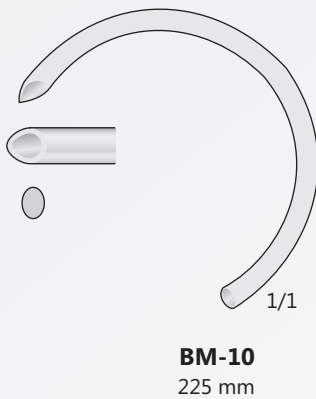

Hohl, Spitz
Hollow, Sharp
Cavo, Acuto
Hueco, Agudo
Creux, Pointu

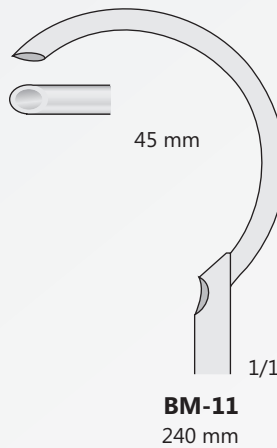

Hohl, Spitz
Hollow, Sharp
Cavo, Acuto
Hueco, Agudo
Creux, Pointu

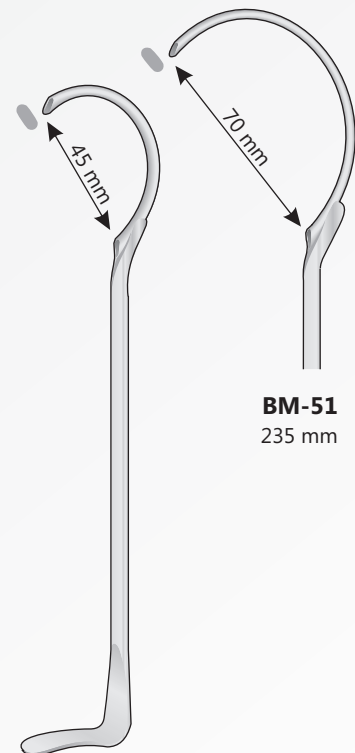

| | |
|-----------------|---|
| Nadelhalter | Nadelhalter mit Hartmetalleinlagen |
| Needle Holders | Needle Holders with tungsten-carbide inserts |
| Port'aghi | Portaghi con inserti al tungsteno |
| Portaagujas | Portaagujas con plaquitas de carburo de tungsteno |
| Porte aiguilles | Porte aiguilles avec plaquettes en carbure de tungstène |

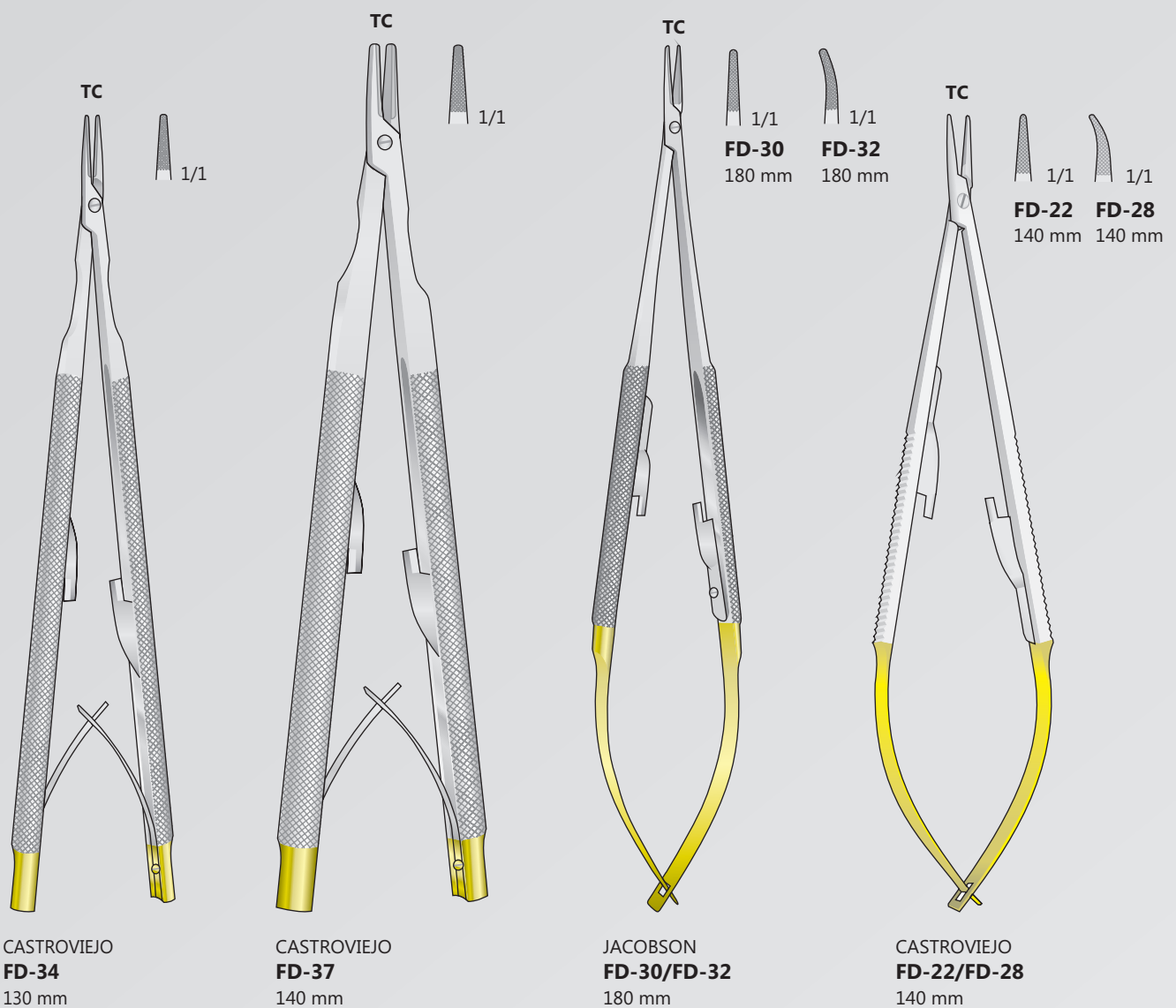

Nadelhalter mit Hartmetalleinlagen
Needle Holders with tungsten-carbide inserts
Portaghi con inserti al tungsteno
Portaagujas con plaquitas de carburo de tungsteno
Porte aiguilles avec plaquettes en carbure de tungstène

Nadelhalter
Needle Holders
Port'aghi
Portaagujas
Porte aiguilles

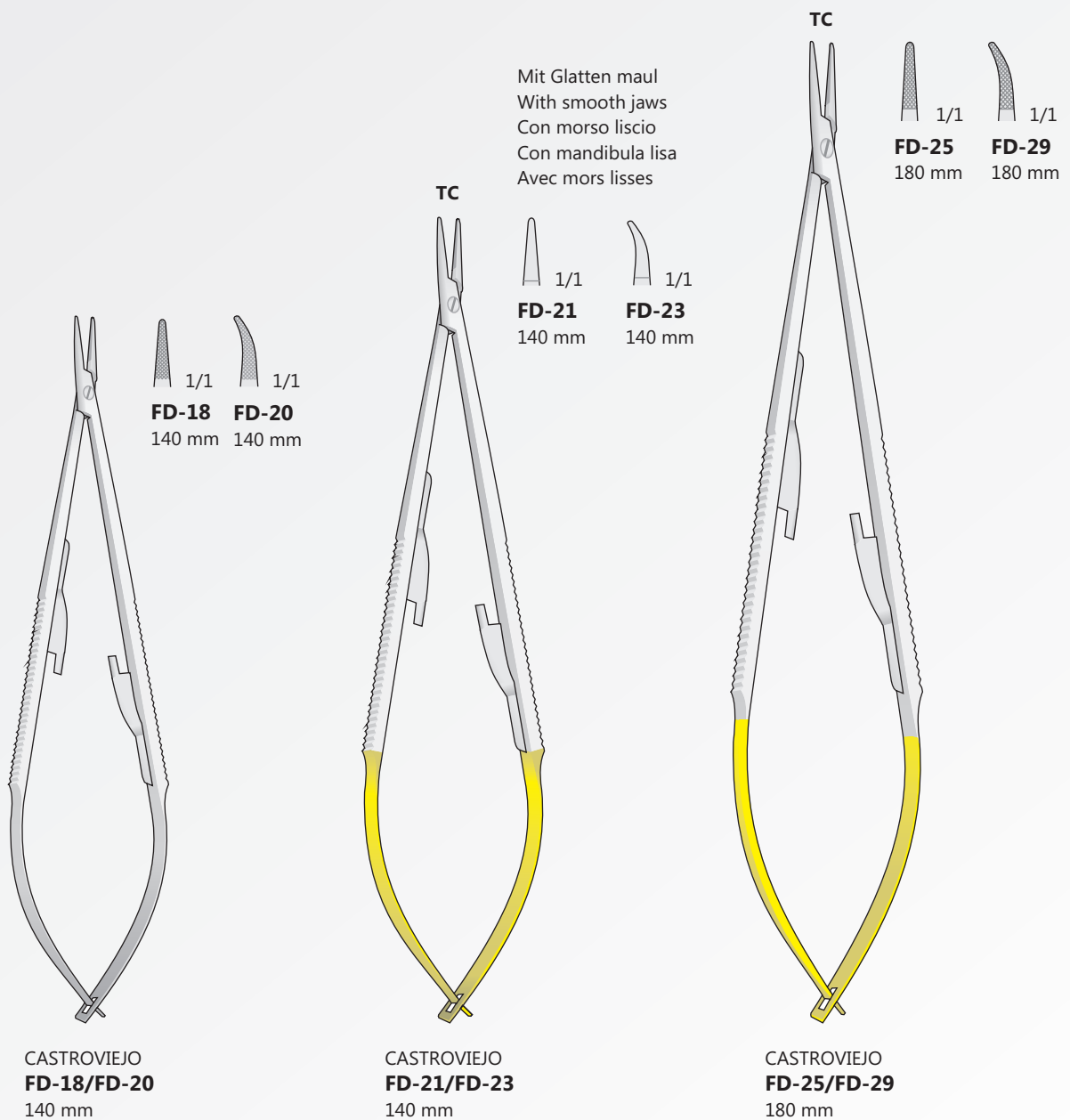

| | |
|-----------------|---|
| Nadelhalter | Nadelhalter mit Hartmetalleinlagen |
| Needle Holders | Needle Holders with tungsten-carbide inserts |
| Port'aghi | Portaghi con inserti al tungsteno |
| Portaagujas | Portaagujas con plaquitas de carburo de tungsteno |
| Porte aiguilles | Porte aiguilles avec plaquettes en carbure de tungstène |

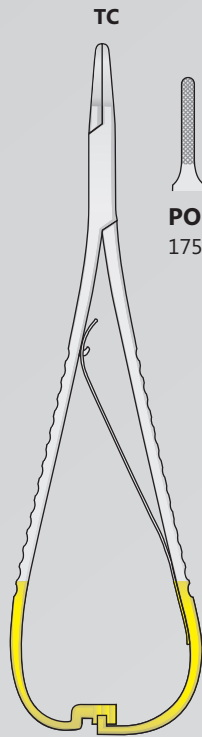

LICHTENBERG
PO-86/PO-96

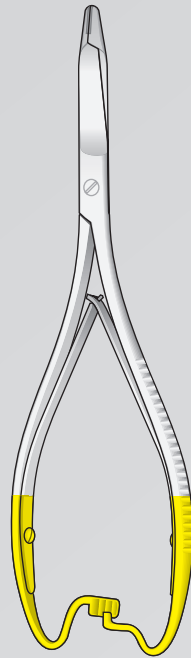
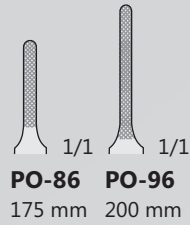

OLSEN-MATHIEU
PO-95/PO-100



PO-95
140 mm

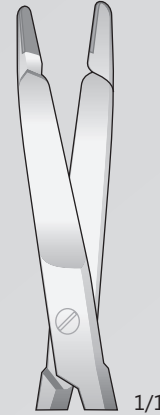

PO-98
170 mm

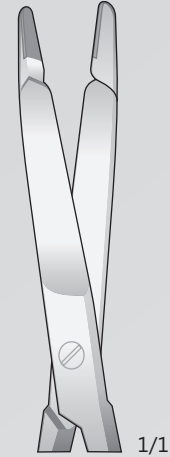

PO-100
200 mm

Mit Schere
With Scissors
Con Forbice
Con Tijeras
Avec Ciseaux

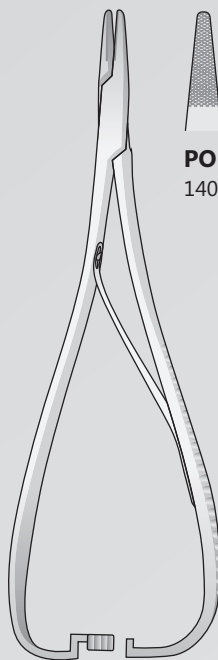

MATHIEU
PO-46/PO-48

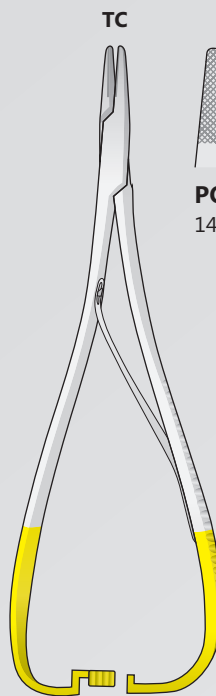
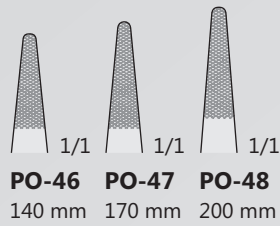

MATHIEU
PO-50/PO-52

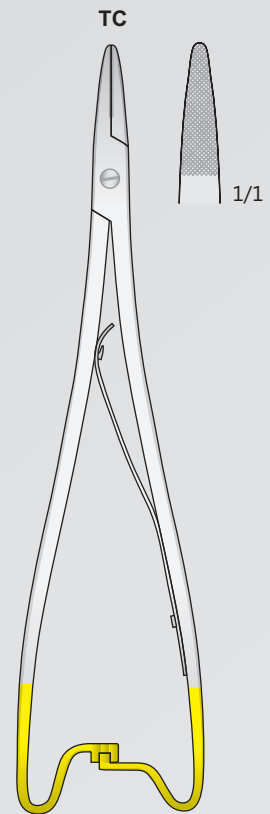
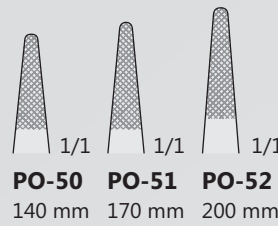

MATHIEU
PO-66
200 mm

Nadelhalter mit Hartmetalleinlagen
Needle Holders with tungsten-carbide inserts
Portaghi con inserti al tungsteno
Portaagujas con plaquitas de carburo de tungsteno
Porte aiguilles avec plaquettes en carbure de tungstène

Nadelhalter
Needle Holders
Port'aghi
Portaagujas
Porte aiguilles

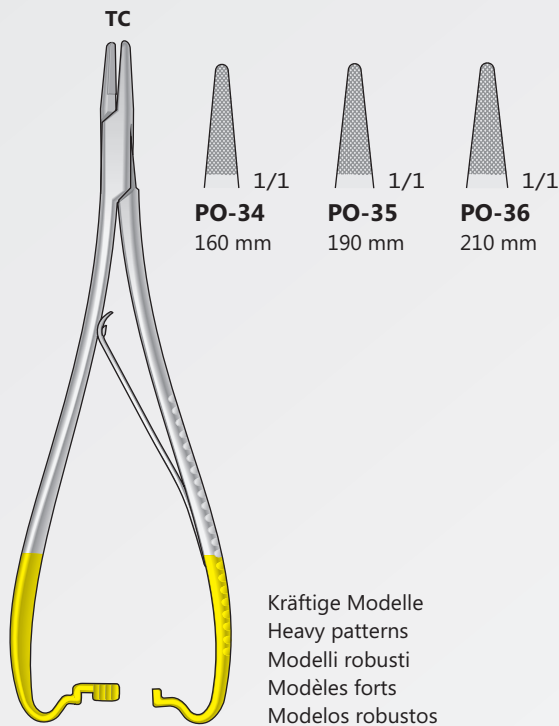

MATHIEU
PO-34/PO-36

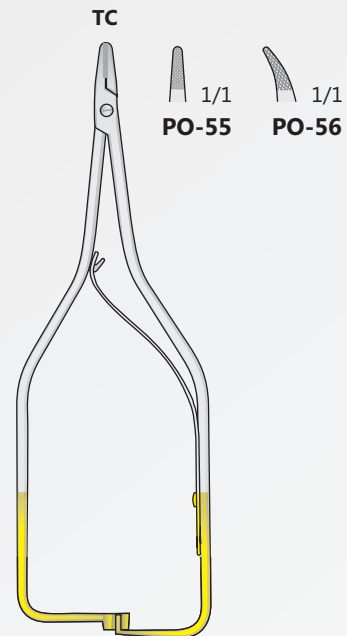

BOYNTON
PO-55/PO-56
120 mm

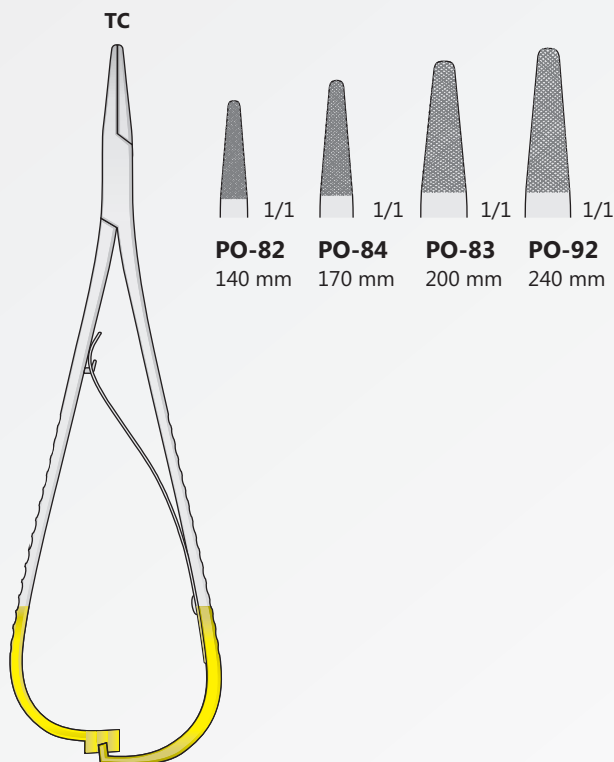

MATHIEU
PO-82/PO-92

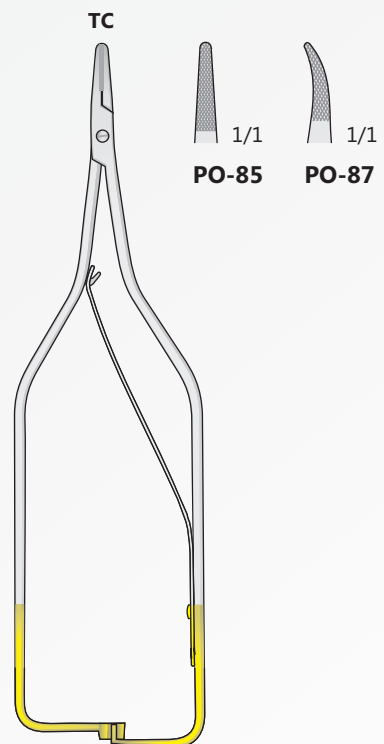

ARRUGA
PO-85/PO-87
160 mm

| | |
|-----------------|---|
| Nadelhalter | Nadelhalter mit Hartmetalleinlagen |
| Needle Holders | Needle Holders with tungsten-carbide inserts |
| Port'aghi | Portaghi con inserti al tungsteno |
| Portaagujas | Portaagujas con plaquitas de carburo de tungsteno |
| Porte aiguilles | Porte aiguilles avec plaquettes en carbure de tungstène |

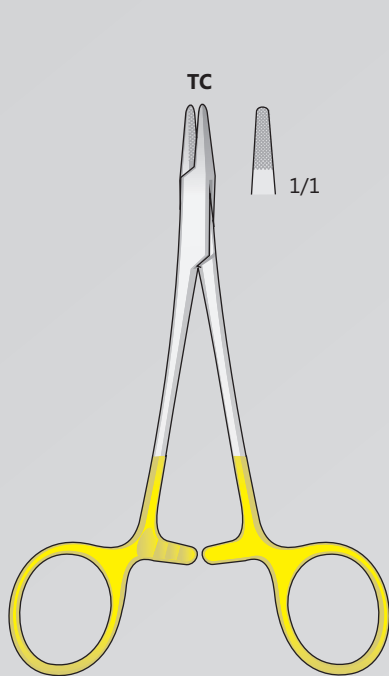

DERF
PH-69
115 mm

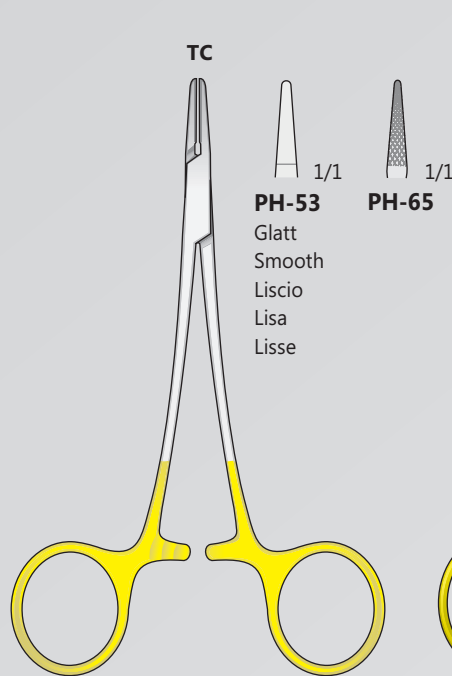

PH-53/PH-65
120 mm

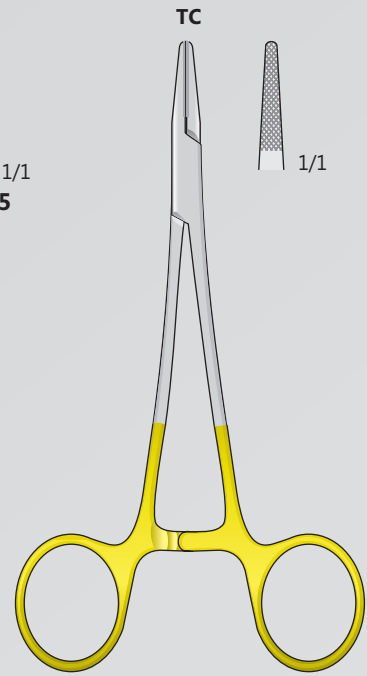

CONVERSE
PH-68
130 mm

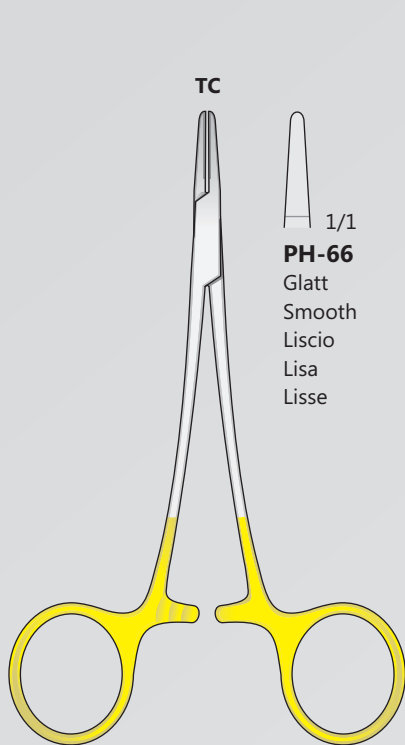

WEBSTER
PH-66
130 mm

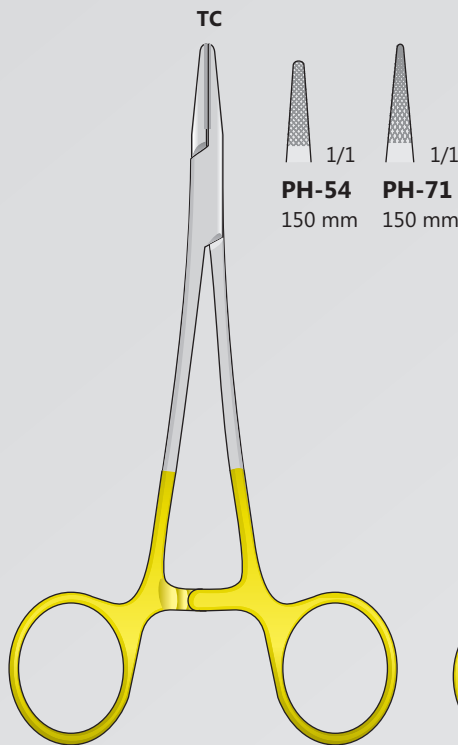

CRILE-WOOD
PH-54/PH-71
150 mm

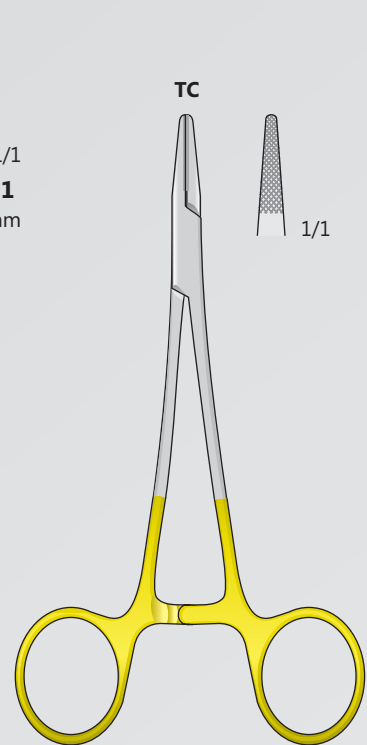

HALSEY
PH-73
130 mm

Nadelhalter mit Hartmetalleinlagen
Needle Holders with tungsten-carbide inserts
Portaghi con inserti al tungsteno
Portaagujas con plaquitas de carburo de tungsteno
Porte aiguilles avec plaquettes en carbure de tungstène

Nadelhalter
Needle Holders
Port'aghi
Portaagujas
Porte aiguilles

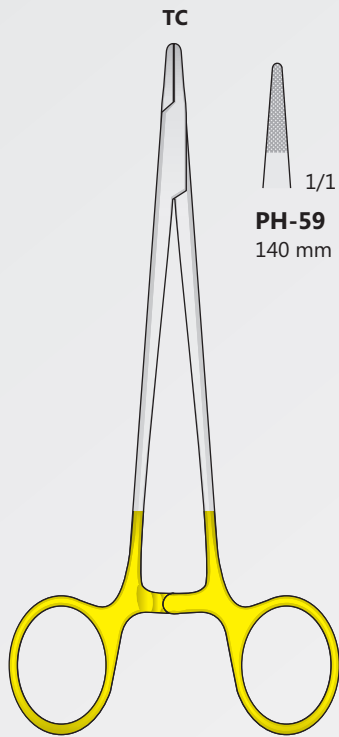

HEGAR
PH-59/PH-76

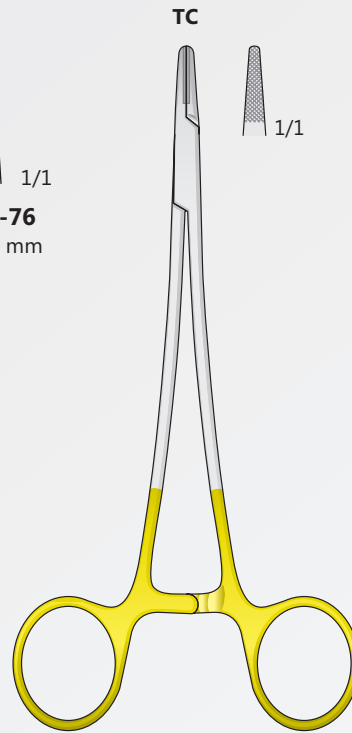
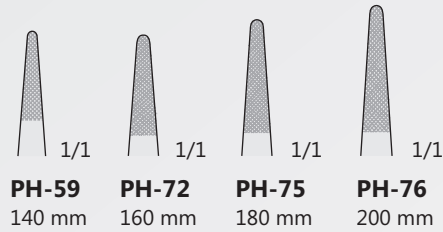

PH-79
145 mm

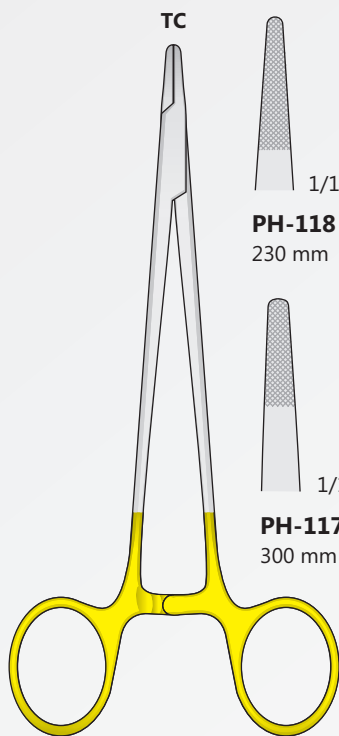
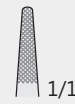

MAYO-HEGAR
PH-117/PH-119

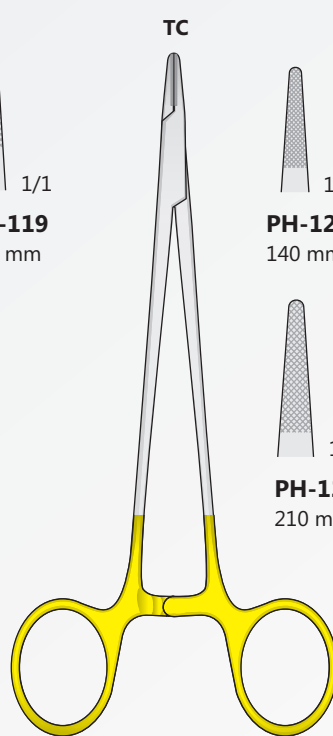
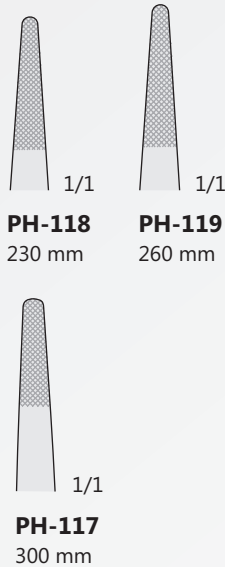

MAYO-HEGAR
PH-120/PH-125

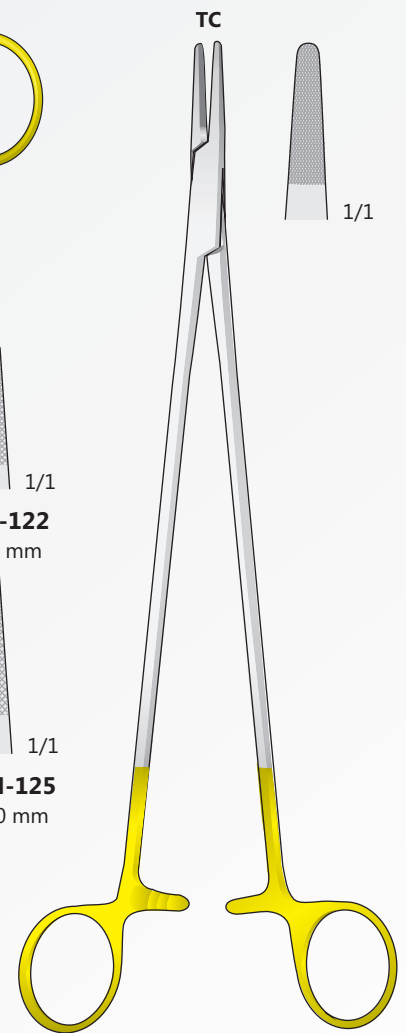
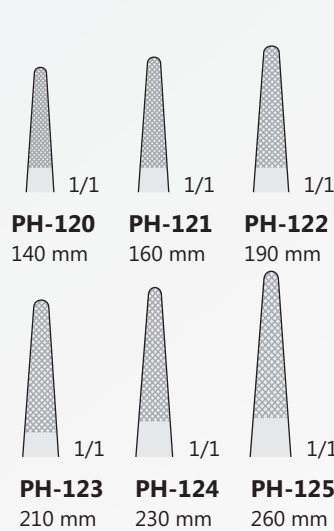

HEGAR
PH-115
205 mm

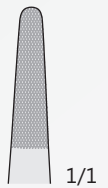

| | |
|-----------------|---|
| Nadelhalter | Nadelhalter mit Hartmetalleinlagen |
| Needle Holders | Needle Holders with tungsten-carbide inserts |
| Port'aghi | Portaghi con inserti al tungsteno |
| Portaagujas | Portaagujas con plaquitas de carburo de tungsteno |
| Porte aiguilles | Porte aiguilles avec plaquettes en carbure de tungstène |

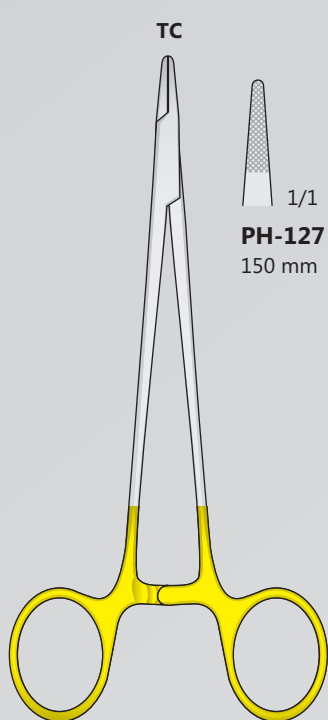

MAYO-HEGAR-FINO
PH-127/PH-129

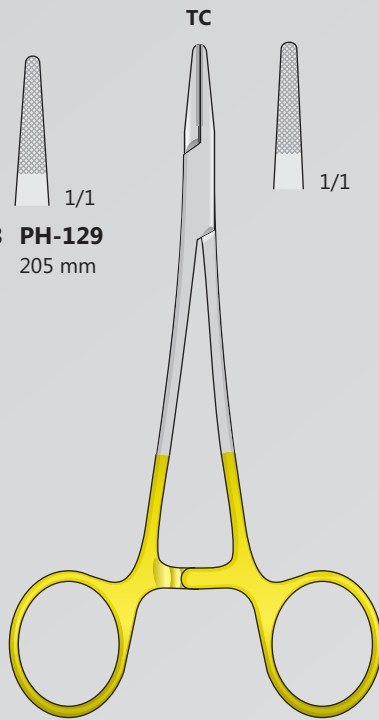

CRILE-WOOD
PH-77
180 mm

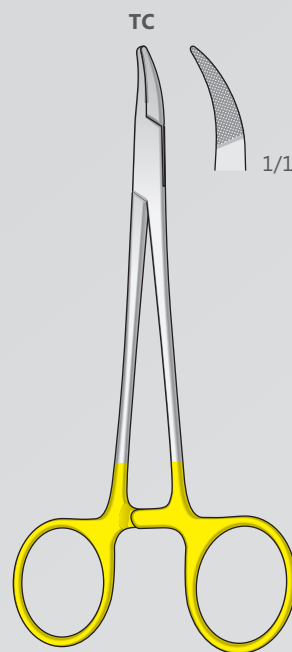

CRILE-WOOD
PH-90
150 mm

Nadelhalter, Draht-Zangen
Needle holder, wire forceps
Port'aghi, pinze per fili d'acciaio
Porta agujas, pinzas para hilos
Porte-aiguilles, pincès à saisir

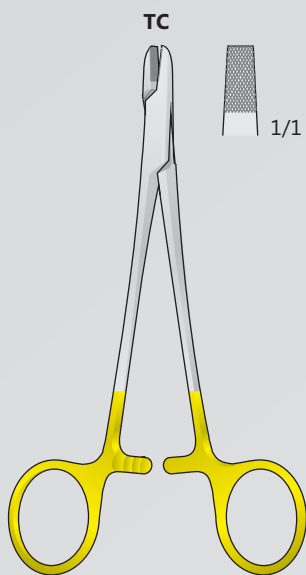

PH-58
150 mm

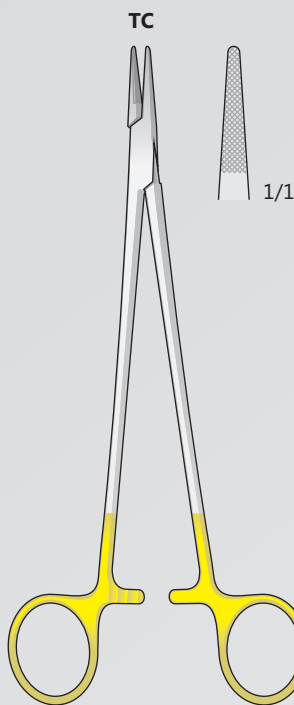

HEGAR-MAYO-SEELEY
PH-130
200 mm

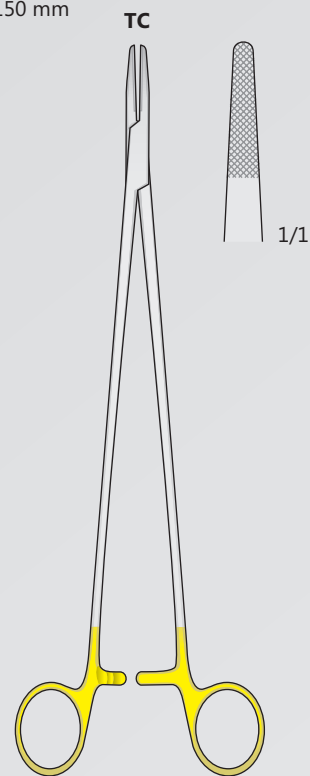

WANGENSTEEN
PH-131
270 mm

Nadelhalter mit Hartmetalleinlagen
Needle Holders with tungsten-carbide inserts
Portaghi con inserti al tungsteno
Portaagujas con plaquitas de carburo de tungsteno
Porte aiguilles avec plaquettes en carbure de tungstène

Nadelhalter
Needle Holders
Port'aghi
Portaagujas
Porte aiguilles

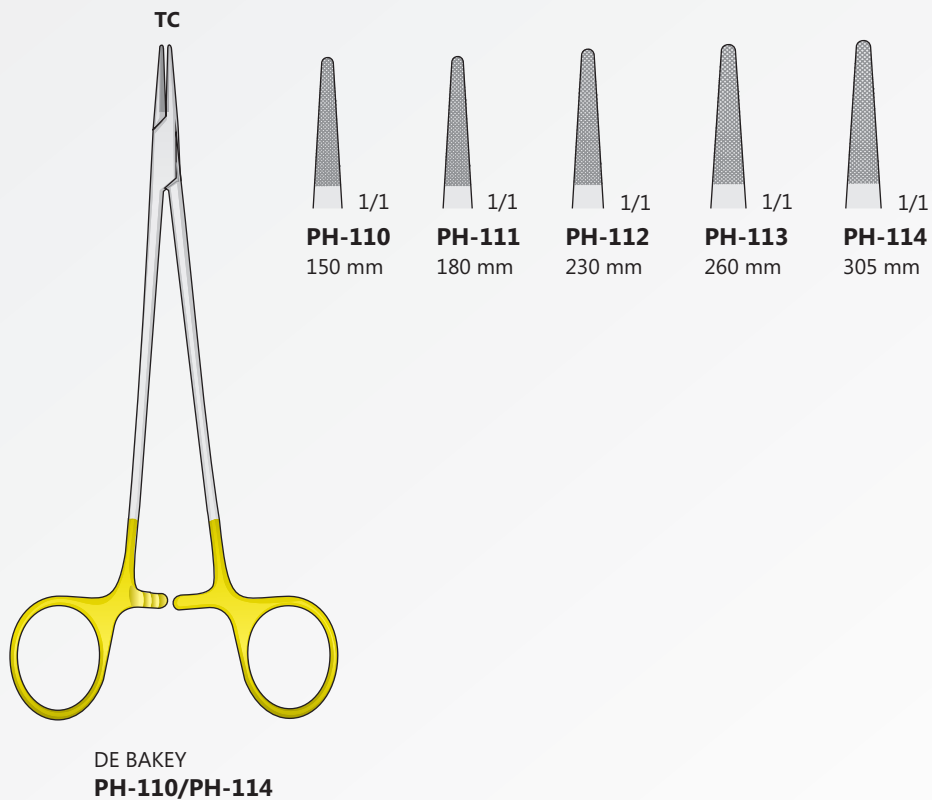
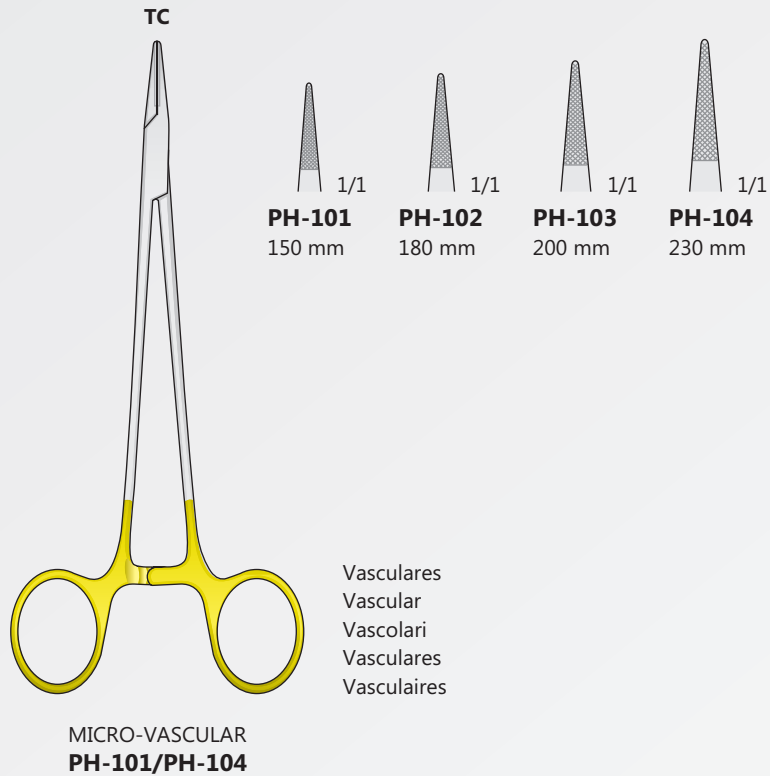

Nadelhalter mit Schere
Needle holders with scissors
Port'aghi con forbici
Portaagujas con tijeras
Porte aiguilles avec ciseaux

Nadelhalter mit Hartmetalleinlagen
Needle Holders with tungsten-carbide inserts
Portaghi con inserti al tungsteno
Portaagujas con plaquitas de carburo de tungsteno
Porte aiguilles avec plaquettes en carbure de tungstène

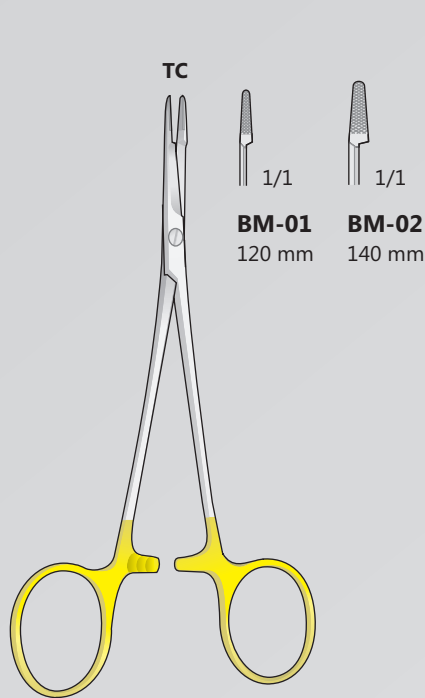

OLSEN-HEGAR
BM-01/BM-02

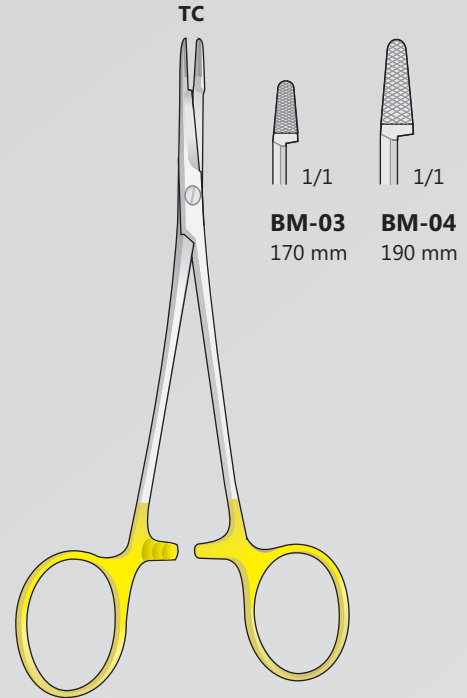

OLSEN-HEGAR
BM-03/BM-04

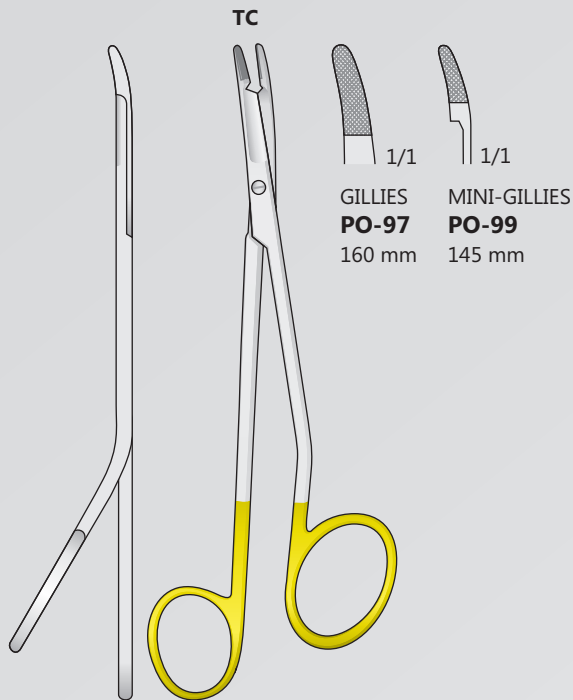

GILLIES
PO-97/PO-99

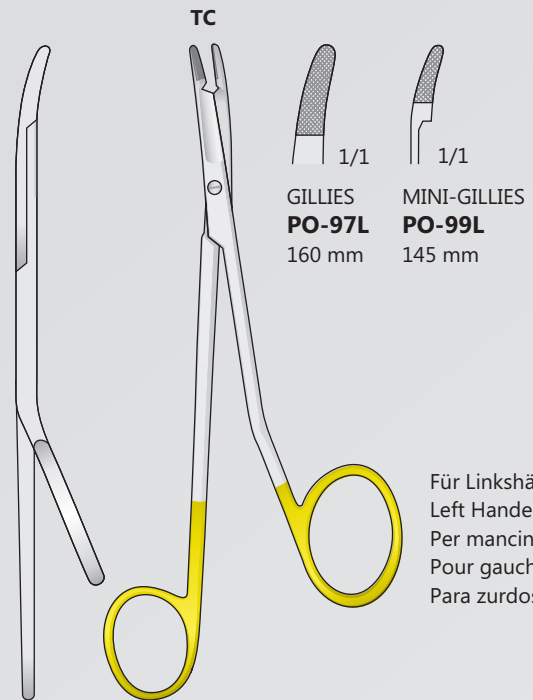

GILLIES
PO-97L/PO-99L

Für Linkshänder
Left Handed
Per mancini
Pour gauche
Para zurdos

Nadelhalter mit Hartmetalleinlagen
Needle Holders with tungsten-carbide inserts
Portaghi con inserti al tungsteno
Portaagujas con plaquitas de carburo de tungsteno
Porte aiguilles avec plaquettes en carbure de tungstène

Nadelhalter
Needle Holders
Port'aghi
Portaagujas
Porte aiguilles

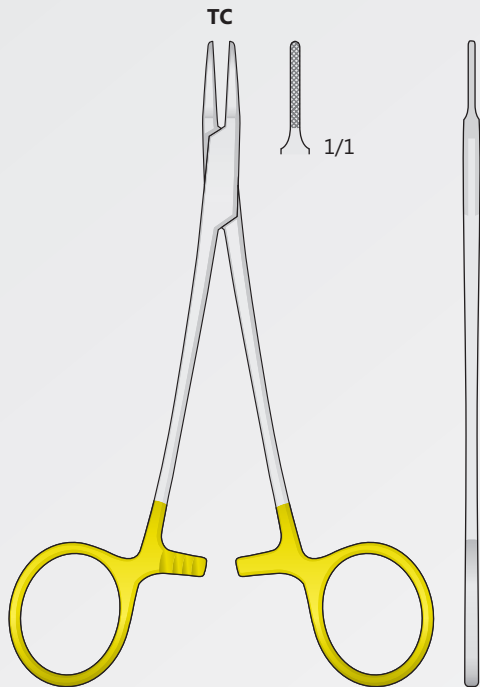

MICRO-RYDER
PH-83
140 mm

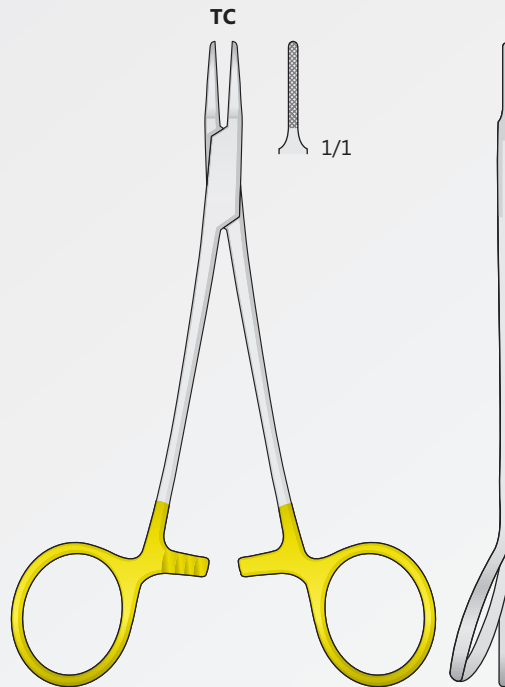

PH-84
140 mm

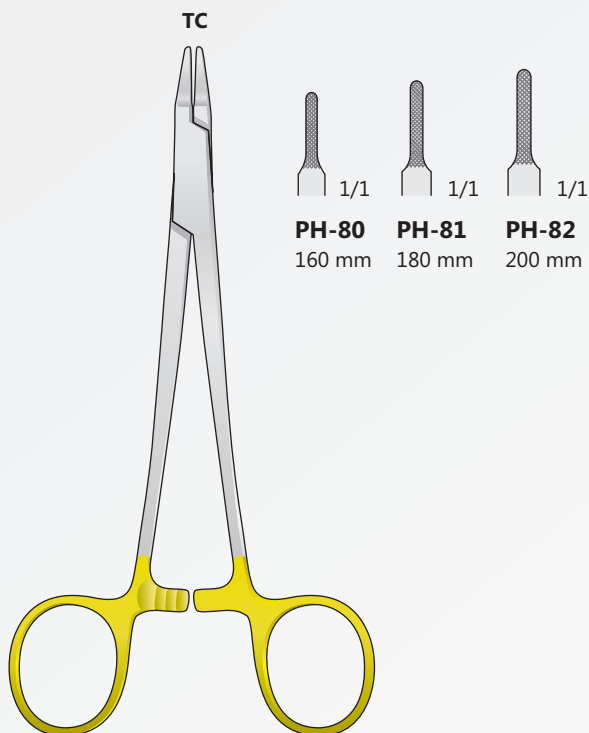

RYDER
PH-80/PH-82

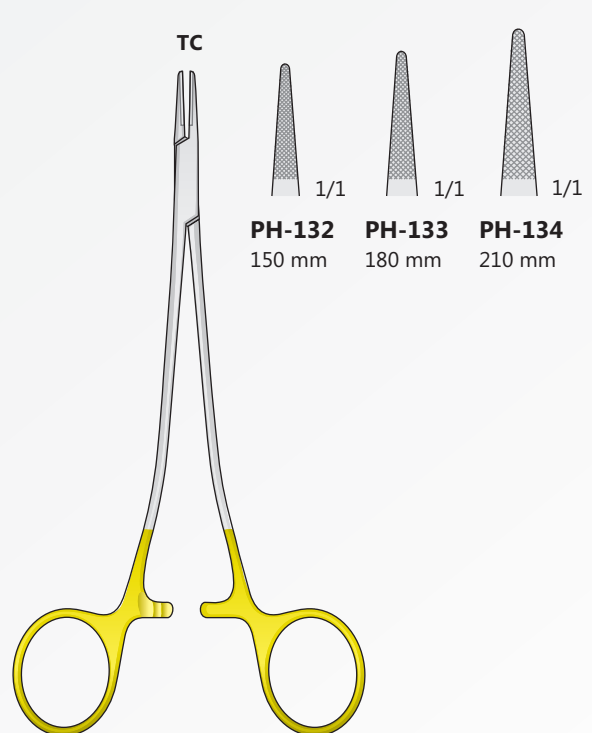

SAROT
PH-132/PH-134

Nadelhalter
Needle Holders
Port'aghi
Portaagujas
Porte aiguilles

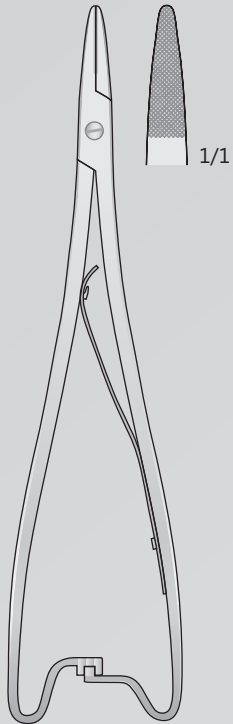

MATHIEU
PO-67
200 mm

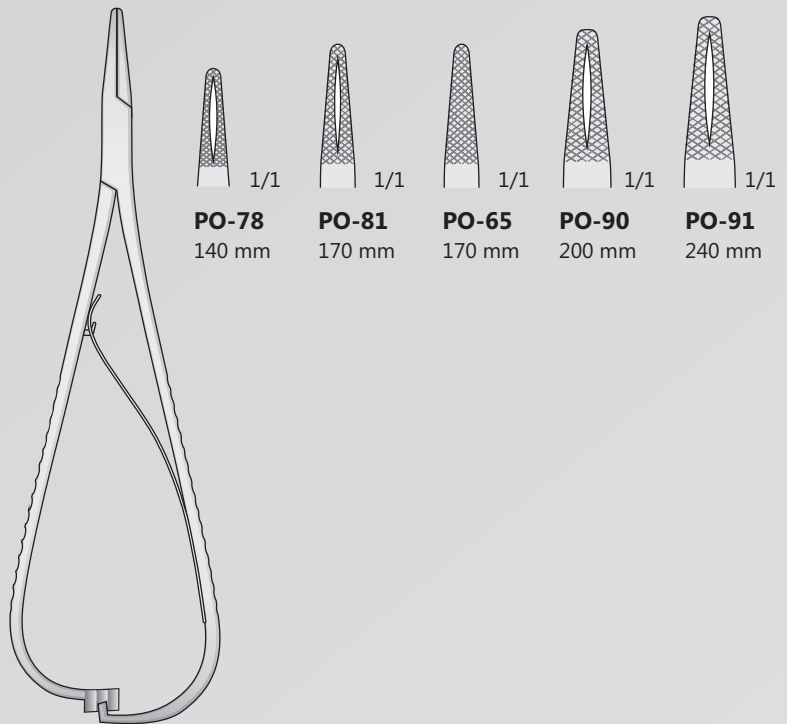

MATHIEU
PO-78/PO-91

PO-78 140 mm
PO-81 170 mm
PO-65 170 mm
PO-90 200 mm
PO-91 240 mm

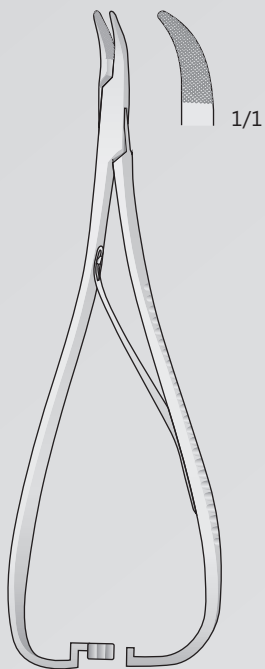

PO-40
140 mm

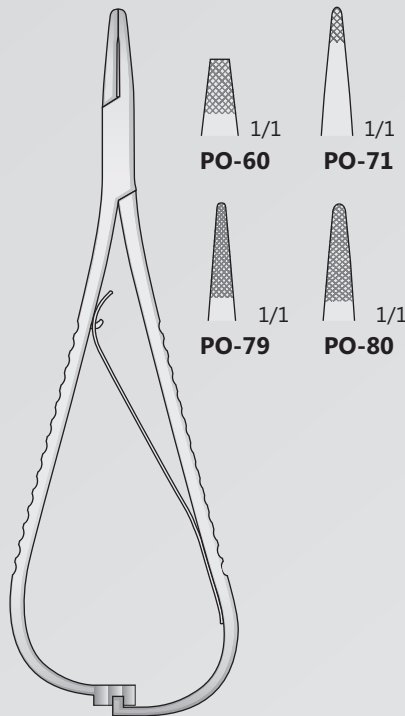

MATHIEU
PO-60/PO-80
140 mm

PO-60 1/1
PO-71 1/1
PO-79 1/1
PO-80 1/1

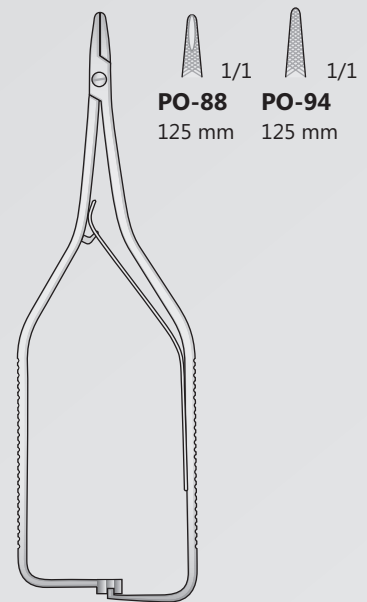

BOYNTON
PO-88/PO-94
125 mm

PO-88 125 mm
PO-94 125 mm

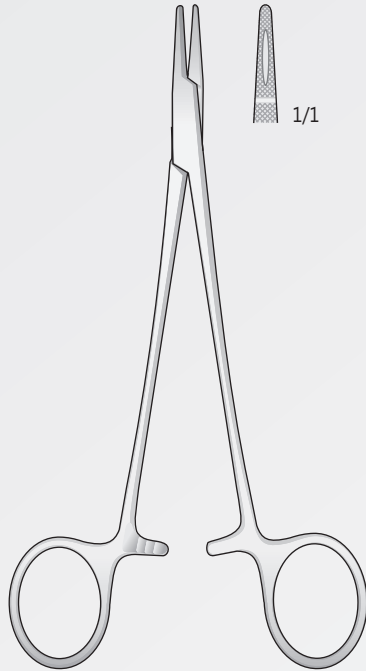

CRILE-WOOD
PH-61
150 mm

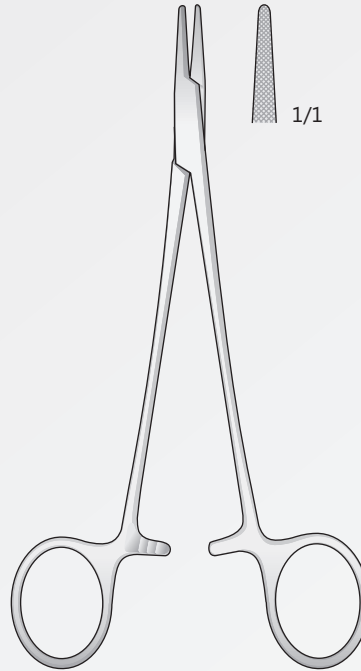

CRILE-MURRAY
PH-62
150 mm

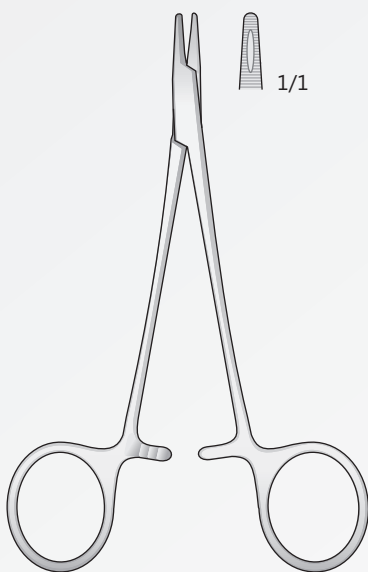

DERF
PH-39
125 mm

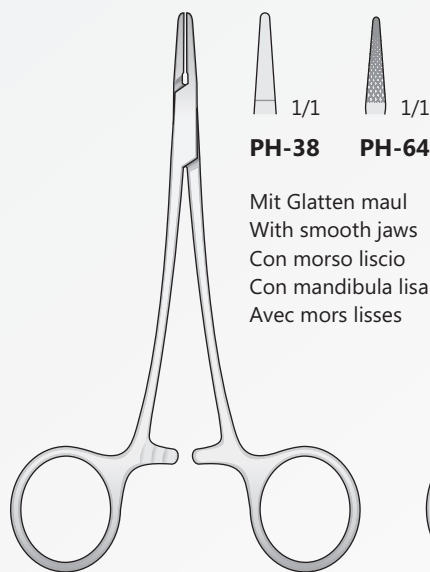

PH-38/PH-64
120 mm

Mit Glatten mau
With smooth jaws
Con morso liscio
Con mandibula lisa
Avec mors lisses

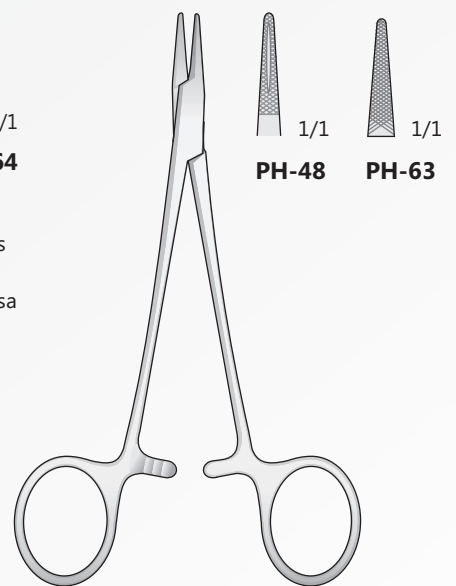

HALSEY
PH-48/PH-63
130 mm

Nadelhalter
Needle Holders
Port'aghi
Portaagujas
Porte aiguilles

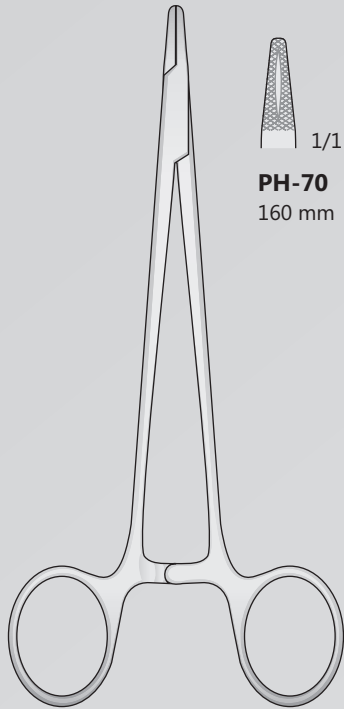

HEGAR
PH-70/PH-78

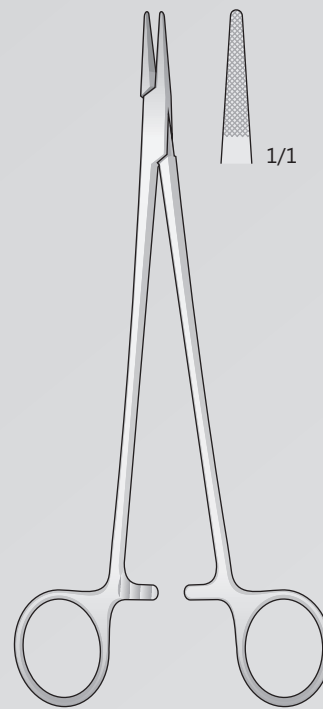
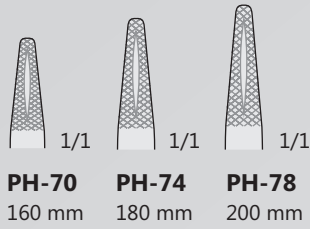

HEGAR-MAYO-SEELEY
PH-46
200 mm

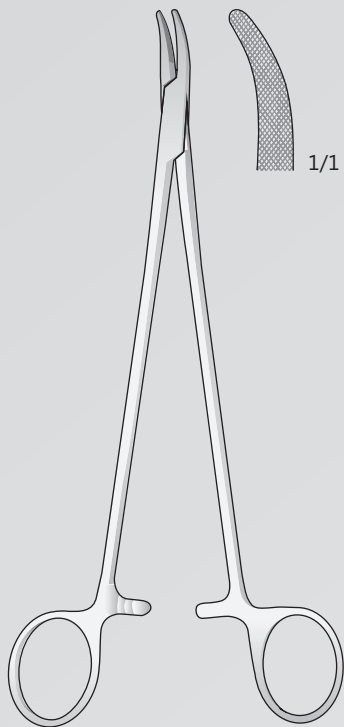
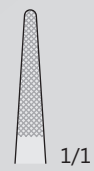

HEANEY (HEGAR)
PH-52
200 mm

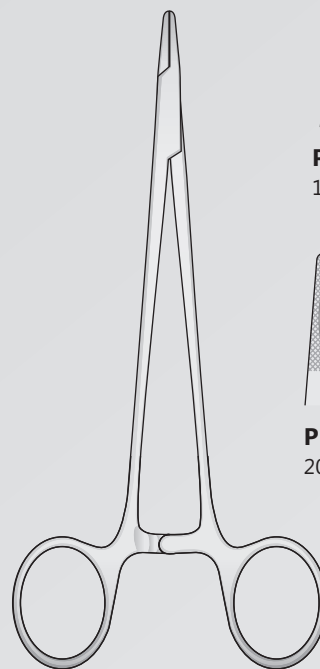
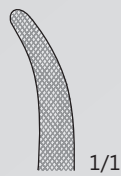

MAYO-HEGAR
PH-40/PH-45

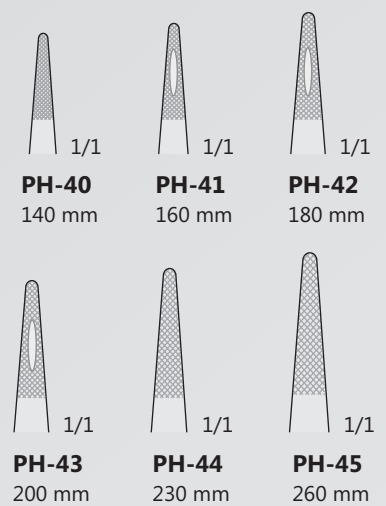

Schlankesmodell
Delicate pattern
Modello fine
Modelo delegado
Modèle fin

Nadelhalter mit Schere
Needle Holders with Scissors
Port'aghi con forbici
Portaagujas con tijeras
Porte aiguilles avec ciseaux

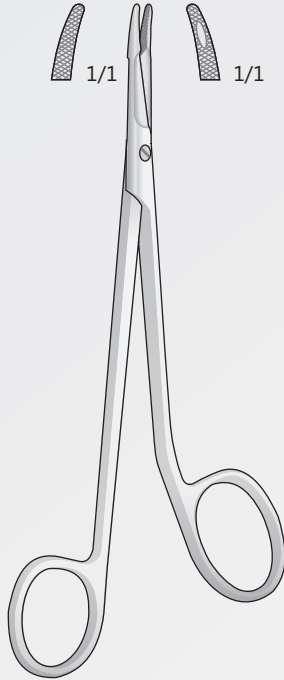

MINI-GILLIES
PO-59
145 mm

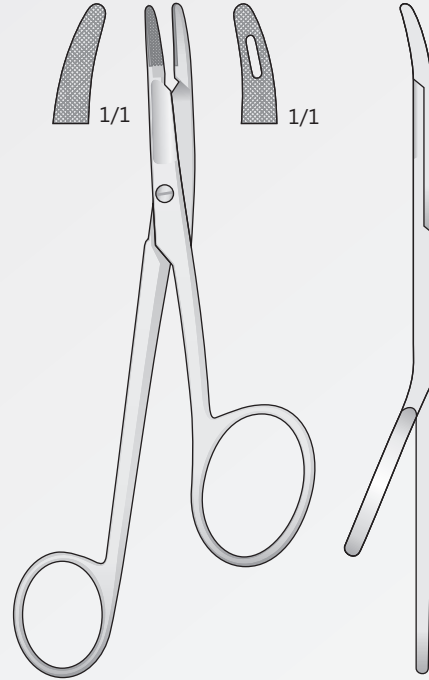

GILLIES
PO-89
160 mm



OLSEN-HEGAR
BM-61/BM-62

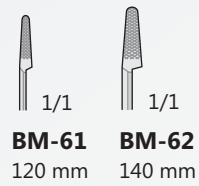

OLSEN-HEGAR
BM-63/BM-64

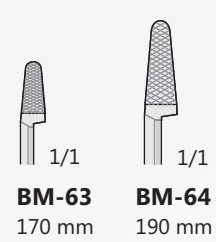



BONTEMPI
CHIRURGISCHE INSTRUMENTE

Wundhaken, Instrumente für Thorax
Retractors, Instruments for Thoracic
Divaricatori, Chirurgia Toracica
Separadores, Cirugia Toràcica
Ecarteurs, Chirurgie Thoracique

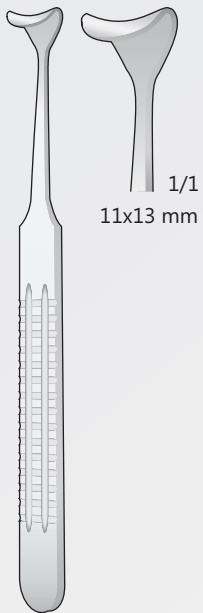

11x13 mm
1/1

DESMARRES
BT-28
160 mm

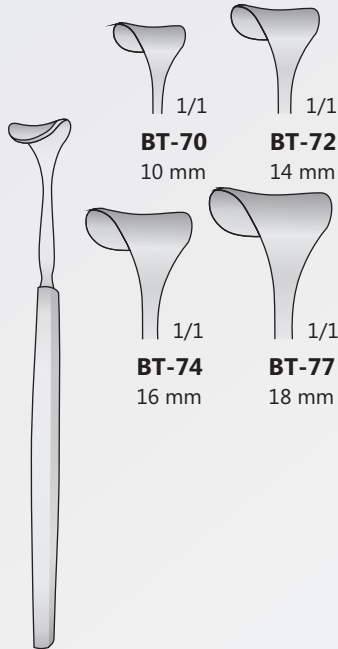

BT-70 10 mm 1/1
BT-72 14 mm 1/1
BT-74 16 mm 1/1
BT-77 18 mm 1/1

DESMARRES
BT-70/BT-77
140 mm

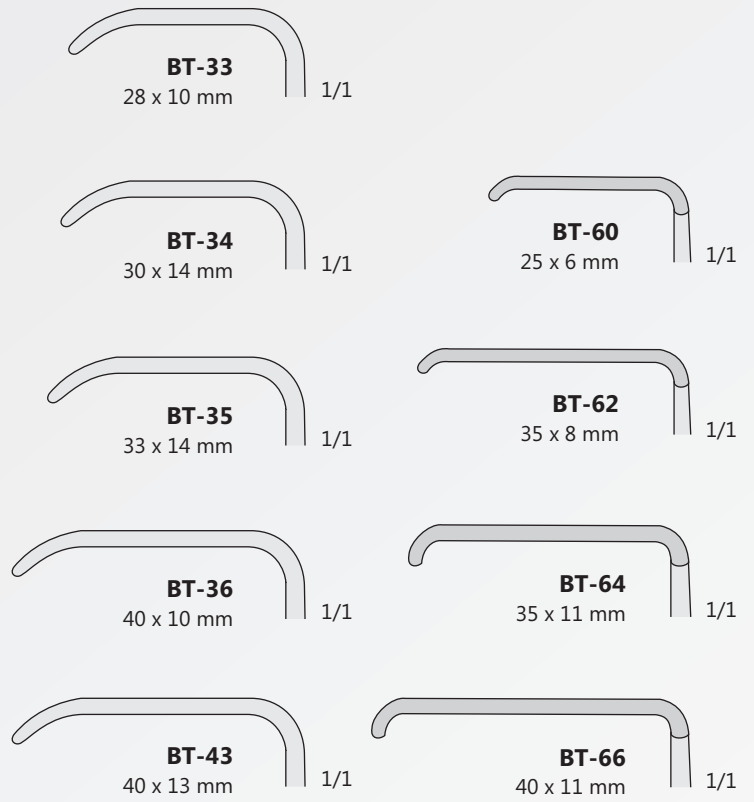

BT-33
28 x 10 mm 1/1

BT-34
30 x 14 mm 1/1

BT-35
33 x 14 mm 1/1

BT-36
40 x 10 mm 1/1

BT-43
40 x 13 mm 1/1

BT-60
25 x 6 mm 1/1

BT-62
35 x 8 mm 1/1

BT-64
35 x 11 mm 1/1

BT-66
40 x 11 mm 1/1

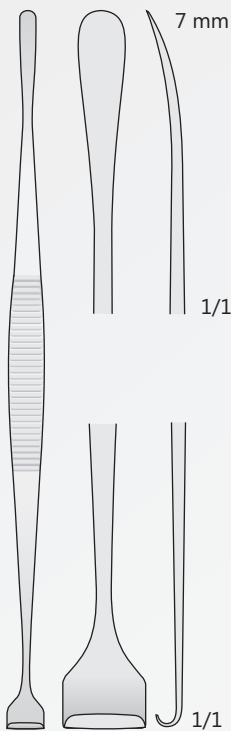

7 mm

1/1

1/1

HURD
BT-1
220 mm

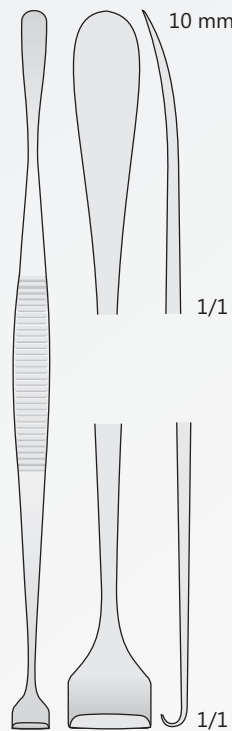

10 mm

1/1

1/1

HURD
BT-2
220 mm



LANGENBECK
BT-33/BT-43
210 mm

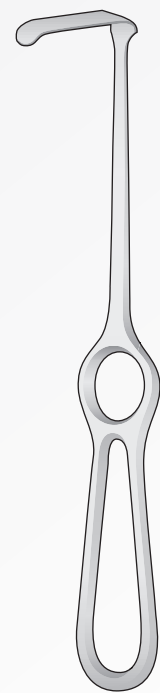

KOCHER-LANGENBECK
BT-60/BT-66
215 mm

Wundhaken
Retractors
Divaricatori
Separadores
Ecarteurs

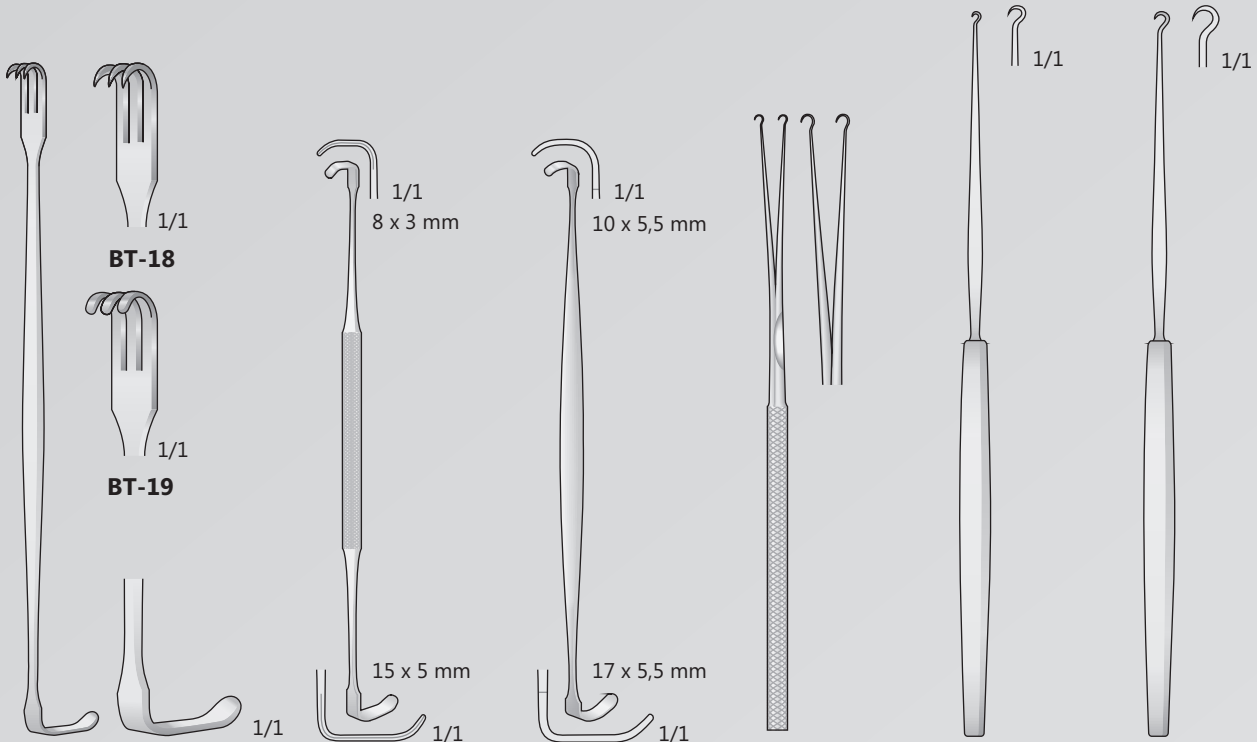

SENN-MILLER
BT-18/BT-19
160 mm

RAGNELL
BT-27
140 mm

RAGNELL-DAVIS
BT-26
140 mm

BARSKY
BT-370
150 mm

GILLIES
BT-15
180 mm

GILLIES
BT-16
180 mm

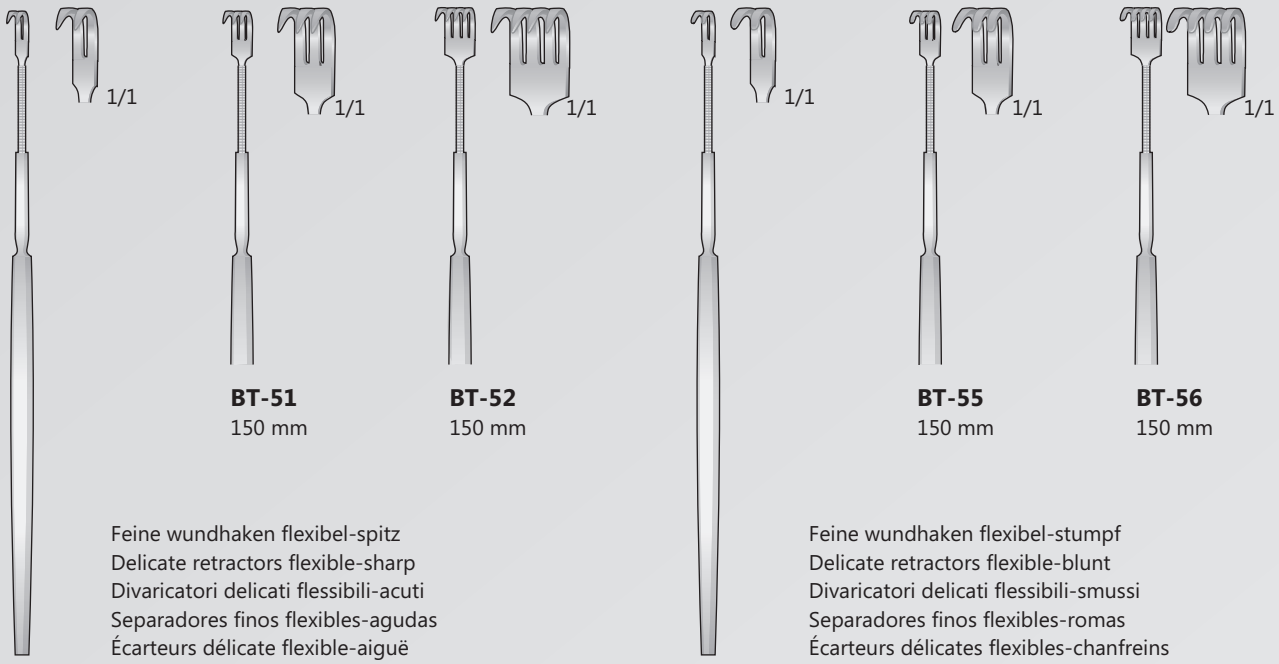

BT-50
150 mm

Feine wundhaken flexibel-spitz
Delicate retractors flexible-sharp
Divaricatori delicati flessibili-acuti
Separadores finos flexibles-agudas
Écarteurs délicates flexible-aiguë

BT-54
150 mm

Feine wundhaken flexibel-stumpf
Delicate retractors flexible-blunt
Divaricatori delicati flessibili-smussi
Separadores finos flexibles-romas
Écarteurs délicates flexibles-chanfreins

BT-283

Set completo
Set complete
Komplettset
Set complet
Set completo

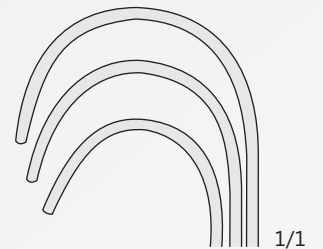

BT-284 - 20x22 mm
25x28 mm

BT-285 - 23x26 mm
29x38 mm

BT-286 - 29x29 mm
34x44 mm

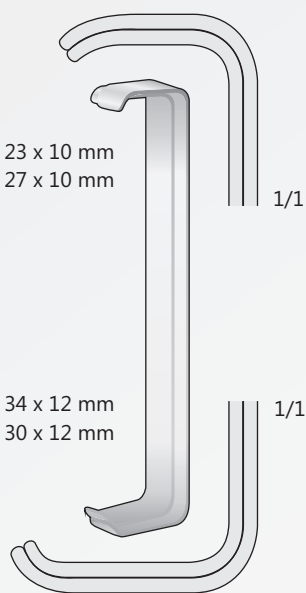

FARABEU
BT-20
120 mm

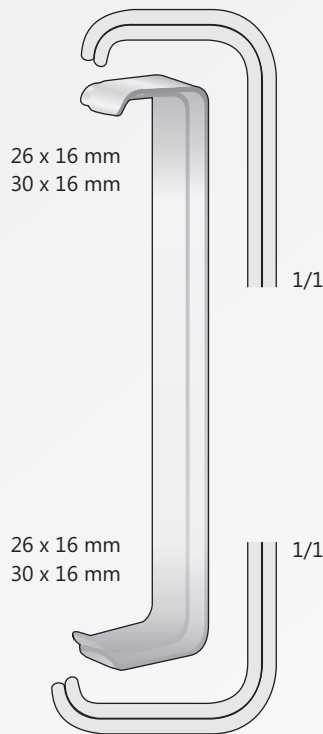

FARABEU
BT-25
150 mm

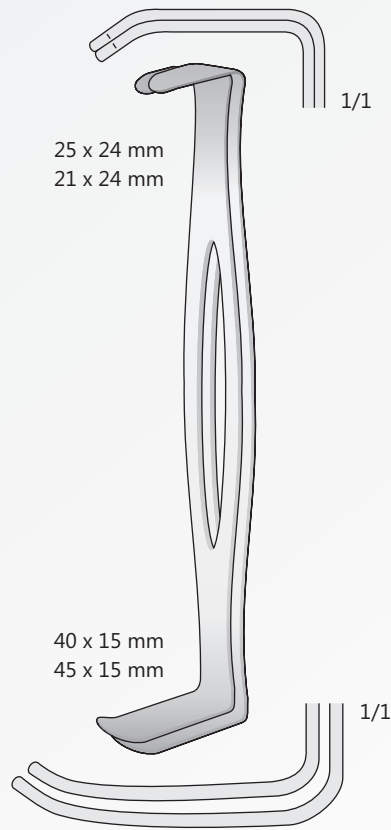

PARKER-LANGENBECK
BT-291
210 mm



ROUX
BT-284/BT-286
165 mm

Wundhaken
Retractors
Divaricatori
Separadores
Ecarteurs

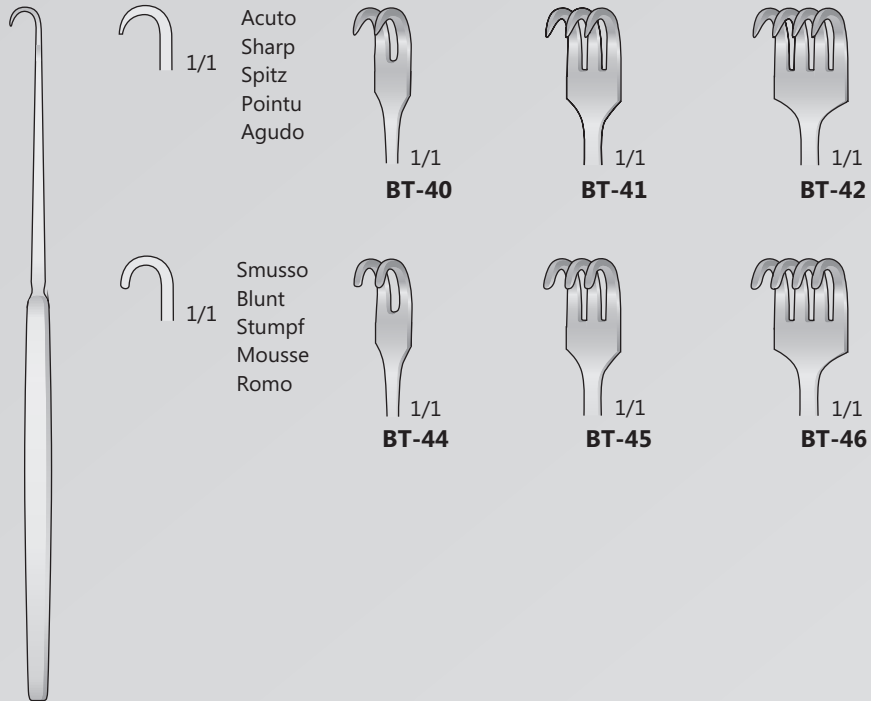

BT-40/BT-46
160 mm

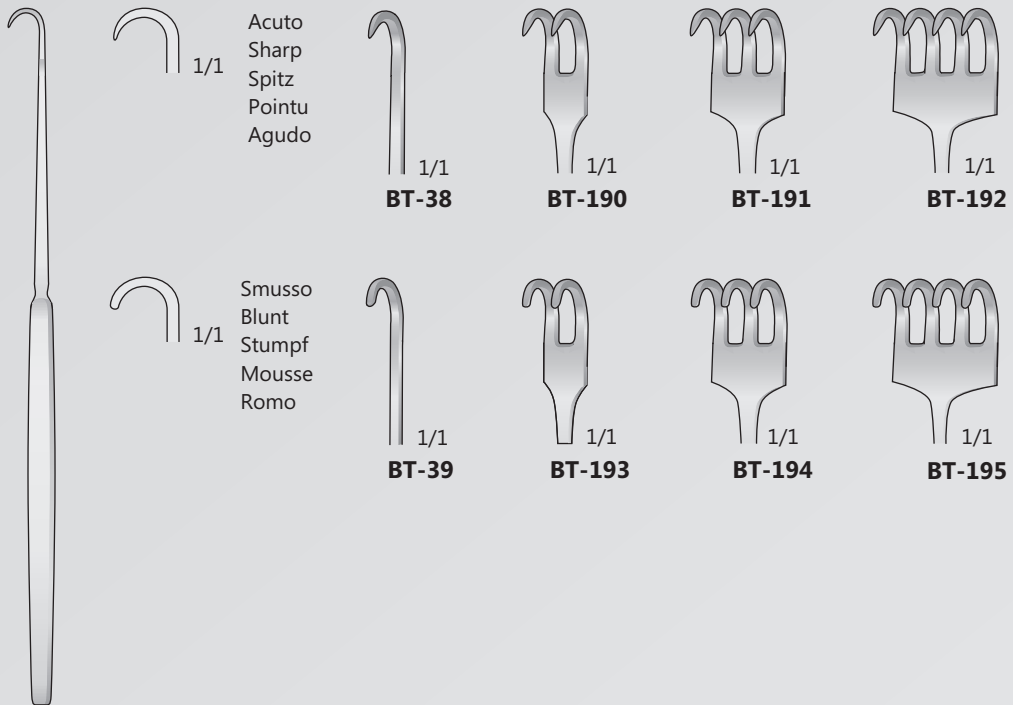

BT-38/BT-195
160 mm

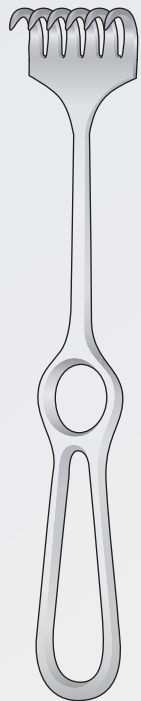

VOLKMANN
BT-101/BT-108
220 mm

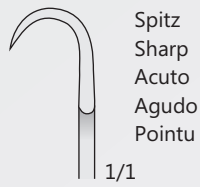

Spitz
Sharp
Acuto
Agudo
Pointu

1/1



BT-101
9 x 8 mm



BT-103
9 x 13 mm



BT-105
9 x 19 mm



BT-107
9 x 29 mm

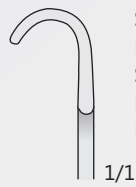

Stumpf
Blunt
Smusso
Romo
Mousse

1/1



BT-102
9 x 8 mm



BT-104
9 x 13 mm



BT-106
9 x 19 mm

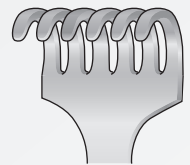

BT-108
9 x 29 mm



KOCHER
BT-141/BT-148
220 mm



Spitz
Sharp
Acuto
Agudo
Pointu

1/1



BT-141
16 x 9 mm



BT-143
16 x 14 mm



BT-145
16 x 20 mm



BT-147
16 x 30 mm



Stumpf
Blunt
Smusso
Romo
Mousse

1/1



BT-142
16 x 9 mm



BT-144
16 x 14 mm



BT-146
16 x 20 mm

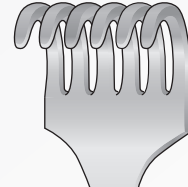

BT-148
16 x 30 mm

Wundspreizer
Retractors
Divaricatori
Separadores
Ecarteurs

GELPI Spreizer mit Schließung Zehen gekreuzt
Retractor GELPI with closure toes crossed
Retrattori GELPI con chiusura a punte incrociate
Retractor GELPI con dedos cruzados de cierre
Écarteur GELPI avec orteils de fermeture croisés

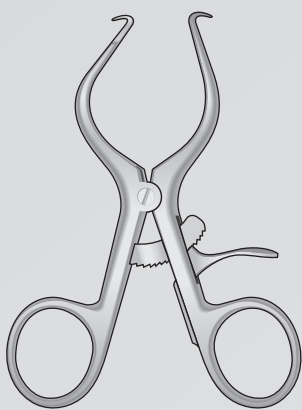
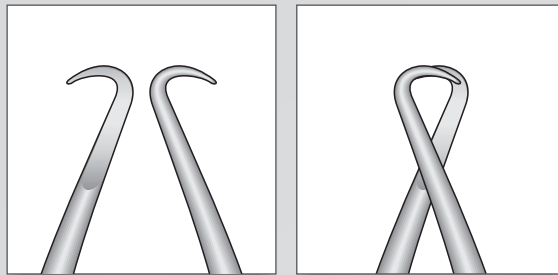

BV-914
90 mm

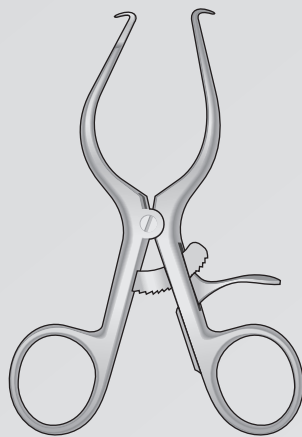

BV-915
110 mm

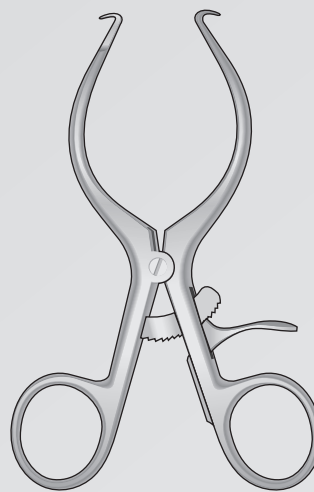

BV-916
140 mm

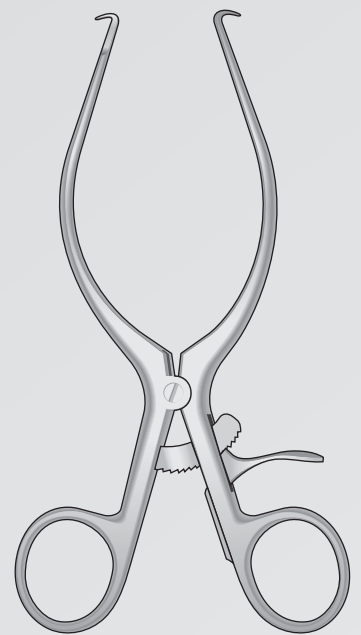

BV-917
180 mm

Wundspreizer
Retractors
Divaricatori
Separadores
Ecarteurs



1/1

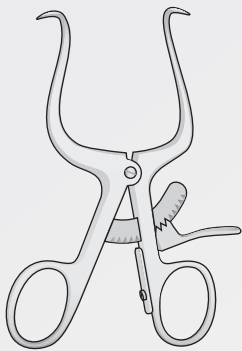

GELPI
BV-14
90 mm

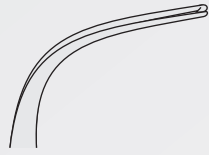

1/1

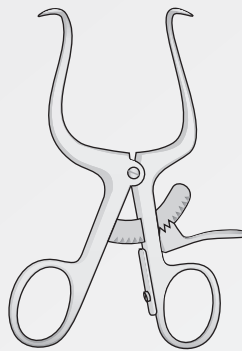

GELPI
BV-14M
90 mm

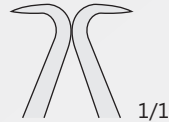

1/1

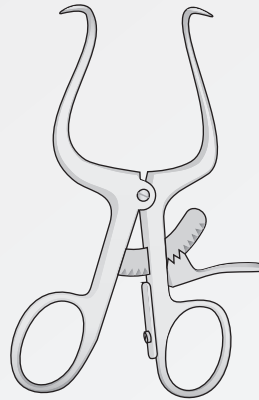

GELPI
BV-15
110 mm

Femur-Wundspreizer
Femur Retractor
Divaricatore femorale
Retractor femoral
Ecarteur fémoral

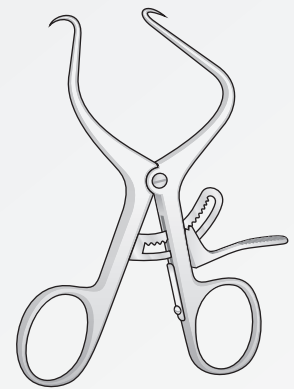
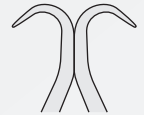

DE BAKEY
BV-315
100 mm

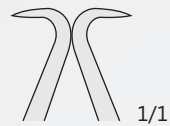

1/1

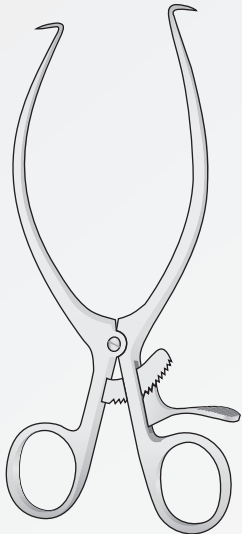

GELPI
BV-16
140 mm

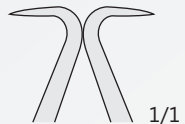

1/1

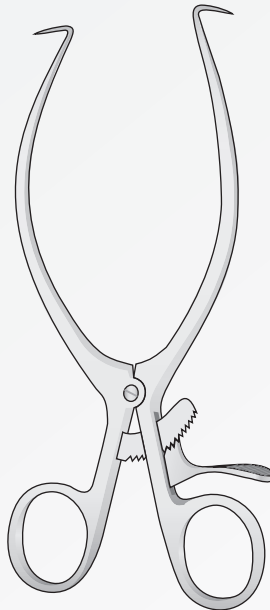

GELPI
BV-17
180 mm

Femur-Wundspreizer
Femur Retractor
Divaricatore femorale
Retractor femoral
Ecarteur fémoral

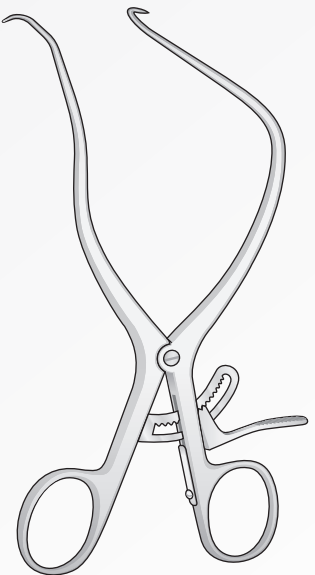
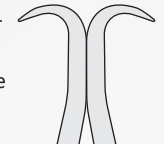

DE BAKEY
BV-316
170 mm

Wundspreizer
Retractors
Divaricatori
Separadores
Ecarteurs

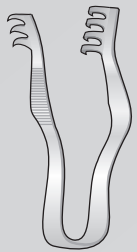

FINSEN
BV-36/BV-39
50 mm



1/1

BV-36

Acuto
Sharp
Spitz
Pointù
Agudas



1/1

BV-37

Smusso
Blunt
Stumpf
Mousse
Romas



1/1

BV-38

Acuto
Sharp
Spitz
Pointù
Agudas



1/1

BV-39

Smusso
Blunt
Stumpf
Mousse
Romas

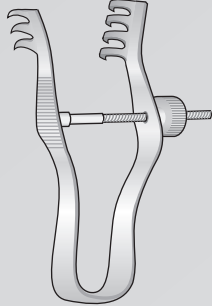

FINSEN
BV-47/BV-48
70 mm



1/1

BV-47

Acuto
Sharp
Spitz
Pointù
Agudas



1/1

BV-48

Smusso
Blunt
Stumpf
Mousse
Romas

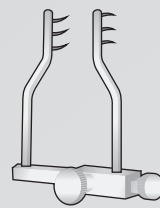

LOGAN
BV-45
40 mm



1/1



BV-08
100 mm

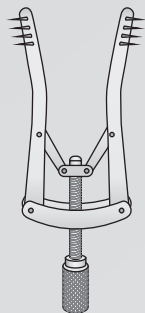

ALM
BV-12/BV-49
70 mm



1/1

BV-12

Acuto
Sharp
Spitz
Pointù
Agudas



1/1

BV-49

Smusso
Blunt
Stumpf
Mousse
Romas

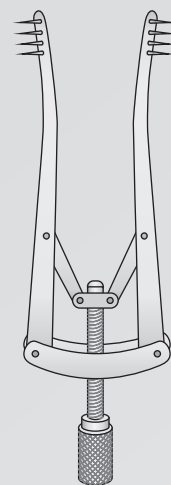

ALM
BV-10/BV-51
100 mm



1/1

BV-10

Acuto
Sharp
Spitz
Pointù
Agudas



1/1

BV-51

Smusso
Blunt
Stumpf
Mousse
Romas

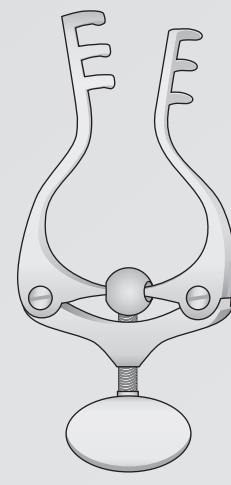

JANSEN
BV-52
100 mm

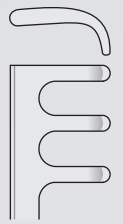

Smusso
Blunt
Stumpf
Mousse
Romas

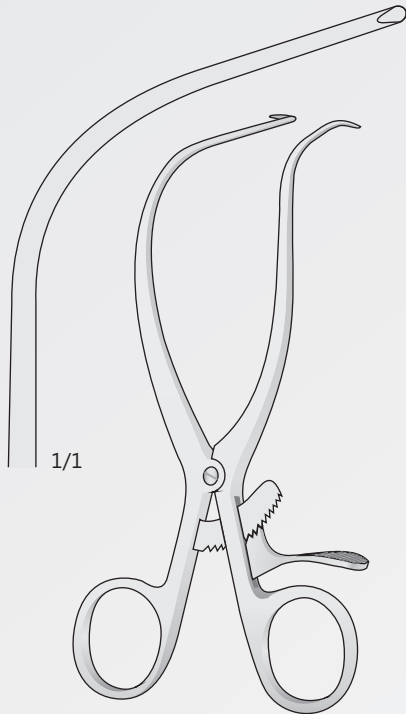

GELPI-SELETZ
BV-11
165 mm

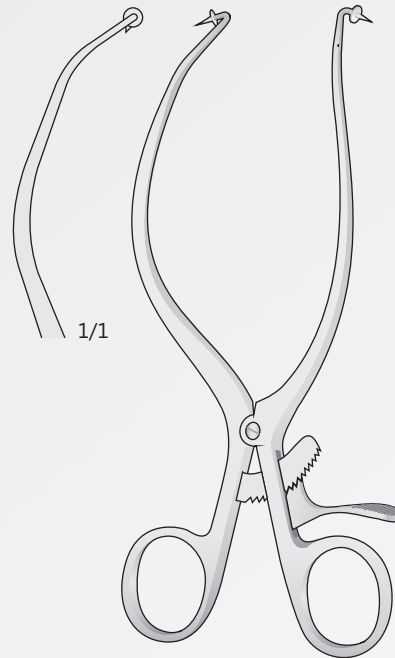

GELPI-LOKTITE
BV-13
190 mm

Mit Kugel
With stop
Con stop
Con alto
Avec stop

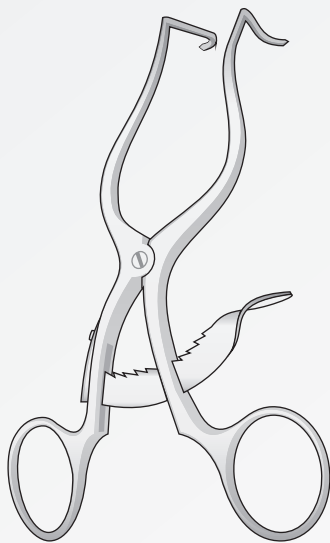

CLOWARD-CONTOUR
BV-108
140 mm

Spitz
Scharp
Acuto
Agudo
Pointu

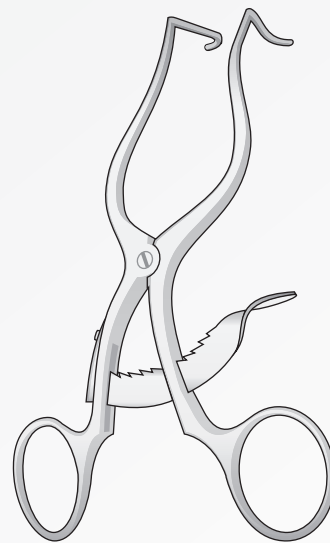

CLOWARD-CONTOUR
BV-109
140 mm

Stumpf
Blunt
Smusso
Romas
Mousse

Wundspreizer
Retractors
Divaricatori
Separadores
Ecarteurs

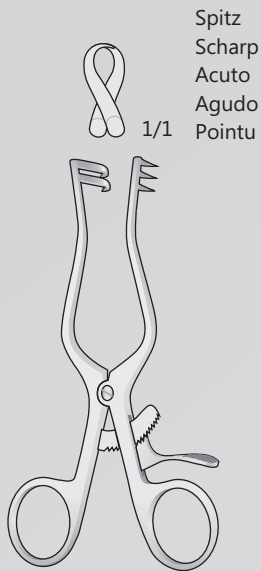

WEITLANER
BV-07
110 mm

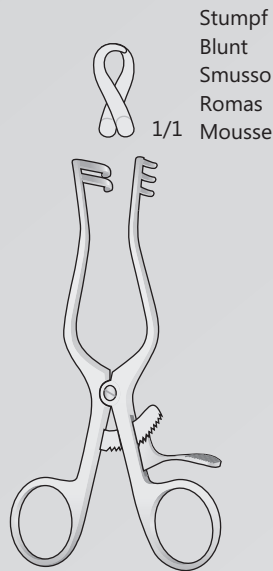

WEITLANER
BV-09
110 mm

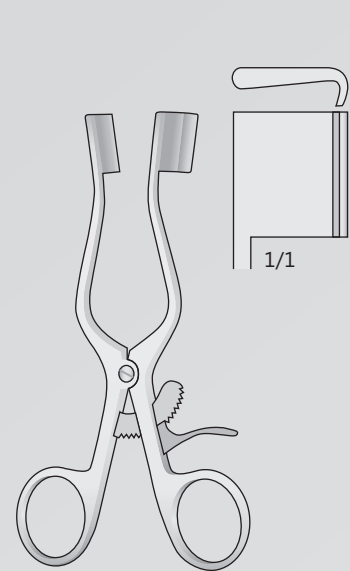

BABY-WEITLANER
BV-26
140 mm

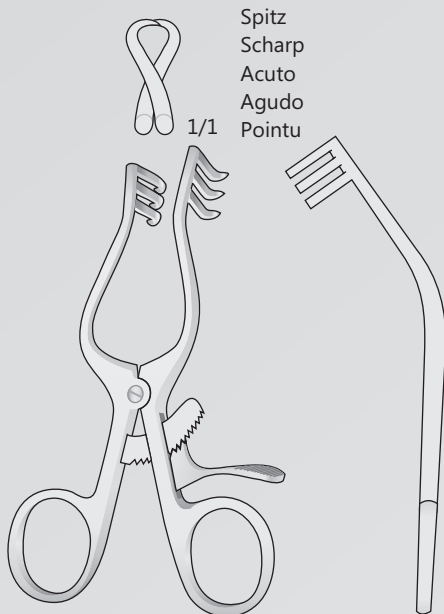

WULLSTEIN
BV-111
105 mm

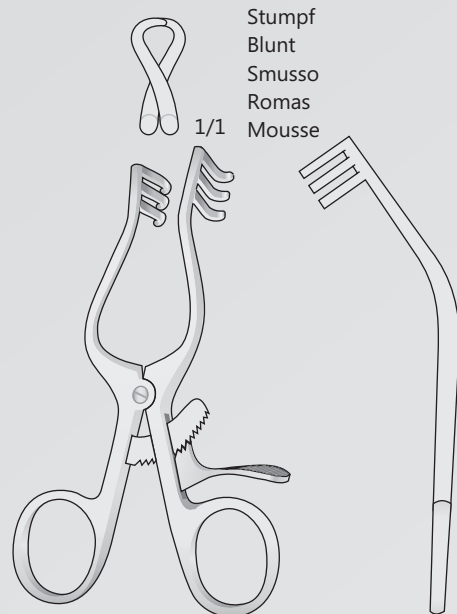

WULLSTEIN
BV-112
105 mm

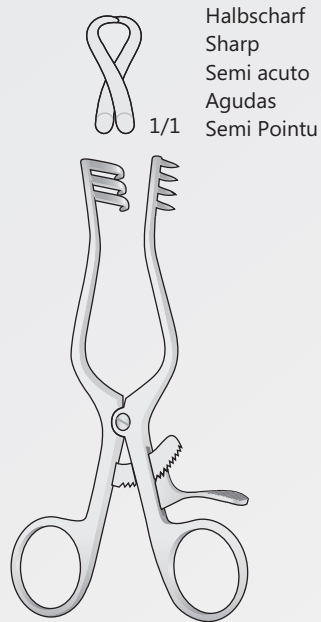

WEITLANER
BV-18
135 mm

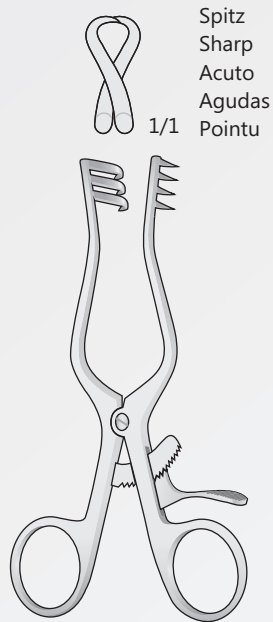

WEITLANER
BV-20
135 mm

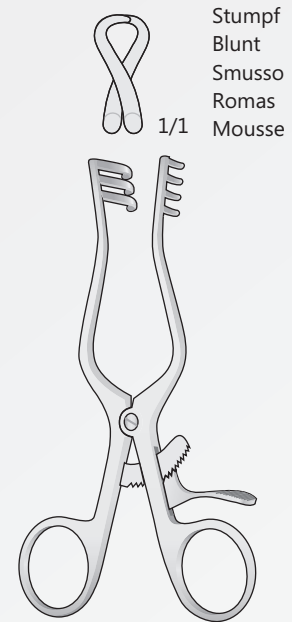

WEITLANER
BV-22
135 mm

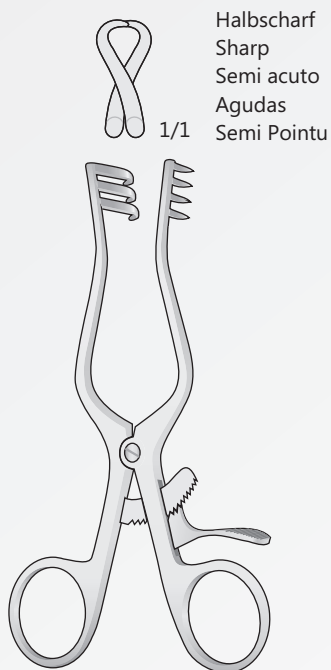

WEITLANER
BV-19
165 mm

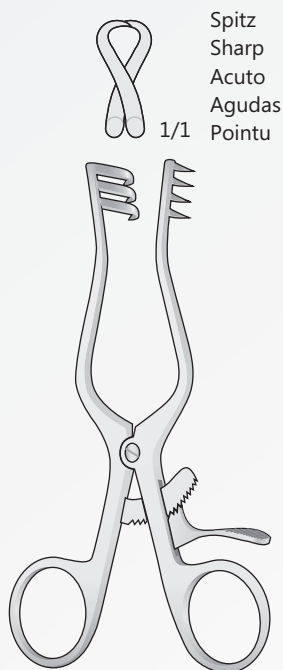

WEITLANER
BV-21
165 mm

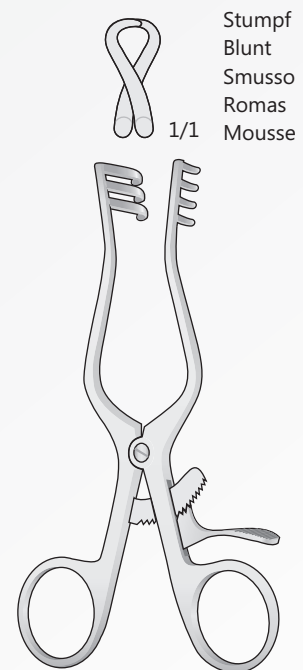

WEITLANER
BV-23
165 mm

Wundspreizer
Retractors
Divaricatori
Separadores
Ecarteurs

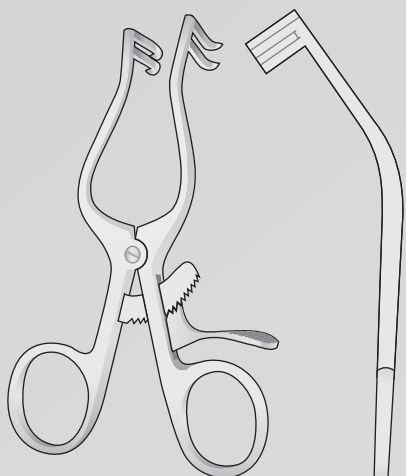
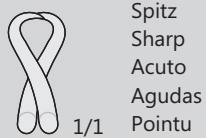

PLESTER
BV-90
110 mm

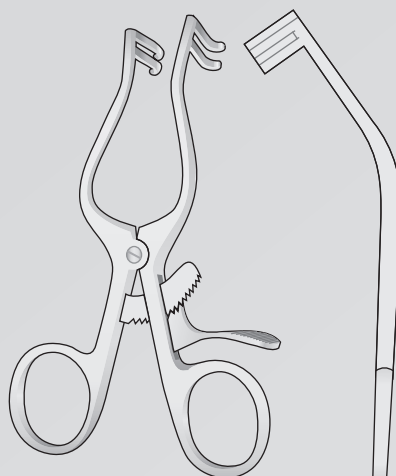
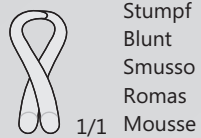

PLESTER
BV-91
110 mm

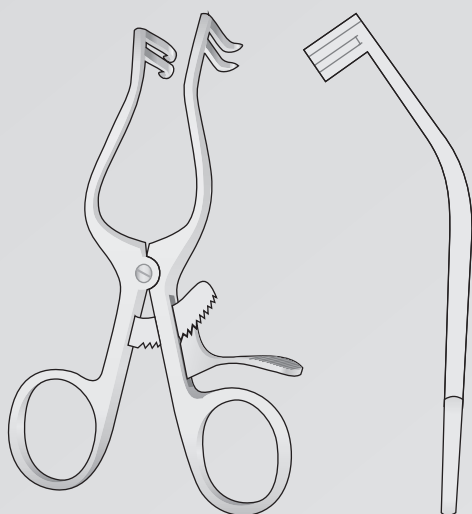
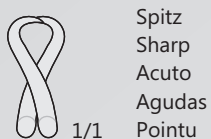

PLESTER
BV-92
135 mm

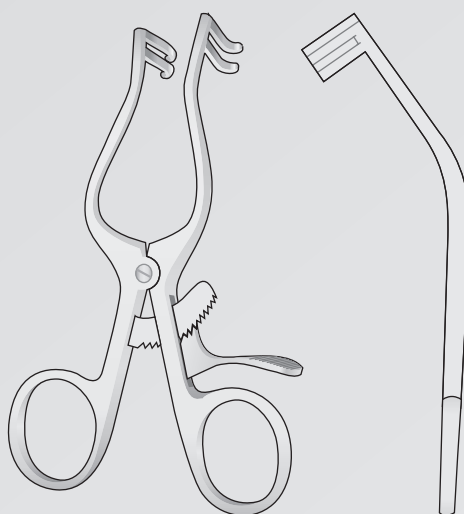
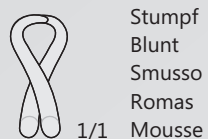

PLESTER
BV-93
135 mm

- BV-76** - 32 x 25 mm
- BV-77** - 60 x 25 mm
- BV-78** - 54 x 25 mm
- BV-79** - 60 x 20 mm

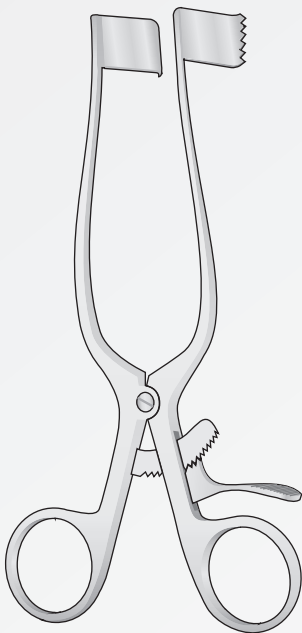

MEYERDING
BV-76/BV-79
180 mm

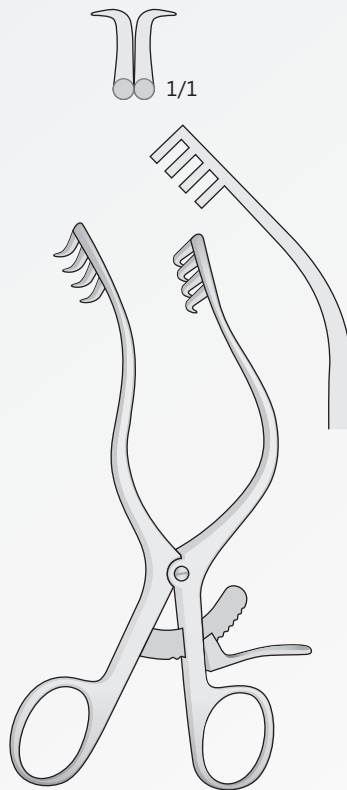

MOLLISON
BV-110
160 mm

Spitz
Sharp
Acuto
Agudas
Pointu

Stumpf
Blunt
Smusso
Romas
Mousse

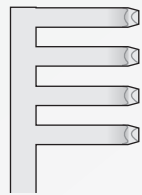
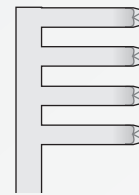
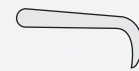

BV-117

BV-118



ANDERSON-ADSON
BV-117/BV-118
200 mm

Wundspreizer
Retractors
Divaricatori
Separadores
Ecarteurs

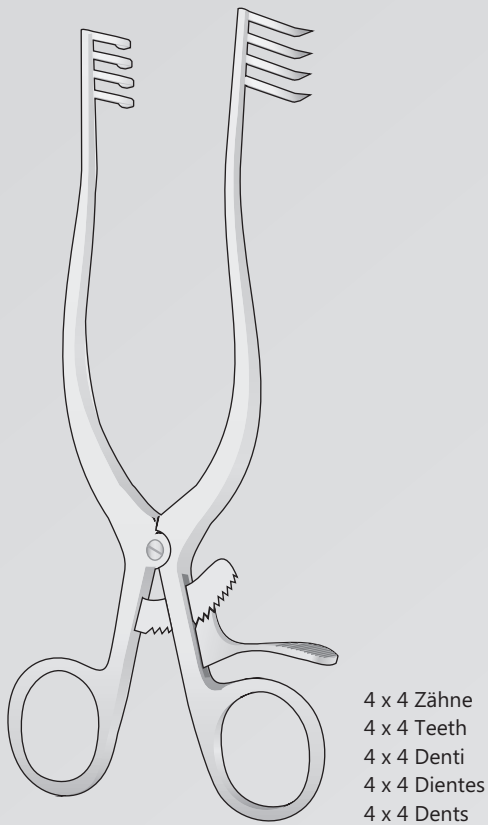
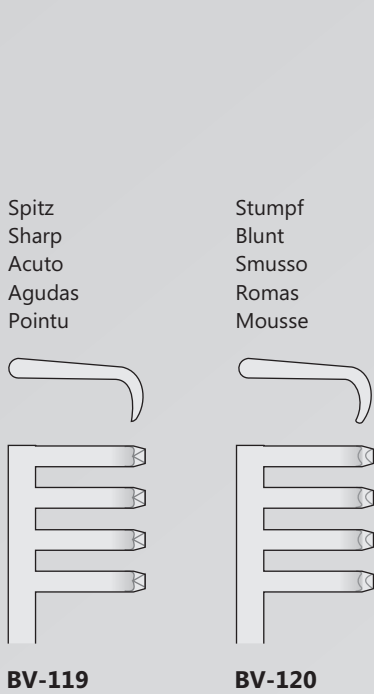

ADSON
BV-119/BV-120
200 mm

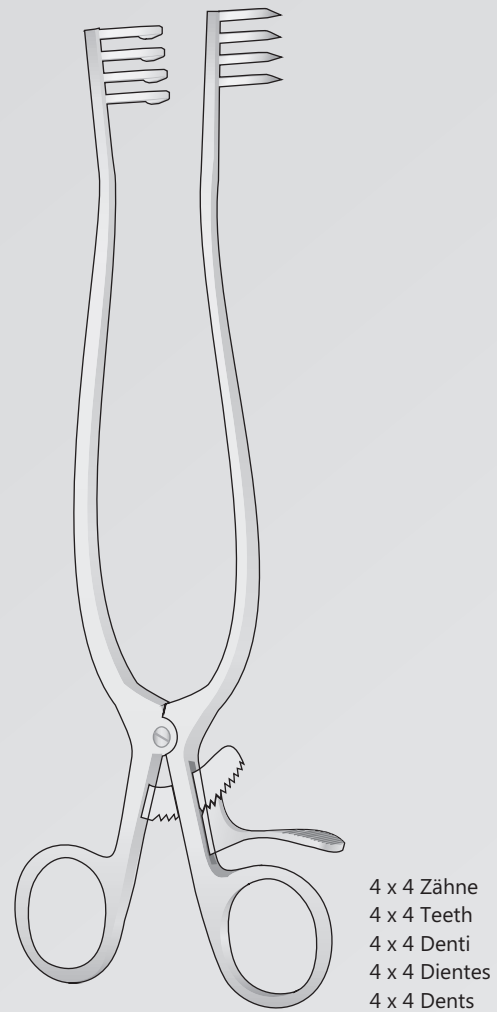
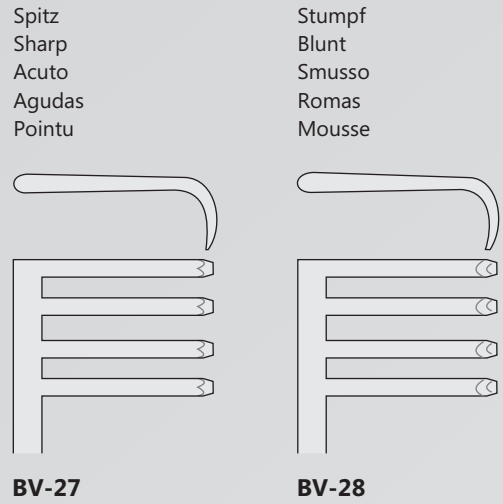

WEITLANER
BV-27/BV-28
250 mm

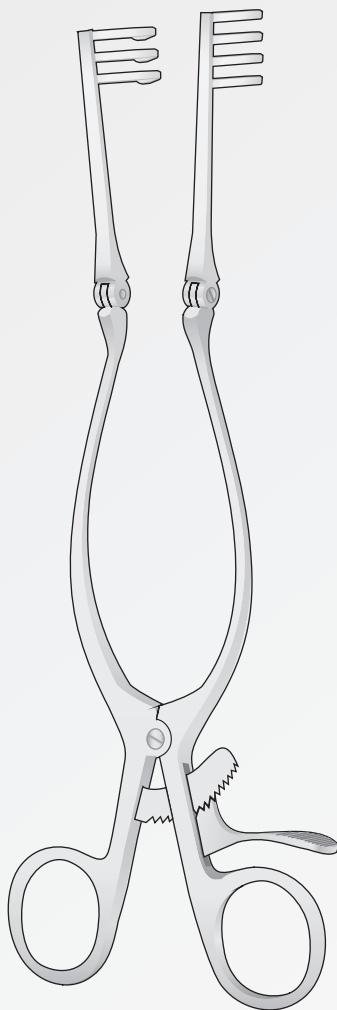

ADSON
BV-68/BV-75

3 x 4 Zähne
3 x 4 Teeth
3 x 4 Denti
3 x 4 Dientes
3 x 4 Dents

Spitz
Scharp
Acuto
Agudo
Pointu

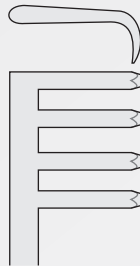

BV-68
140 mm

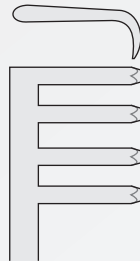

BV-69
165 mm

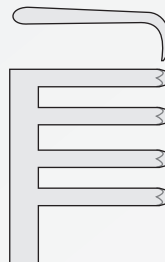

BV-72
200 mm

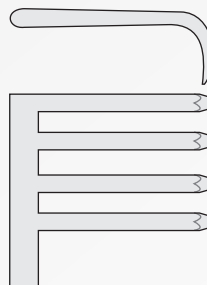

BV-74
250 mm

Stumpf
Blunt
Smusso
Romas
Mousse



BV-70
140 mm

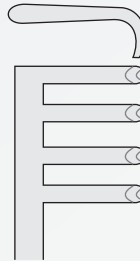

BV-71
165 mm

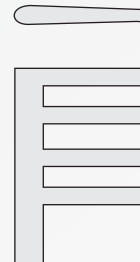

BV-73
200 mm

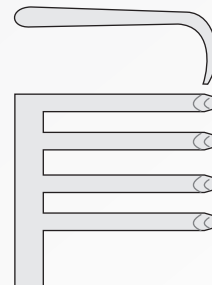

BV-75
250 mm

Wundspreizer
Retractors
Divaricatori
Separadores
Ecarteurs

Spreizer allein
Retractor without blades
Solo divaricatore senza valva
Separador sin valvas
Ecarteur sans valves

| | |
|--------|--------|
| Spitz | Stumpf |
| Scharp | Blunt |
| Acuto | Smusso |
| Agudo | Romas |
| Pointu | Mousse |

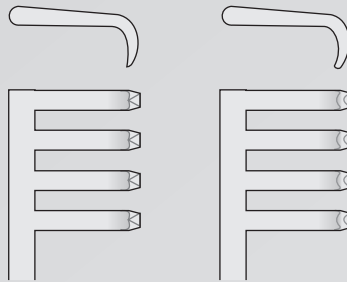

BV-135

BV-136

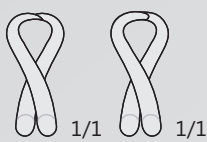
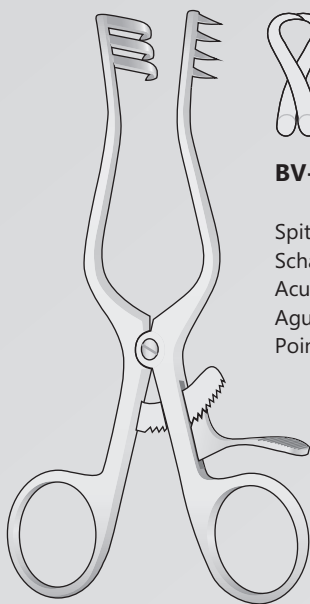

BV-24

BV-25

| | |
|--------|--------|
| Spitz | Stumpf |
| Scharp | Blunt |
| Acuto | Smusso |
| Agudo | Romas |
| Pointu | Mousse |

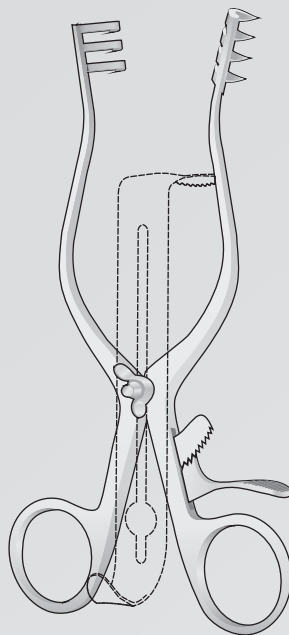

HENLEY
BV-135/BV-136
165 mm

3 x 4 Zähne
3 x 4 Teeth
3 x 4 Denti
3 x 4 Dientes
3 x 4 Dents

Mittelblatt
Center blades
Valve centrali
Valvas centrales
Valves centrale

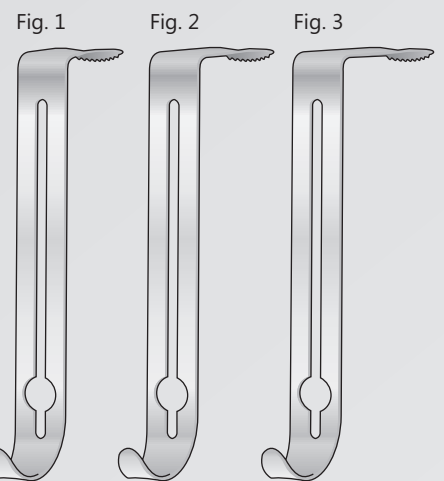

BV-137
16x19 mm

BV-138
16x25 mm

BV-139
16x32 mm

CLOWARD Modif.

BV-319

Sperrer, allein
Retractor, only
Divaricatore, solo
Separador, suelto
Ecarteur, seul

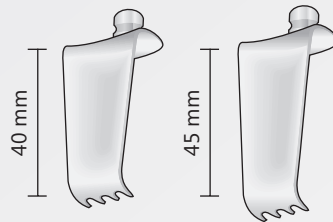

16 mm

BV-321

16 mm

BV-322

CLOWARD Modif.

BV-317

Sperrer, allein
Retractor, only
Divaricatore, solo
Separador, suelto
Ecarteur, seul

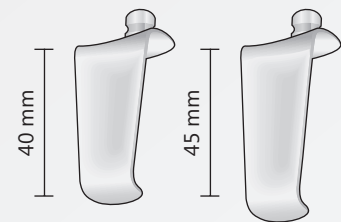

16 mm

BV-326

16 mm

BV-327

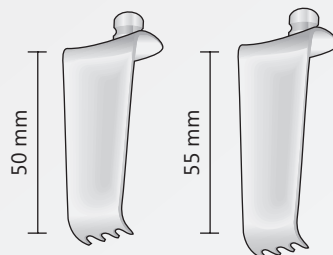

16 mm

BV-323

16 mm

BV-324

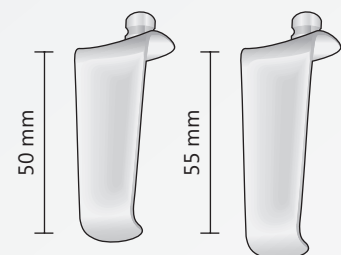

16 mm

BV-328

16 mm

BV-329

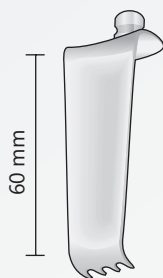

16 mm

BV-325

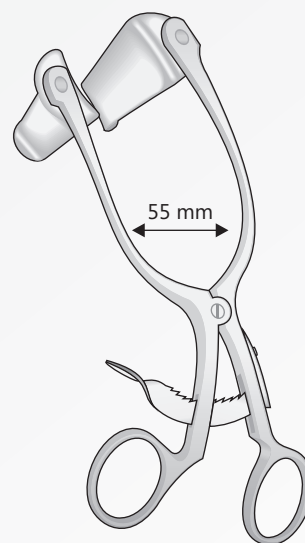

60 mm

16 mm

BV-330

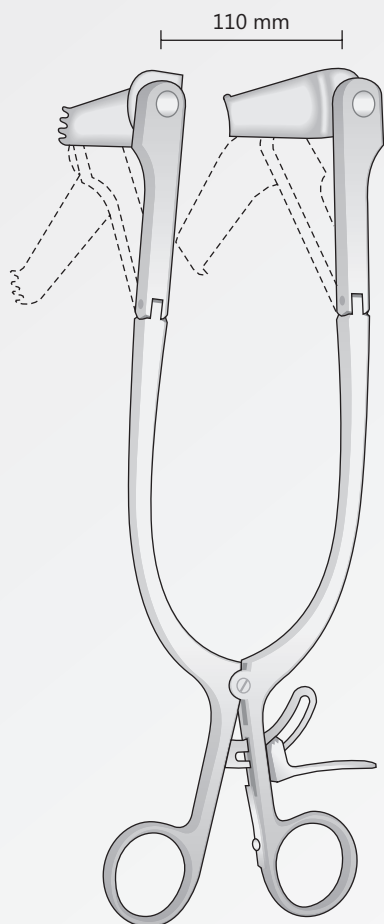

CLOWARD modif.

BV-320

250 mm

Komplett mit 5 Valven
Complete with 5 blades
Completo di 5 valve
Completo con 5 valvas
Complet avec 5 valves

CLOWARD

BV-318

160 mm

Komplett mit 5 Valven
Complete with 5 blades
Completo di 5 valve
Completo con 5 valvas
Complet avec 5 valves

Rippensperrer
Rib Spreaders
Divaricatori costali
Separadores costales
Ecarteurs costaux

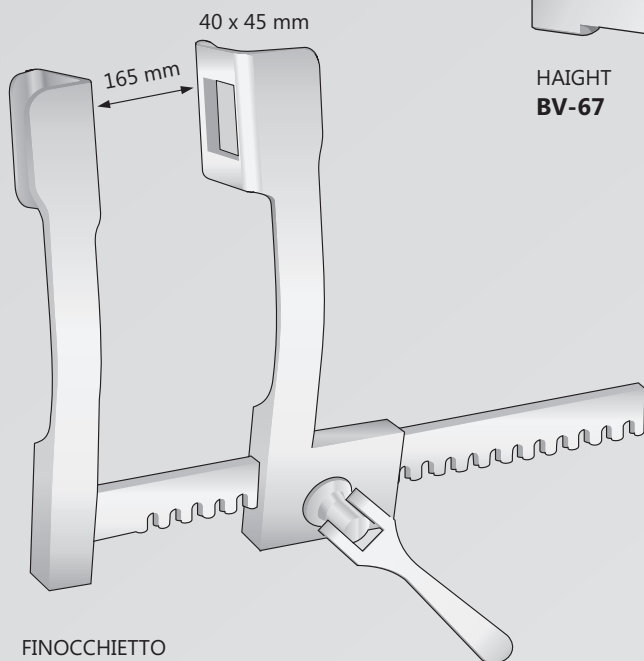
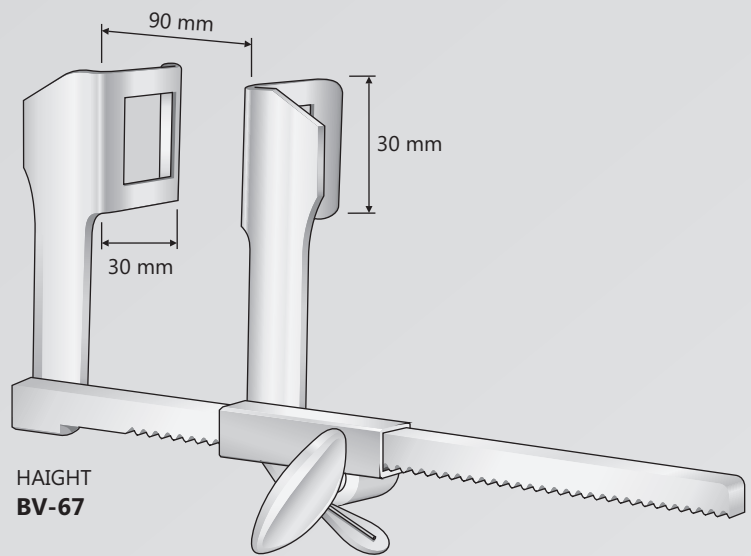
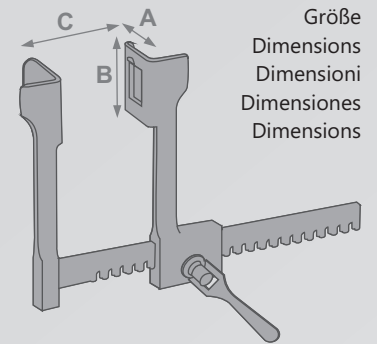
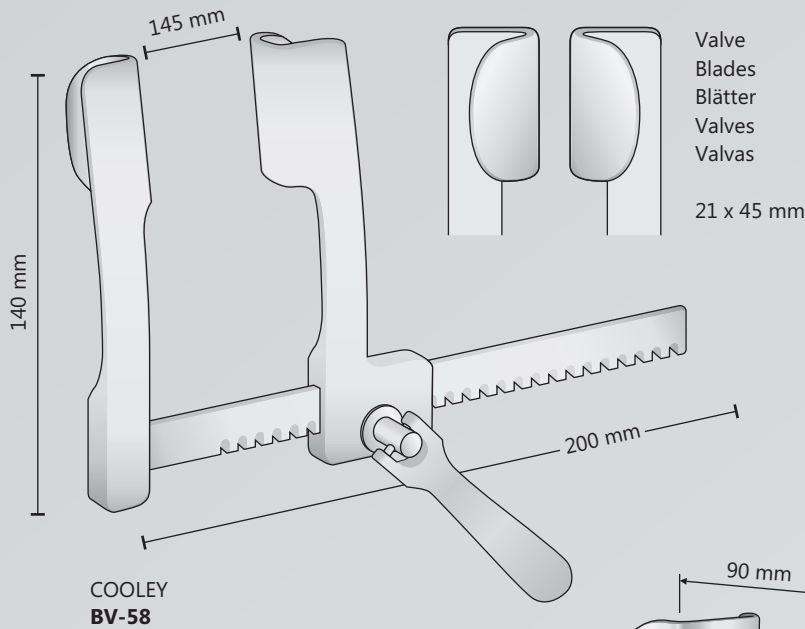

A: 40 mm B: 45 mm C: 165 mm

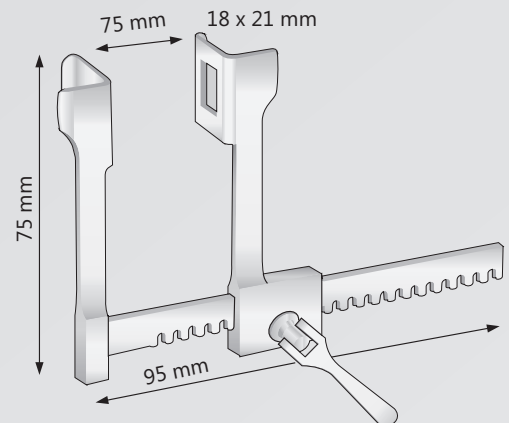

A: 18 mm B: 21 mm C: 75 mm

Wirbelkörperspreizer
Lamina-spreaders
Divaricatori vertebrali
Separadores vertebrales
Ecarteurs vertébrale

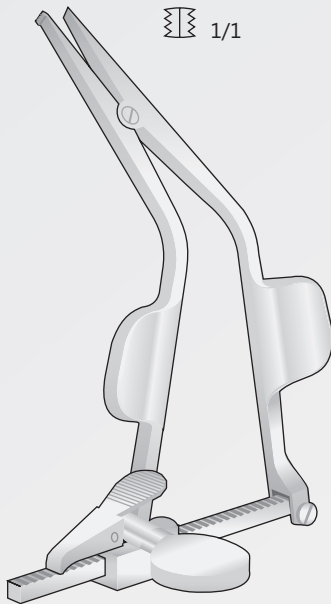

CLOWARD
BV-86
150 mm

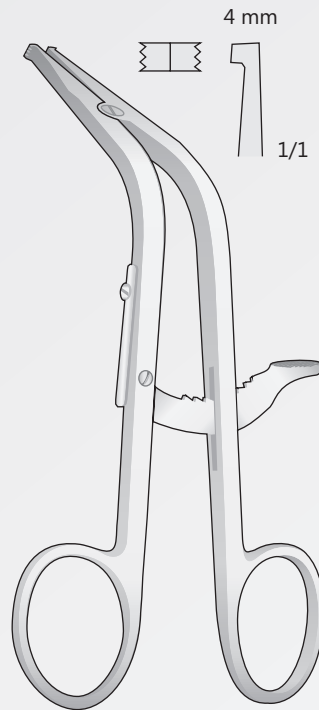

CLOWARD
BV-84
160 mm

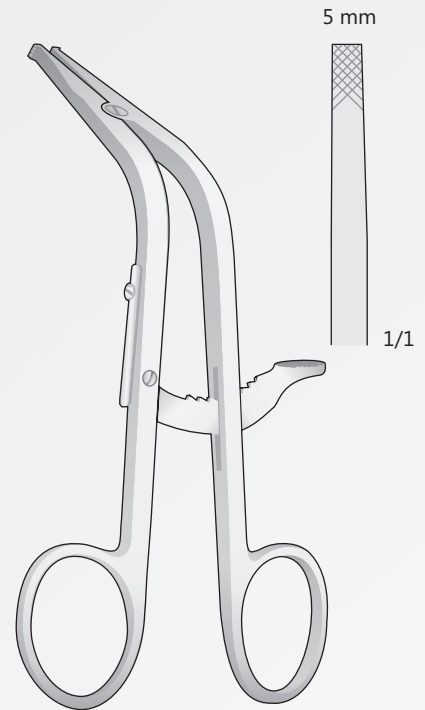

CLOWARD
BV-85
160 mm

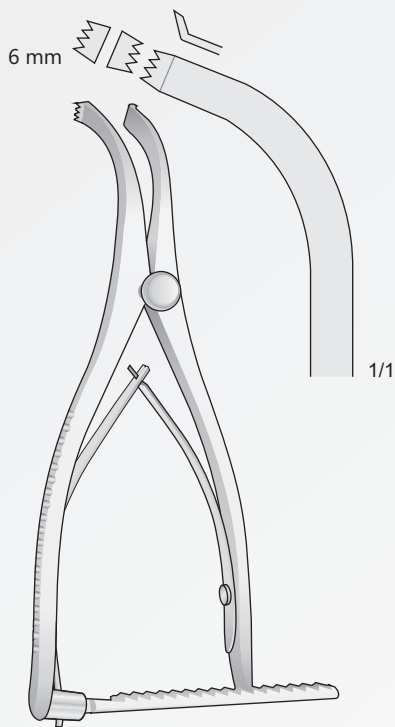

INGE
BV-80
160 mm

Rippenkontraktor
Rib Contractor
Approssimatore costale
Aproximador para costillas
Rapprocheur de côtes

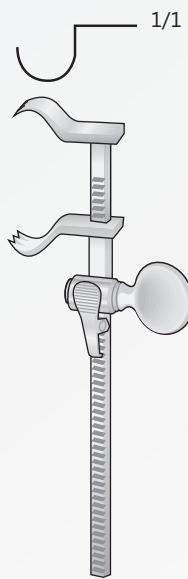

BAILEY-BABY
FB-296
160 mm

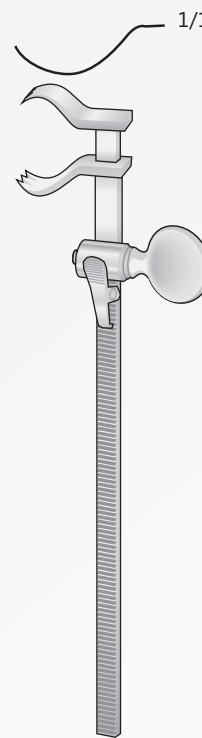

BAILEY
FB-297
200 mm

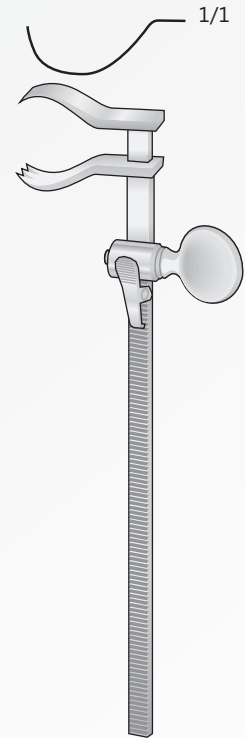

BAILEY
FB-298
200 mm

Bauchdeckenhalter
Abdominal retractors
Divaricatori addominali
Separadores abdominales
Ecarteurs Abdominaux

BV-141

Komplett mit 1 Paar Valven
Complete with 1 pairs of blades
Completo con un paio di valve
Completo con 1 pares de valvas
Complete avec 1 paires de valves

BV-146

Komplett mit 2 paar valven
Complete with 2 pairs of blades
Completo con due paia di valve
Completo con 2 pares de valvas
Complete avec 2 paires de valves

BV-142 20x44 mm

BV-143 30x44 mm

Seitl. Blätter - paar
Lateral blades - pairs
Valve laterali - paia
Valvas laterales - pares
Valves latérales - paires

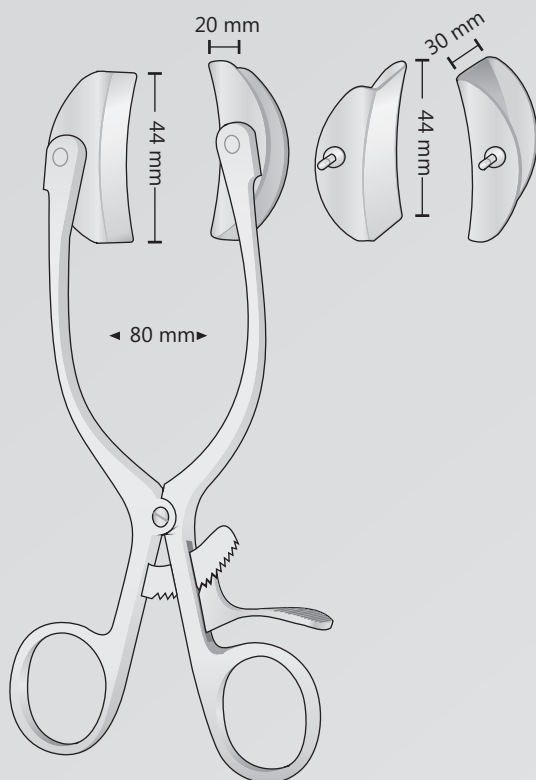

BABY-COLLIN

BV-141

180 mm

BV-145

Komplett mit 1 Paar Valven
Complete with 1 pairs of blades
Completo con un paio di valve
Completo con 1 pares de valvas
Complete avec 1 paires de valves

BV-372

32x62 mm

Seitl.blätter - paar
Lateral blades - pairs
Valve laterali - paia
Valvas laterales - pares
Valves latérales - paires

BV-148

Sperrer allein
Retractor only
Divaricatore solo
Separador suelto
Ecarteur seul

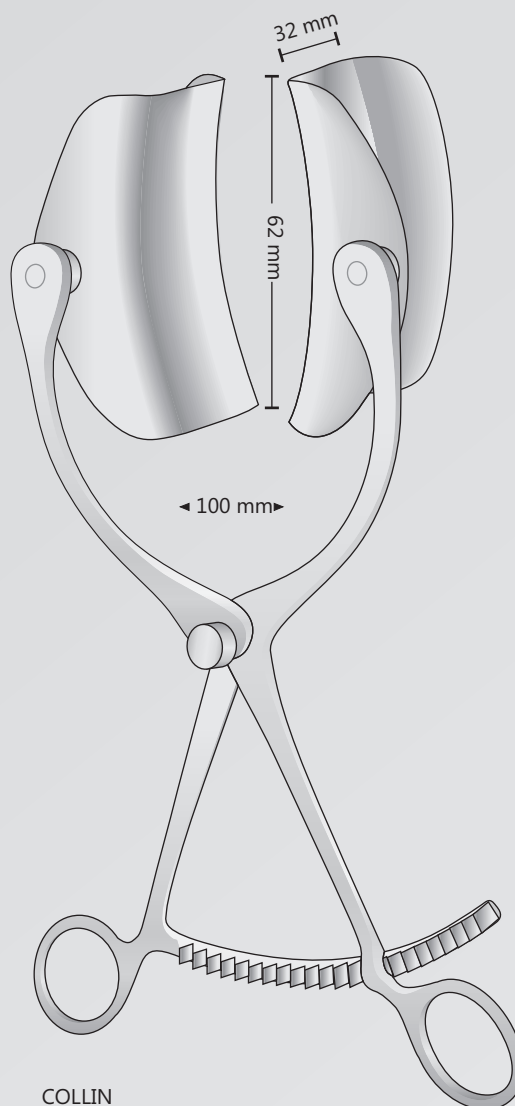

COLLIN

BV-145

220 mm

Bauchdeckenhalter
Abdominal retractors
Divaricatori addominali
Separadores abdominales
Ecarteurs Abdominaux



MEYERDING
BT-97/BT-99

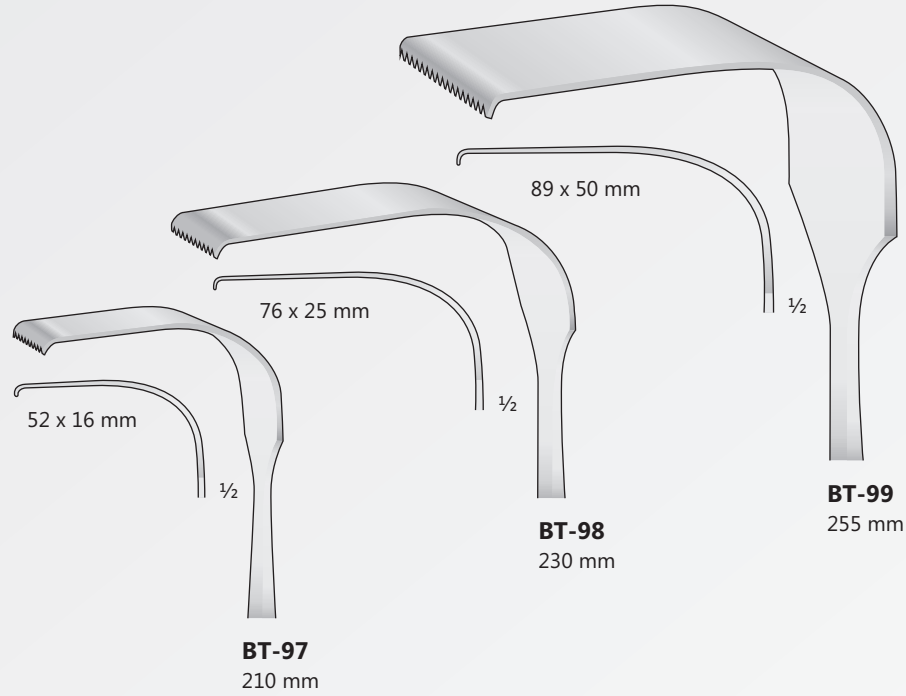

BT-97
210 mm

BT-98
230 mm

BT-99
255 mm



BV-150
170 mm

BV-152
200 mm

BV-151
230 mm

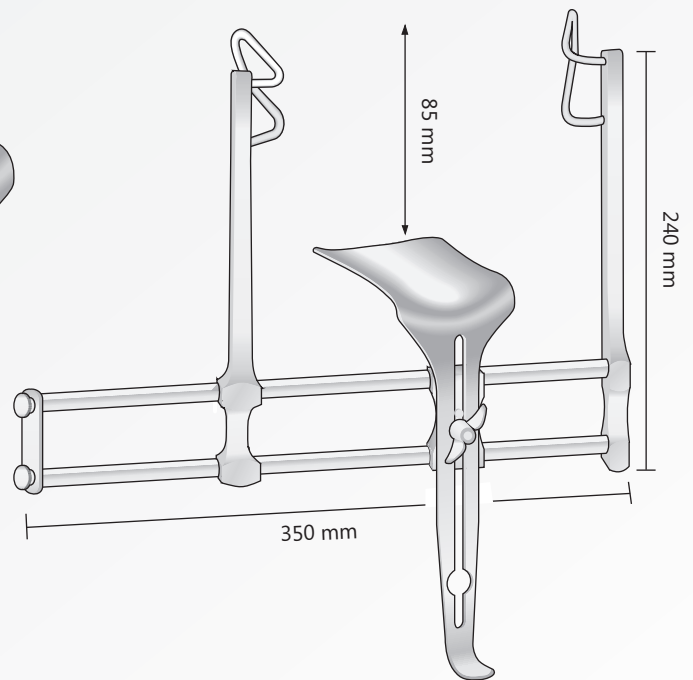

BALFOUR MODIF.
BV-46

Bauchdeckenhalter
Abdominal retractors
Divaricatori addominali
Separadores abdominales
Ecarteurs Abdominaux

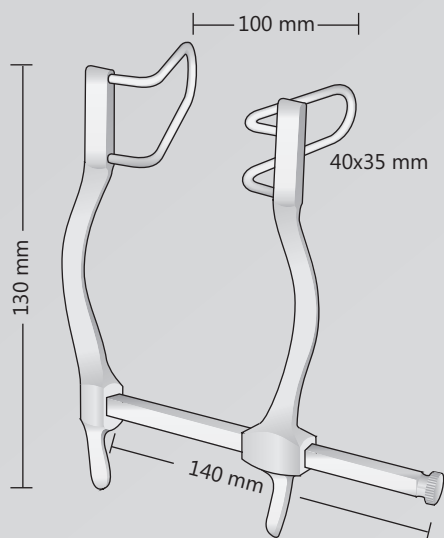

GOSSET
BV-31

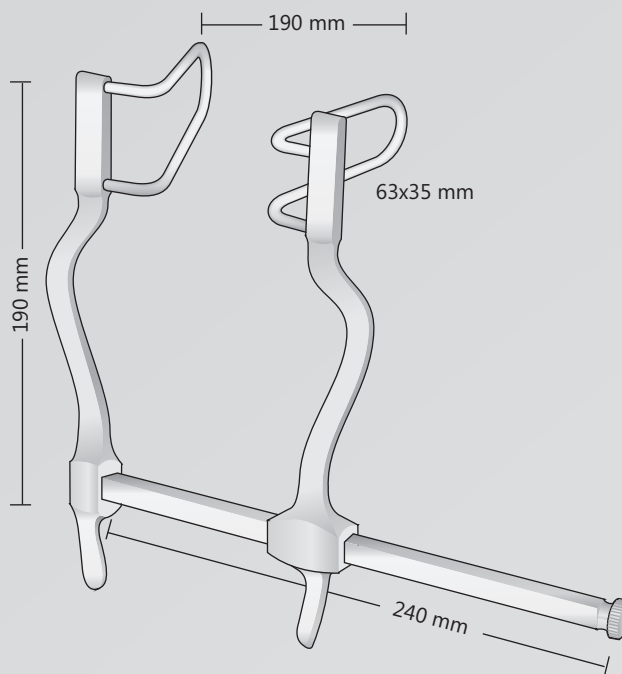

GOSSET
BV-30

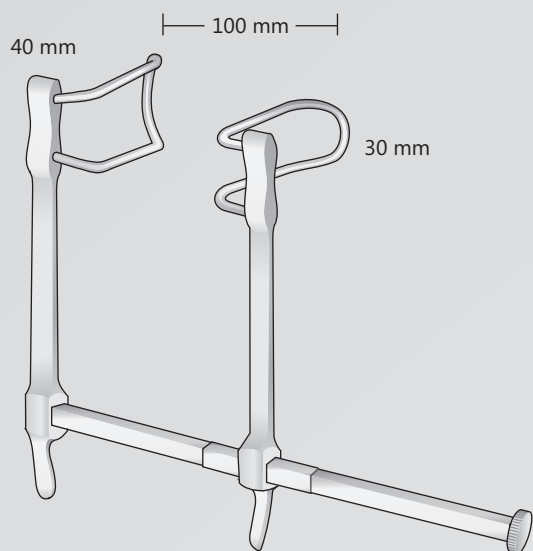

GOSSET
BV-33

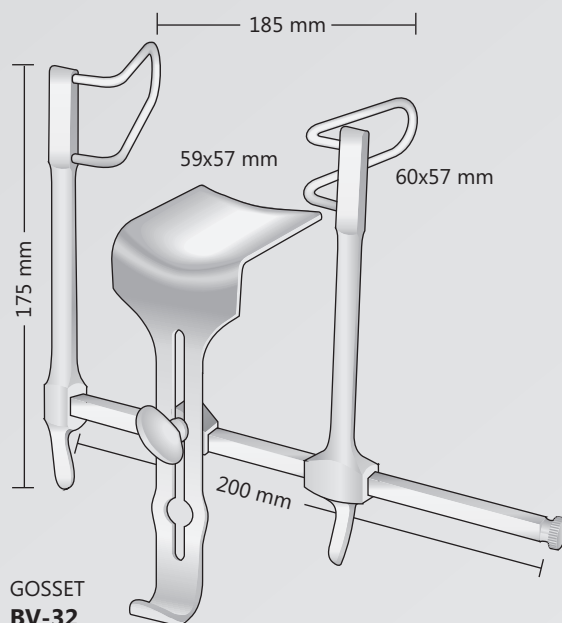

GOSSET
BV-32

Bauchdeckenhalter
Abdominal retractors
Divaricatori addominali
Separadores abdominales
Ecarteurs Abdominaux

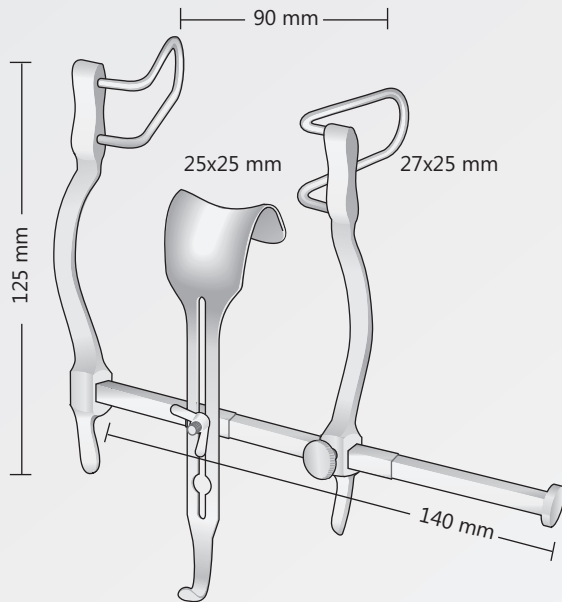

BALFOUR-BABY
BV-41

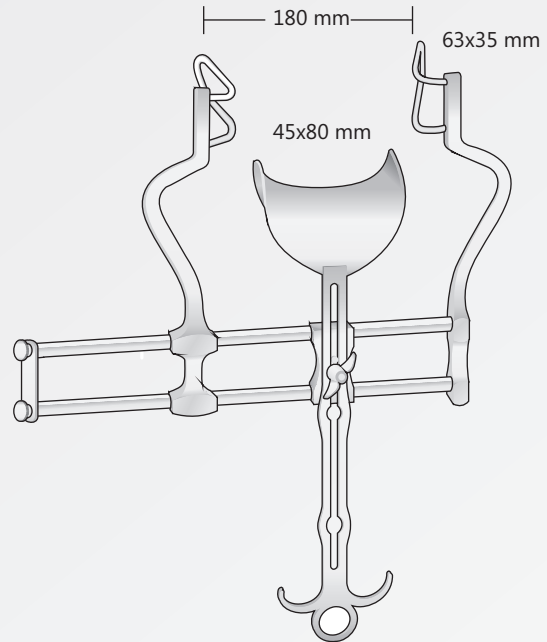

BALFOUR
BV-40

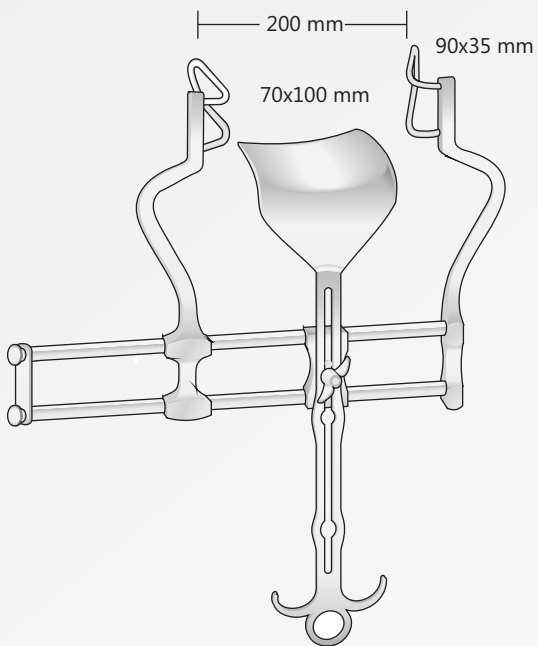

BALFOUR
BV-42

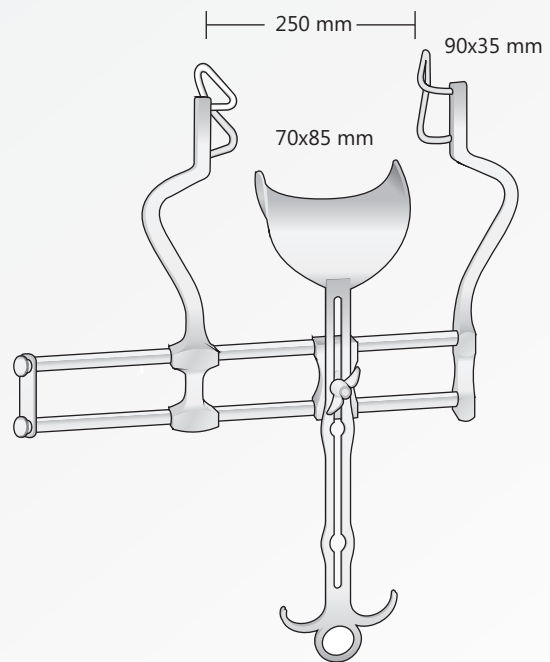

BALFOUR
BV-43

Neurochirurgie
Neuro Surgery
Neuro Chirurgia
Neuro Cirugia
Neuro Chirurgie

Schraubendreher
Screw Driver
Cacciavite
Destornillador
Tournevis



CASPAR
FF-206
200 mm

Spezialbohrer
Special Drill
Punta speciale
Taladro especial
Perceuse spéciale

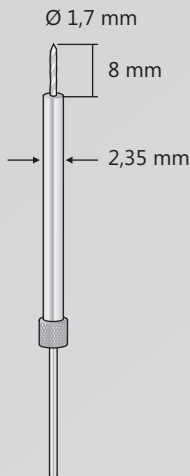

CASPAR
FF-203
145 mm

Distraktionsschrauben
Distraction Screw
Viti da distrazione
Tornillos de distracción
Vis de distraction

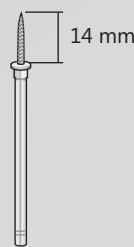

CASPAR
FF-204
70 mm

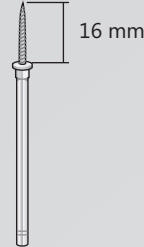

CASPAR
FF-205
70 mm

CASPAR
FF-190

Distraktor komplett rechts
Distractor complete right
Distrattore completo destro

FF-191 1 Distraktor allein - 1 Distractor only

FF-192 1 Bohrbüchse - 1 Drilling Guide

FF-203 1 Spezialbohrer - 1 Special Drill

FF-205 2 Distraktionsschrauben - 2 Distraction Screws

FF-206 1 Schraubendreher - 1 Screw Driver

CASPAR
FF-200M

Distraktor Lang komplett
Distractor Long complete

Distrattore modificato completo

FF-201M 1 Distraktor Lang allein - 1 Distractor Long only

FF-202 1 Bohrbüchse - 1 Drilling Guide

FF-203 1 Spezialbohrer - 1 Special Drill

FF-205 2 Distraktionsschrauben - 2 Distraction Screws

FF-206 1 Schraubendreher - 1 Screw Driver

Bohrbüchse rechts, Allein
Drilling Guide right, Only
Guida punte destro, solo
Drill Guide à droite, seule
Guía de taladro derecho, sólo

Bohrbüchse Allein
Drilling Guide only
Guida punte solo
Guía de taladro sólo
Guide de perçage seulement

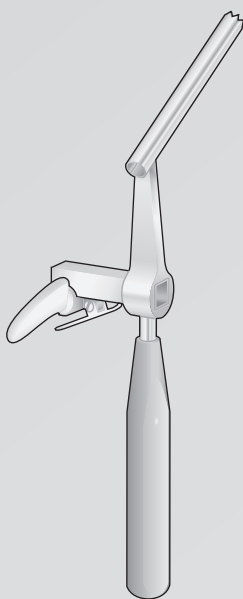

FF-192

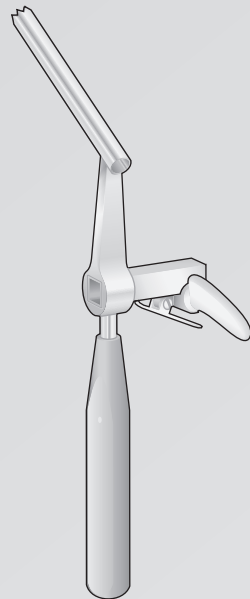

FF-202

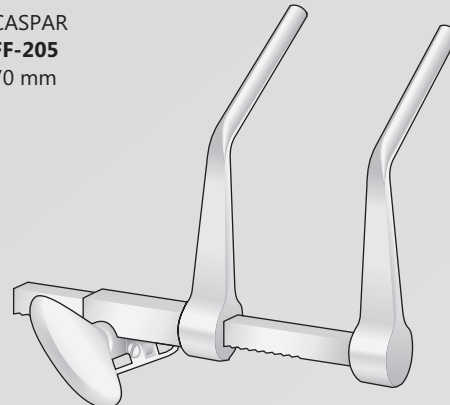

Distraktor rechts, Allein
Distractor right, Only
Distrattore destro, solo
Distractor derecho, sólo
Distracteur droite seule

CASPAR
FF-191

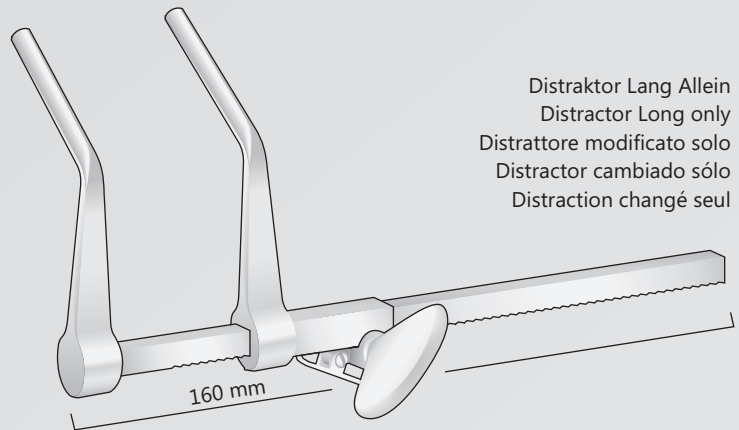

Distraktor Lang Allein
Distractor Long only
Distrattore modificato solo
Distractor cambiado sólo
Distraction changé seul

CASPAR
FF-201M



BONTEMPI
CHIRURGISCHE INSTRUMENTE

Elevatori, Raspatori e Cucchiali

Raspatorien
Periosteal Raspatories
Periostotomi
Legras periostotomos
Rugines à periostomie

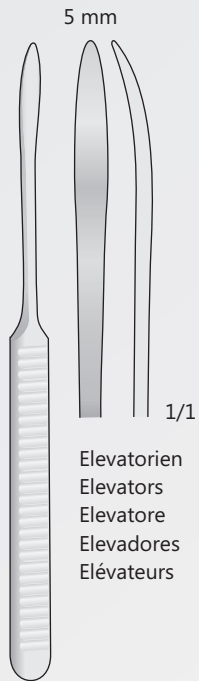

WILLIGER
WG-10
165 mm

Elevatorien
Elevators
Elevatore
Elevadores
Elévateurs

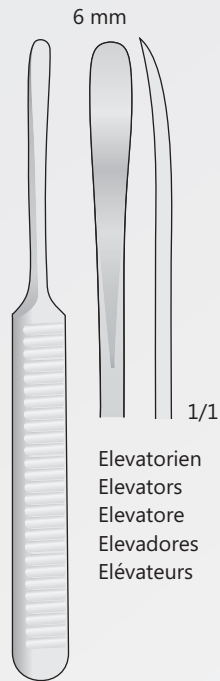

WILLIGER
WG-12
160 mm

Elevatorien
Elevators
Elevatore
Elevadores
Elévateurs

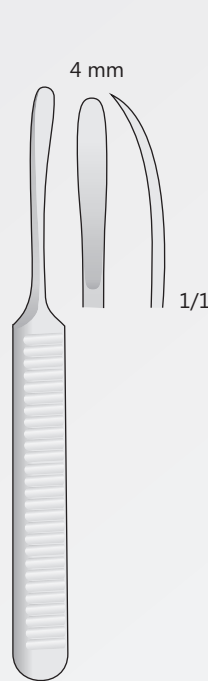

WILLIGER
WG-14
140 mm

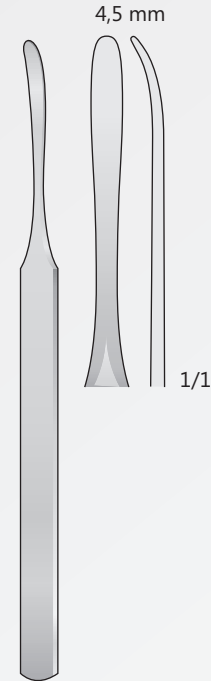

KÖNIG
KO-1
155 mm

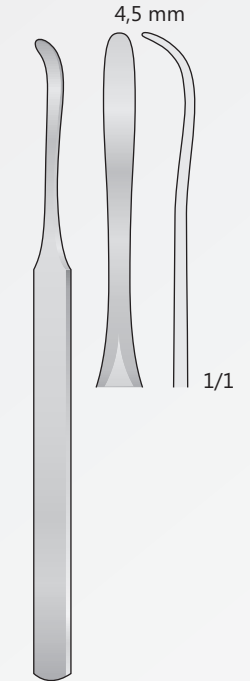

KÖNIG
KO-2
155 mm

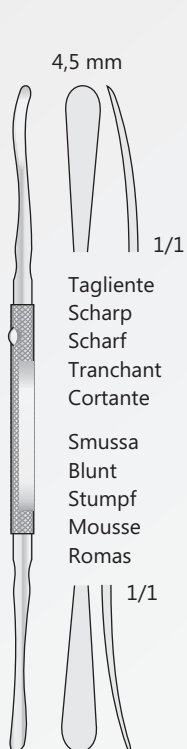

FREER
180 mm

Tagliente
Scharf
Scharf
Tranchant
Cortante

Smussa
Blunt
Stumpf
Mousse
Romas

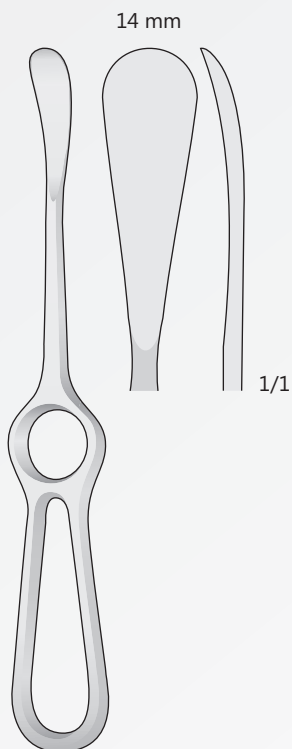

SEDILLOT
BT-37
210 mm

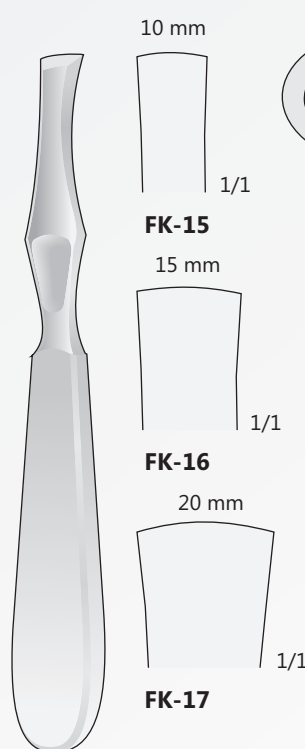

LAMBOTTE
FK-15/FK-17
205 mm

FK-15

FK-16

FK-17

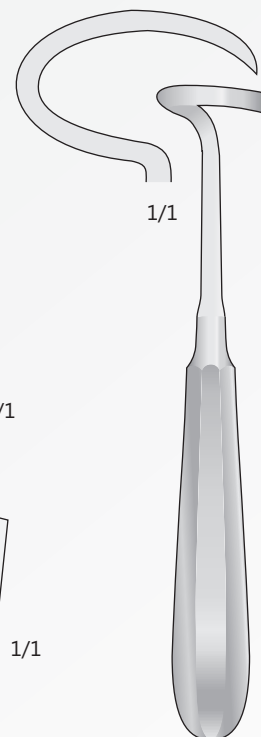

DOYEN
FK-18
180 mm

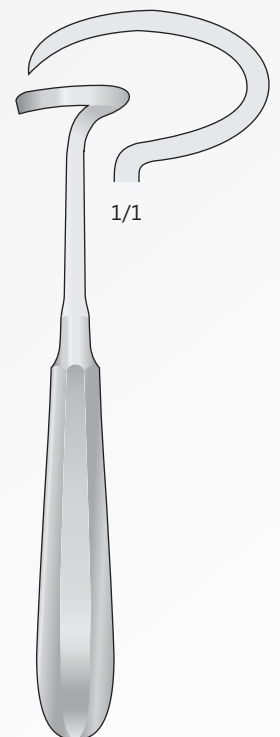

DOYEN
FK-19
180 mm

Raspatorien
Periosteal Raspatories
Periostotomi
Legras periostotomos
Rugines à periostomie

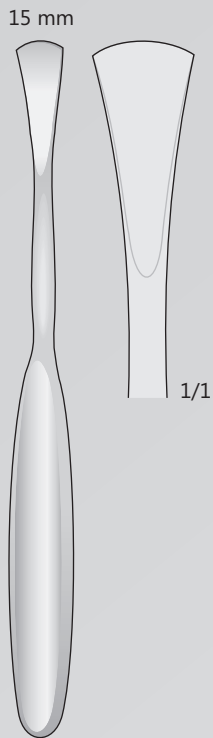

CUSHING
FK-252
190 mm

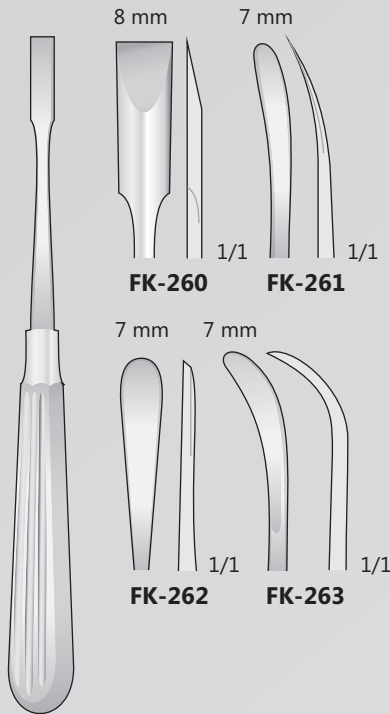

ADSON
FK-260/FK-263
170 mm

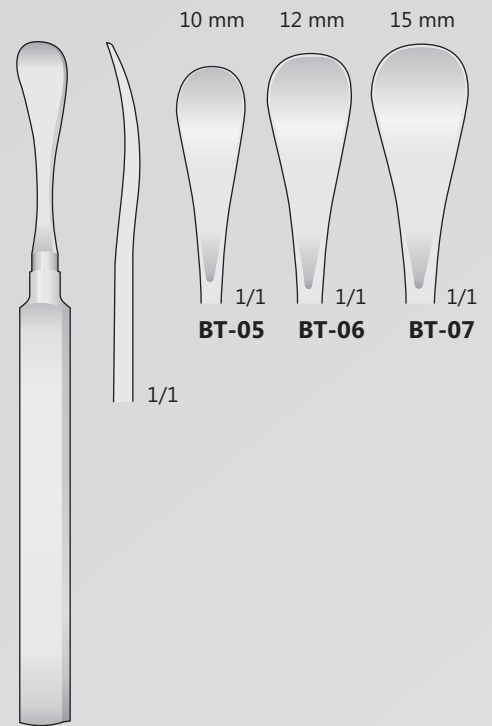

HENAHAN
BT-05/BT-07
175 mm

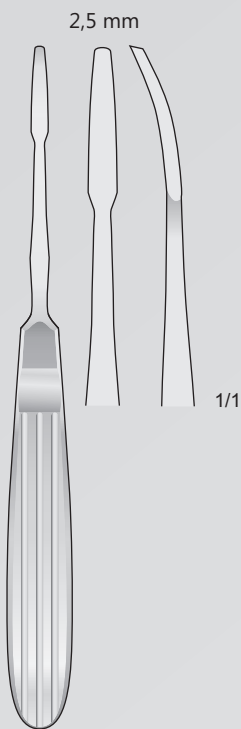

JOSEPH
FK-80
170 mm



JOSEPH
FK-82
180 mm



FK-234
180 mm

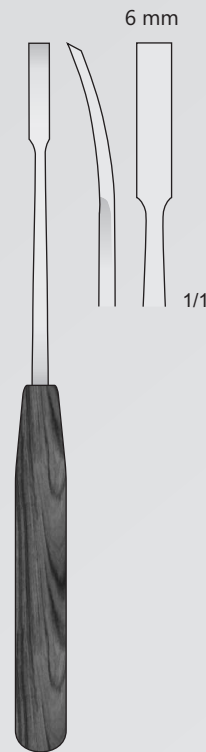

FK-230
190 mm

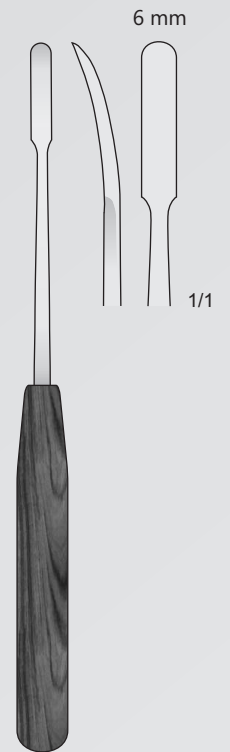

FK-232
190 mm

Raspatorien
Periosteal Raspatories
Periostotomi
Legras periostotomos
Rugines à periostomie

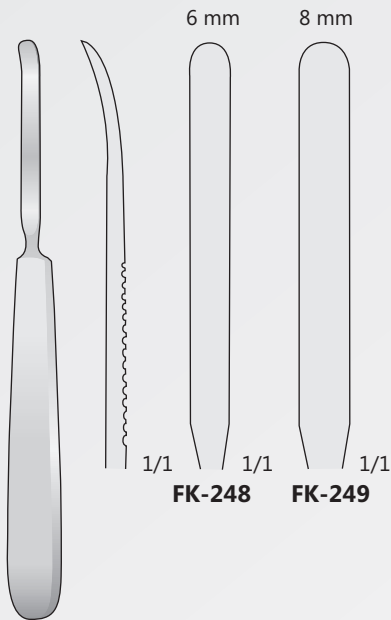

FK-248/FK-249
170 mm

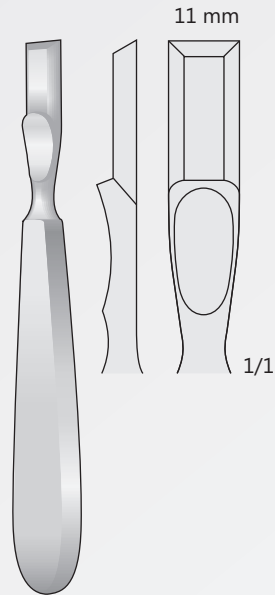

**FARABEUF-COLLIN
FK-247**
160 mm

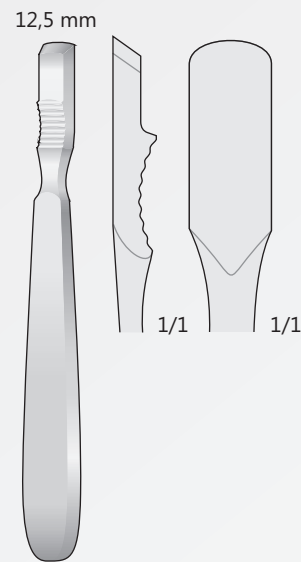

**FARABEUF
FK-250**
150 mm

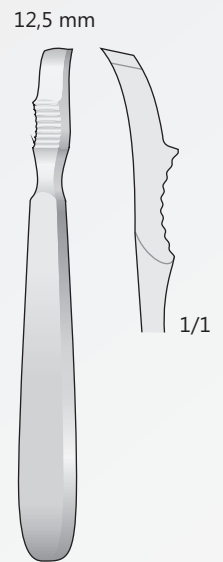

**FARABEUF
FK-251**
150 mm

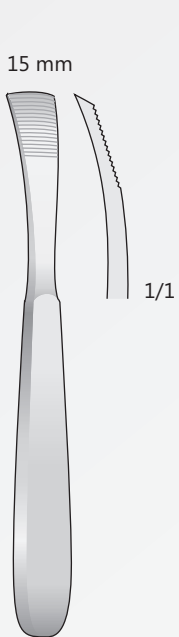

**JANSEN
FK-255**
165 mm

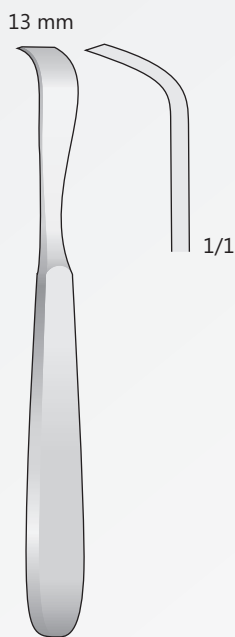

**SCHNEIDER
FK-258**
175 mm

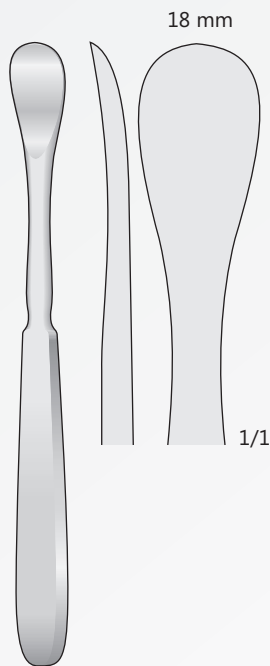

**SEDILLOT
FK-254**
185 mm

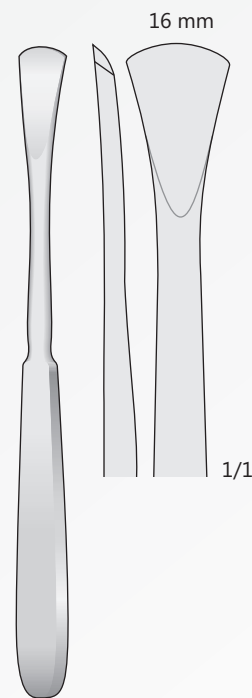

**LANGENBECK
FK-256**
190 mm

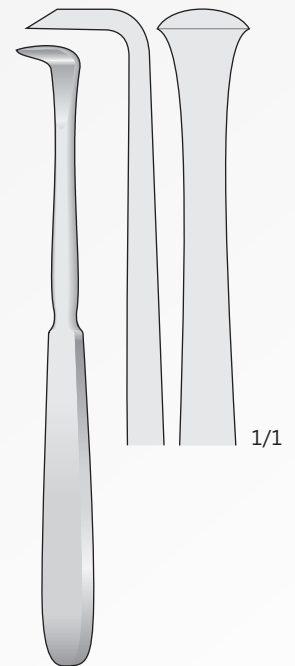

**LANGENBECK
FK-257**
180 mm

Knochenhebel
Bone Levers
Leve per ossa
Elevadores para huesos
Leviers à os

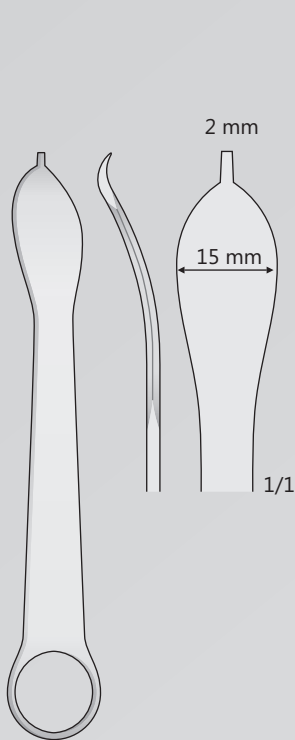

FK-45
120 mm

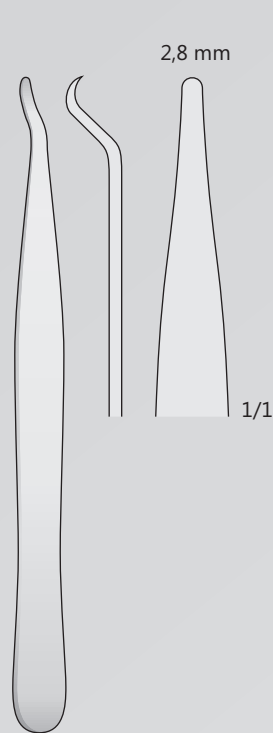

FK-46
140 mm

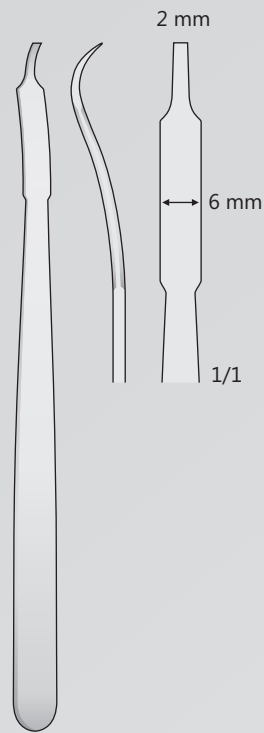

MINI-HOHMANN
FK-48
160 mm

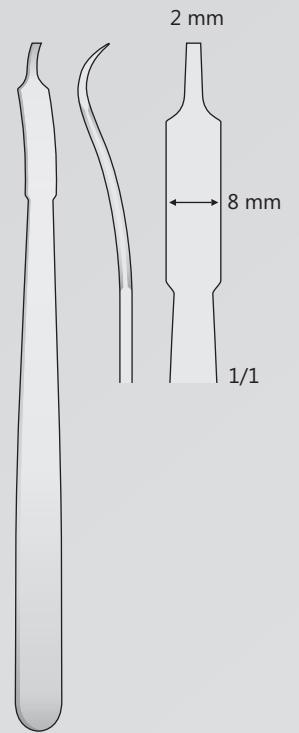

MINI-HOHMANN
FK-49
160 mm

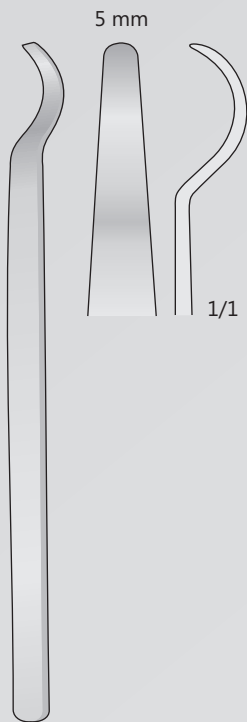

FK-30
150 mm

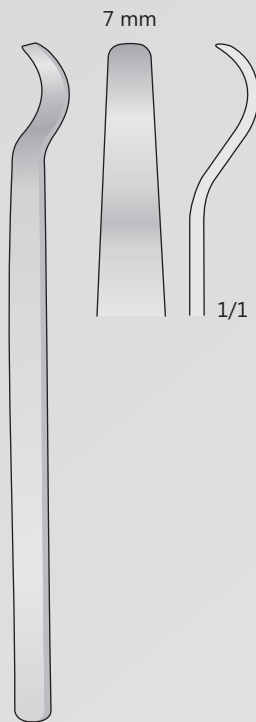

FK-28
150 mm

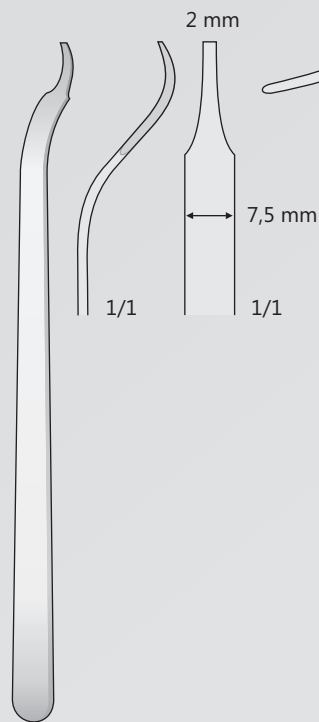

BUCK-GRAMCKO
FK-20
150 mm

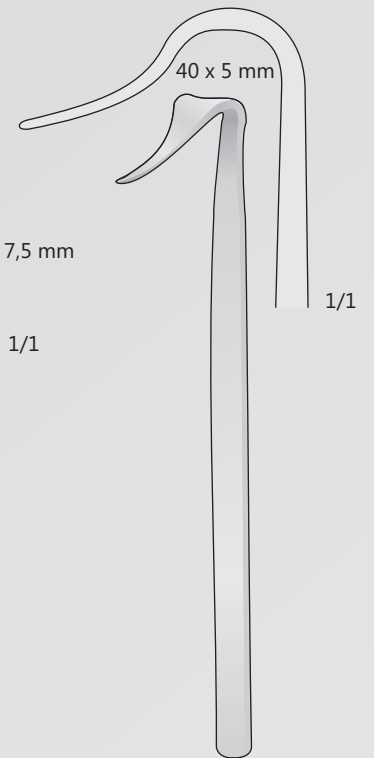

BLOUNT
FK-27
175 mm

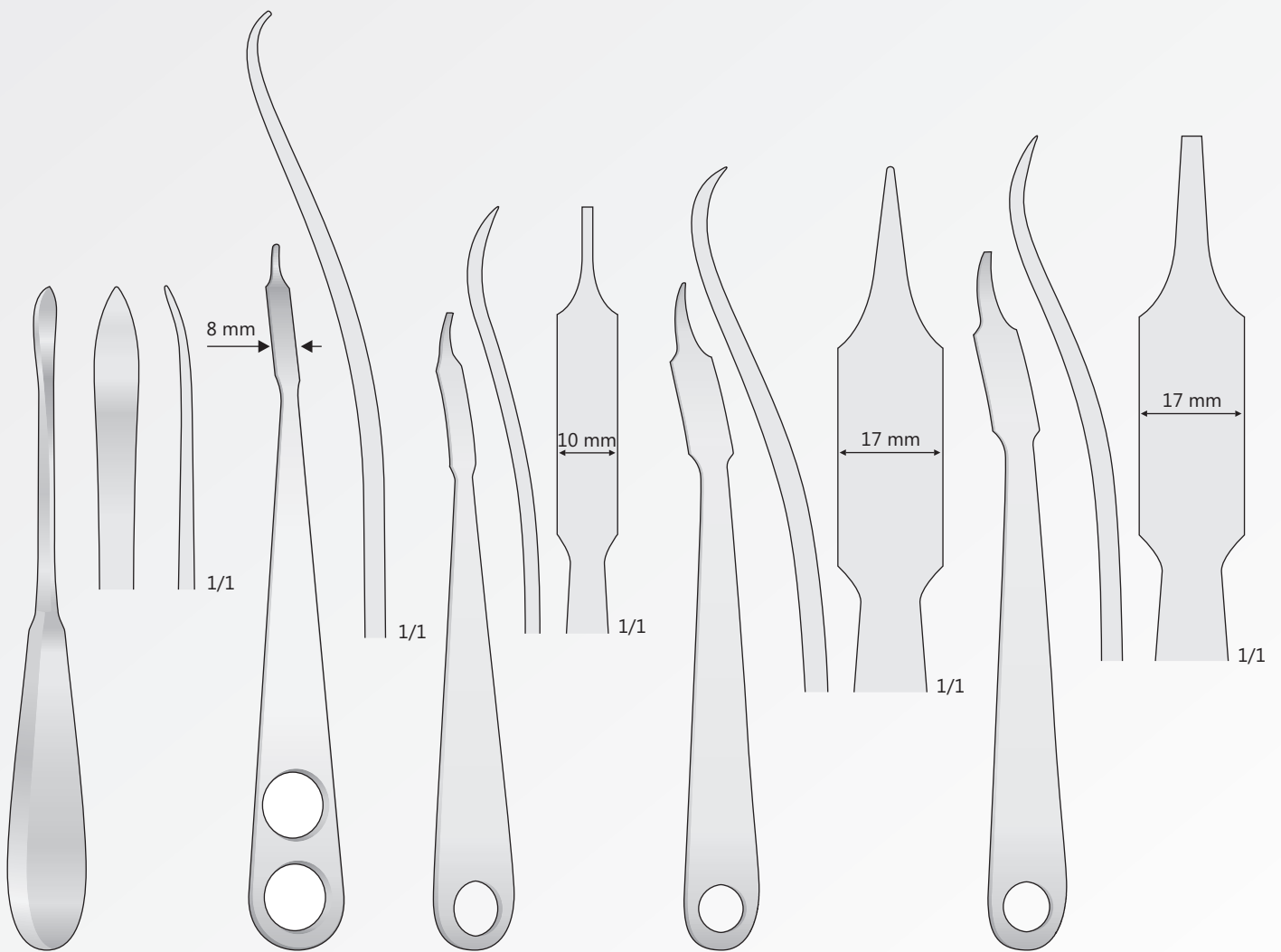

LANGENBECK
FK-12
200 mm

HOHMANN
FK-133
225 mm

FK-51
220 mm

FK-52
240 mm

FK-53
240 mm

Knochenhebel
Bone Levers
Leve per ossa
Elevadores para huesos
Leviers à os

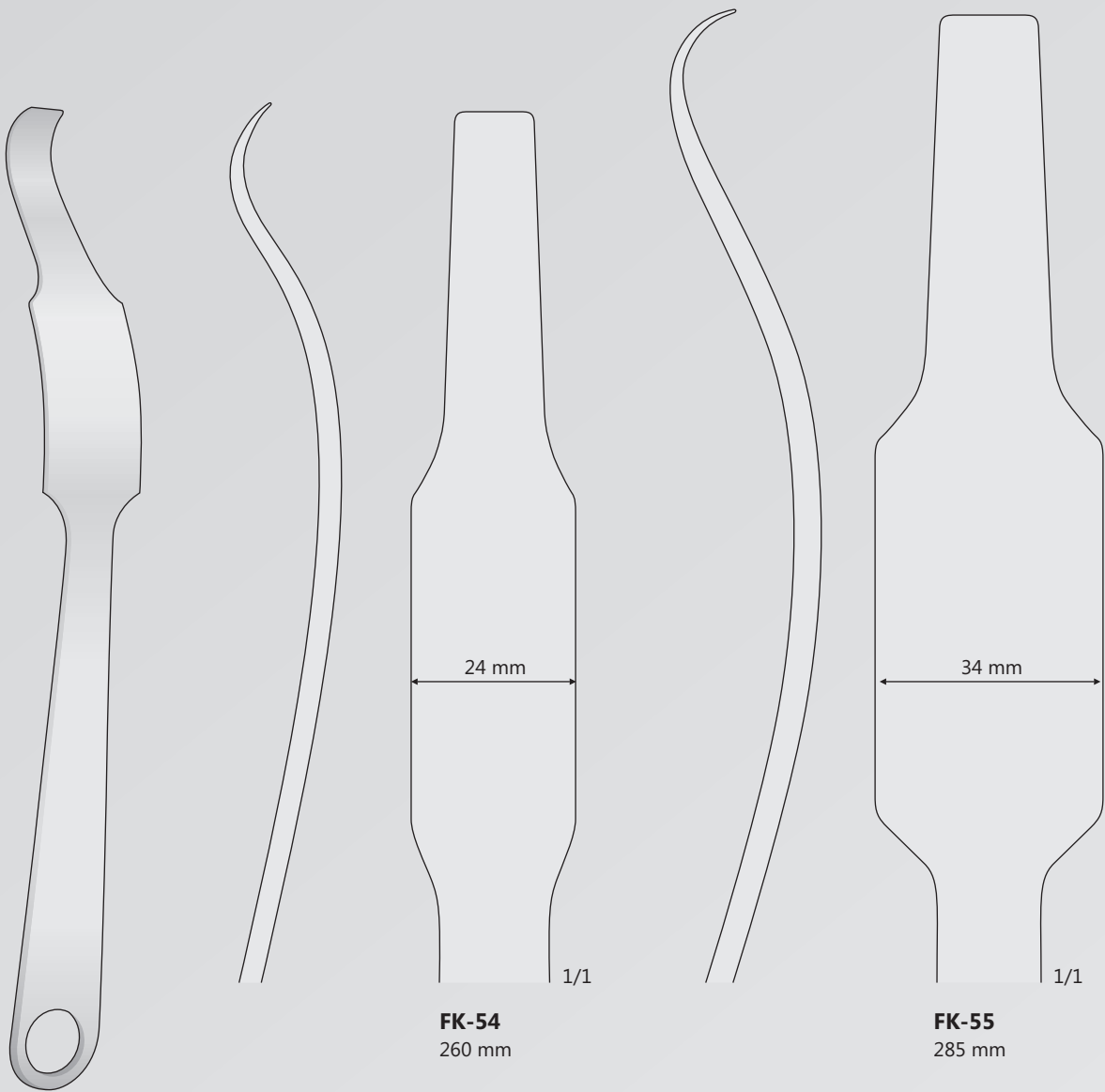

HOHMANN
FK-54/FK-55

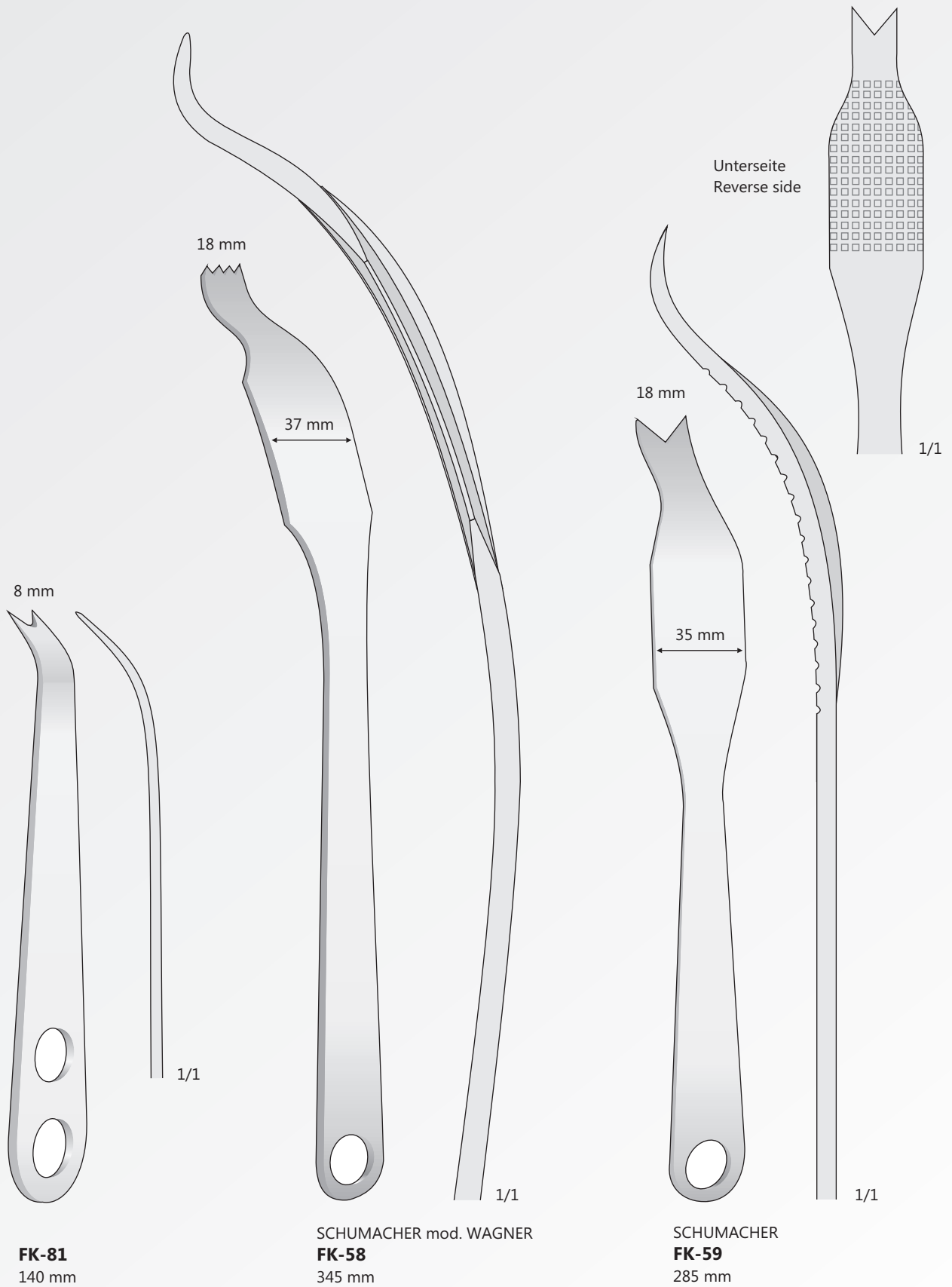

Knochenhebel
Bone Levers
Leve per ossa
Elevadores para huesos
Leviers à os

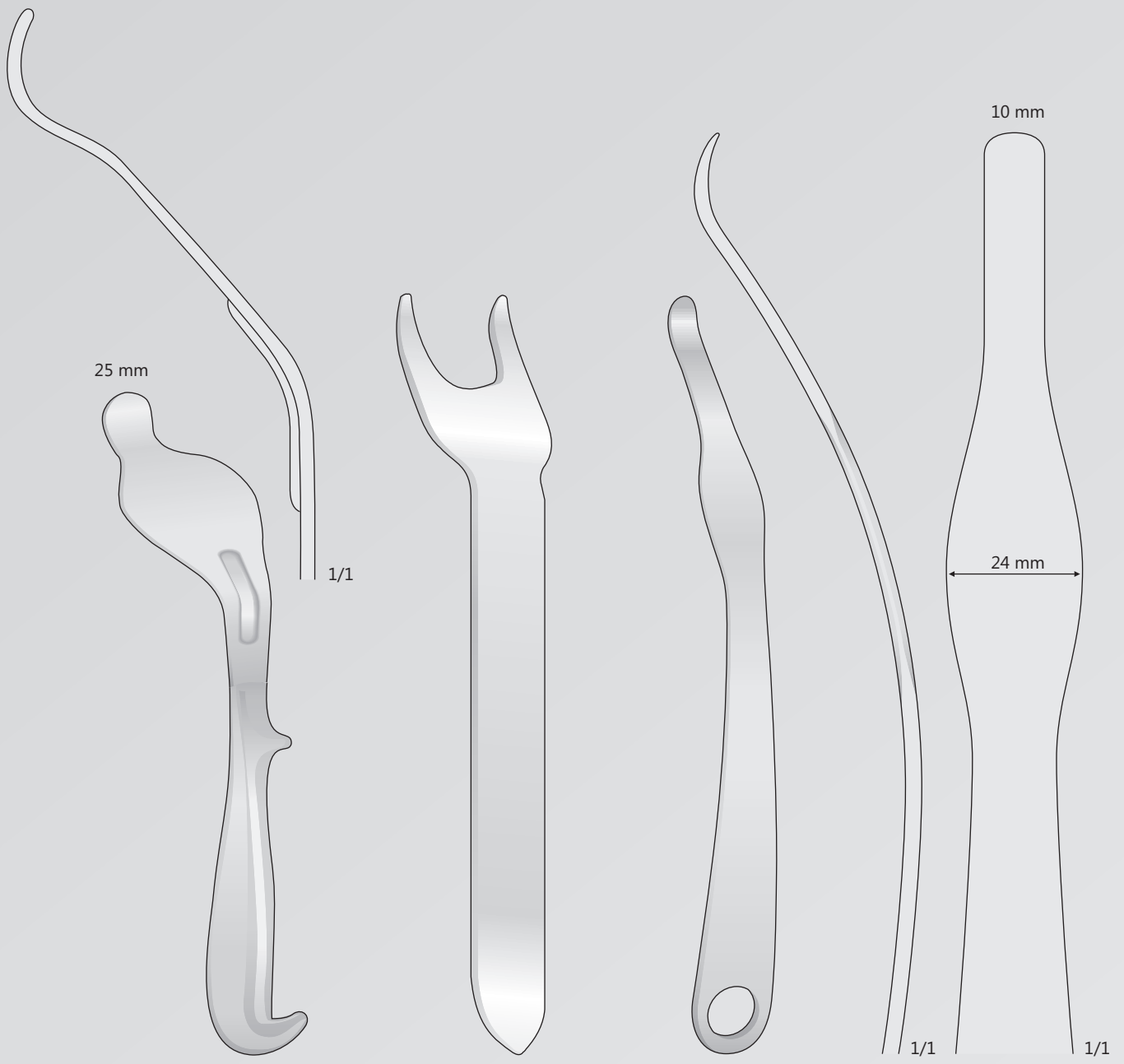

BENNETT
FK-176 43 mm
FK-179 60 mm
240 mm

BLOUNT
FK-93
260 mm

FK-56
260 mm

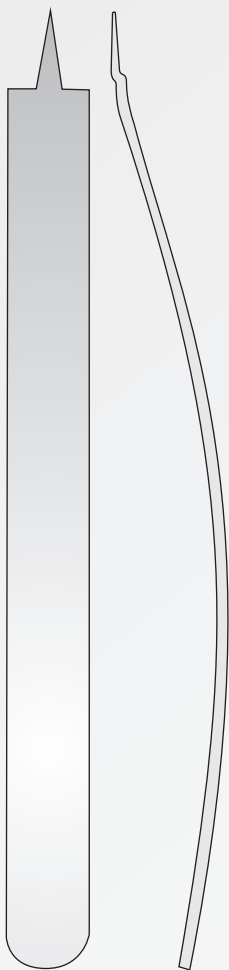

FK-164
250 mm

Spinalhaken
Spinal Retractors
Divaricatore spinale
Separadores espinales
Ecarteurs spinaux

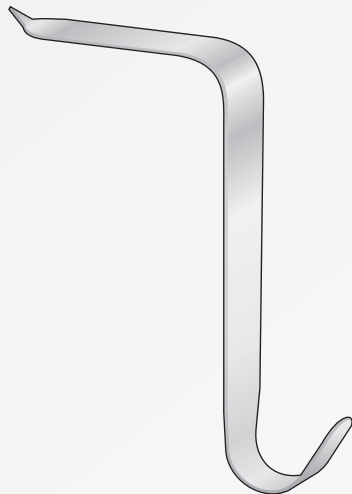

FK-168 75 x 30 mm
FK-169 100 x 30 mm
165 mm

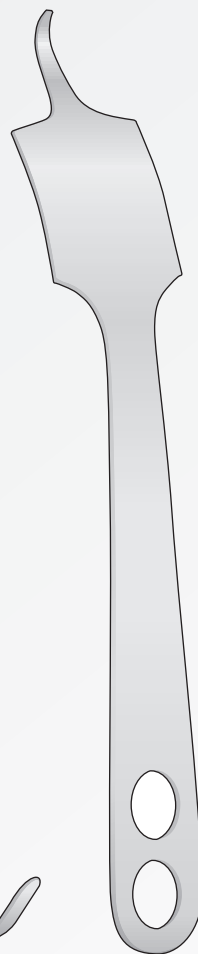

HOHMANN
FK-47/FK-57
240 mm

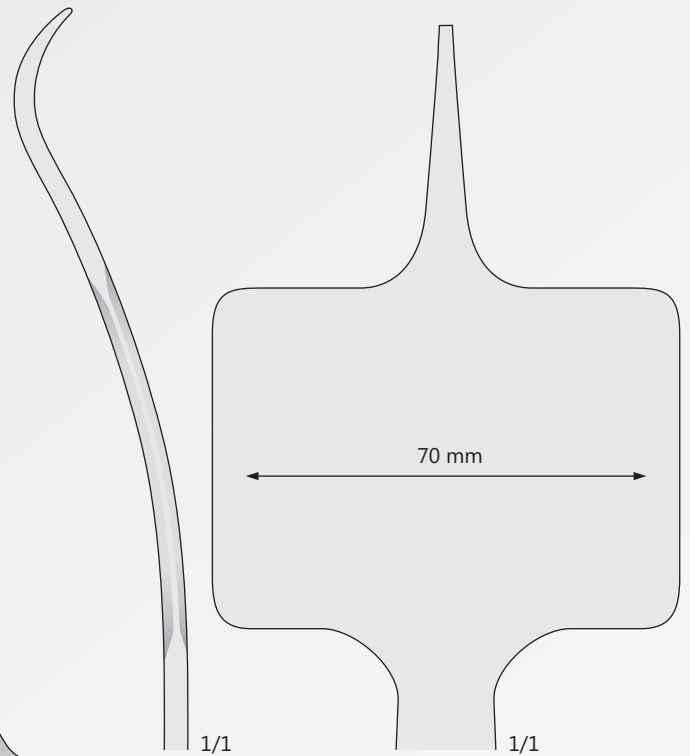

70 mm

FK-47
240 mm

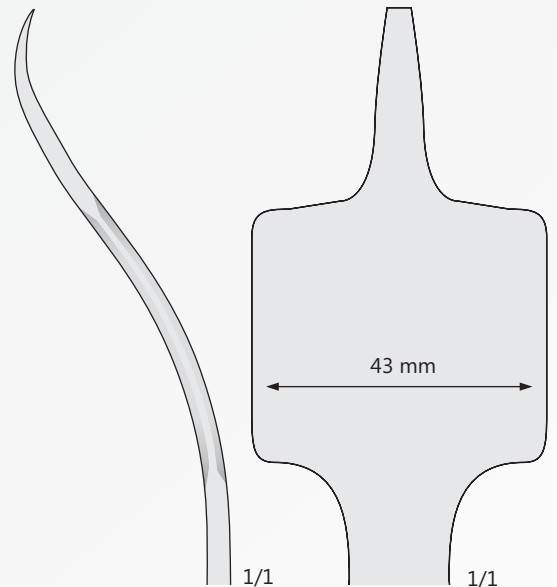

43 mm

FK-57
240 mm

Scharfe Löffel
Sharp curettes
Curette, Cucchiai taglienti
Cucharillas cortantes
Curettes tranchantes

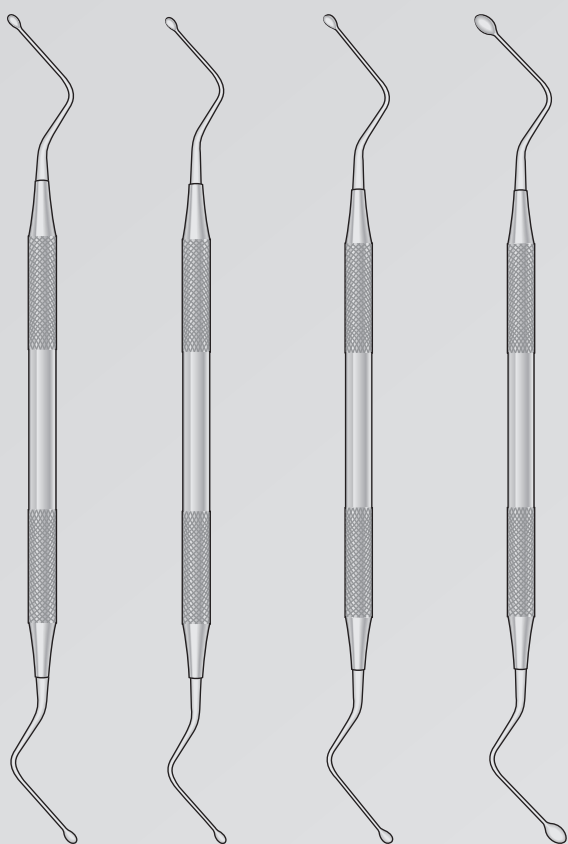

HEMINGWAY C-1 175 mm
HEMINGWAY C-2 175 mm
HEMINGWAY C-3 175 mm
HEMINGWAY C-4 175 mm

Fig. 1

Fig. 2

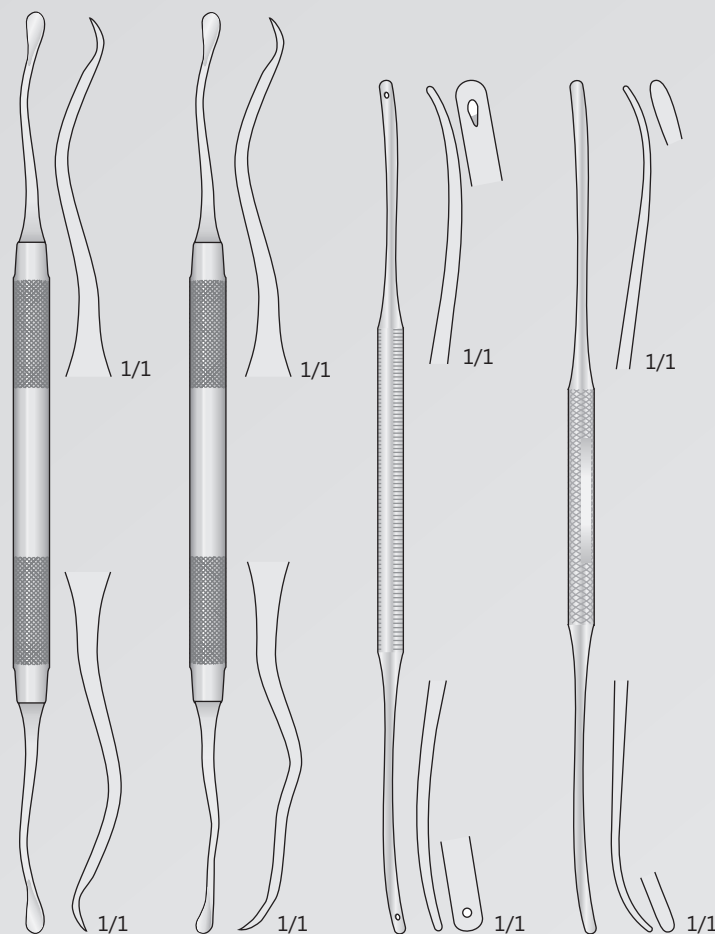

SL-1
200 mm

SL-2
195 mm

KO-16
180 mm

OLIVECRONA KO-47
180 mm

Scharfe Löffel
Sharp curettes
Curette, Cucchiai taglienti
Cucharillas cortantes
Curettes tranchantes



MARTINI
FK-70
140 mm

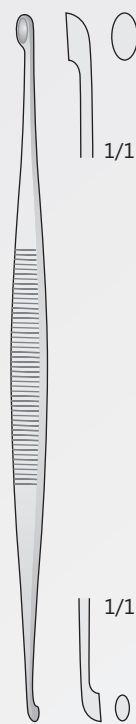

WILLIGER
FK-71
145 mm

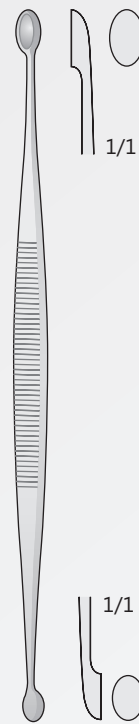

JACOBSON
FK-75
140 mm

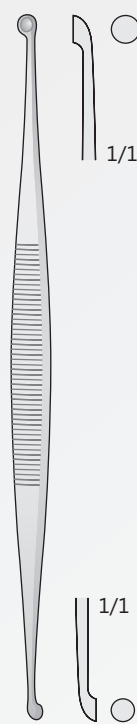

MARTINI
FK-76
140 mm



JANSEN
FK-77
160 mm

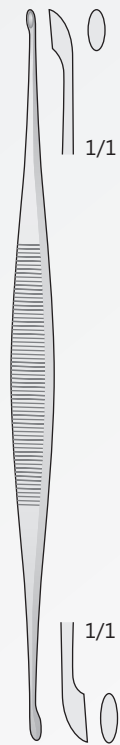

BARTH
FK-78
180 mm

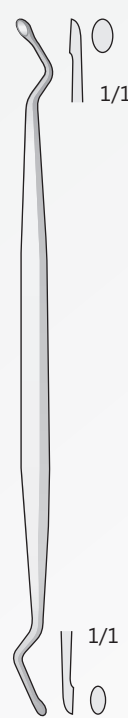

FK-83
160 mm

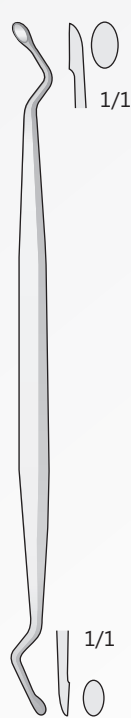

JANSEN
FK-84
160 mm

Scharfe Löffel
Sharp curettes
Curette, Cucchiali taglienti
Cucharillas cortantes
Curettes tranchantes

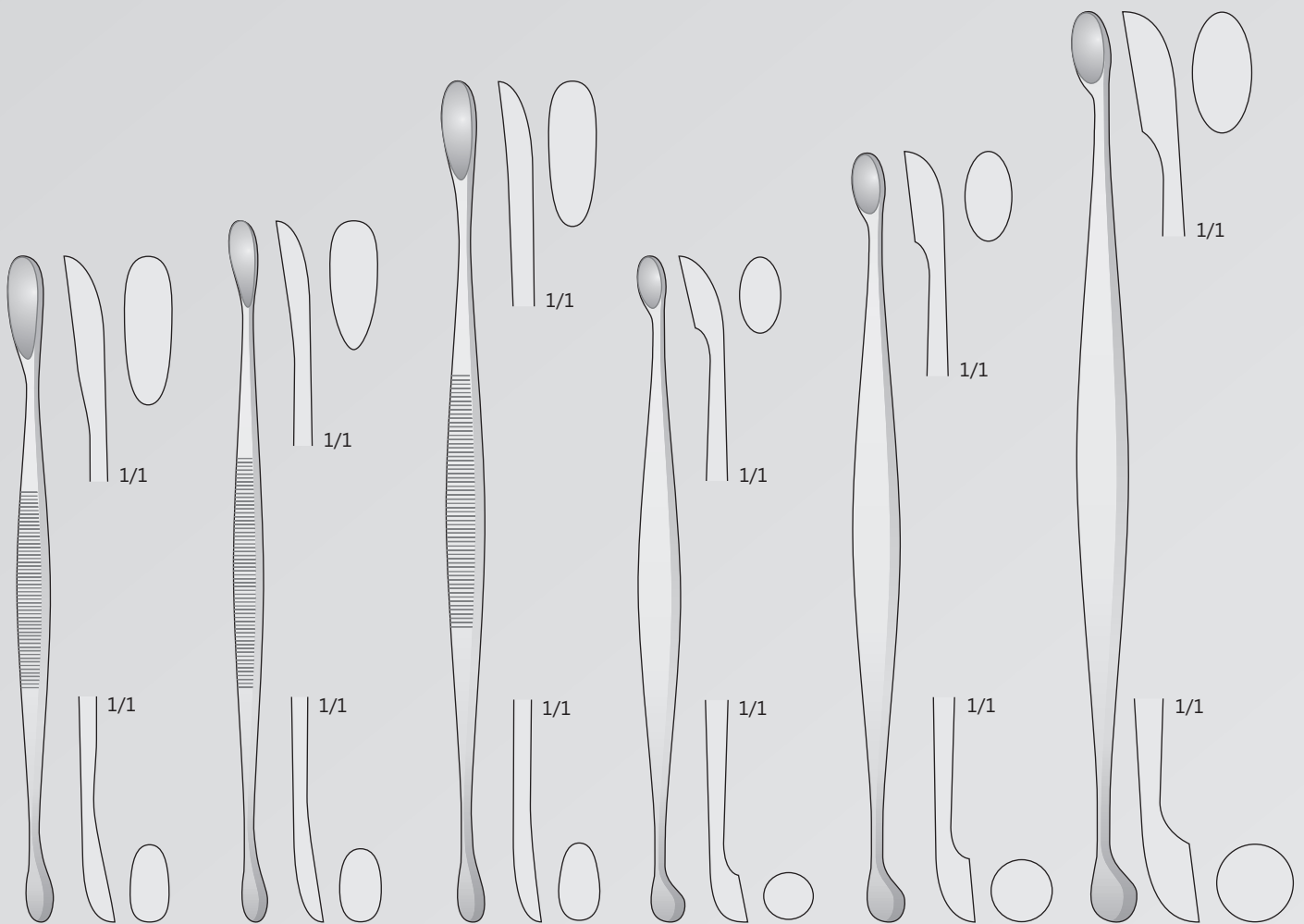

VOLKMANN
FK-79
130 mm

VOLKMANN
FK-72
145 mm

VOLKMANN
FK-73
170 mm

FK-177
130 mm

FK-74
160 mm

FK-178
200 mm

Scharfe Löffel
Sharp curettes
Curette, Cucchiali taglienti
Cucharillas cortantes
Curettes tranchantes

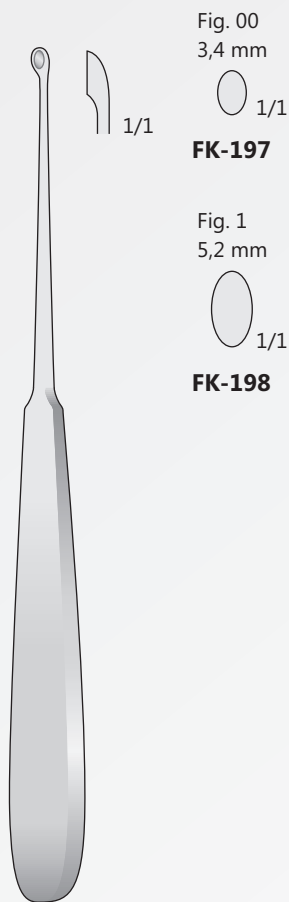

WILLIGER
FK-197/FK-198
170 mm

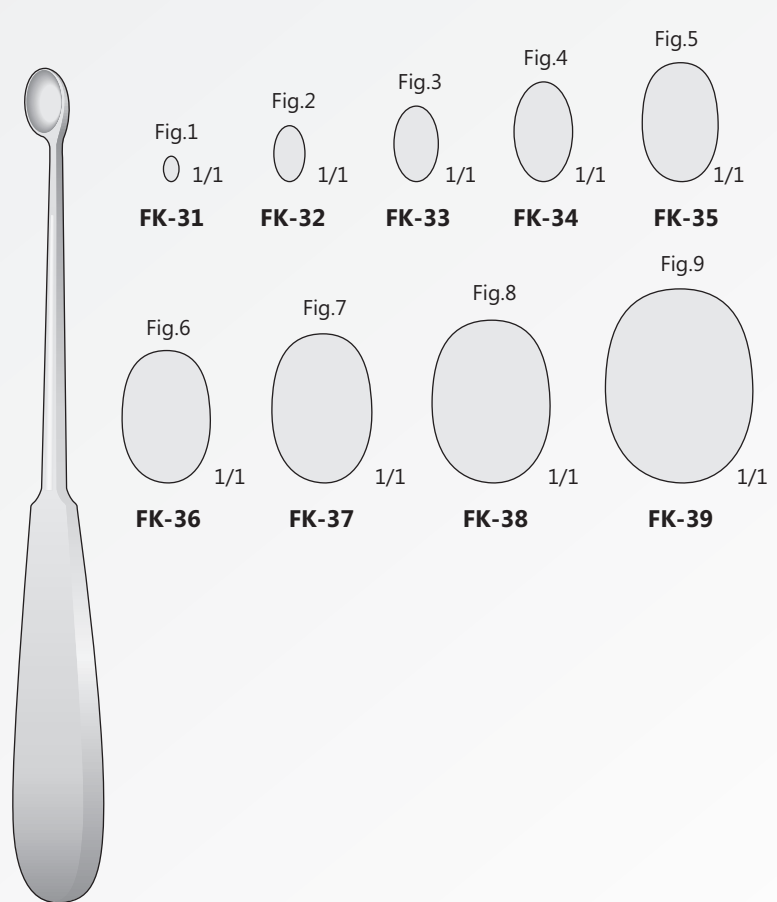

FK-31/FK-39
210 mm

Scharfe Löffel
Sharp currettes
Curette, Cucchiali taglienti
Cucharillas cortantes
Currettes tranchantes

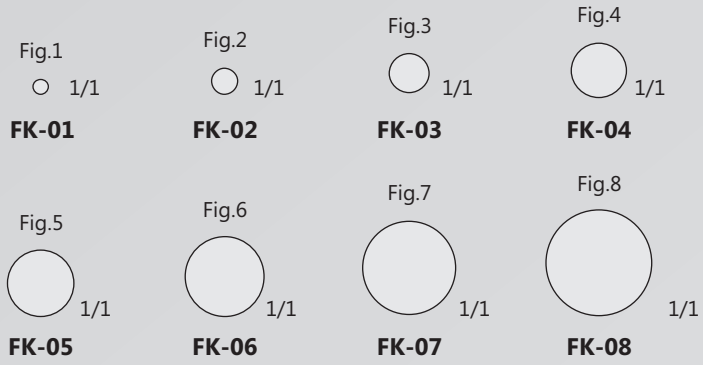

FK-01/FK-08
180 mm

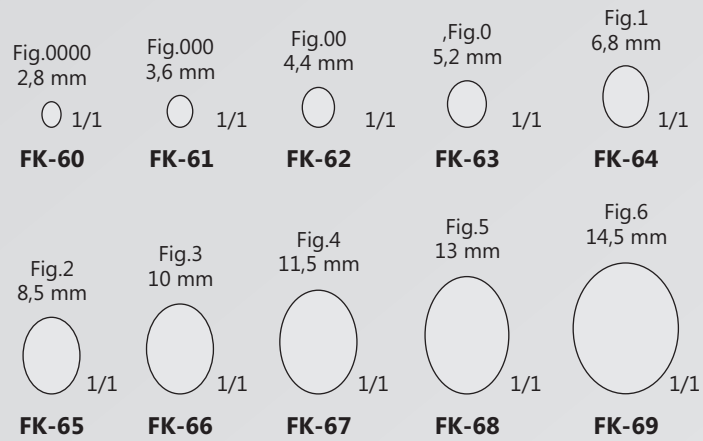
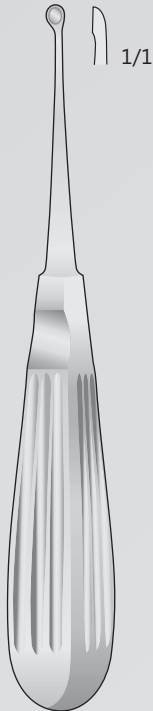

VOLKMANN
FK-60/FK-69
170 mm

Scharfe Löffel
Sharp curettes
Curette, Cucchiali taglienti
Cucharillas cortantes
Curettes tranchantes

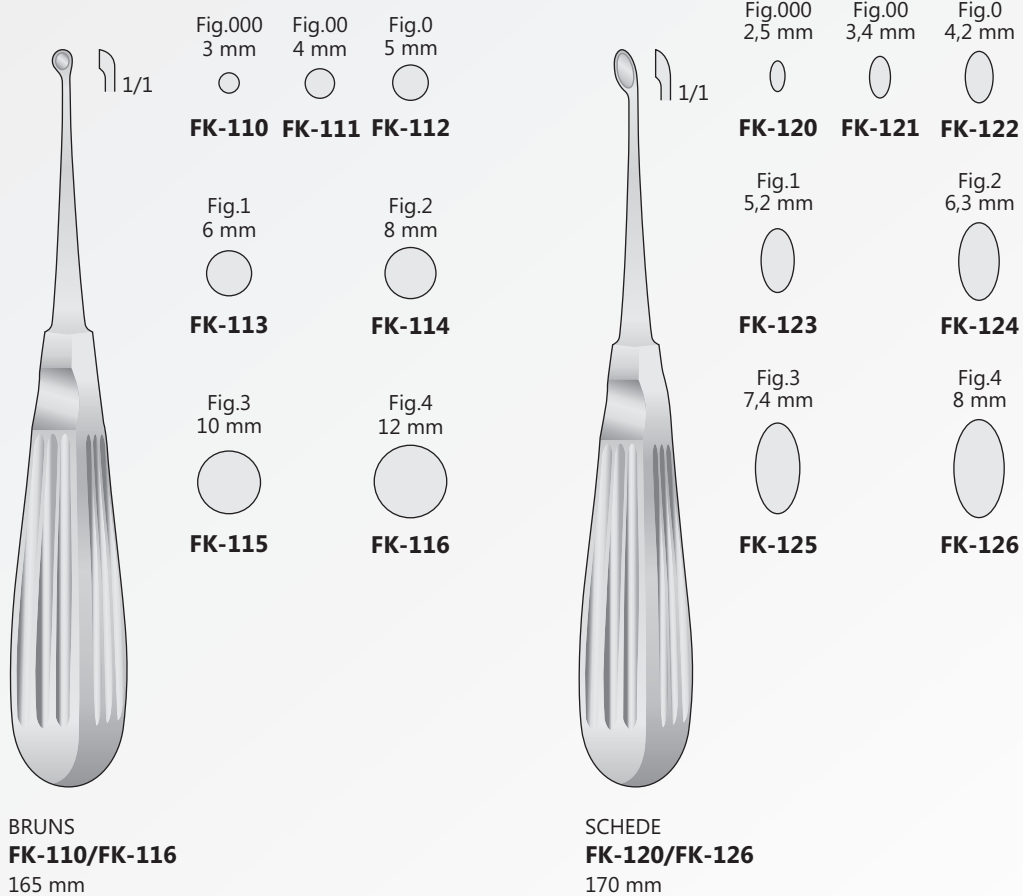

Raspatorien
Raspatories
Periostotomi
Legras
Rugines

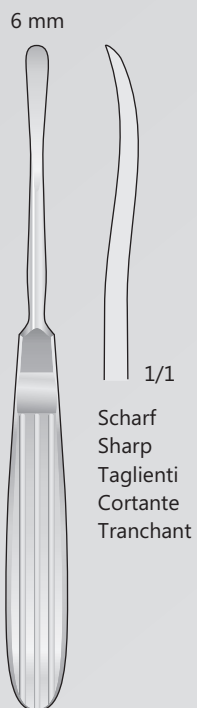

OBWEGESER
DO-59
175 mm

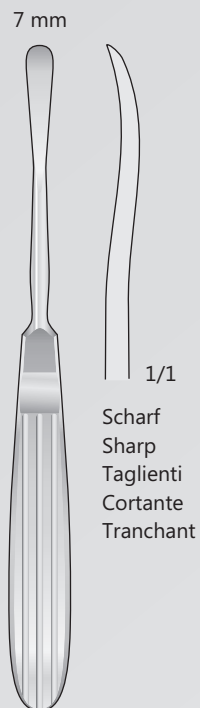

OBWEGESER
DO-63
175 mm

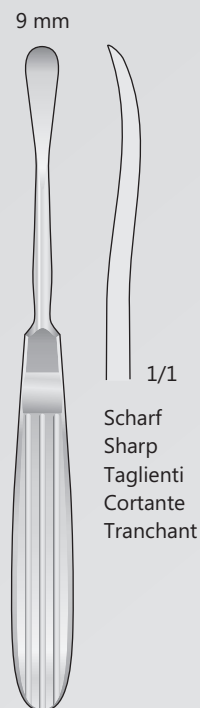

OBWEGESER
DO-67
175 mm

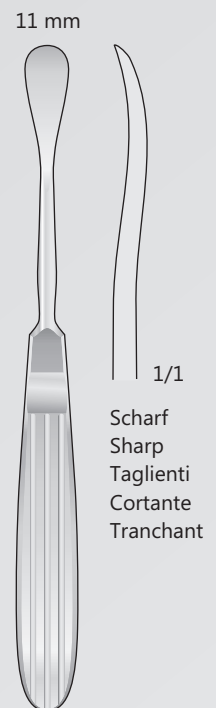

OBWEGESER
DO-65
175 mm



BONTEMPI
CHIRURGISCHE INSTRUMENTE

Hohlmeisselzangen, Laminektomie-Zangen
Bone rongeurs, Laminectomy Rongeurs
Pinze ossivore, Laminotomi
Pinzas-Gubias, Pinzas cortantes para laminectomia
Pinces-Gouges, Pinces emporte-pièces à laminectomie

Hohlmeißelzangen
Bone rongeurs
Pinze ossivore
Pinza-gubias
Pincas-gouges

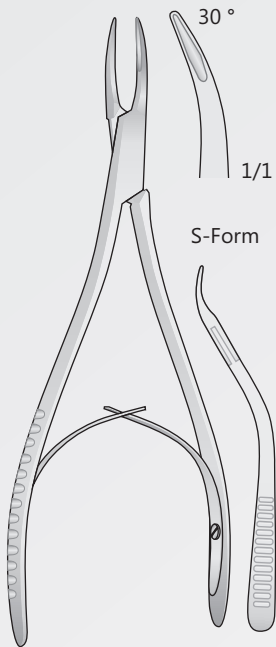

MINI-FRIEDMANN
FO-85
150 mm

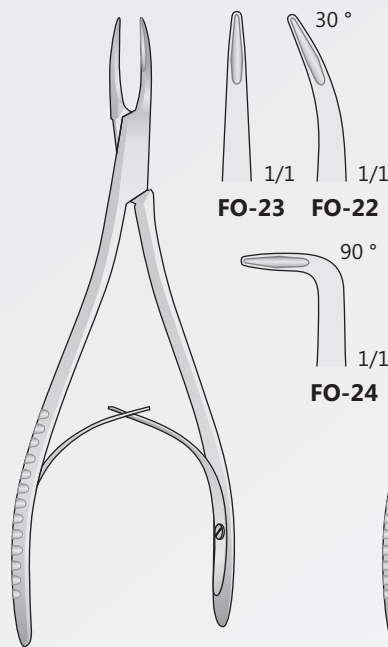

MINI-FRIEDMANN
FO-22/FO-24
150 mm

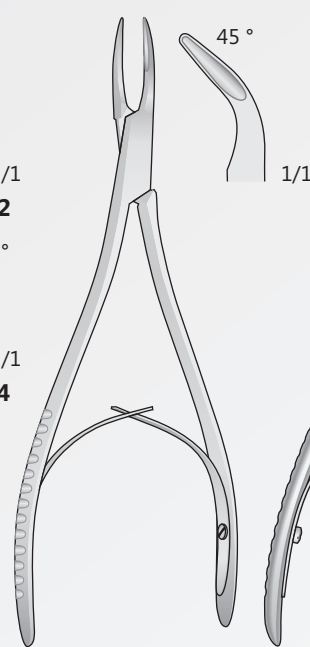

MINI-FRIEDMANN
FO-220
150 mm

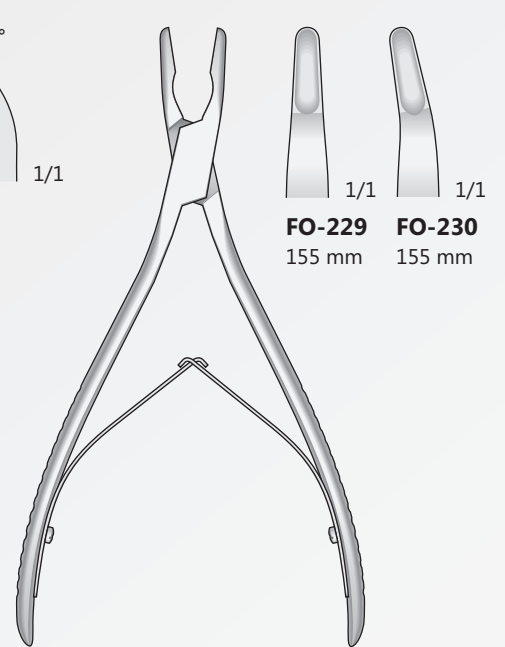

LEMPERT
FO-229/FO-230
155 mm

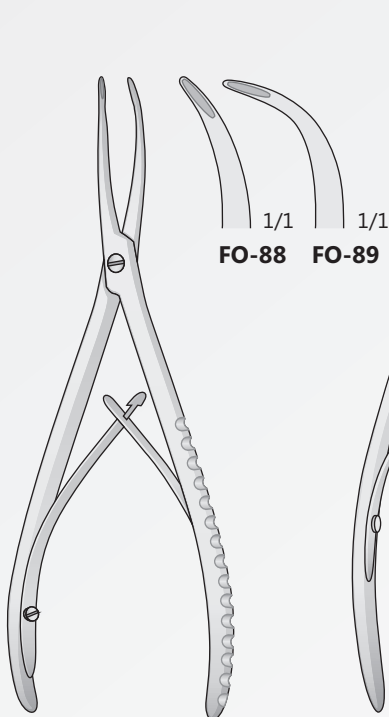

STELLBRINK
FO-88/FO-89
170 mm

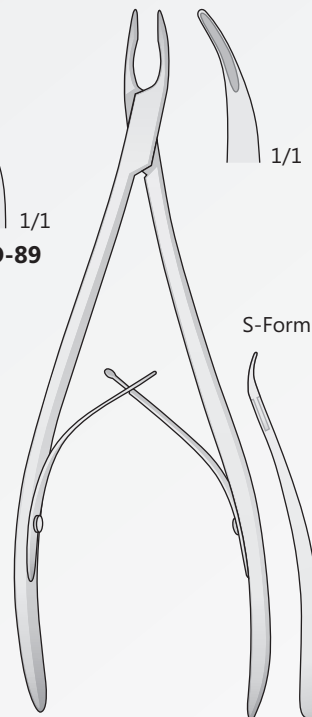

STELLBRINK
FO-87
190 mm

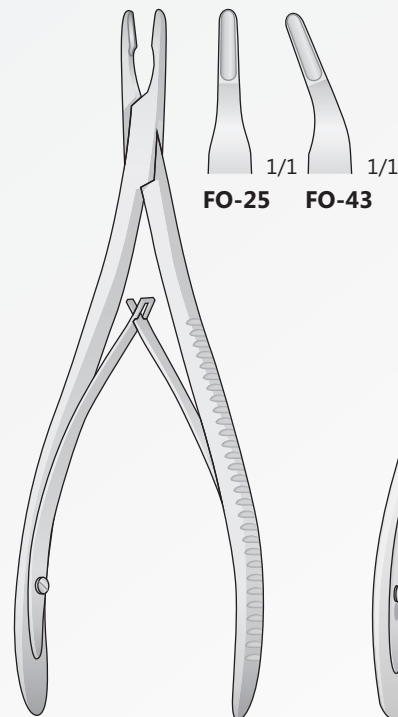

LEMPERT
FO-25/FO-43
190 mm

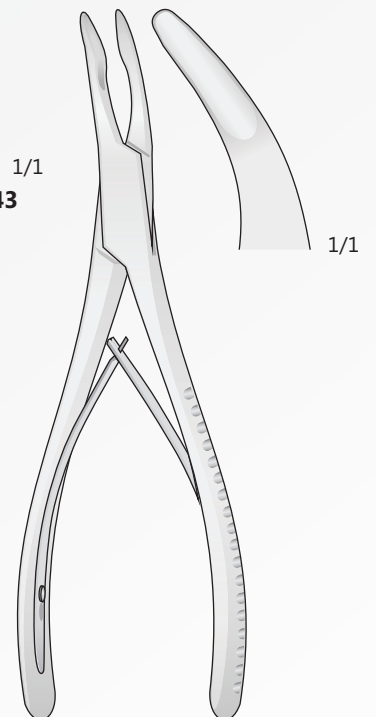

OLIVECRONA
FO-45
190 mm

Hohlmeißelzangen - Knochensplitterzangen
 Bone rongeurs - Bone cutting Forceps
 Pinze ossivore - Cesoie per ossa
 Pinza-gubias - Pinzas cortantes para huesos
 Pincas-gouges - Pincas coupantes

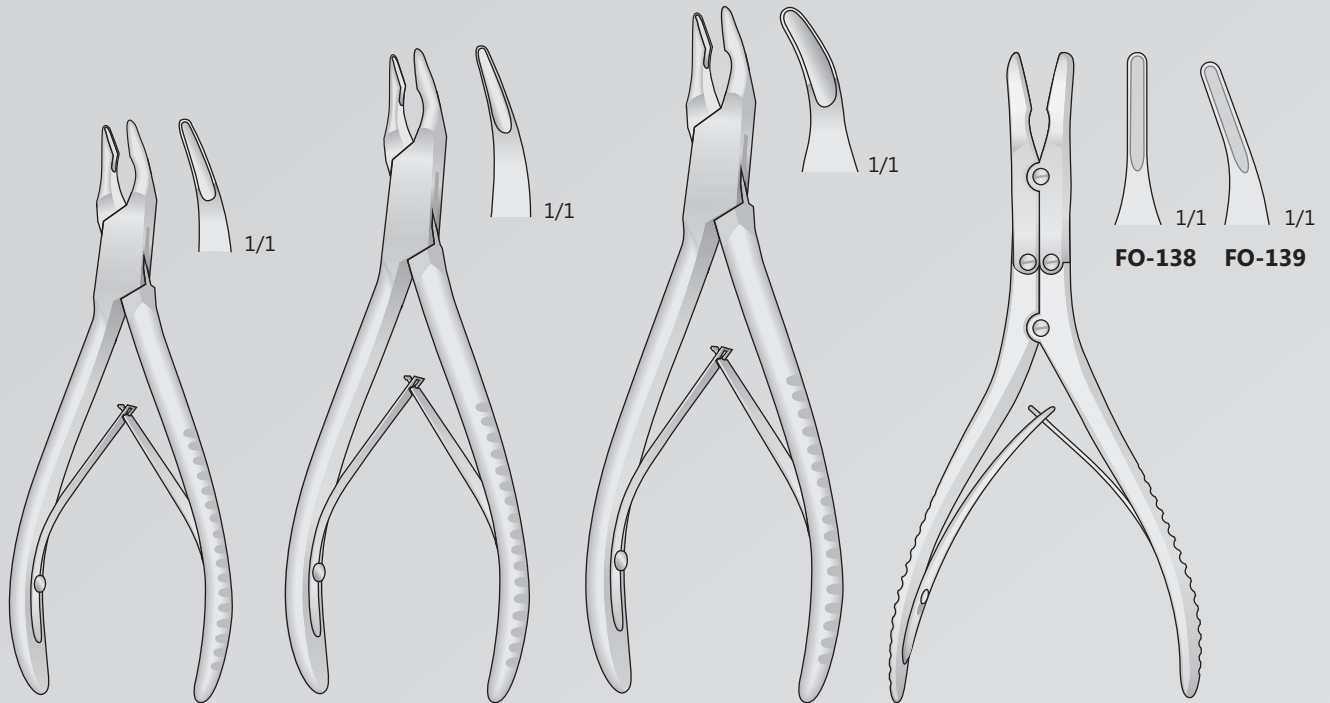

MINI FRIEDMANN
FO-15
120 mm

FRIEDMANN
FO-17
140 mm

BLUMENTHAL
FO-19
155 mm

RUSKIN
FO-138/FO-139
150 mm

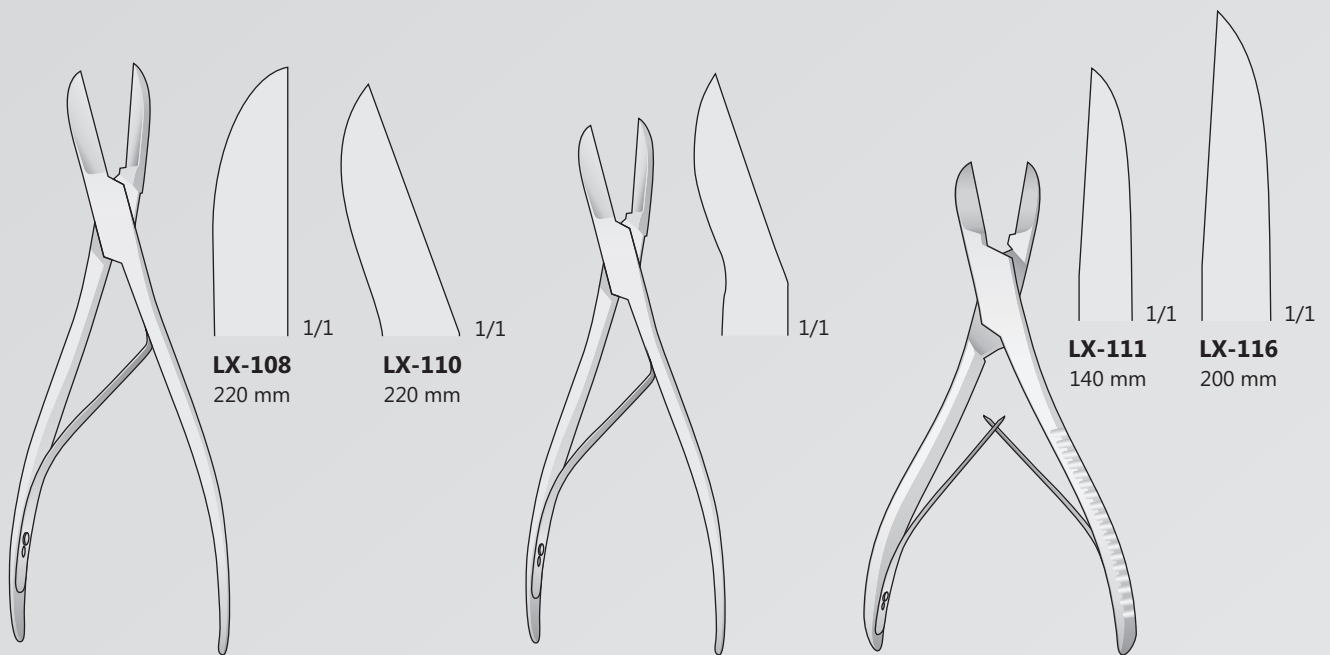

LISTON
LX-108/LX-110
220 mm

LISTON
LX-109
170 mm

LISTON
LX-111/LX-116
140 mm

Hohlmeißelzangen - Knochensplitterzangen
Bone rongeurs - Bone cutting Forceps
Pinze ossivore - Cesioie per ossa
Pinza-gubias - Pinzas cortantes para huesos
Pinces-gouges - Pincés coupantes

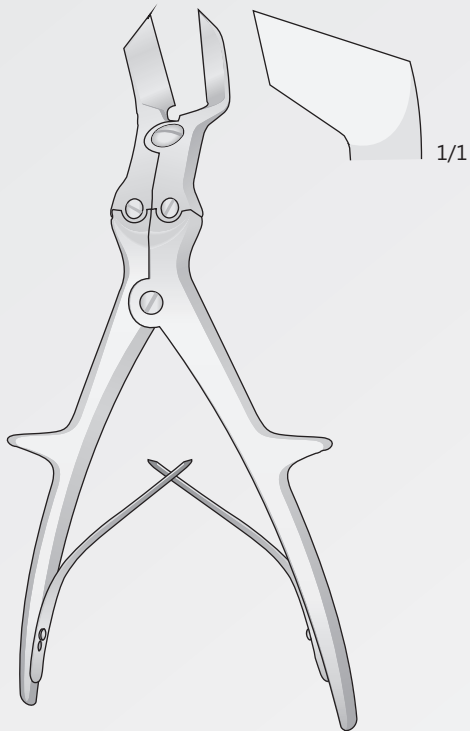

KEY-HORSLEY
FO-40
235 mm

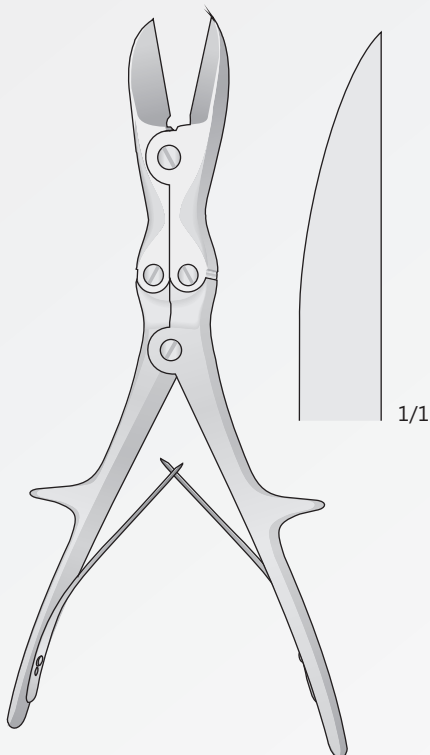

LISTON
FO-41
270 mm

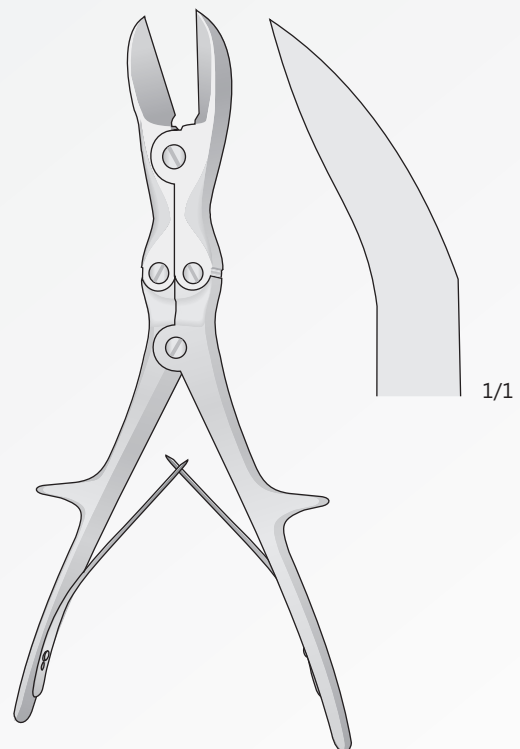

LISTON
FO-42
270 mm

Knochenhaltezangen
Bone holding forceps
Pinze per fissazione ossea
Pinzas para huesos
Daviers porte-os

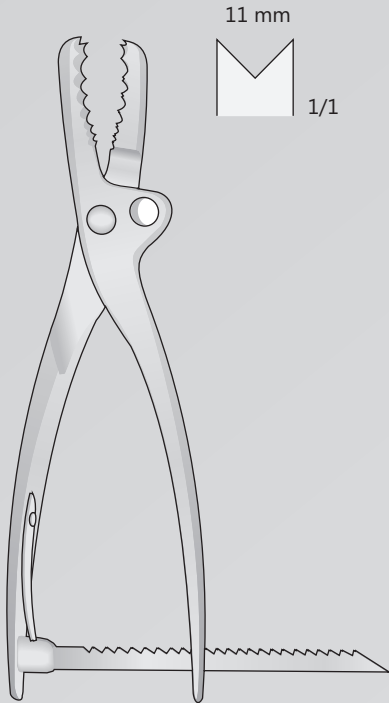

FARABEU-F-LAMBOTTE
FO-52
250 mm

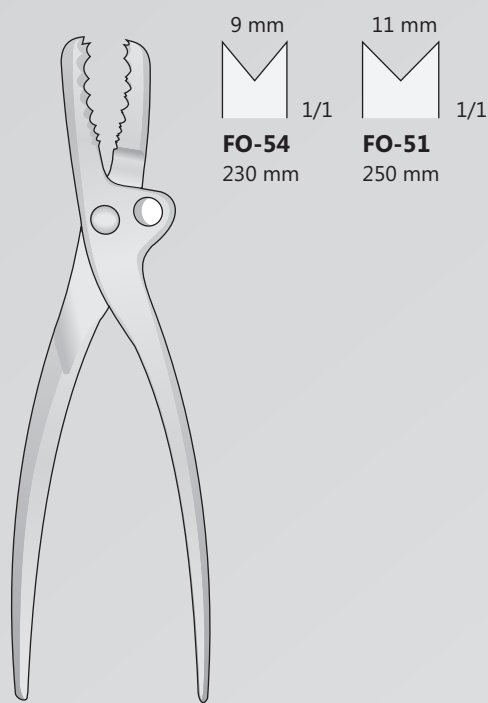

FARABEU
FO-51/FO-54

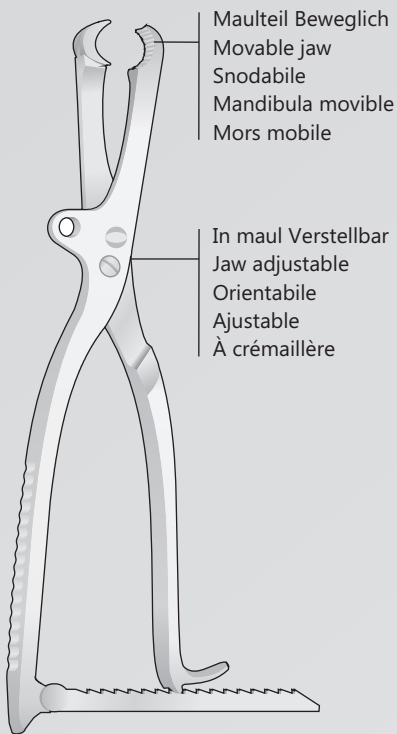

LAMBOTTE
FO-44
265 mm

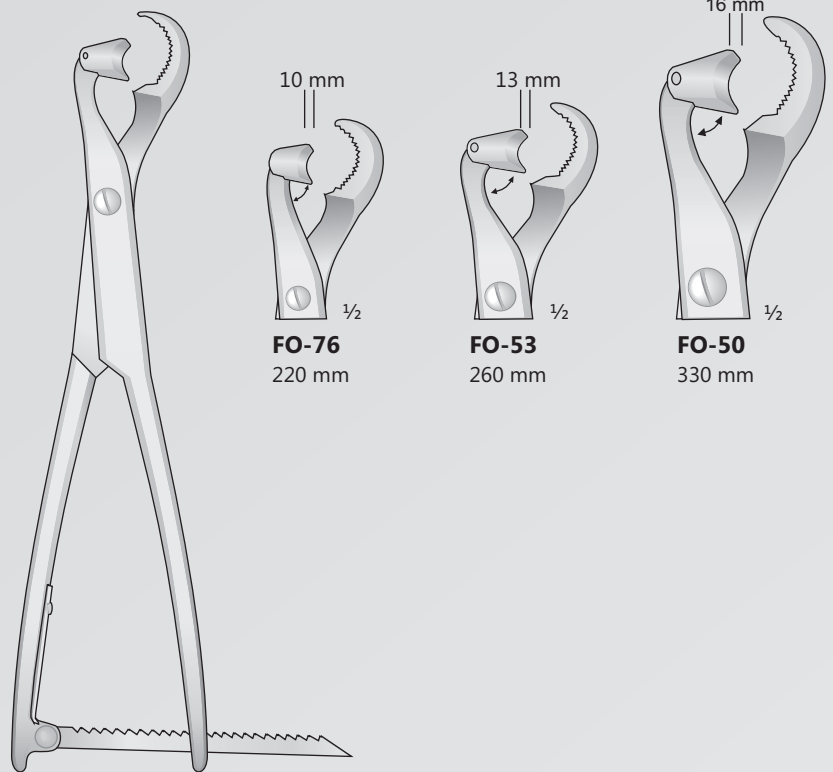

LAMBOTTE
FO-50/FO-76

Knochenhaltezangen
Bone holding forceps
Pinze per fissazione ossea
Pinzas para huesos
Daviers porte-os

Selbstzentrierend mit Gewindesperre
Self-centering bone holding forceps with thread lock
Autocentrante con blocco
Autocentrante con cremallera de tuerca
À centrage automatique avec arrêt de filetage

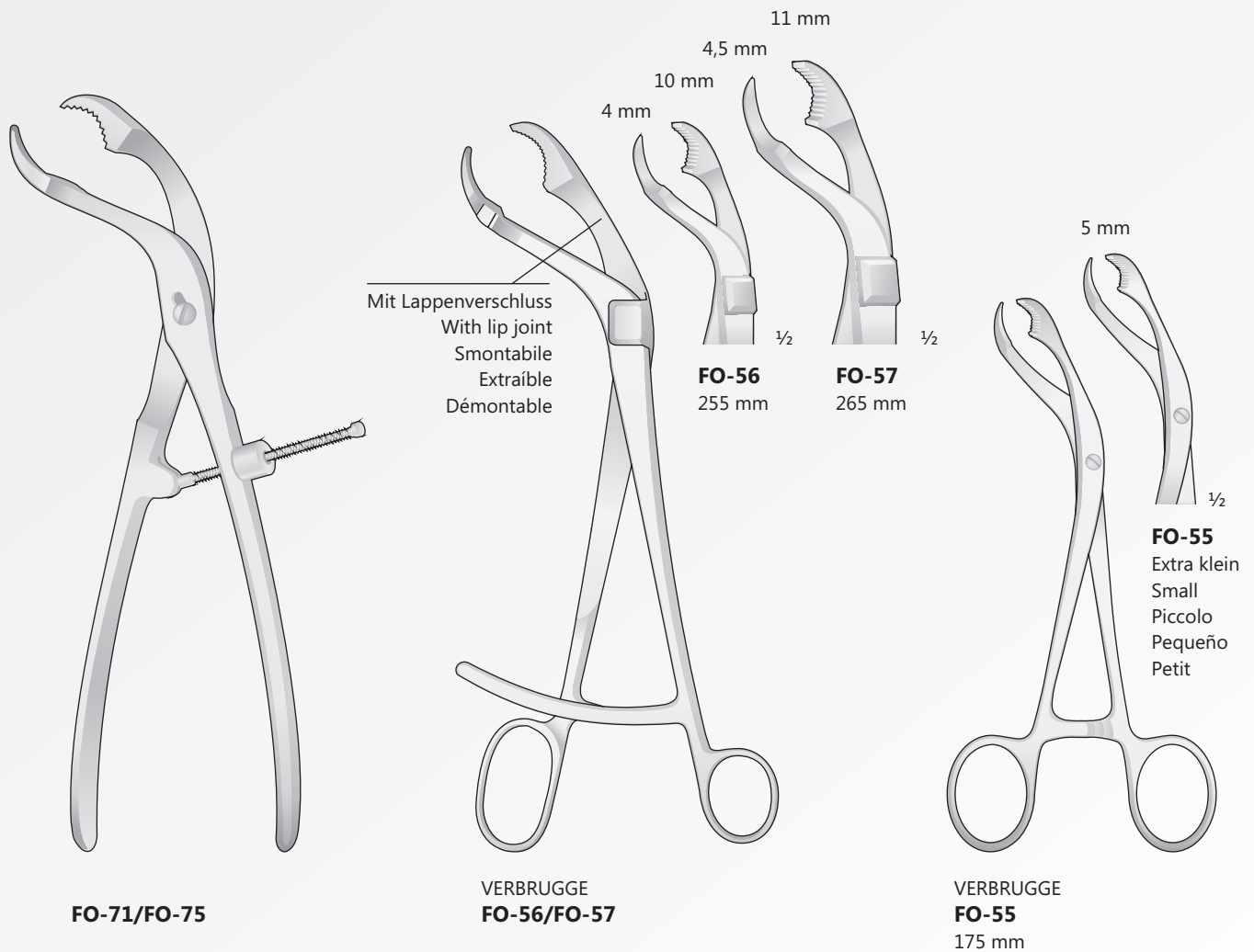
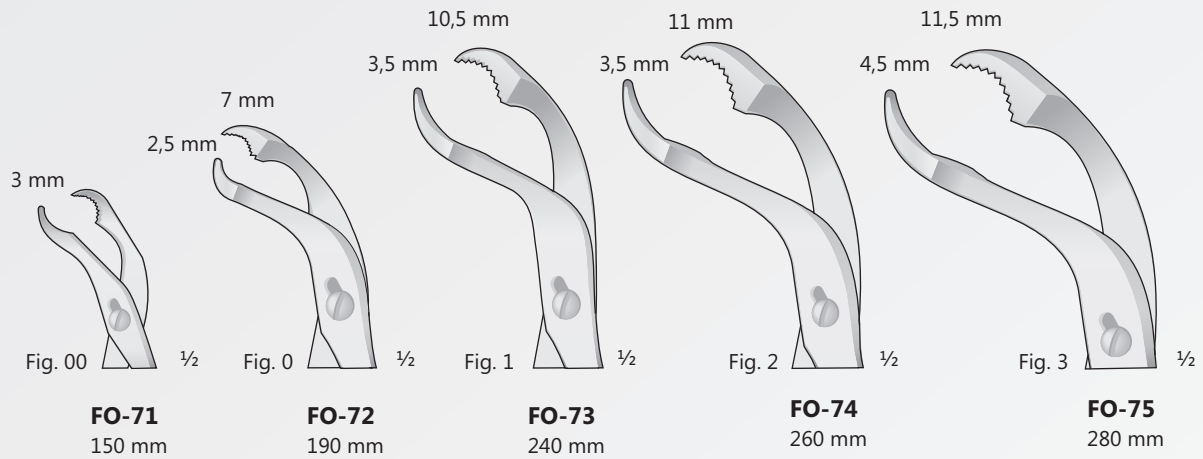

Hohlmeißelzangen - Knochensplitterzangen - Repositions Zangen
 Bone rongeurs - Bone cutting Forceps - Reposition Forceps
 Pinze ossivore - Cesoie per ossa - Pinze per riposizioni
 Pinza-gubias - Pinzas cortantes para huesos - Pinzas para reduccion
 Pincas-gouges - Pincas coupantes - Pincas à réduction

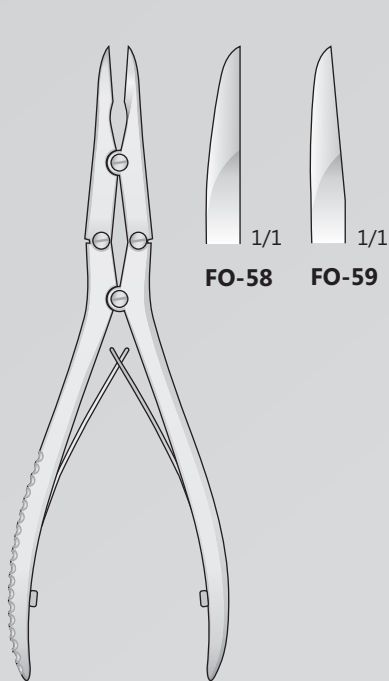

FO-58/FO-59
180 mm

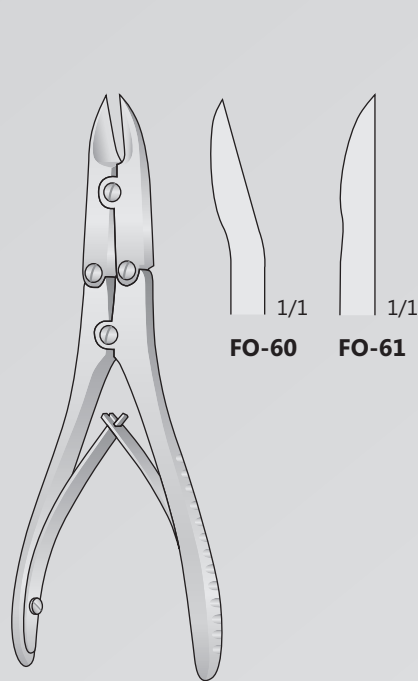

BÖHLER
FO-60/FO-61
150 mm

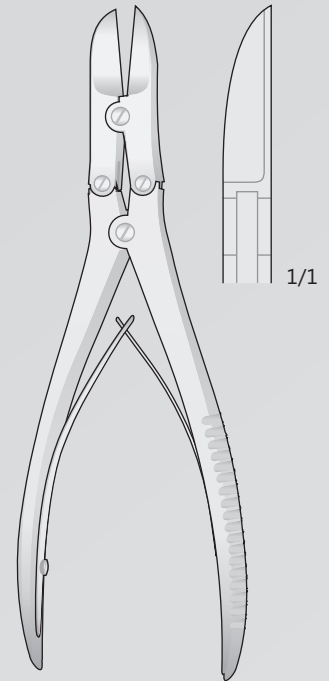

RUSKIN-LISTON
FO-108
190 mm

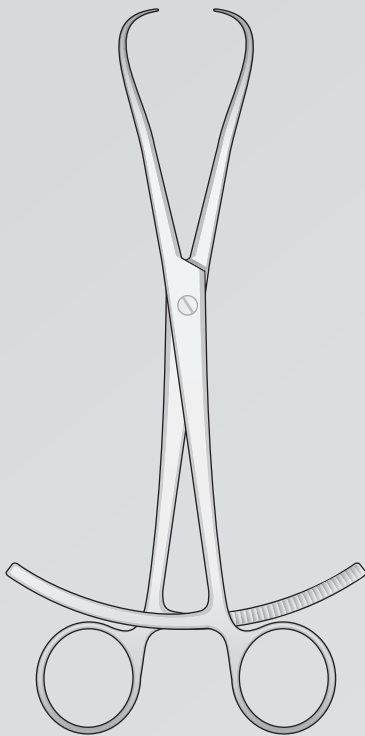

FO-68
200 mm

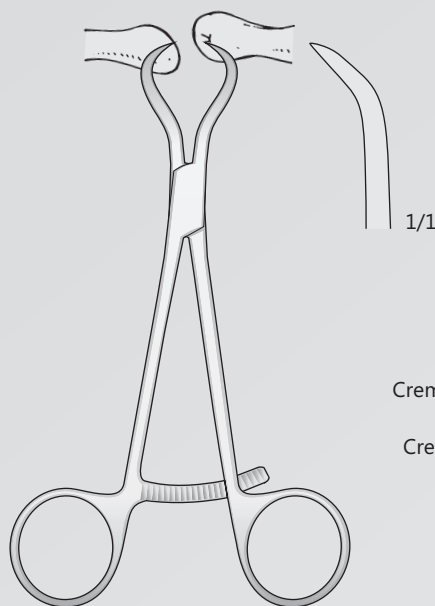

FO-66
135 mm

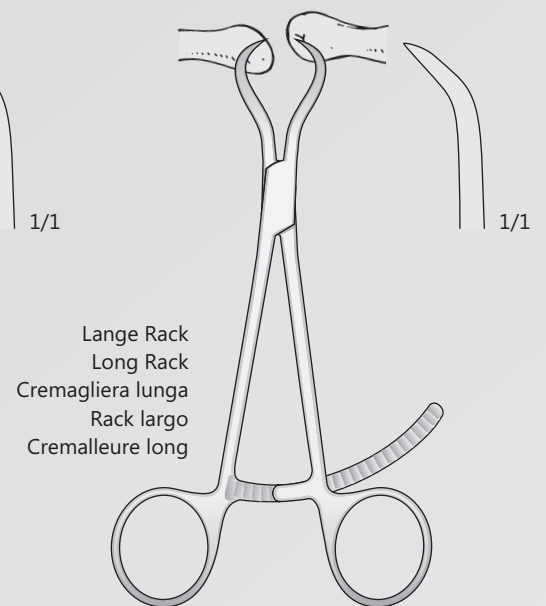

Lange Rack
 Long Rack
 Cremagliera lunga
 Rack largo
 Cremalleure long

FO-66L
135 mm

Repositions Zangen
Reposition Forceps
Pinze per riposizioni
Pinzas para reduccion
Pincas à réduction

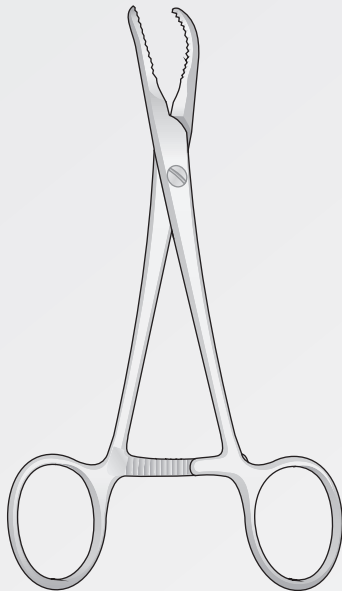

FO-47
140 mm

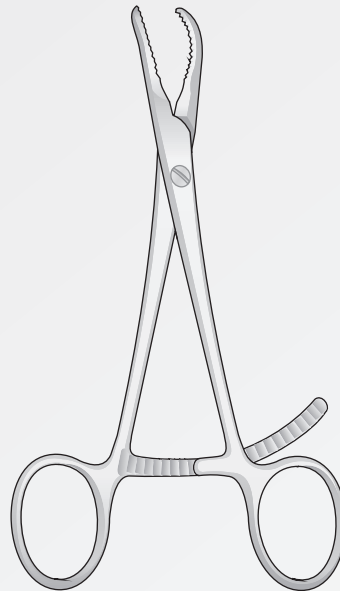

FO-47L
140 mm

Lange Rack
Long Rack
Cremagliera lunga
Rack largo
Cremalleure long

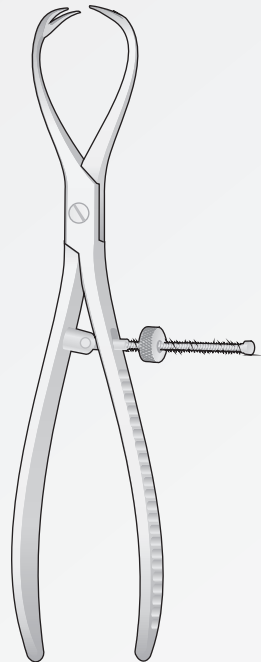
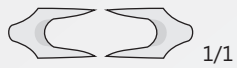

PATELLA
FO-46
185 mm

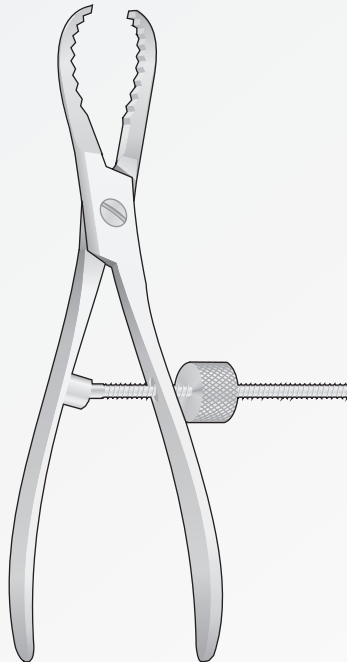

FO-48
170 mm

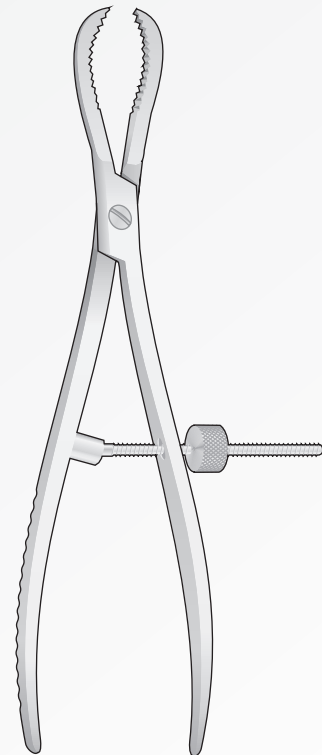

FO-49
235 mm

Hohlmeißelzangen
Bone rongeurs
Pinze ossivore
Pinza-gubias
Pinces-gouges

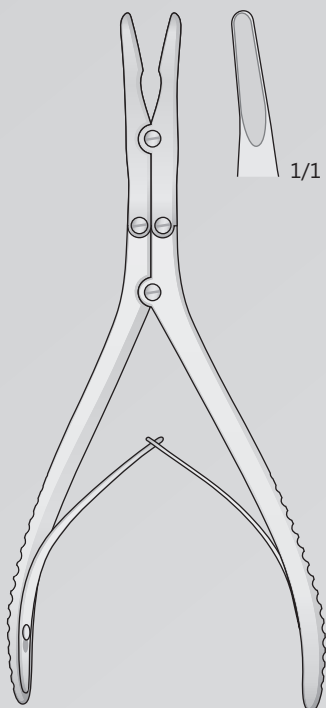

BEYER
FO-20
180 mm

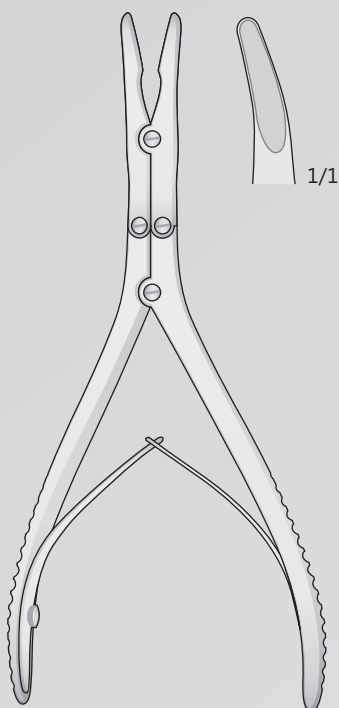

ZAUFAL-JANSEN
FO-34
180 mm

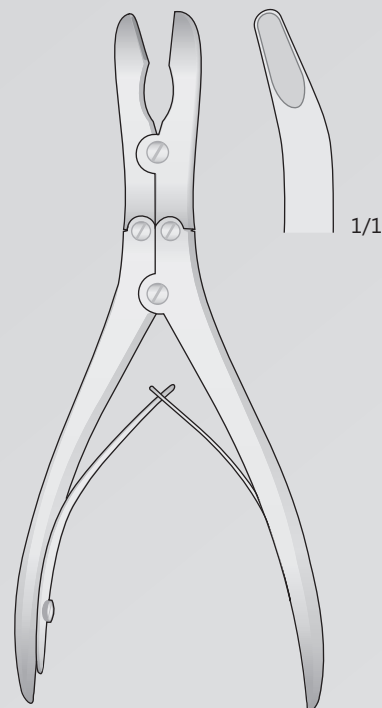

RUSKIN-STILLE
FO-35
180 mm

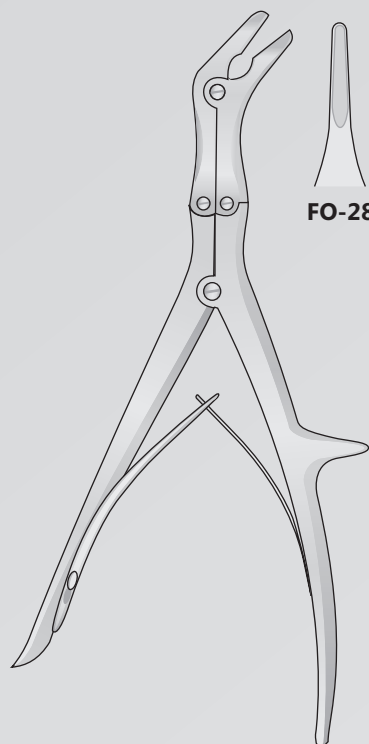

ECHLIN
FO-28/FO-30
230 mm

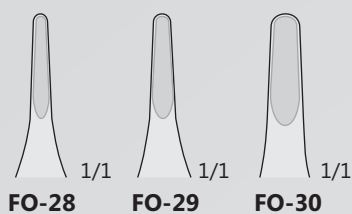

FO-28 1/1 **FO-29** 1/1 **FO-30** 1/1

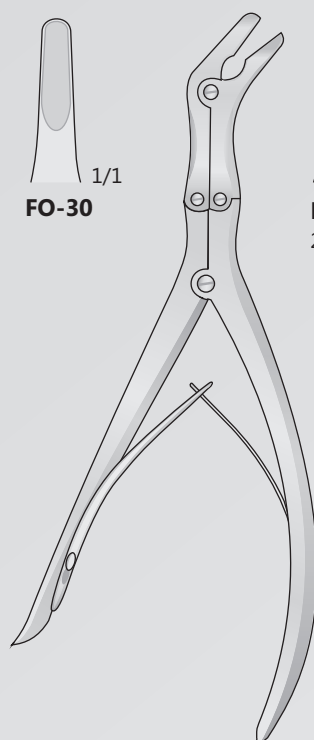

LEKSELL
FO-31/FO-32

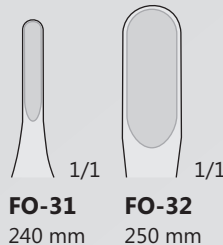

FO-31 1/1 **FO-32** 1/1
240 mm 250 mm

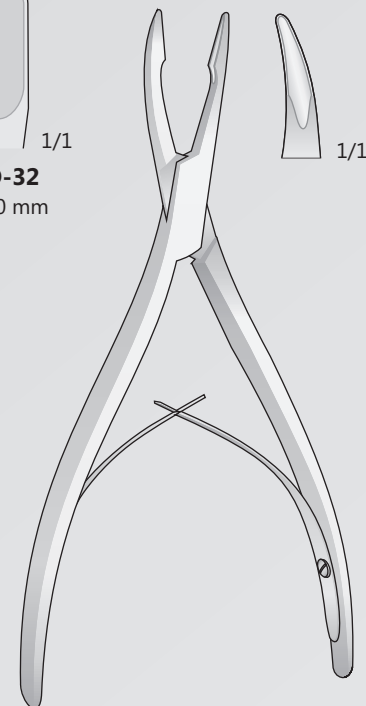

FRIEDMANN
FO-16
160 mm

Hohlmeißelzangen
Bone rongeurs
Pinze ossivore
Pinza-gubias
Pincés-gouges

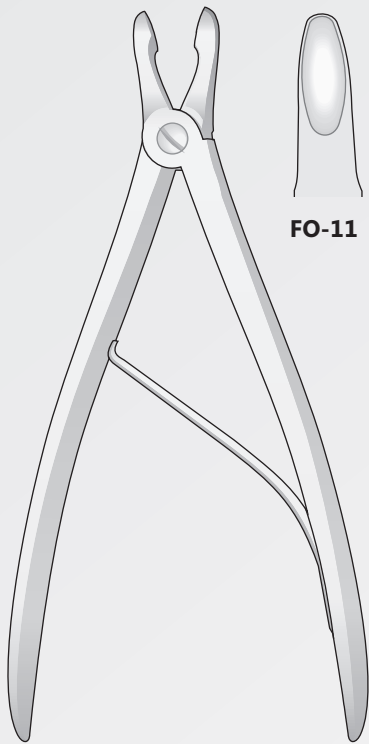

FO-11

1/1

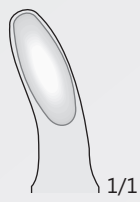

FO-12

1/1

CUSHING
FO-11/FO-12
190 mm

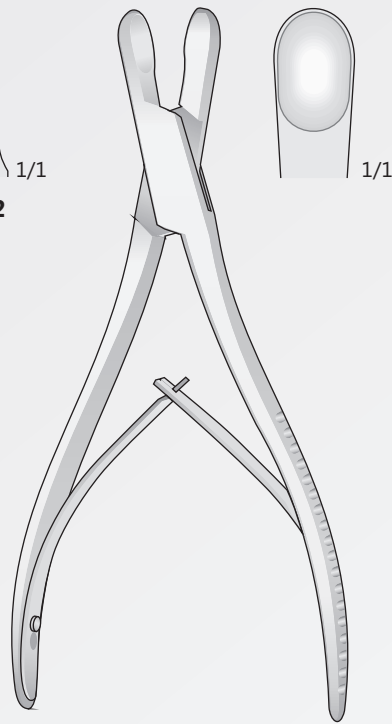

1/1

LUER-STILLE
FO-13
185 mm

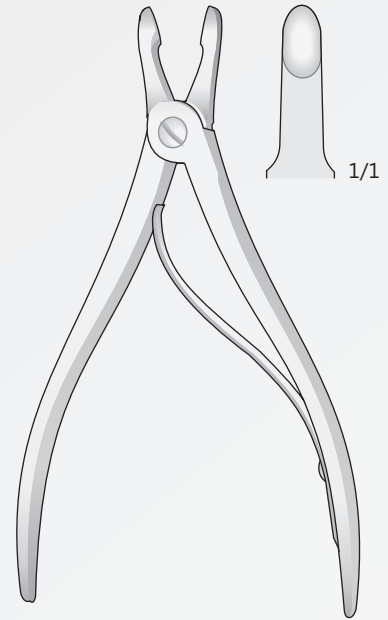

1/1

HARTMANN
FO-14
155 mm

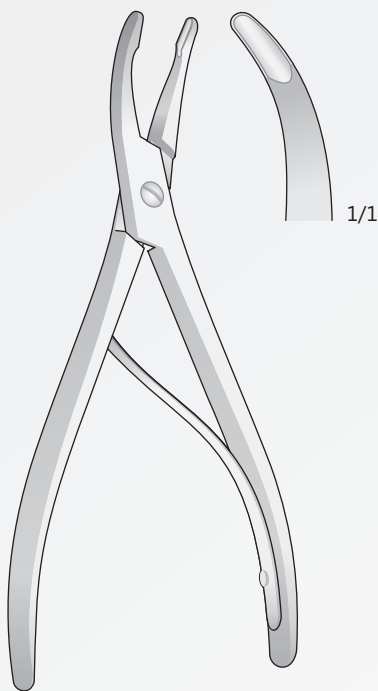

1/1

LUER
FO-18
155 mm

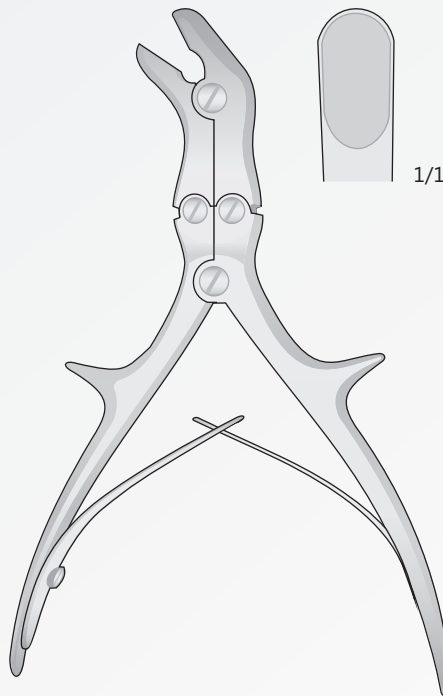

1/1

STILLE
FO-36
210 mm

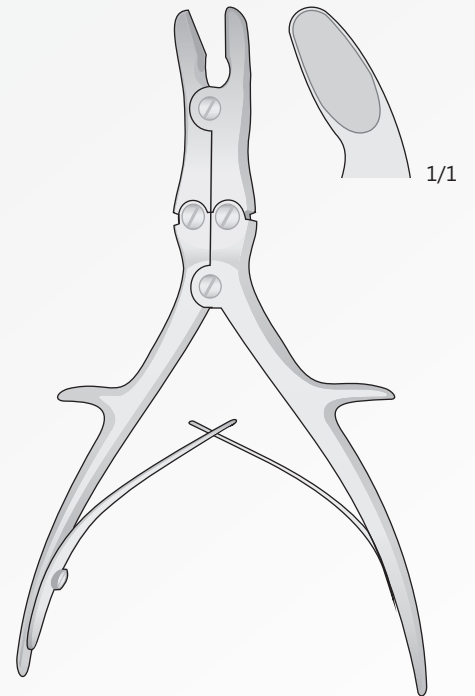

1/1

LUER-STILLE
FO-38
210 mm

Knochenchirurgie
Bone surgery
Chirurgia ossea
Cirurgia òsea
Chirurgie osseuse

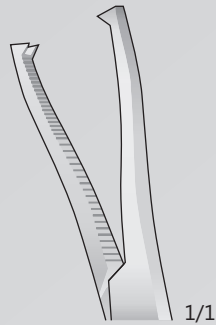
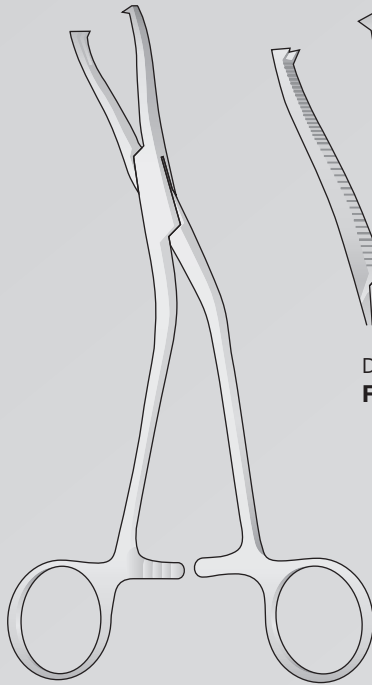

DINGMANN
FO-130

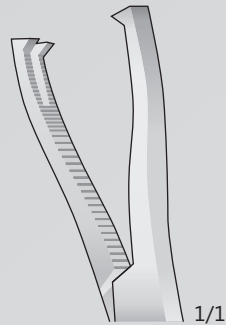

DINGMANN MODIF.
FO-131

Meniskus und Knorpelfasszangen
Meniscus and cartilage clamp
Pinze per menisco e cartilagine
Alicates para menisco y cartilago
Pinces à saisir ménisque et cartilages

DINGMANN
FO-130/FO-131
190 mm

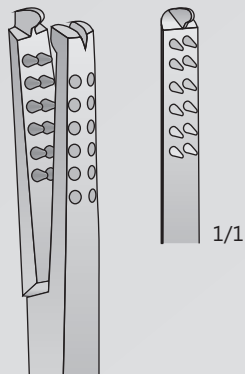
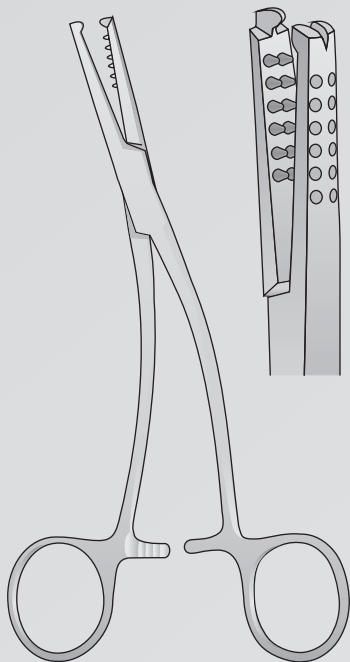

1/1

FO-134
185 mm

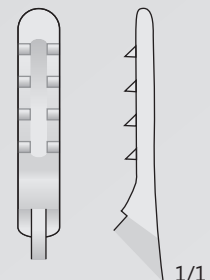
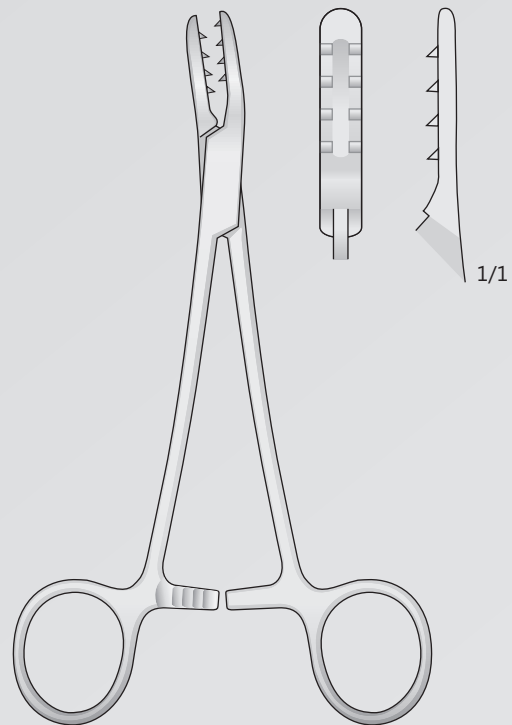

1/1

MARTIN
FO-133
200 mm

Repositionszangen
Reposition forceps
Pinze riposizionatrici di osso
Pinzas para la reducción de huesos
Pincas de l'os

Knochenchirurgie
Bone surgery
Chirurgia ossea
Cirurgia òsea
Chirurgie osseuse

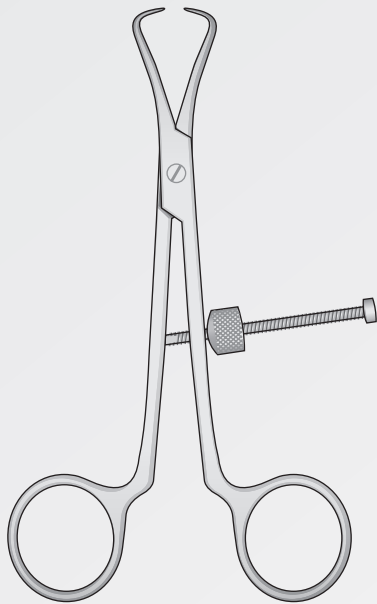

FO-79
140 mm

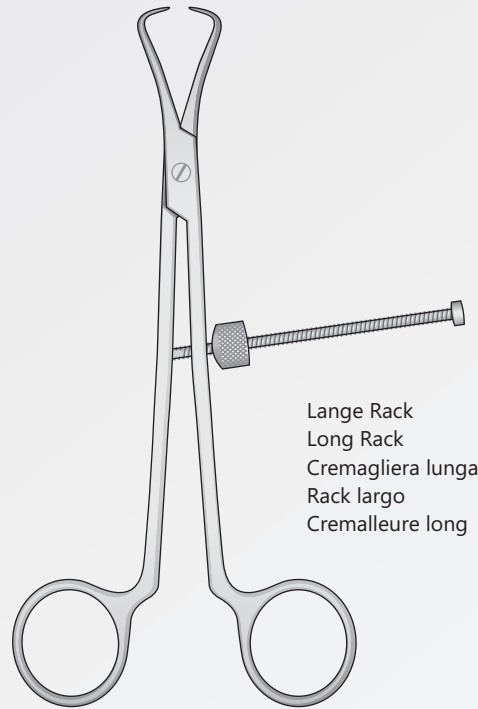

FO-79L
160 mm

Lange Rack
Long Rack
Cremagliera lunga
Rack largo
Cremalleure long

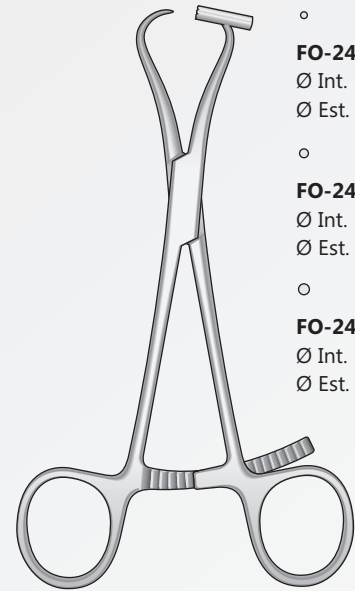

FO-240/FO-242
140 mm

- **FO-240**
Ø Int. 1,0 mm
Ø Est. 2,0 mm
- **FO-241**
Ø Int. 1,3 mm
Ø Est. 2,3 mm
- **FO-242**
Ø Int. 1,6 mm
Ø Est. 2,6 mm

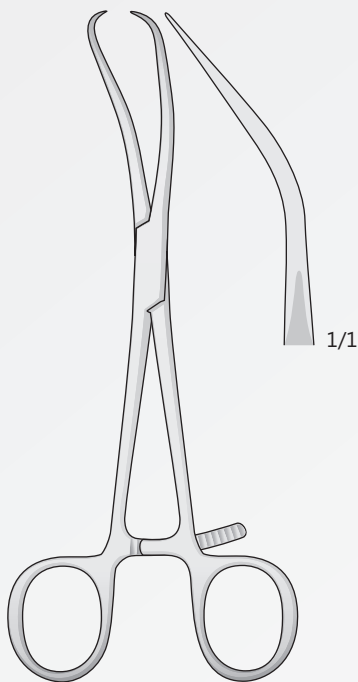

REILL
FO-64
170 mm

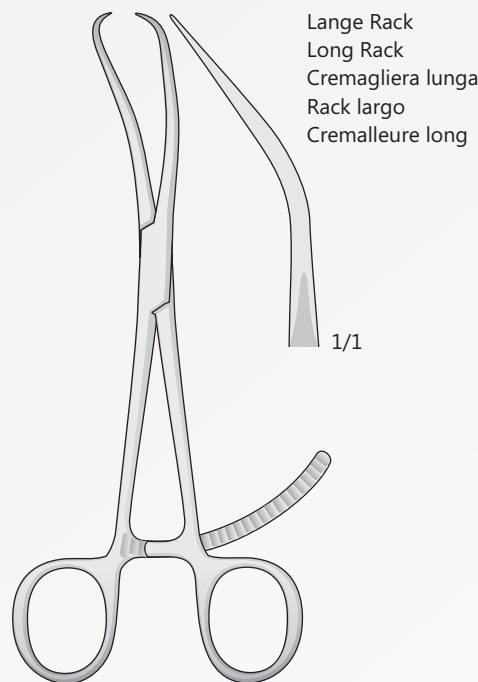

REILL
FO-64L
170 mm

Lange Rack
Long Rack
Cremagliera lunga
Rack largo
Cremalleure long

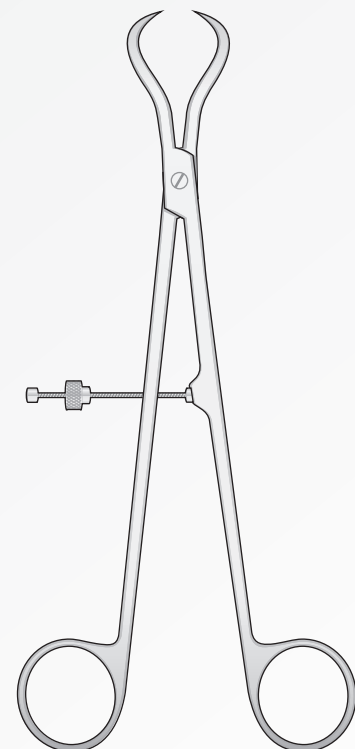

FO-81
210 mm

Knochenchirurgie
Bone surgery
Chirurgia ossea
Cirurgia òsea
Chirurgie osseuse

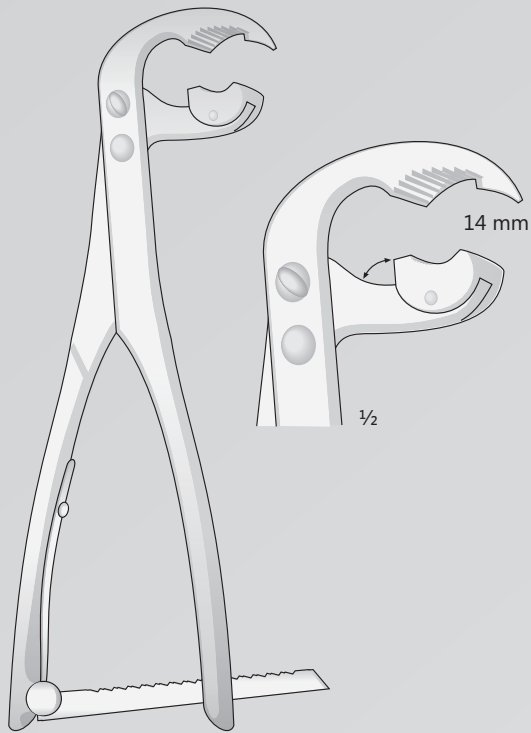

FO-78
215 mm

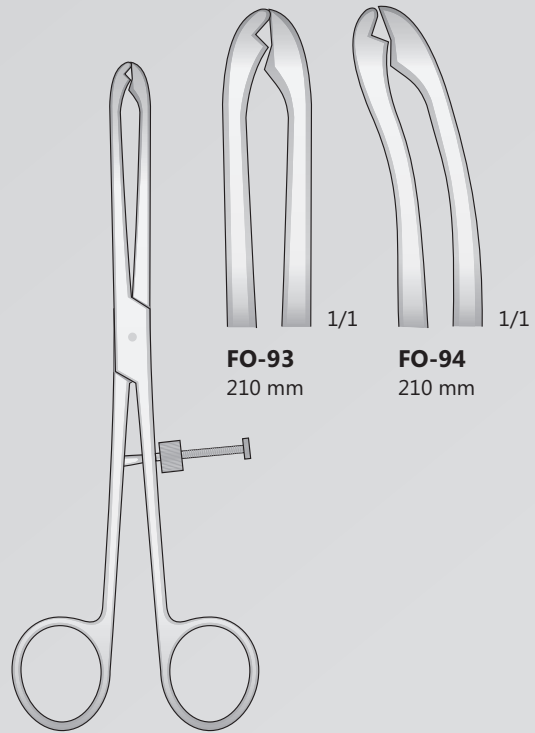

FIBULA
FO-93/FO-94
210 mm

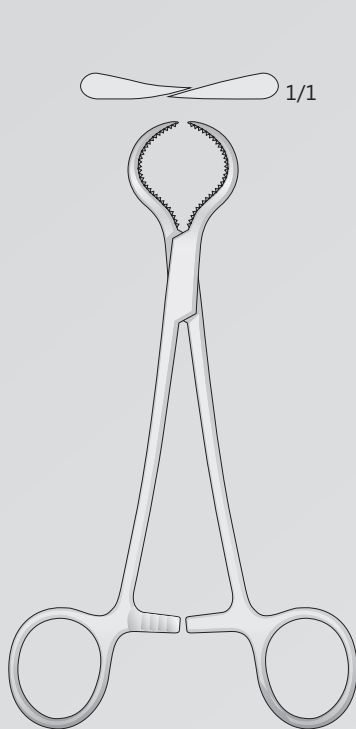

LEWIN
FO-69
180 mm

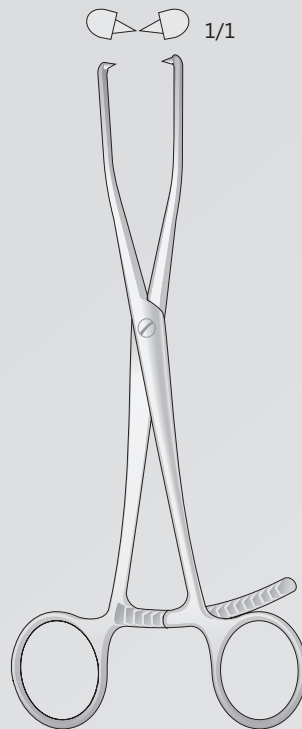

FO-67
210 mm

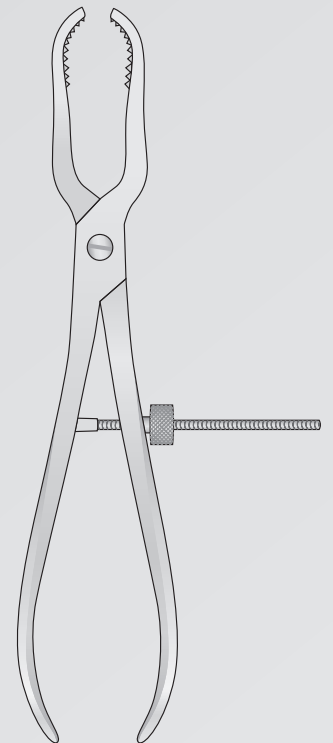

FO-65
230 mm

Knochenhaltezangen
Bone holding forceps
Pinze per fissazione ossea
Pinzas para huesos
Daviers porte-os

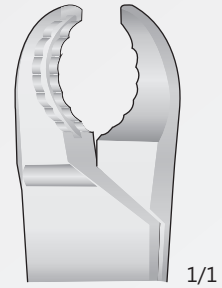

1/1

FO-62
230 mm

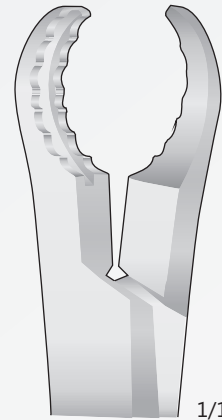

1/1

FO-82
250 mm

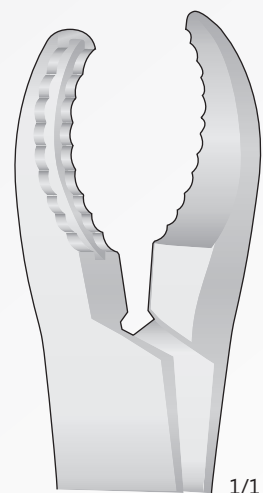

1/1

FO-105
280 mm

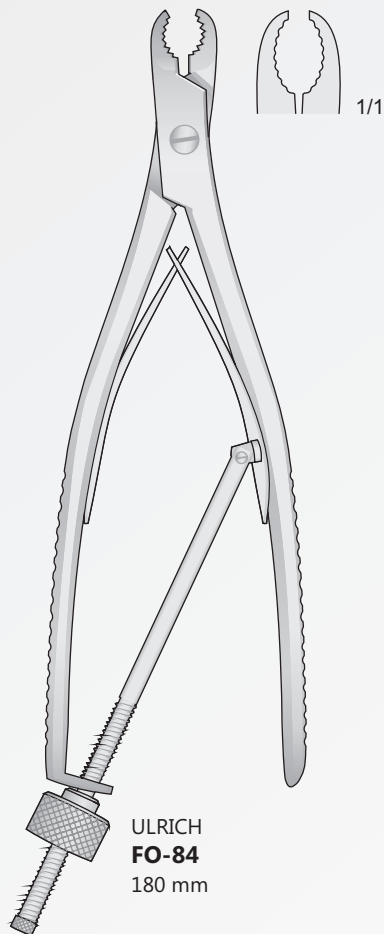

ULRICH
FO-84
180 mm

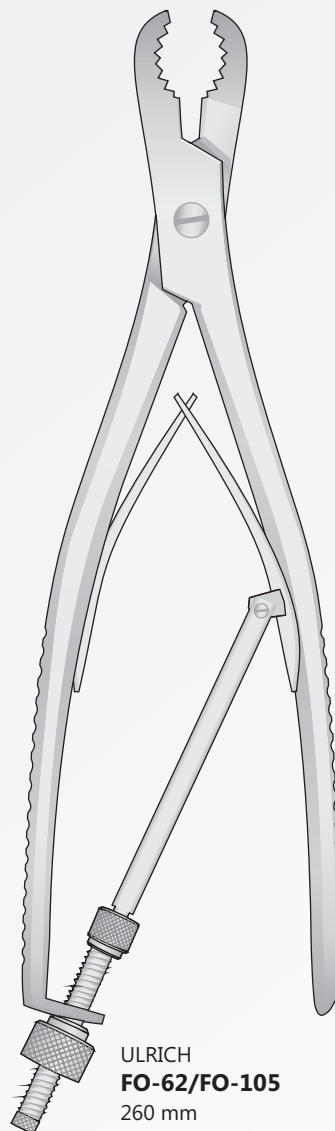

ULRICH
FO-62/FO-105
260 mm

Knochenhaltezangen
Bone holding forceps
Pinze per fissazione ossea
Pinzas para huesos
Daviers porte-os

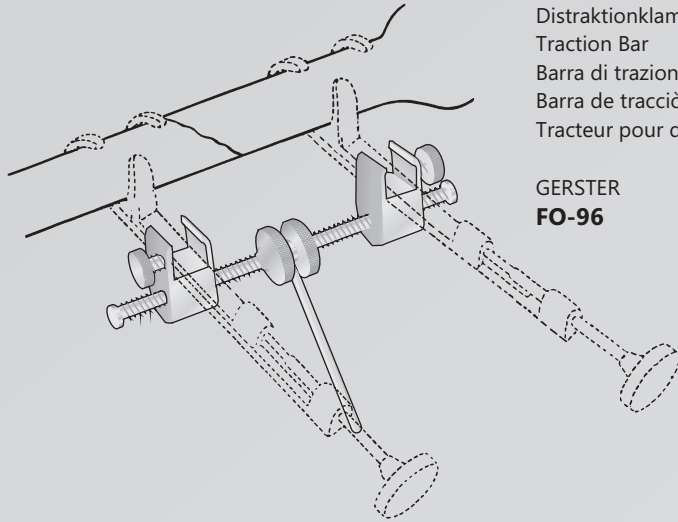

Distractionklammer
Traction Bar
Barra di trazione
Barra de tracciòn
Tracteur pour daviers

GERSTER
FO-96

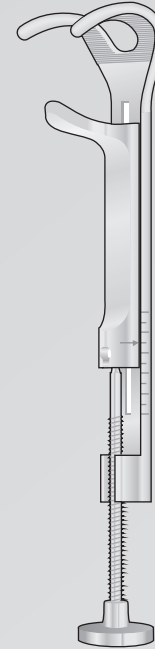

GERSTER-LOWMAN
FO-90 120 mm
FO-91 185 mm
FO-92 200 mm

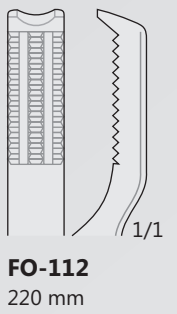
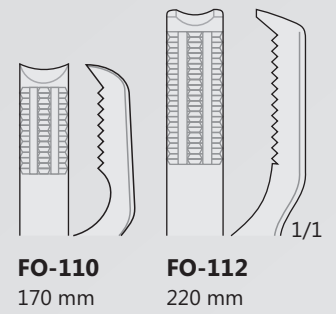
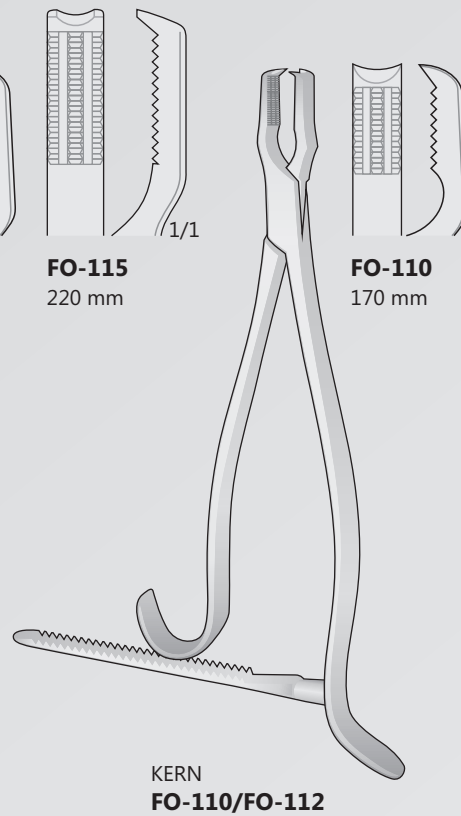
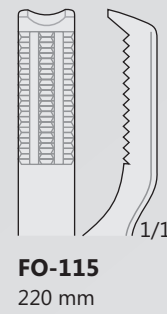
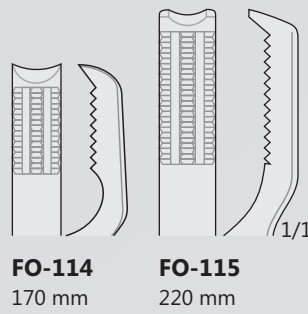
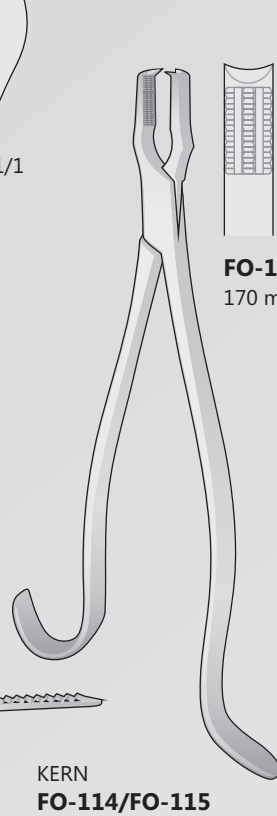
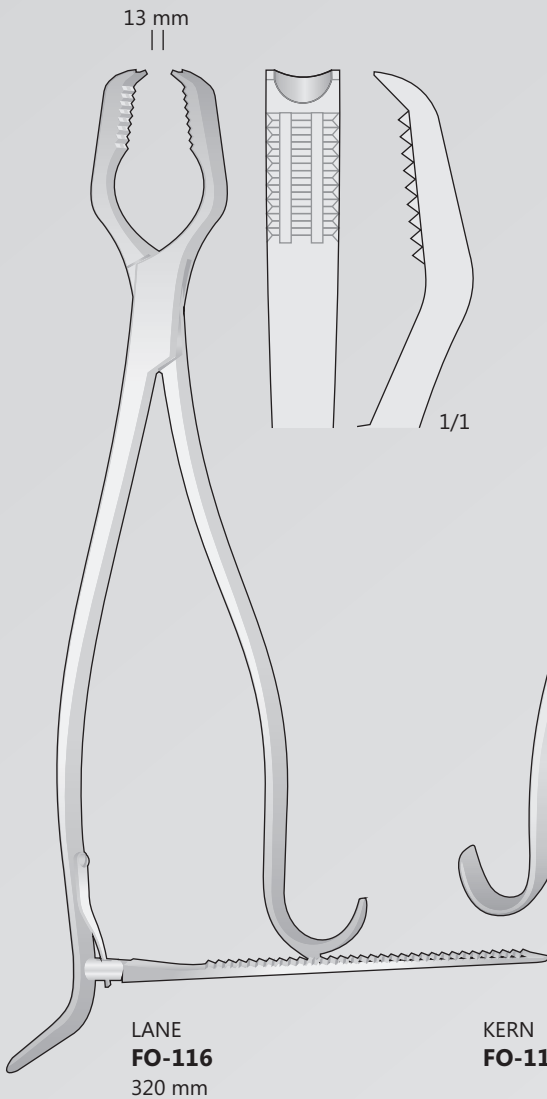

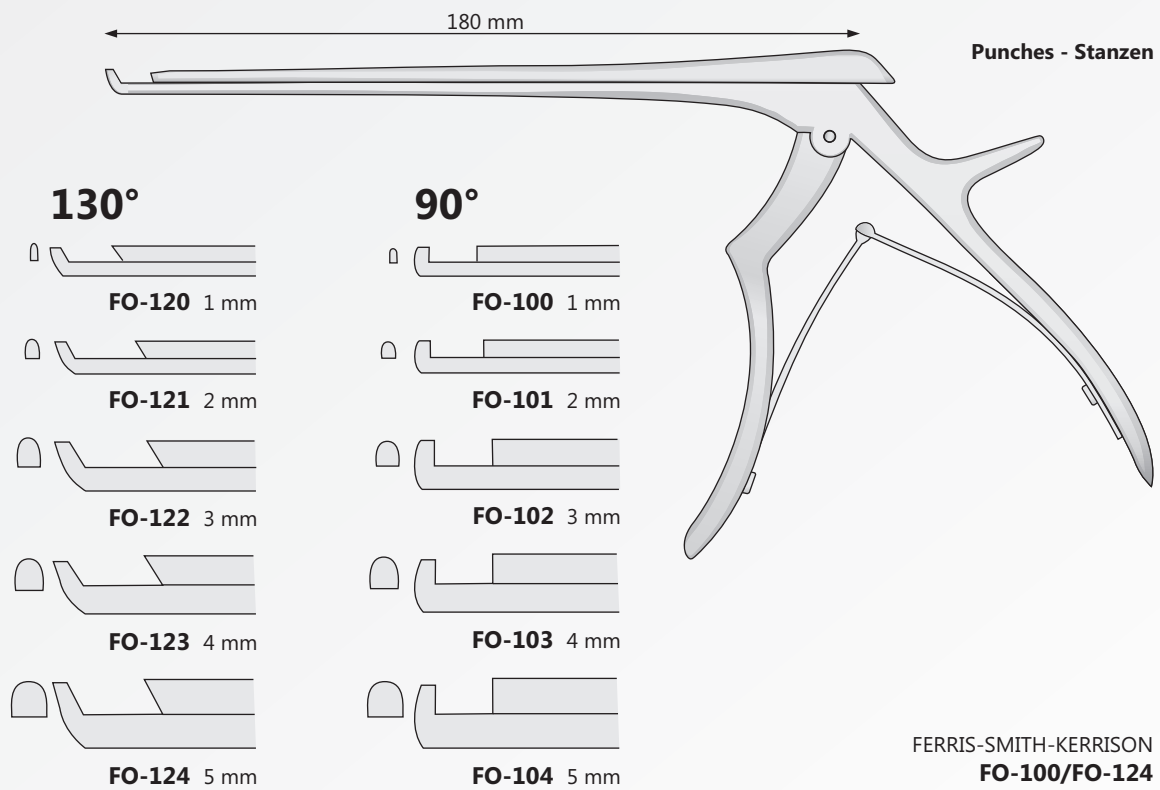
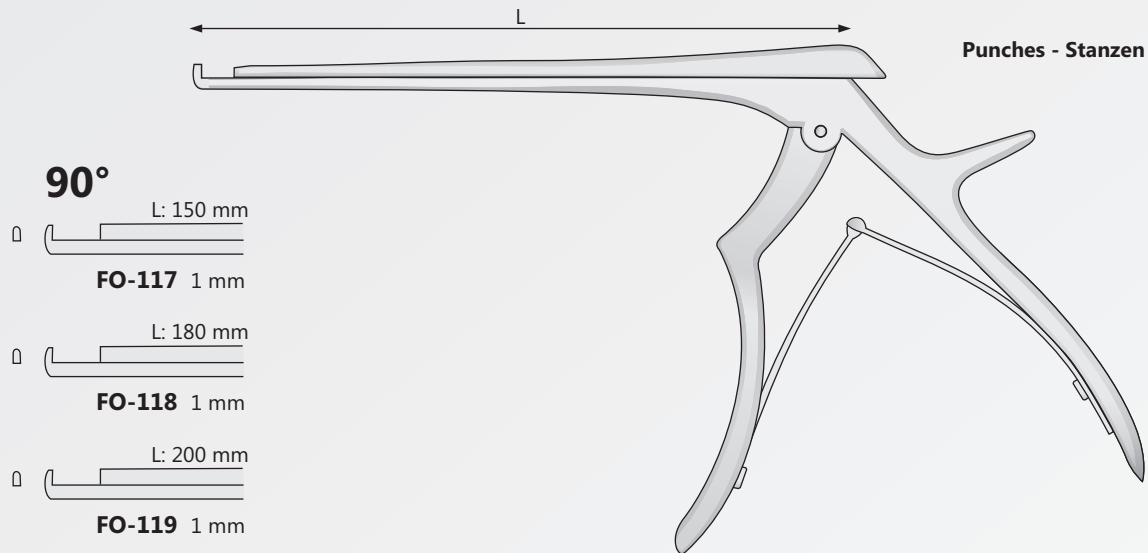

Laminektomie
Laminectomy
Laminectomia
Laminectomia
Laminectomie

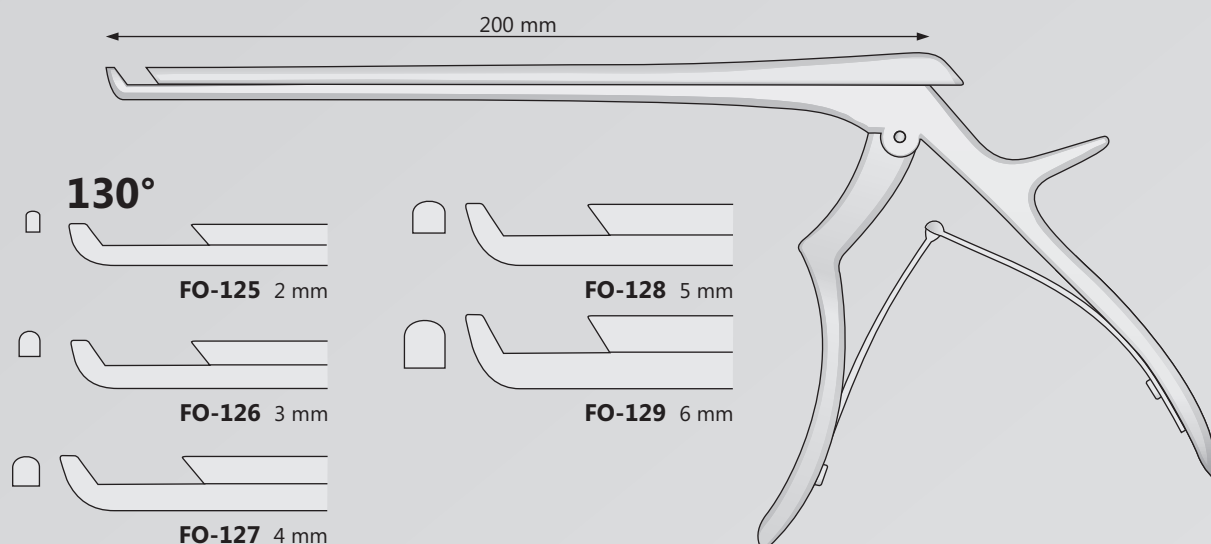

FERRIS-SMITH-KERRISON
FO-125/FO-129

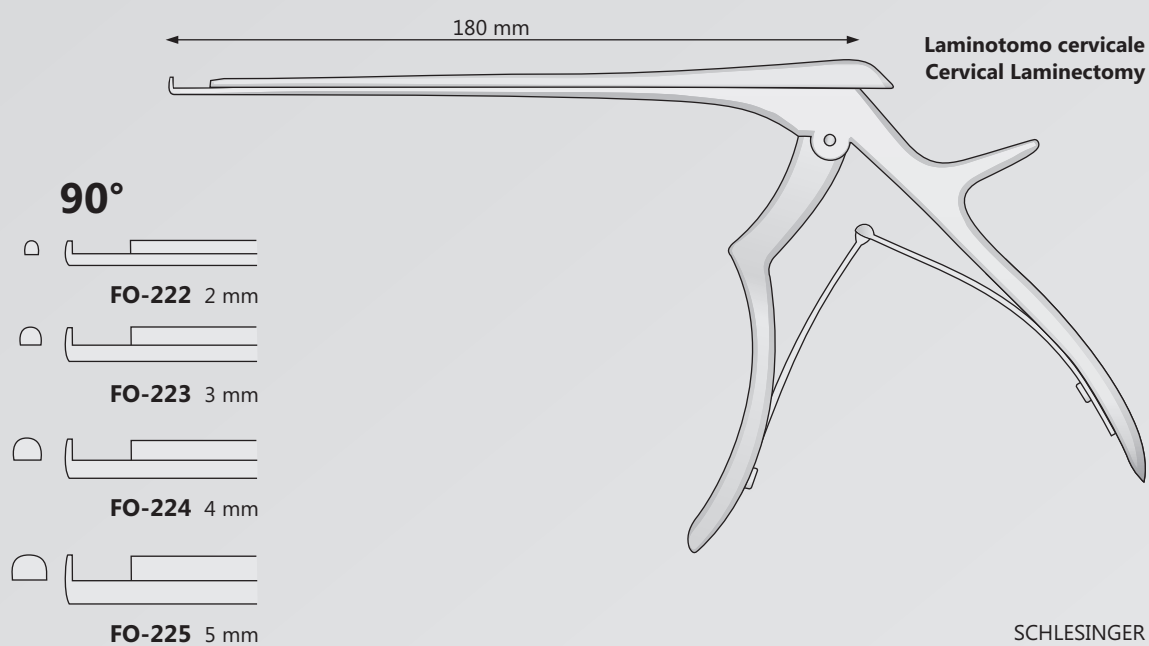

SCHLESINGER
FO-222/FO-225

Laminektomie
Laminectomy
Laminectomia
Laminectomia
Laminectomie

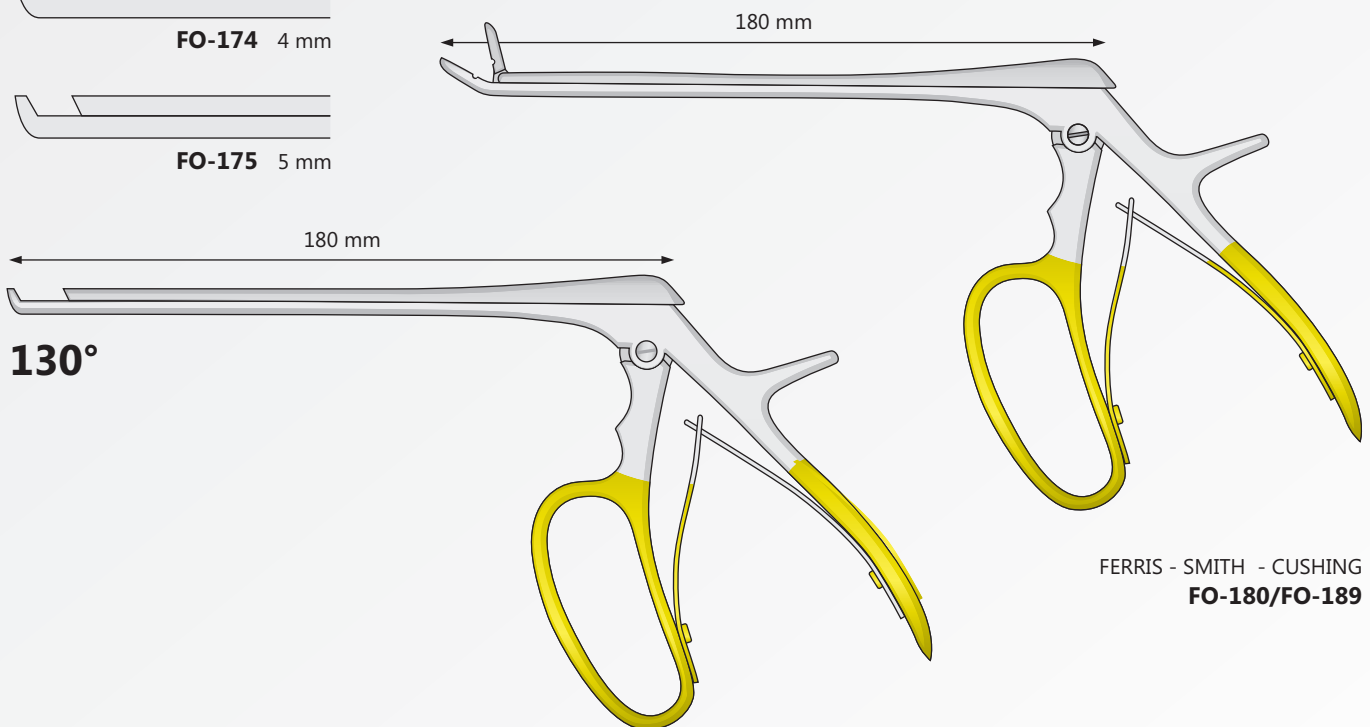
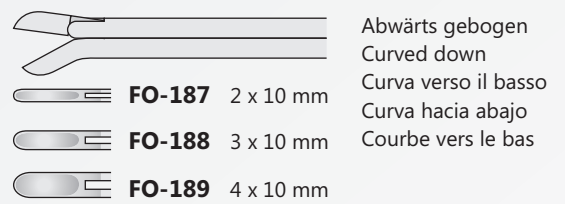
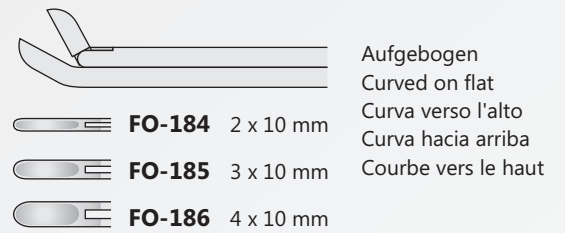
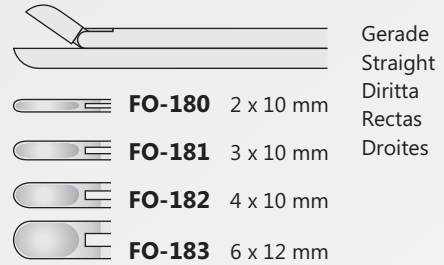
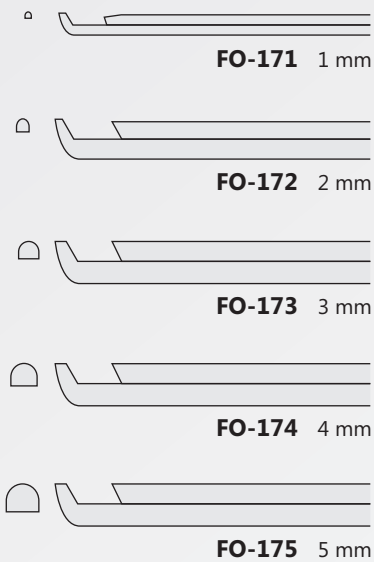

Arthroskopie Mikro-zangen
Arthroscopy Micro forceps
Micro Pinze per Artroscofia
Micro pinzas para Artroscofia
Micro Pincas pour Arthroscopie

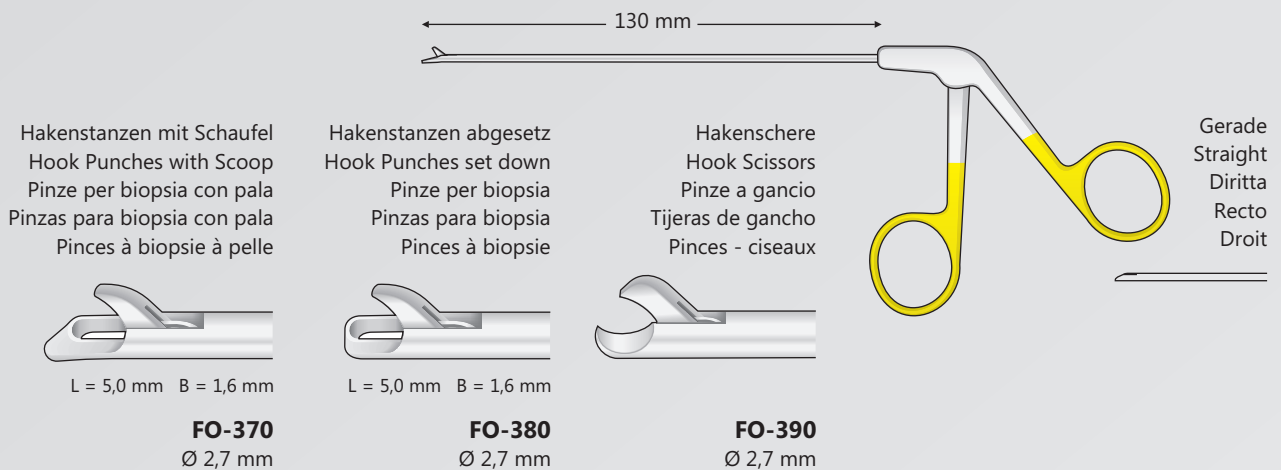
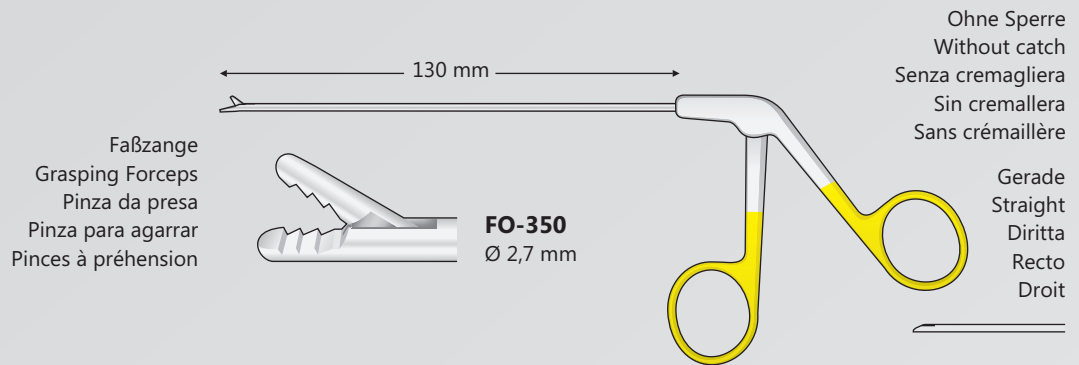
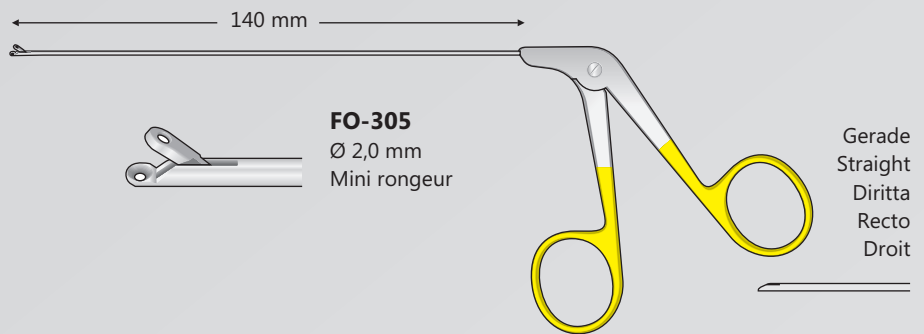
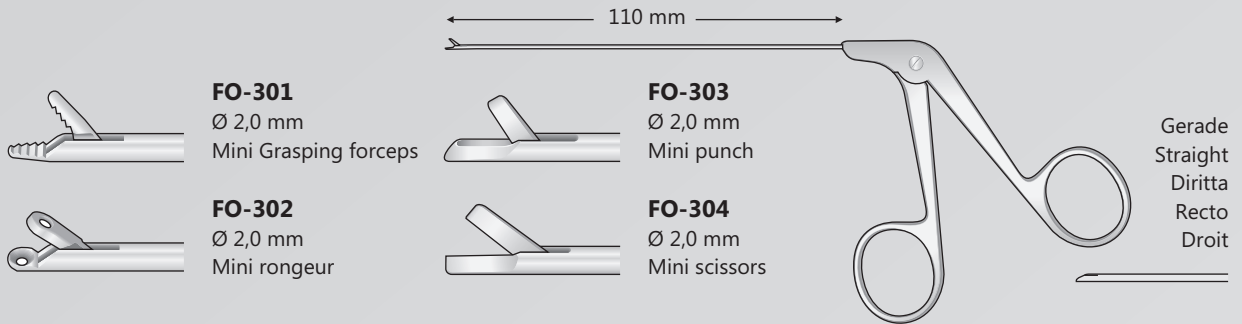

Laminectomy Rongeure
Laminectomy rongeurs
Pinze per biopsia
Pinzas cortantes para laminectomia
Pincas a laminectomia

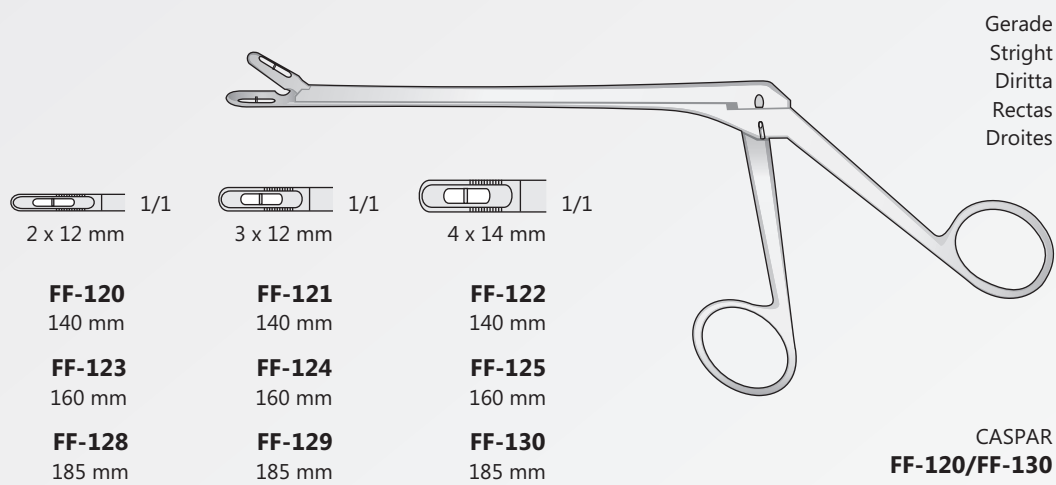

150°

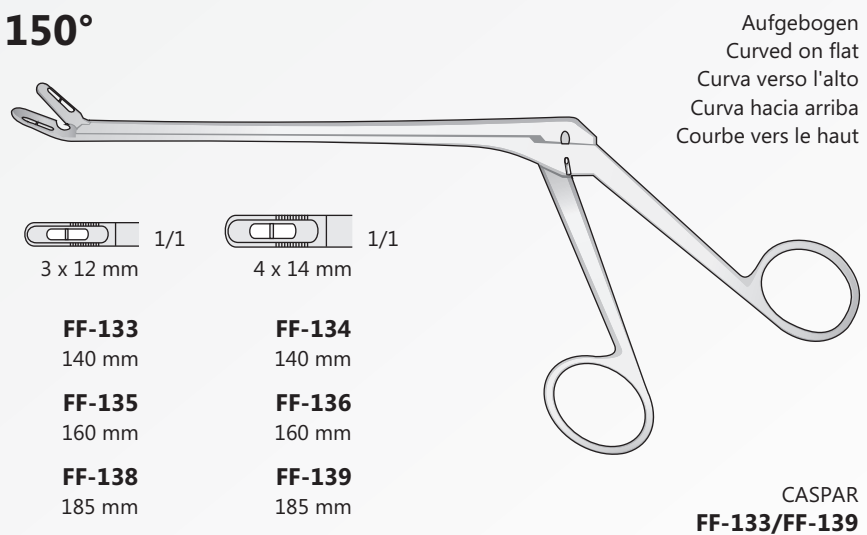

Laminectomy Rongeurs
Laminectomy rongeurs
Pinze per biopsia
Pinzas cortantes para laminectomia
Pincas a laminectomia

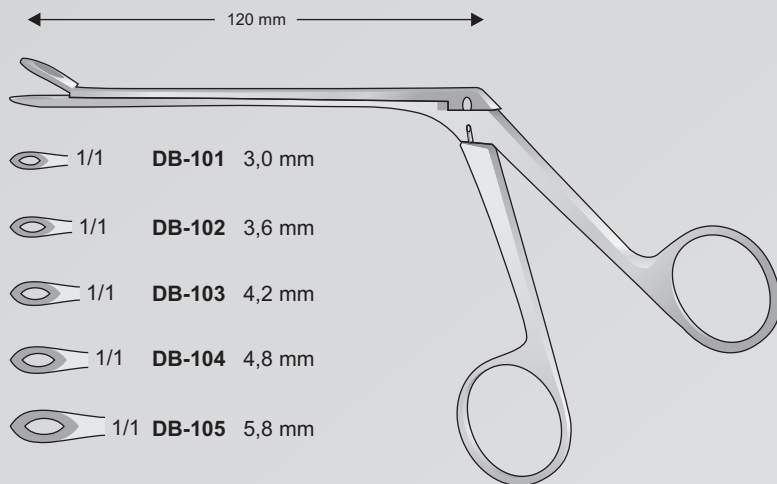

WEIL-BLAKESLEY
DB-101/DB-105
190 mm

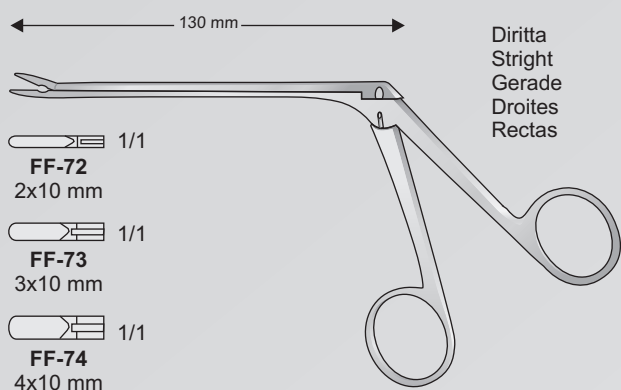

LOVE-GRUENWALD
FF-72/FF-74

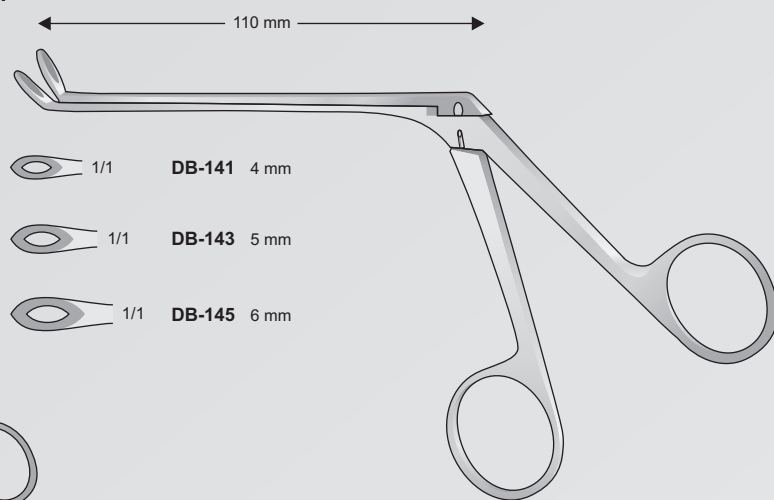

WEIL-BLAKESLEY
DB-141/DB-145
190 mm

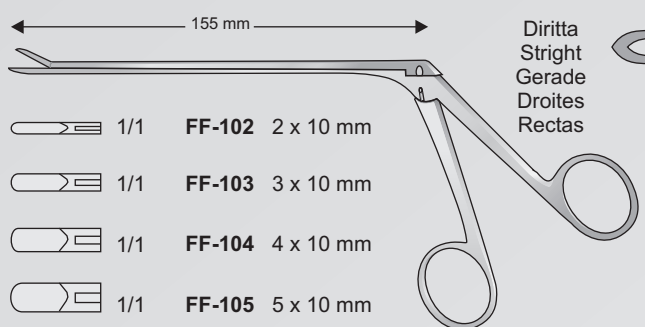

CASPAR
FF-102/FF-105

Handle only
Griff allein
125 mm



AS-10
125 mm

Spoon Ø 3 mm
30° curved
Löffel Ø 3 mm
30° gebogen



AS-16
225 mm

Probe graduated
2,5 mm
Sonde graduirt
2,5 mm



AS-19
220 mm

Probe graduated
3,5 mm
Sonde graduirt
3,5 mm



AS-20
220 mm

Meniscotome
Meniskotome



AS-31
220 mm

Hook-Probe
Hakensonde
4 mm



AS-35
220 mm

Spoon Ø 3 mm
30° curved
Löffel Ø 3 mm
30° gebogen



AS-36
220 mm

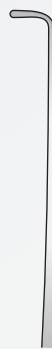

BT-296

BT-297

CUSHING
BT-296/BT-297
190 mm

Knochensplitterzangen
Bone cutting Forceps
Cesoie per ossa
Pinzas cortantes para huesos
Pincas coupantes

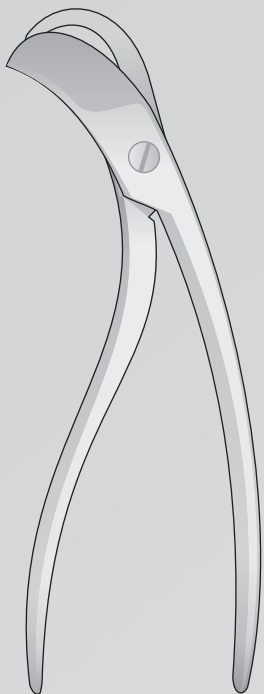

COLLIN
LX-112
195 mm

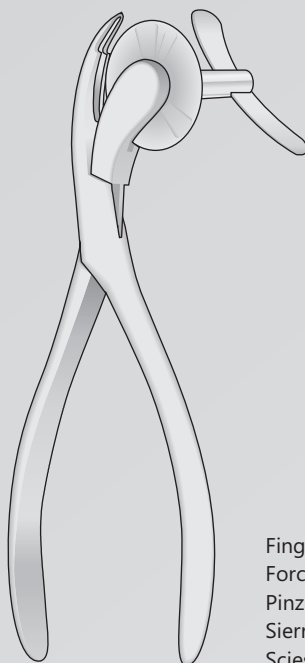

FO-80
170 mm

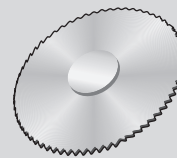

FO-80R
Ersatzsägeblatt
Spare saw blade
Lama di ricambio per sega
Hoja de reposito
Lame de scie de rechange

Fingerringssägen
Forceps for opening rings
Pinza taglia anelli
Sierra para anillos
Scies pour bagues



FG-40
230 mm

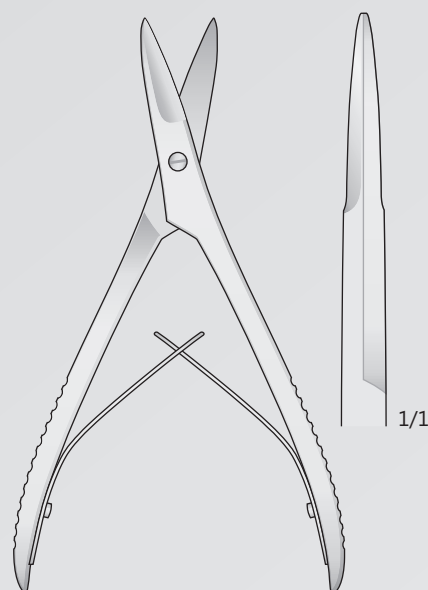
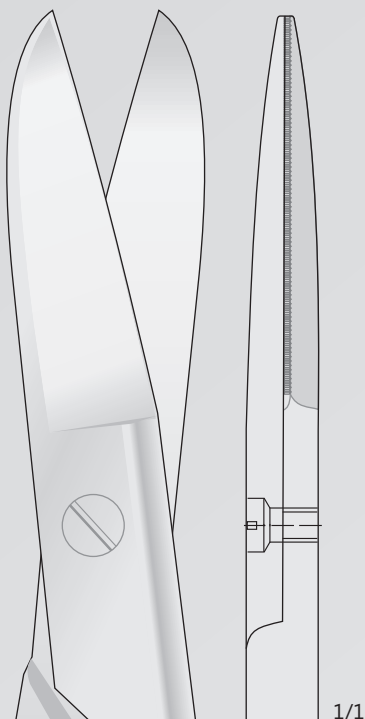

FO-63
160 mm

Gipsspreizer Gipsabreisszangen
Plaster spreader Plaster cast breakers
Strumenti per gesso
Pinza para arrancar vendajes
Pincas pour appareils plâtrés

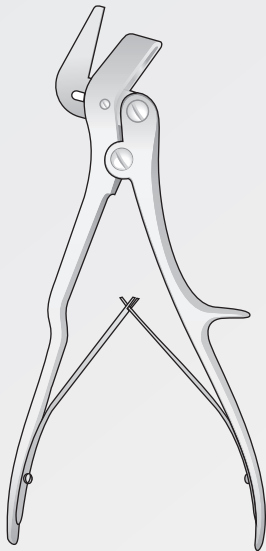

STILLE
LX-120
230 mm

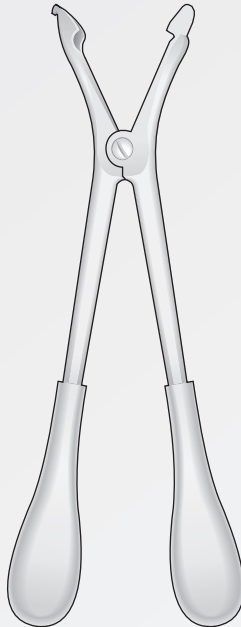

HAGLUND
LX-121
280 mm

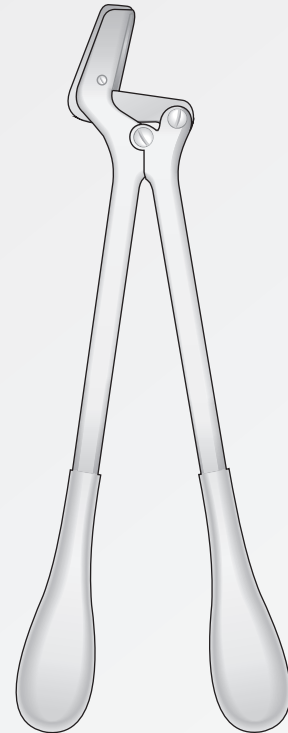

STILLE
LX-122
370 mm

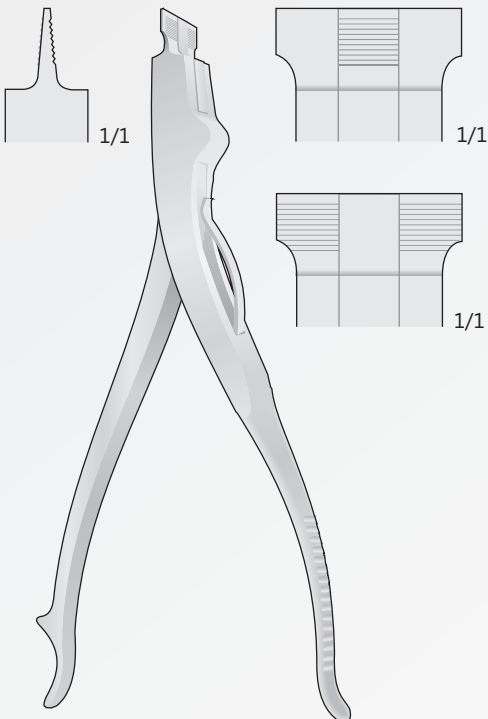

LX-115
220 mm

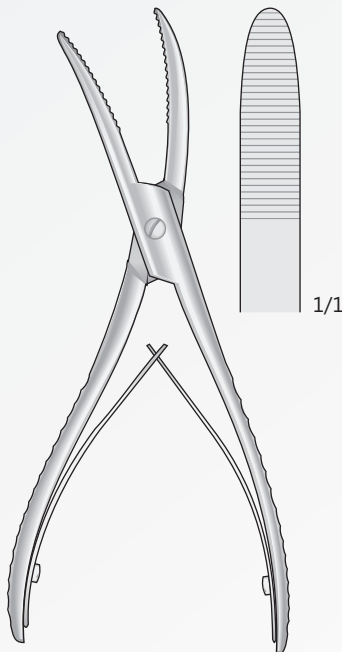

WOLFF
LX-113
180 mm

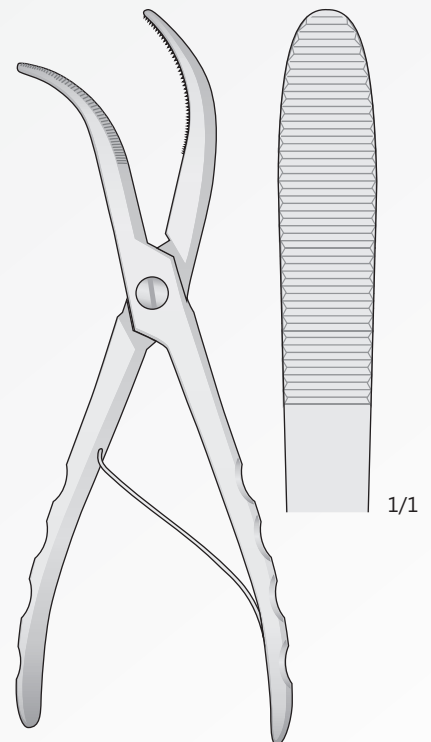

WOLFF
LX-114
250 mm



BONTEMPI
CHIRURGISCHE INSTRUMENTE

Trokare
Trocars
Trequarti
Tròcares
Trocarts

Trokare
Trocars
Trequarti
Tròcares
Trocarts

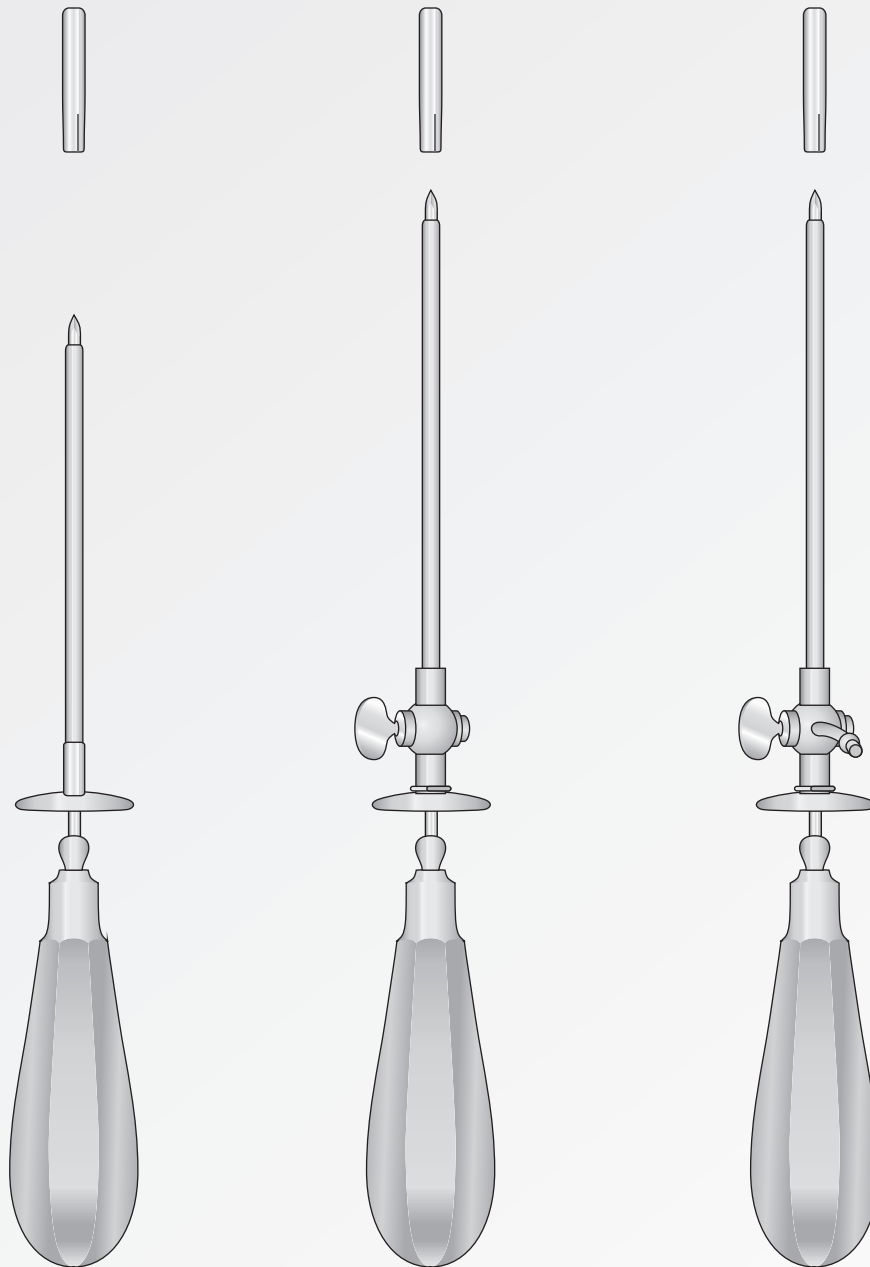

Ø mm Esterno
Outside Außen
Extérieur Exterior

Ø mm Interno
Inside Innen
Intérieur Interior

| | | STANDARD | STANDARD | STANDARD |
|-----|-----|--------------|--------------|--------------|
| 3,0 | 2,0 | TR-40 | TR-20 | TR-51 |
| 3,5 | 2,5 | TR-44 | TR-21 | TR-52 |
| 4,0 | 3,0 | TR-41 | TR-22 | TR-53 |
| 4,5 | 3,5 | TR-45 | TR-23 | TR-54 |
| 5,0 | 4,0 | TR-42 | TR-24 | TR-55 |
| 5,5 | 4,5 | TR-46 | TR-25 | TR-56 |
| 6,0 | 5,0 | TR-43 | TR-26 | TR-57 |
| | | 110 mm | 120 mm | 120 mm |

Trokare
Trocars
Trequarti
Tròcares
Trocarts

Für die gallenblase
For gall bladder
Per vescica biliare
Para vesicula biliar
Pour la vésicule biliaire

Krause Komplettsset
Krause set complete
Set completo Krause
Set completo Krause
Set complet Krause

Ø 5,5 mm

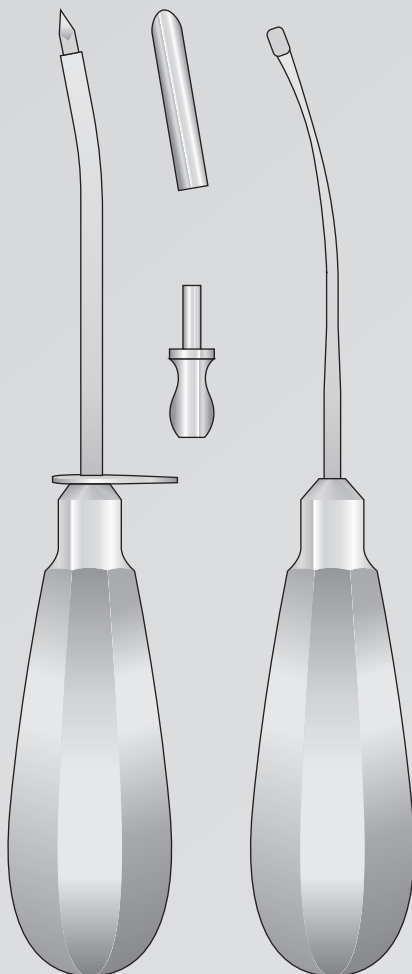

**KRAUSE
TR-35**
160 mm

Fig. 1

Fig. 2

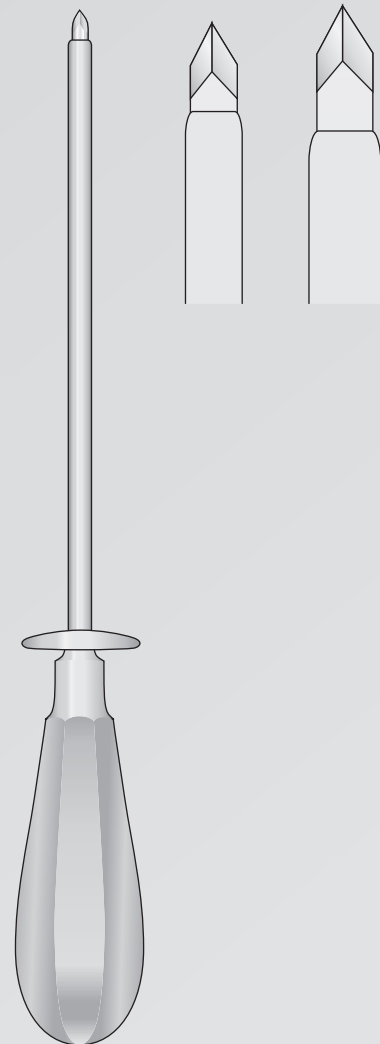

NELSON

| | |
|-----------|-----------|
| Ø mm | Ø mm |
| Außen | Innen |
| Outside | Inside |
| Esterno | Interno |
| Exterior | Interior |
| Extérieur | Intérieur |

| | | | |
|-----|-----|--------|--------------|
| 7,5 | 6,0 | Fig. 1 | TR-61 |
| 9,5 | 8,0 | Fig. 2 | TR-62 |

210 mm

Trokare
Trocars
Tre quarti
Tròcares
Trocarts

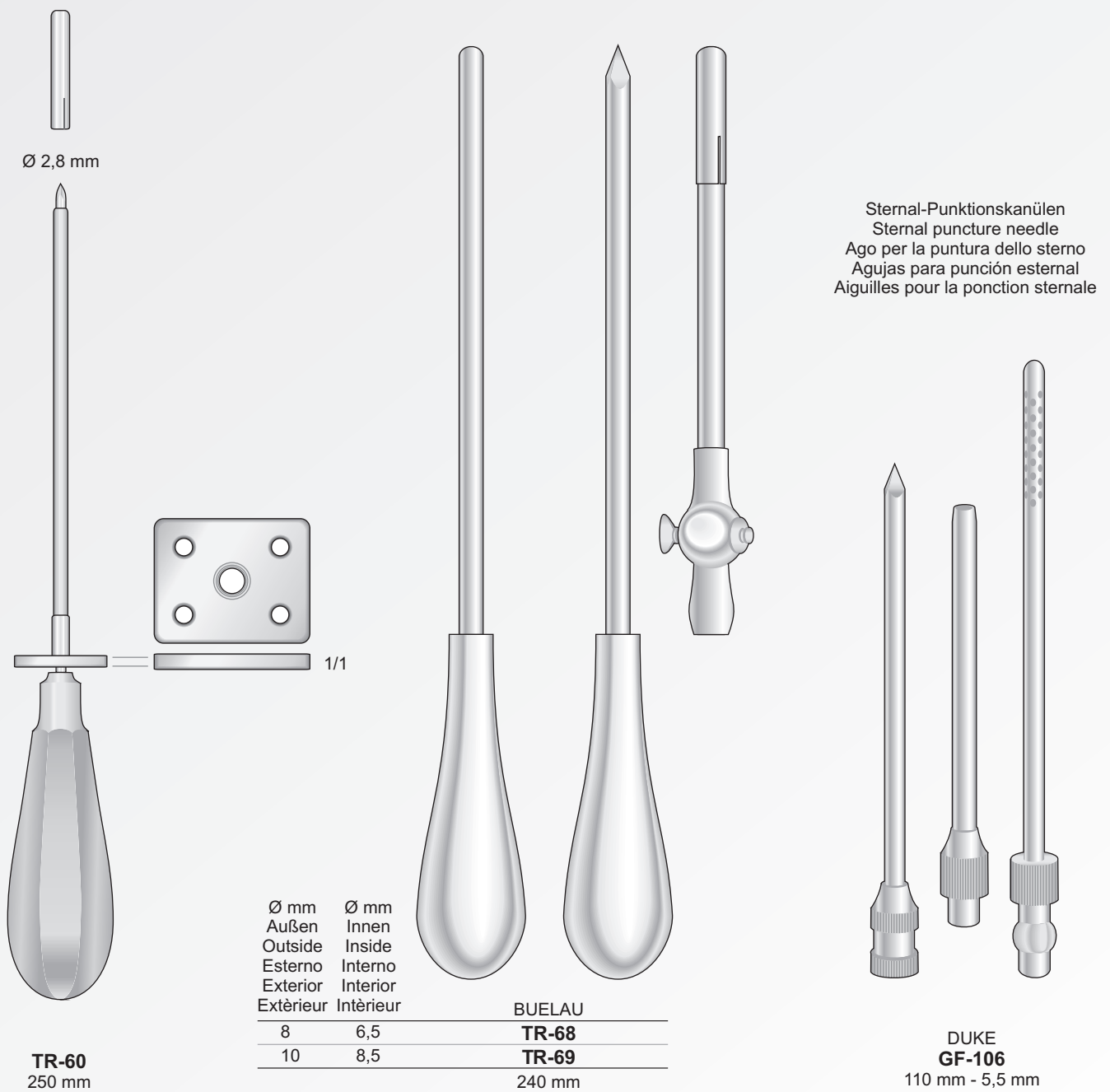

Sternal-Punktionskanülen
Sternal puncture needle
Ago per la puntura dello sterno
Agujas para punción esternal
Aiguilles pour la ponction sternale

| Ø mm | Ø mm |
|-----------|-----------|
| Außen | Innen |
| Outside | Inside |
| Esterno | Interno |
| Exterior | Interior |
| Extérieur | Intérieur |

| BUELAU | |
|--------|-----|
| 8 | 6,5 |
| 10 | 8,5 |

TR-68
240 mm

DUKE
GF-106
110 mm - 5,5 mm

Trokare
Trocars
Trequarti
Tròcares
Trocarts

Mit Holzgriff
With wooden handle
Manico in legno
Con mango de leña
Avec poignée en bois

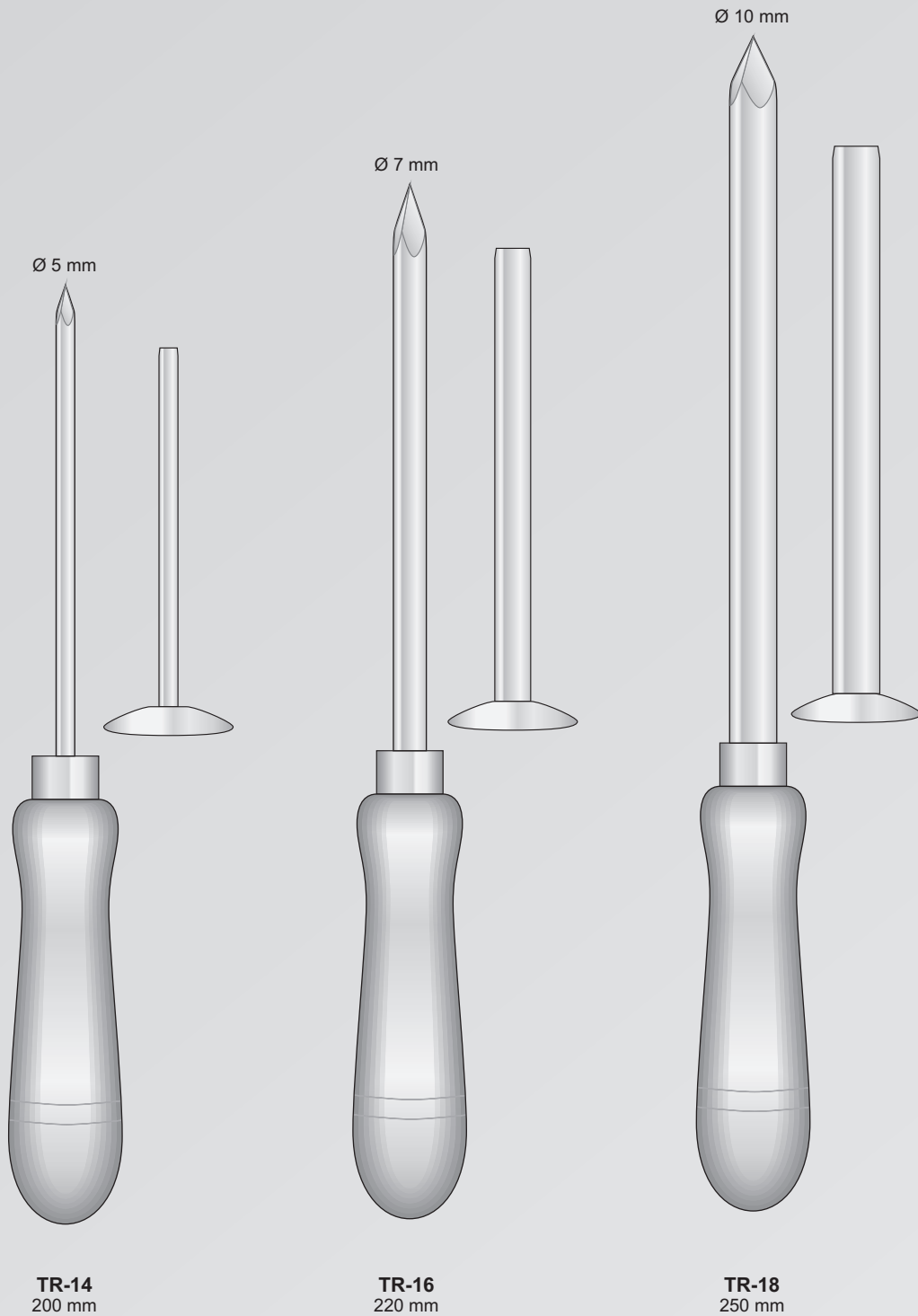

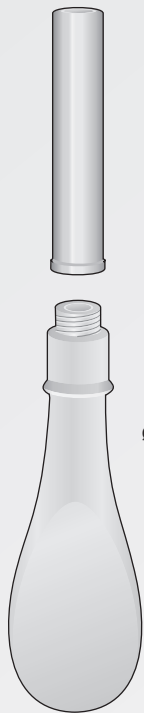

TR-49
130 mm

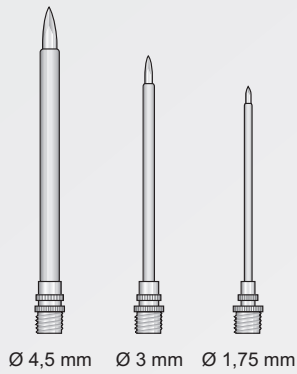

Satz zu 3 Stück
Set of 3 pieces
Trequarti con 3 punte
Juego de 3 piezas
Jeu de 3 pièces

Biopsie Kanülen
Biopsy needles
Aghi da biopsia
Agujas para biopsia
Aiguilles à biopsie



- MENGHINI
- OL-150** 1,00 x 35 mm
 - OL-151** 1,00 x 70 mm
 - OL-152** 1,20 x 70 mm
 - OL-153** 1,20 x 100 mm
 - OL-154** 1,40 x 70 mm
 - OL-155** 1,40 x 100 mm
 - OL-156** 1,60 x 70 mm
 - OL-157** 1,80 x 100 mm



- MENGHINI
- OL-158** 1,40 x 168 mm
 - OL-159** 1,80 x 168 mm



- QUINCKE
- OL-44** - 0,70 x 80 mm
 - OL-45** - 0,70 x 90 mm
 - OL-46** - 1,00 x 80 mm
 - OL-47** - 1,00 x 90 mm
 - OL-48** - 1,20 x 90 mm
 - OL-49** - 1,20 x 100 mm

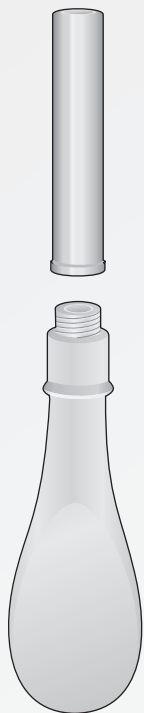

TR-50
130 mm

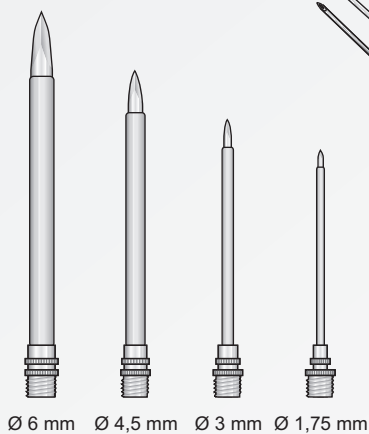

Satz zu 4 Stück
Set of 4 pieces
Trequarti con 4 punte
Juego de 4 piezas
Jeu de 4 pièces

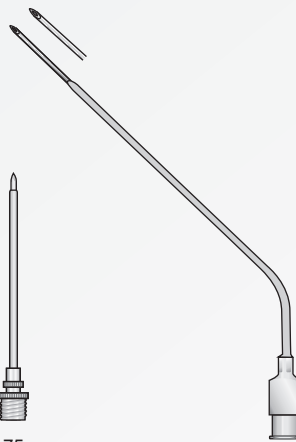

SEPTUN-NADEL
OL-04
110 mm



OL-05
110 mm



OL-01
120 mm



TUOHY
OL-41 - 1,30 x 80 mm
OL-42 - 1,50 x 80 mm
OL-43 - 1,65 x 80 mm

Biopsie Kanülen
Biopsy needles
Aghi da biopsia
Agujas para biopsia
Aiguilles à biopsie

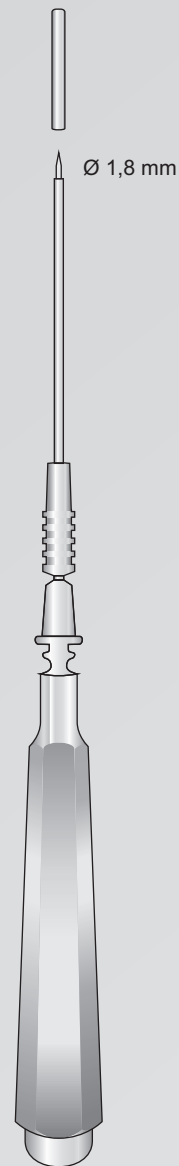

LICHTWITZ
TR-30
190 mm

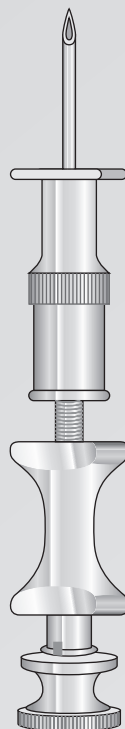

KLIMA-ROSEGGER
OL-40
1,80 x 35 mm



VERESS
GF-89/GF-90

Bohrinstrumente Pfieme
Boring instruments
Perforatori a mano
Perforadores para huesos
Instruments à perforer alènes

Knochenbiopsie instrumente
Bone Biopsy instruments
Strumento per prelievo osseo
Trepanador manual para biopsia ósea
Biopsie osseuse



FK-90

| | |
|-----------|-----------|
| Interno | Esterno |
| Inside | Outside |
| Innen | Außen |
| Intérieur | Extérieur |
| Interior | Exterior |
| Ø 3,9 mm | Ø 5 mm |



FK-91

| | |
|-----------|-----------|
| Interno | Esterno |
| Inside | Outside |
| Innen | Außen |
| Intérieur | Extérieur |
| Interior | Exterior |
| Ø 6,4 mm | Ø 8 mm |



FK-92

| | |
|-----------|-----------|
| Innen | Außen |
| Inside | Outside |
| Interno | Esterno |
| Interior | Exterior |
| Intérieur | Extérieur |
| Ø 3 mm | Ø 4 mm |

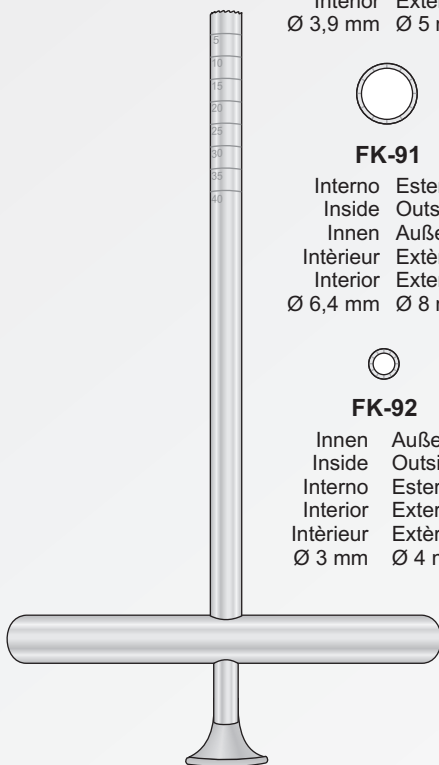

FK-90/FK-92
170 mm

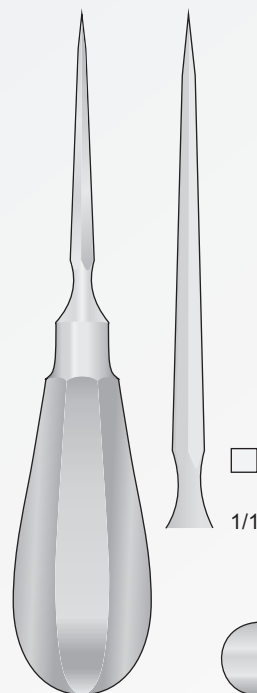

TR-77
140 mm

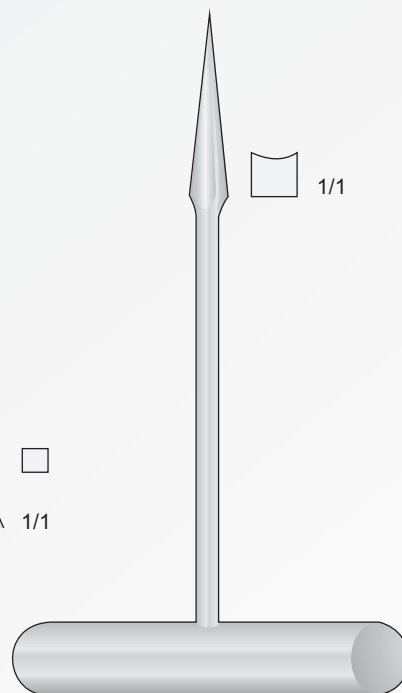

TR-76
140 mm

Punche da biopsia
Dermal punches
Haut-Trephinen
Tréphines cutanées
Trépanos cutâneos



KEYES
FL-150/FL-153
100 mm

| | |
|---------------|---|
| 3 mm | ○ |
| FL-150 | ○ |
| 4 mm | ○ |
| FL-151 | ○ |
| 5 mm | ○ |
| FL-152 | ○ |
| 6 mm | ○ |
| FL-153 | ○ |

Biopsie instrumente
Biopsy instruments
Strumenti per prelievo osseo
Trepanador manual
Biopsie osseuse

FK-100

Set completo di 4 pezzi
Set complete with 4 pieces
Kompletset mit 4 Teilen
Set complet avec 4 pièces
Set completo con 4 piezas

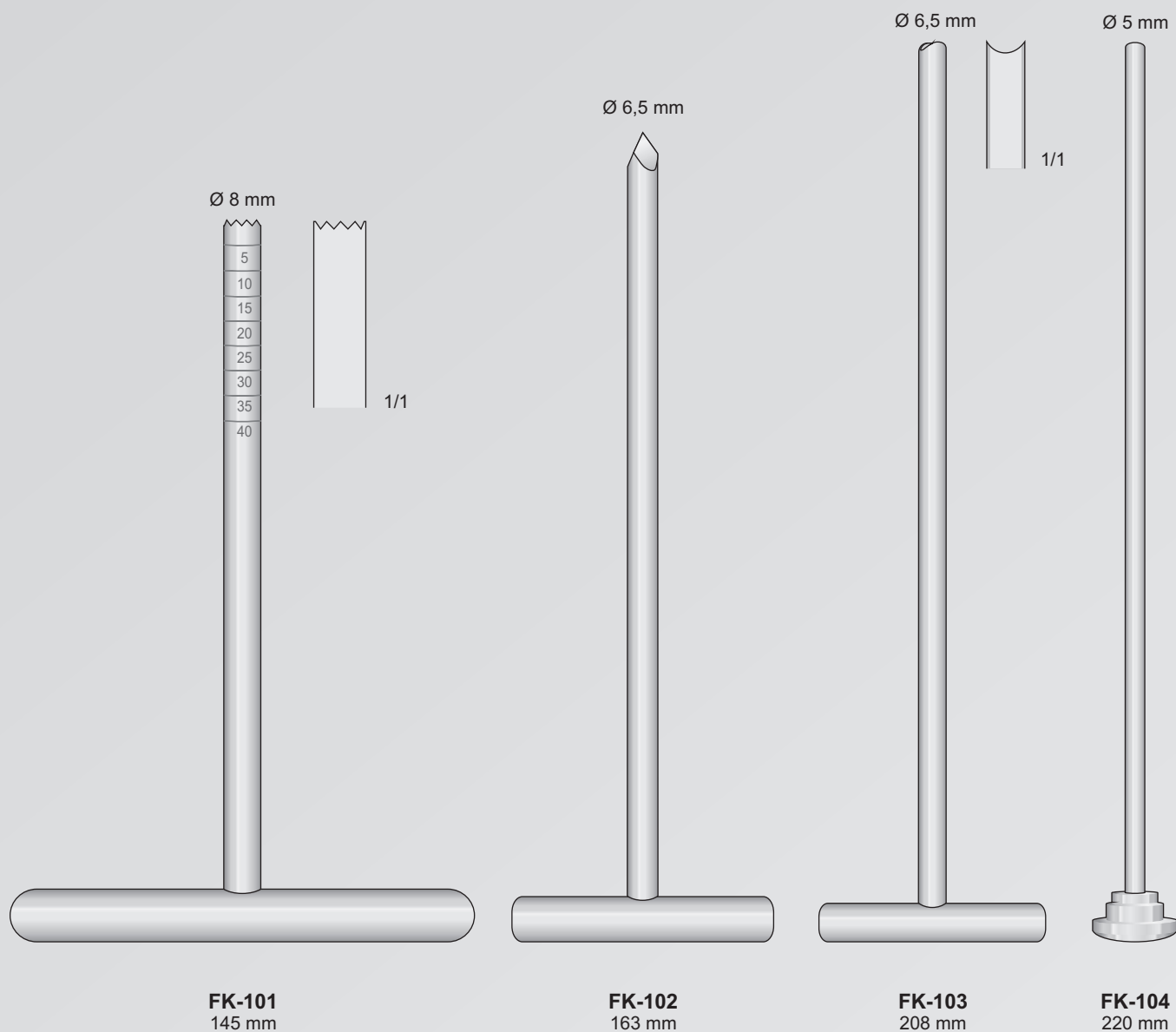

FK-105

Set completo di 4 pezzi
Set complete with 4 pieces
Kompletset mit 4 Teilen
Set complet avec 4 pièces
Set completo con 4 piezas

Ø 5 mm

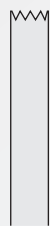

1/1

Ø 3,9 mm



Ø 3,9 mm



1/1

Ø 3 mm



FK-106
145 mm

FK-107
163 mm

FK-108
208 mm

FK-109
220 mm



BONTEMPI
CHIRURGISCHE INSTRUMENTE

Hämmer, Flachmeißel, Knochenfeilen-Raspeln
Mallets, Chisels, Bone Files-Rasps
Martelli, Scalpelli, Lime e Raspe
Martillos, Cinceles Limas para huesos
Maillets, Ciseaux-Burins, Limes-Râpes

Chirurgische Hämmer
Surgical mallets
Martelli chirurgici
Martillos quirurgicos
Maillets chirurgicaux

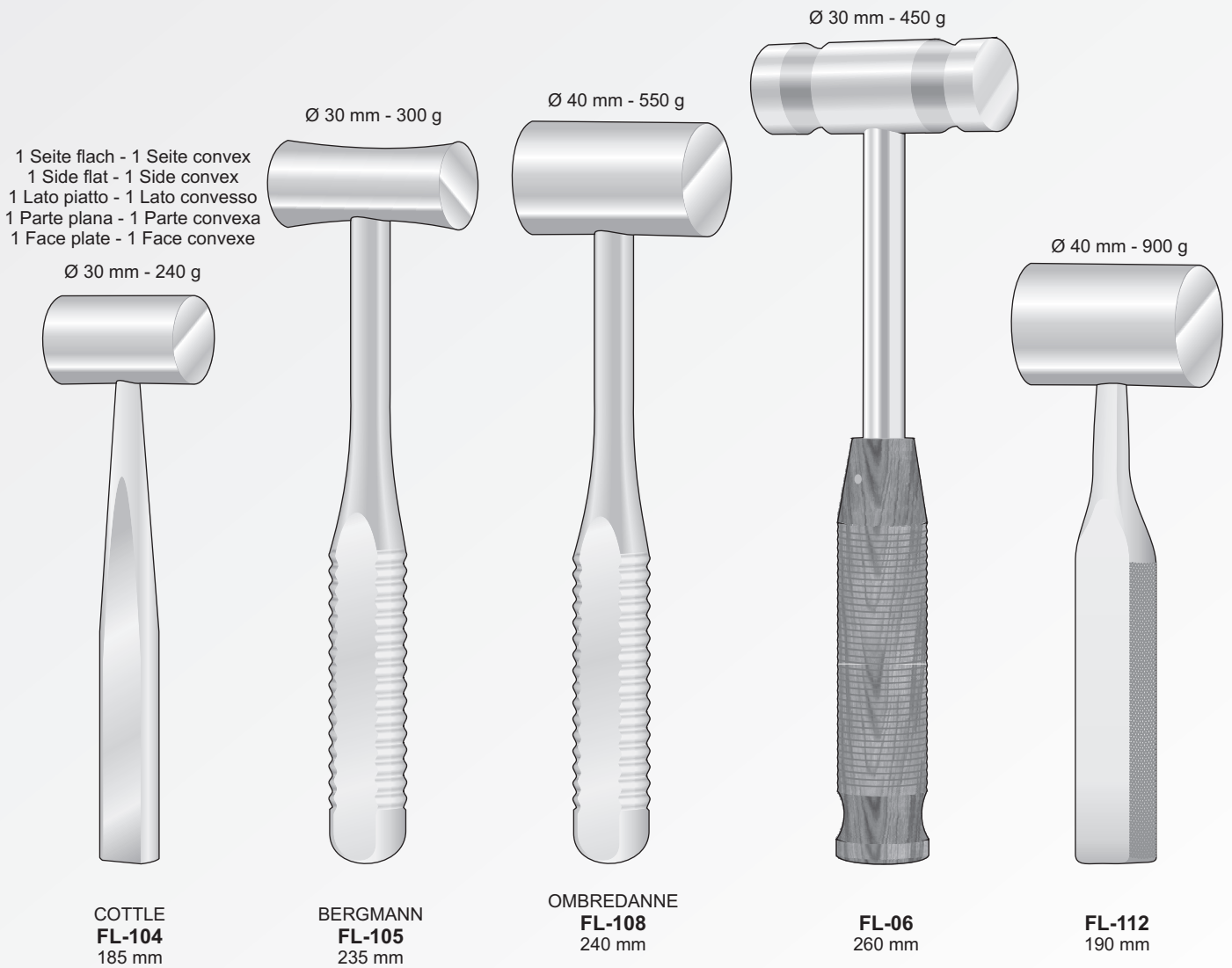

Chirurgische Hämmer
Surgical mallets
Martelli chirurgici
Martillos quirurgicos
Maillets chirurgicaux

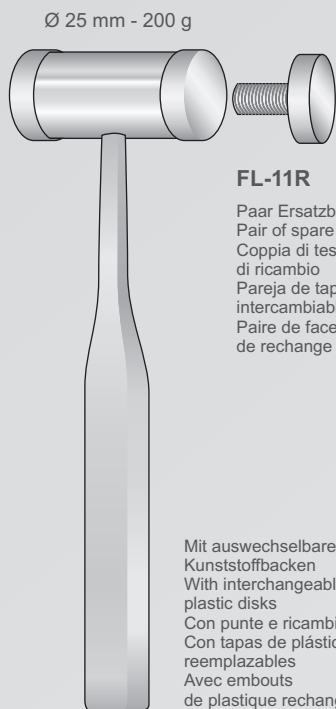
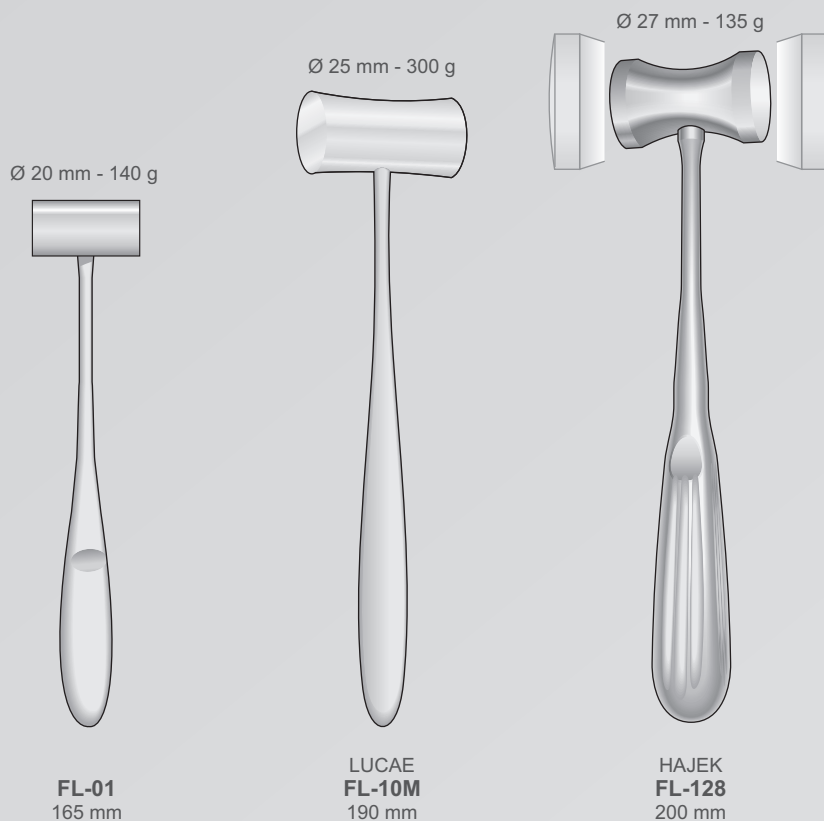

FL-11R

Paar Ersatzbacken
Pair of spare faces
Coppia di teste
di ricambio
Pareja de tapas
intercambiables
Paire de faces
de rechange

Mit auswechselbaren
Kunststoffbacken
With interchangeable
plastic disks
Con punte e ricambi in teflon
Con tapas de plástico
reemplazables
Avec embouts
de plastique rechangeables

MEAD
FL-11
200 mm

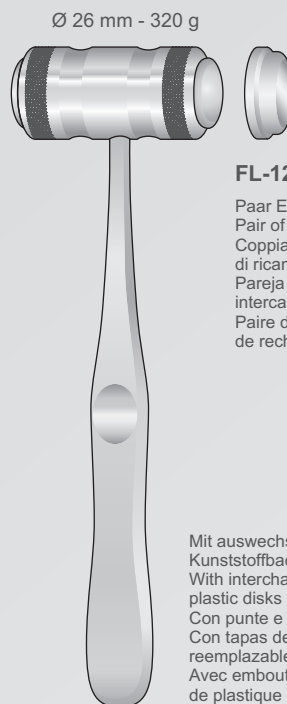

FL-12R

Paar Ersatzbacken
Pair of spare faces
Coppia di teste
di ricambio
Pareja de tapas
intercambiables
Paire de faces
de rechange

Mit auswechselbaren
Kunststoffbacken
With interchangeable
plastic disks
Con punte e ricambi in teflon
Con tapas de plástico
reemplazables
Avec embouts
de plastique rechangeables

MEAD
FL-12
190 mm

Stosel
Tampers
Battitori
Batidor
Pilons



CASPAR
FF-147/FF-149
200 mm

-  **FF-147**
Ø3 mm
-  **FF-148**
Ø5 mm
-  **FF-149**
Ø8 mm

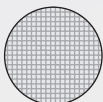
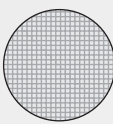

FL-253/FL-255
200 mm

-  **FL-253**
Ø12 mm
-  **FL-254**
Ø14 mm
-  **FL-255**
Ø16 mm



FL-20
155 mm

-  Ø 3 mm



FL-21
155 mm

-  Ø 5 mm



FL-22
155 mm

-  Ø 7 mm



FL-30
155 mm

-  Ø 2 mm



FL-31
155 mm

-  Ø 4 mm



FL-33
155 mm

-  Ø 3 mm







FL-35
155 mm

-  Ø 5 mm



SYPERT
FL-256/FL-259
290 mm

-  **FL-256**
3x8 mm
-  **FL-257**
4x10 mm
-  **FL-258**
5x15 mm
-  **FL-259**
6x20 mm

Osteotome
Osteotomes
Osteotomi
Osteòtomos
Ostèotomes

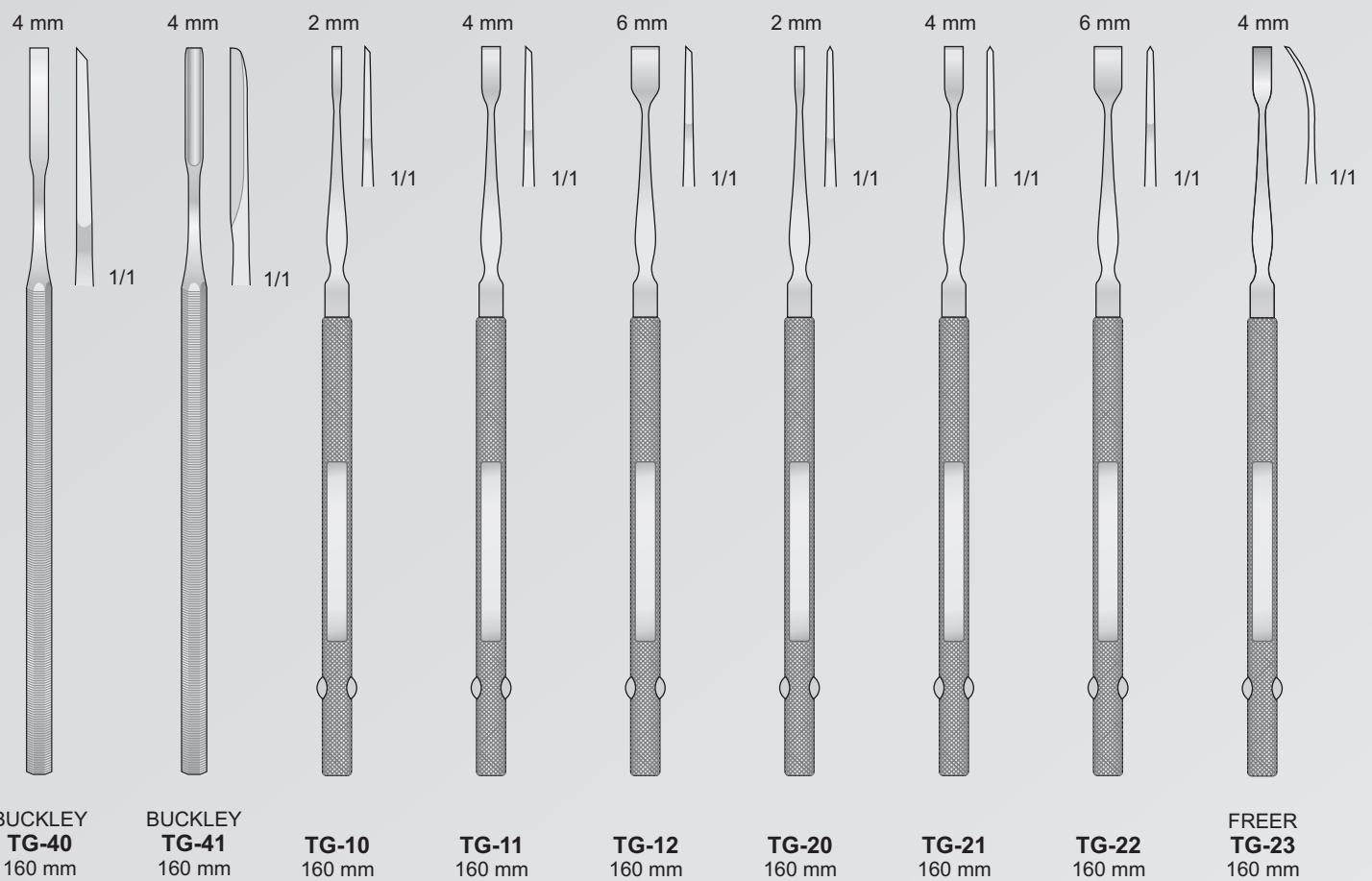

Osteotome - Hohlmeissel
Osteotomes - Gouges
Osteotomi - Scalpelli
Osteótomos - Cinceles
Ostéotomes - Scalpel

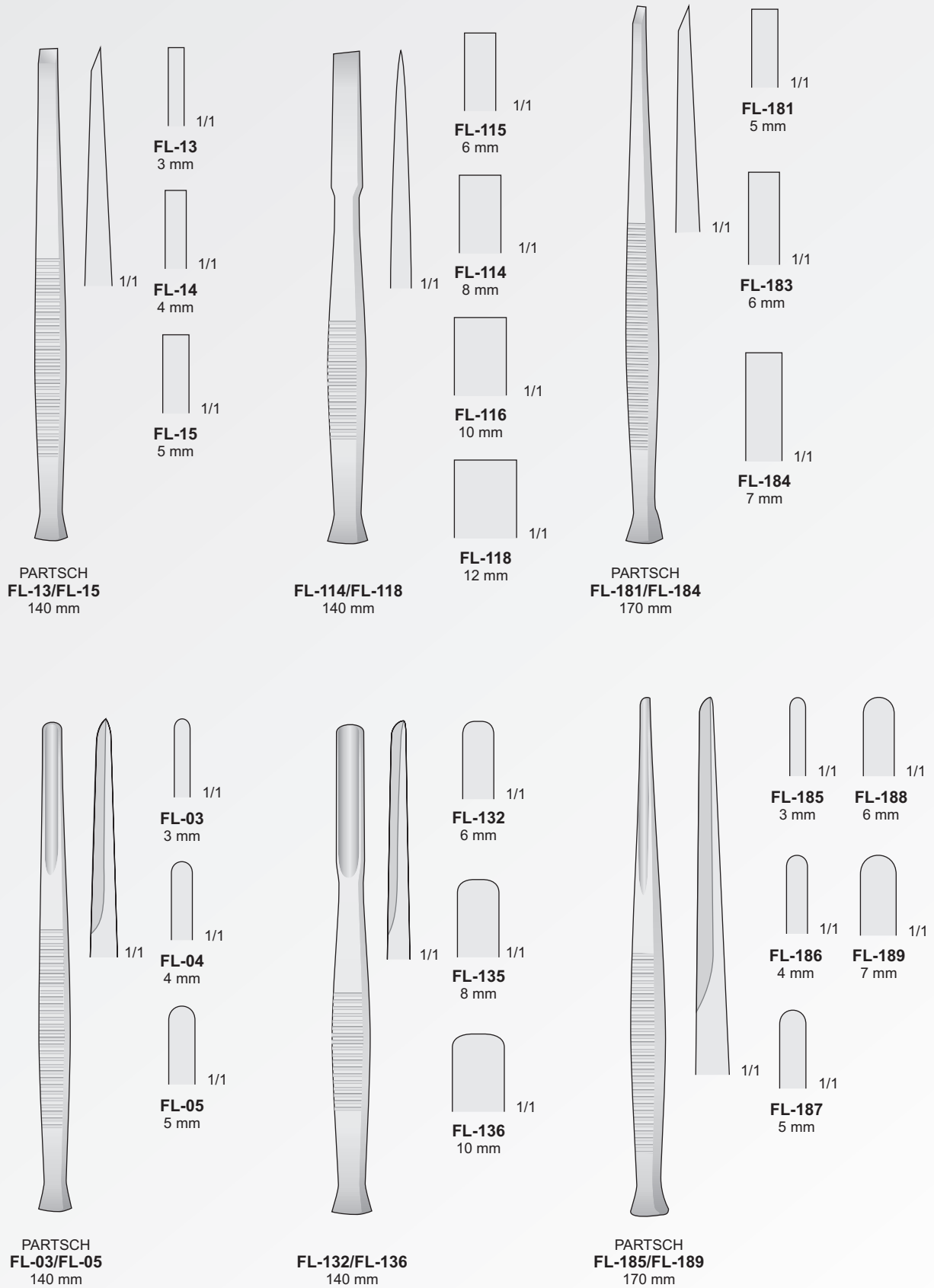

Osteotome
Osteotomes
Osteotomi
Osteòtomos
Ostèotomes

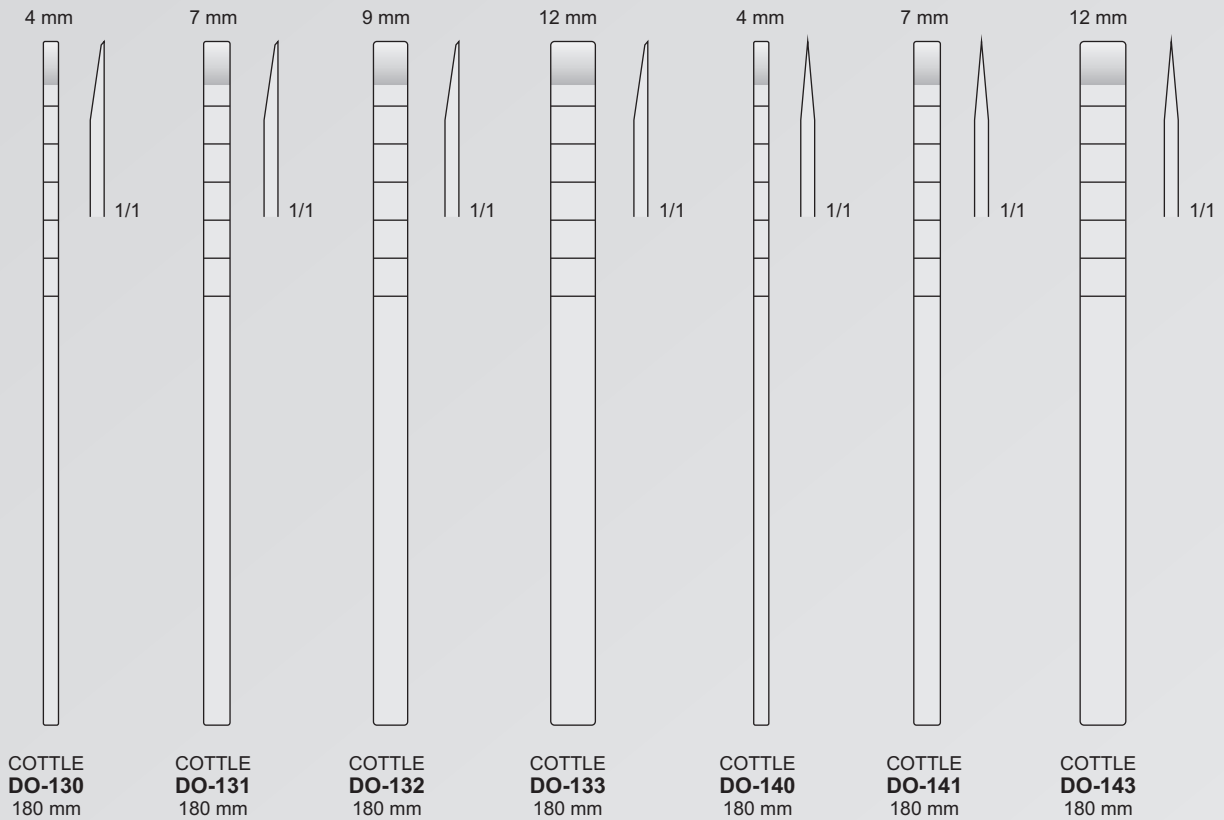
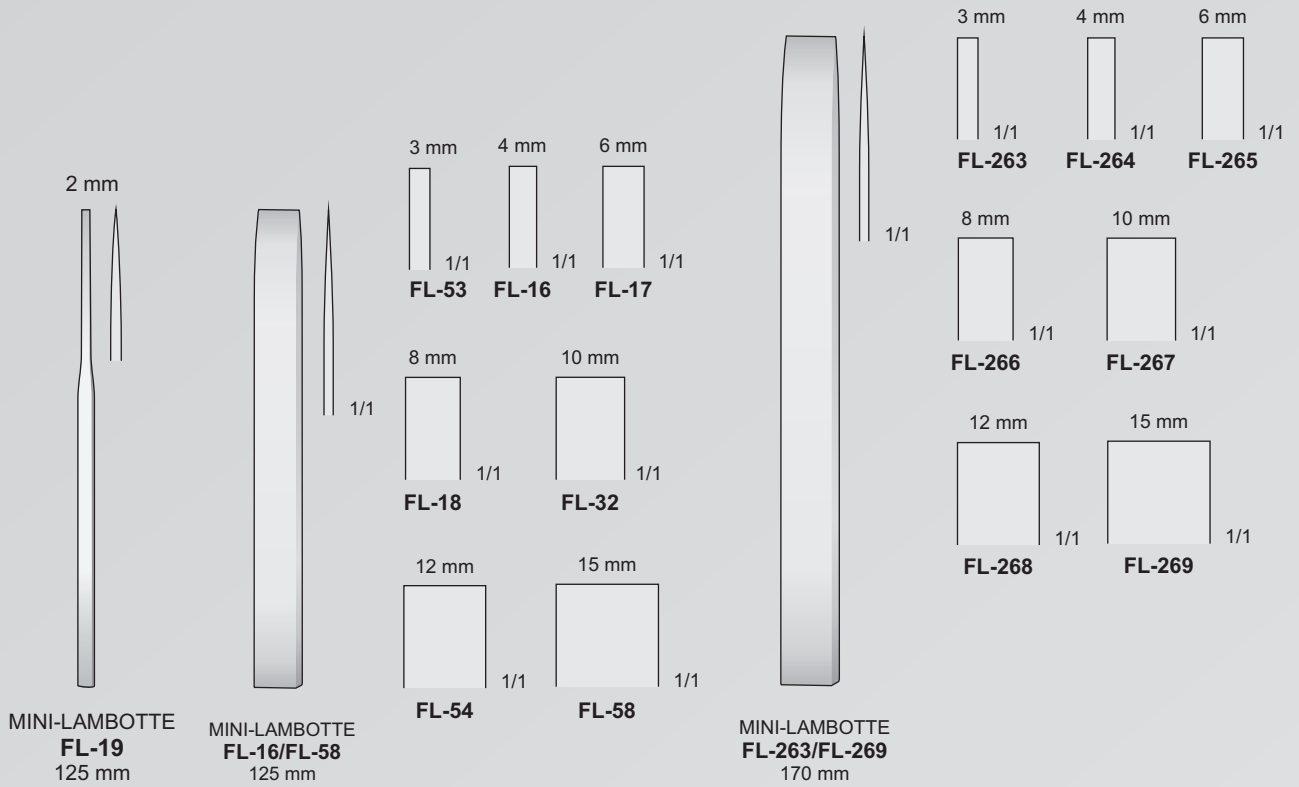

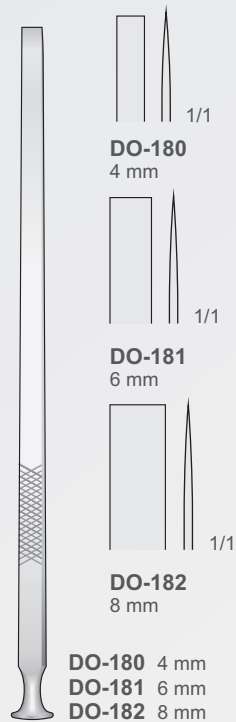

EPKER
DO-180/DO-182
180 mm

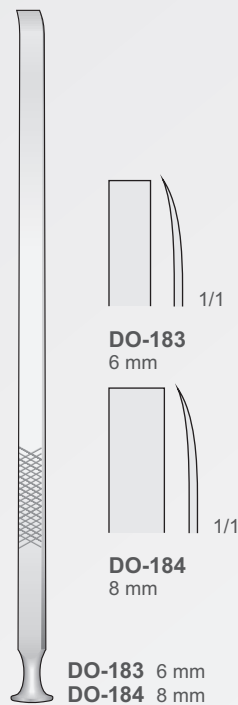

EPKER
DO-183/DO-184
180 mm

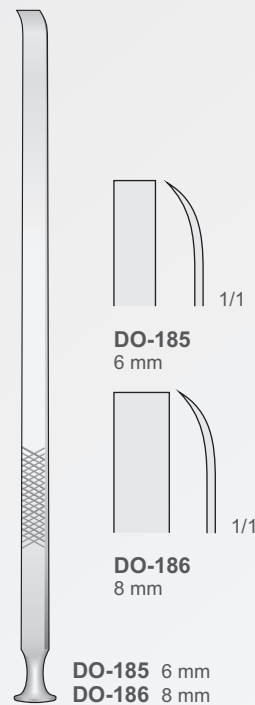

EPKER
DO-185/DO-186
180 mm

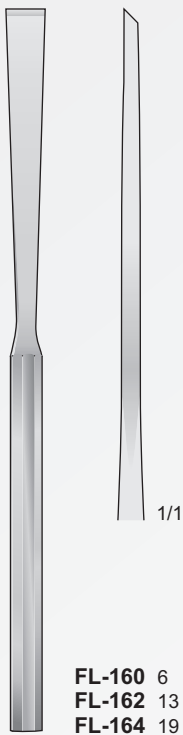

HIBBS
FL-160/FL-164
230 mm

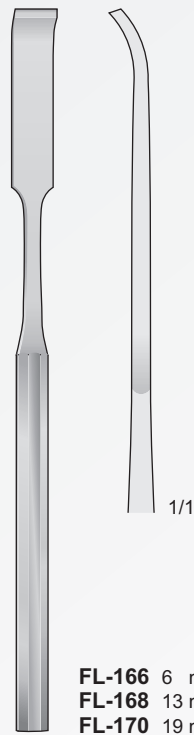

HIBBS
FL-166/FL-170
230 mm

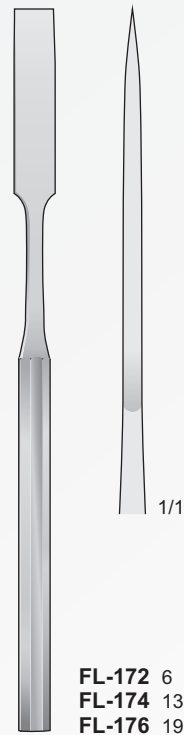

HIBBS
FL-172/FL-176
230 mm

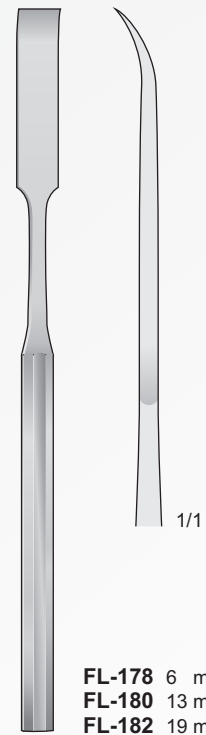

HIBBS
FL-178/FL-182
230 mm

Osteotome - Hohlmeissel
Osteotomes - Gouges
Osteotomi - Scalpelli
Osteótomos - Cinceles
Ostéotomes - Scalpel

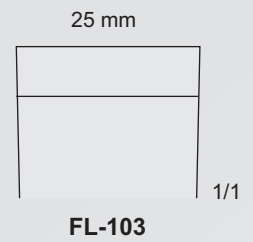
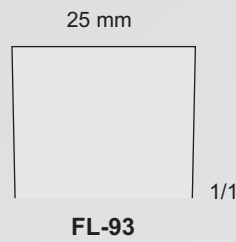
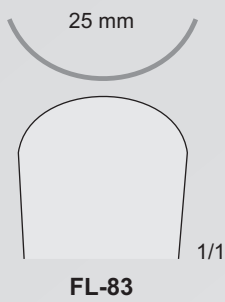
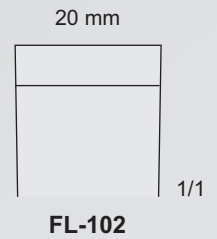
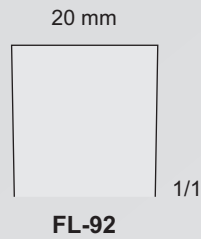
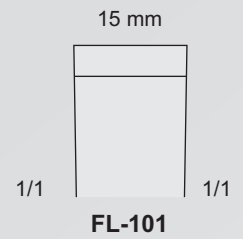
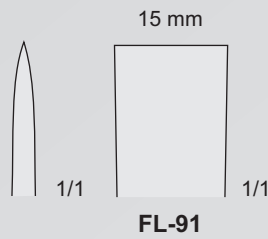
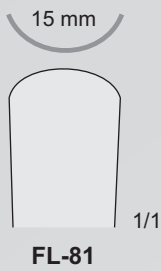
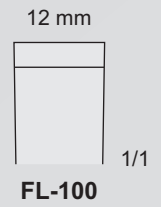
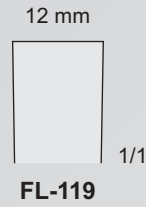
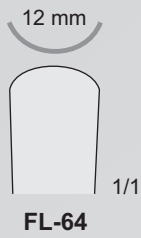
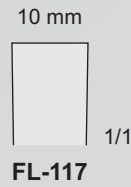
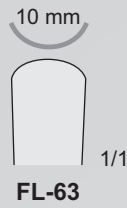

STILLE
FL-63/FL-83
200 mm



STILLE
FL-91/FL-119
200 mm



STILLE
FL-100/FL-110
200 mm

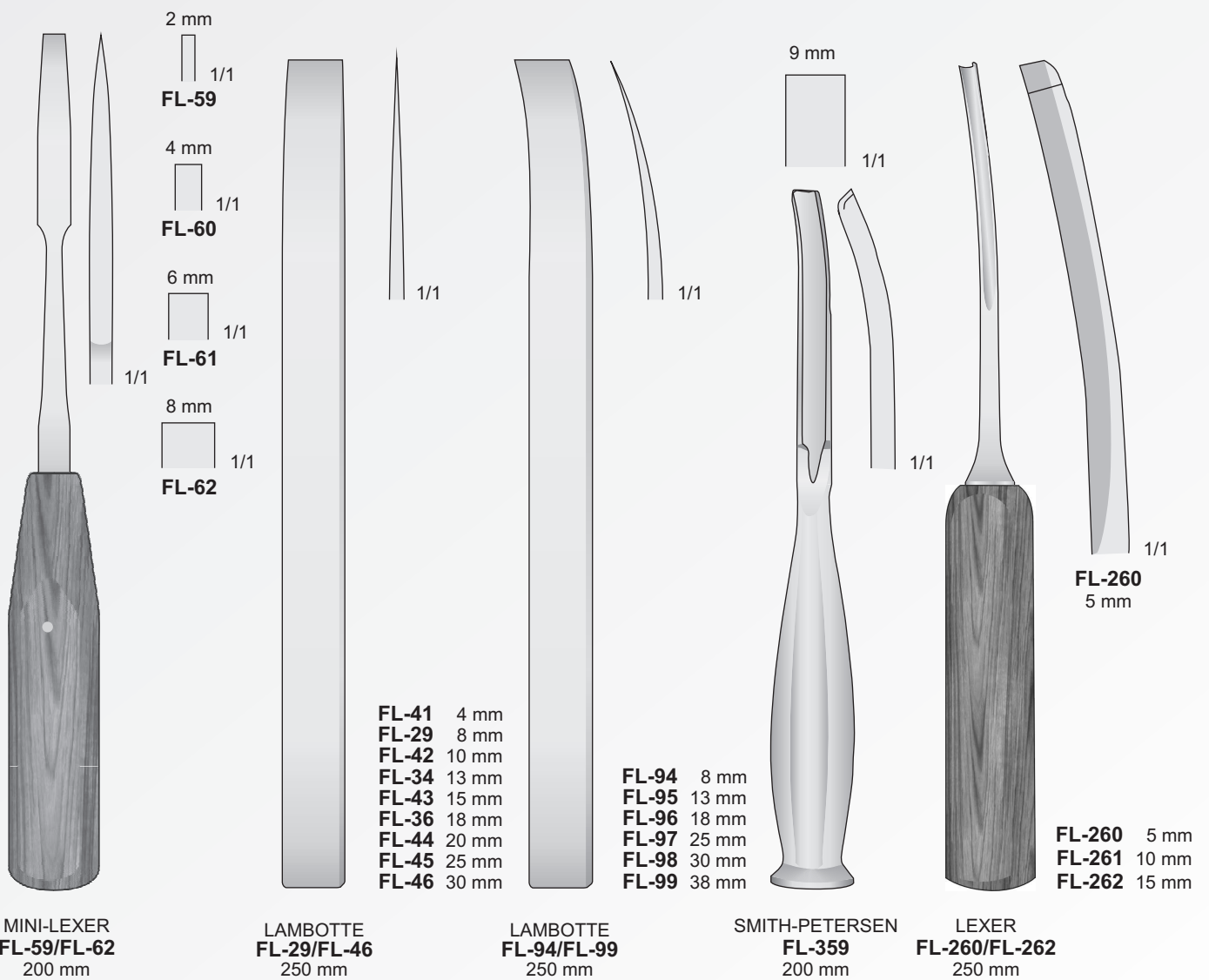

Osteotome
Osteotomes
Osteotomi
Osteòtomos
Ostèotomes

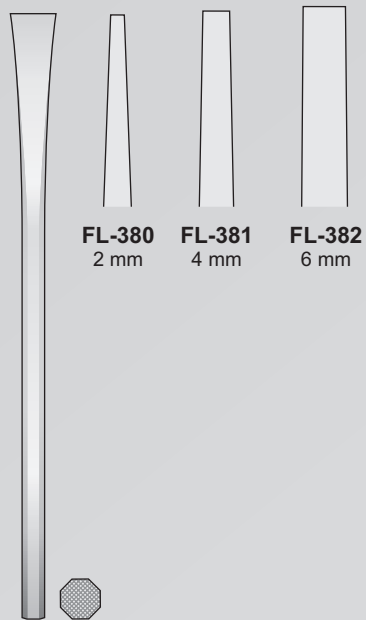

SHEEHAN
FL-380/FL-382
160 mm

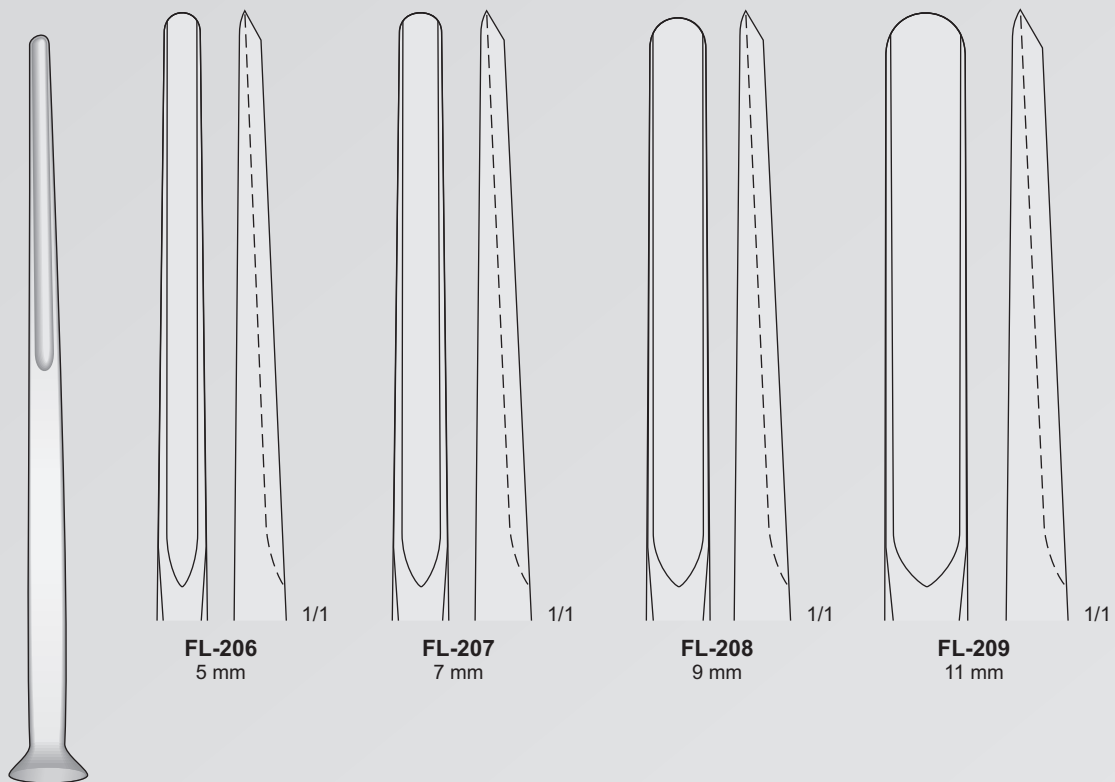

ALEXANDER
FL-206/FL-209
170 mm

Osteotome
Osteotomes
Osteotomi
Osteòtomos
Ostèotomes

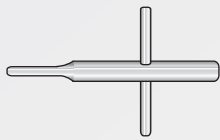

FL-84
90 mm

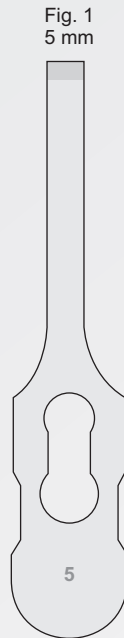

FL-86
85 mm

1/1



FL-87
85 mm

1/1

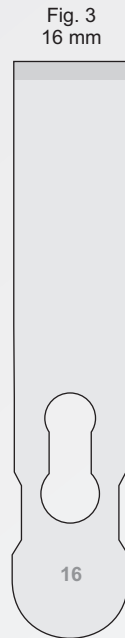

FL-88
85 mm

1/1

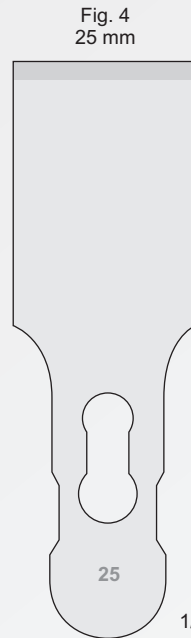

FL-89
85 mm

1/1



Meißel
Chisel
Scalpelli
Cinceles
Ciseaux-burins



FL-85
190 mm

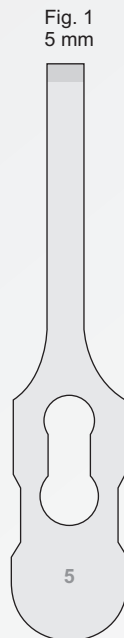

FL-286
85 mm

1/1



FL-287
85 mm

1/1



FL-288
85 mm

1/1

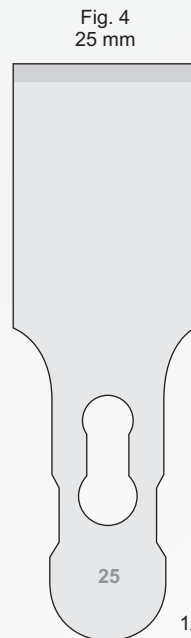

FL-289
85 mm

1/1



Osteotom
Gouge
Osteotomi
Cubias
Gouges

Raspeln
Rasps
Raspe
Escofinas
Râpes



FK-89
170 mm

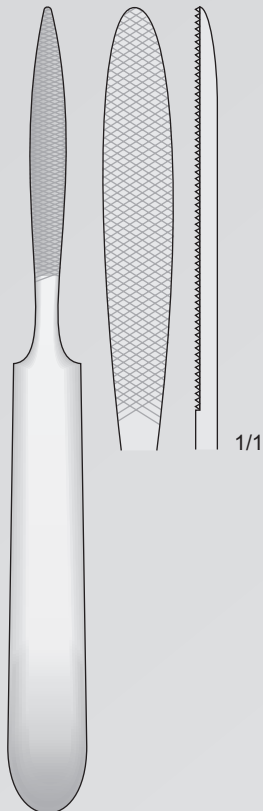

**JOSEPH
FK-193**
160 mm

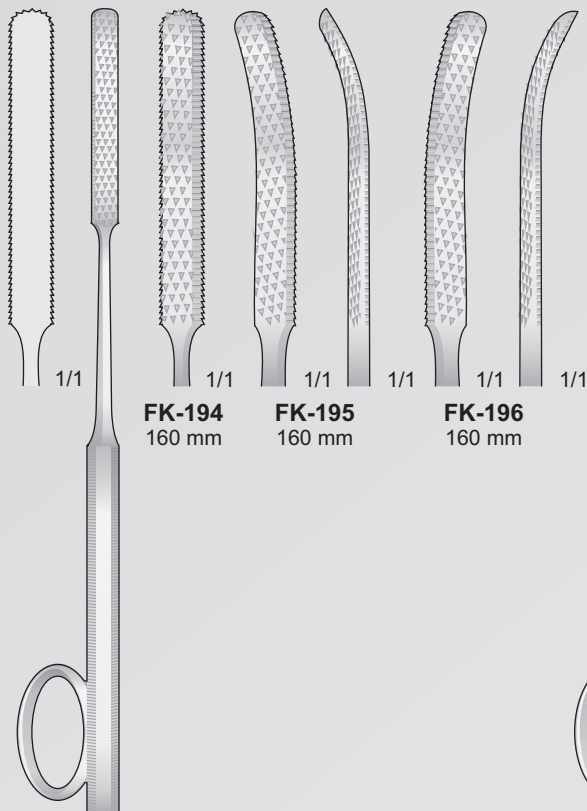

**GALLAHER
FK-194/FK-196**
160 mm

FK-194
160 mm

FK-195
160 mm

FK-196
160 mm

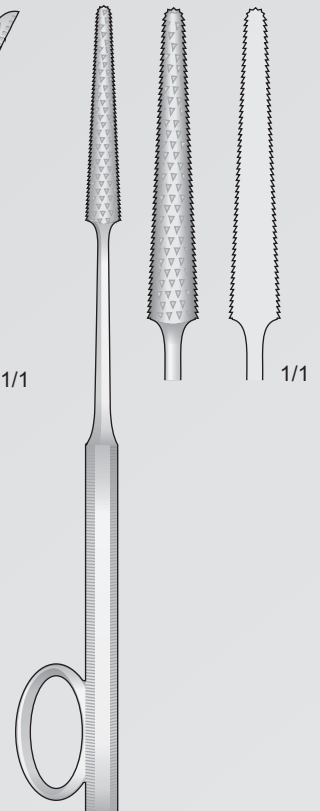

**GOOD
FK-199**
160 mm

Raspeln
Rasps
Raspe
Escofinas
Râpes

Fig. 67

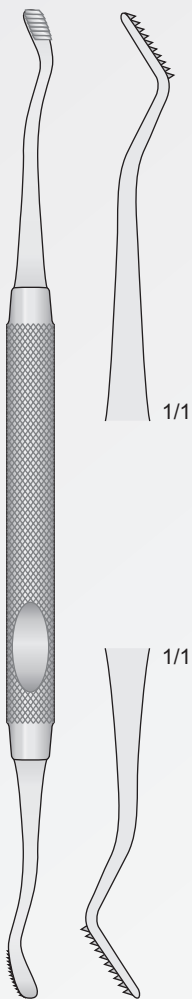

HOWARD
DO-1
180 mm

Fig. 45

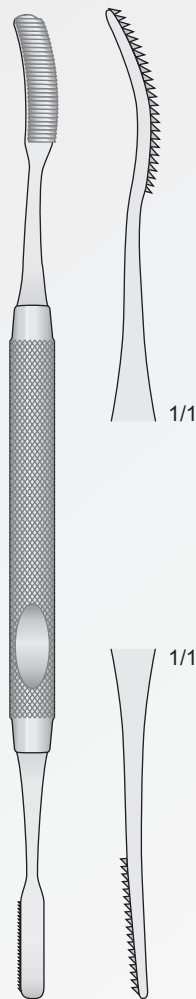

MILLER
DO-2
185 mm

Fig. 52

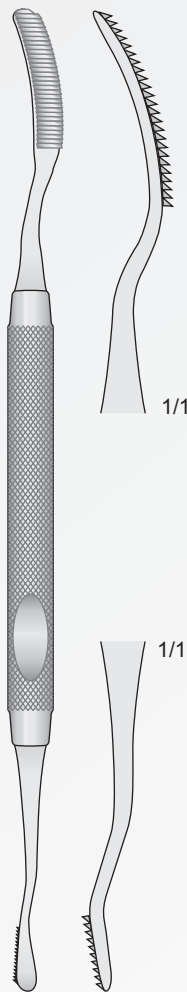

MILLER
DO-3
180 mm



DO-267
190 mm



JOSEPH
DO-109
190 mm

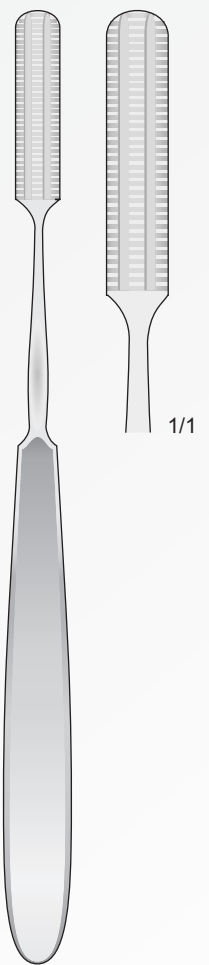

MALTZ
DO-179
180 mm

Raspeln
Rasps
Raspe
Escofinas
Râpes

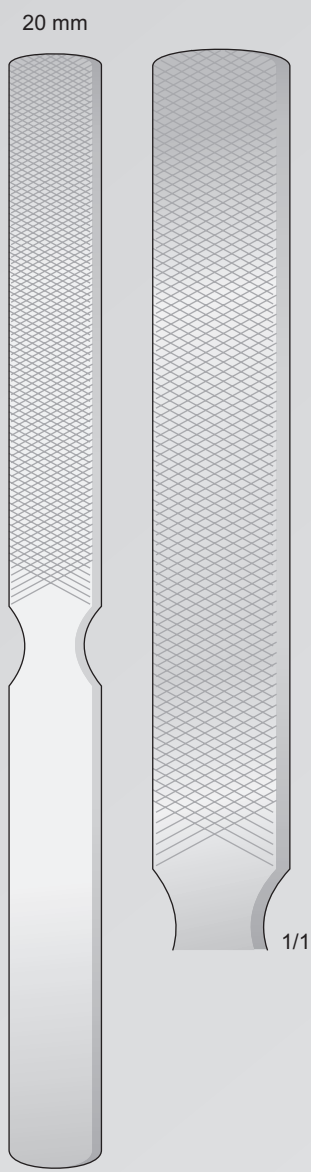

FK-119
220 mm

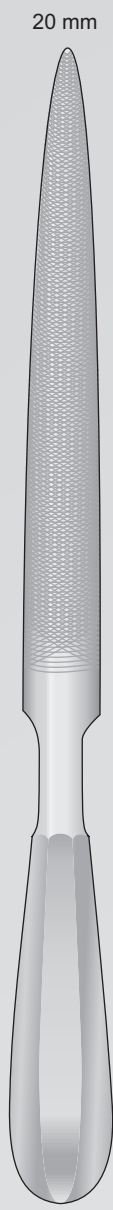

FK-85
295 mm

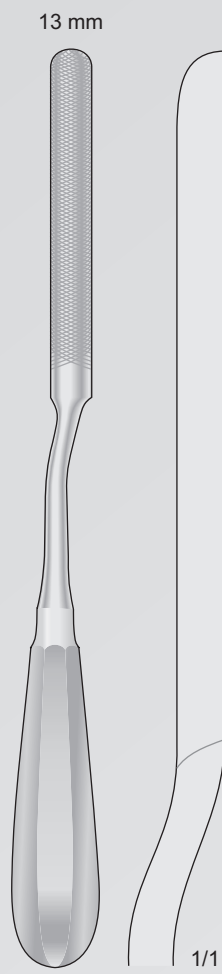

FK-86
240 mm

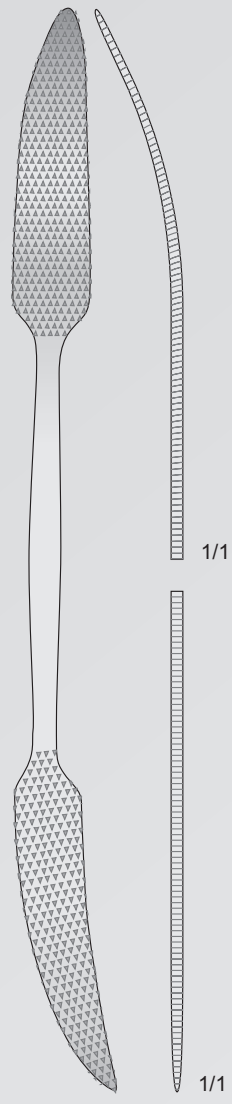

PUTTI
FK-94
270 mm

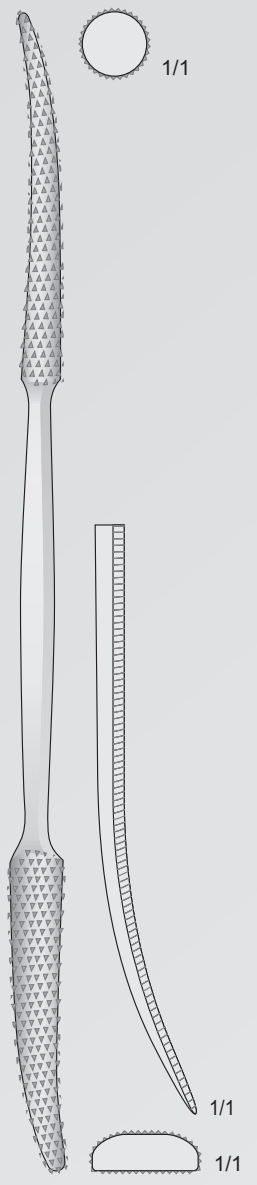

PUTTI
FK-95
300 mm

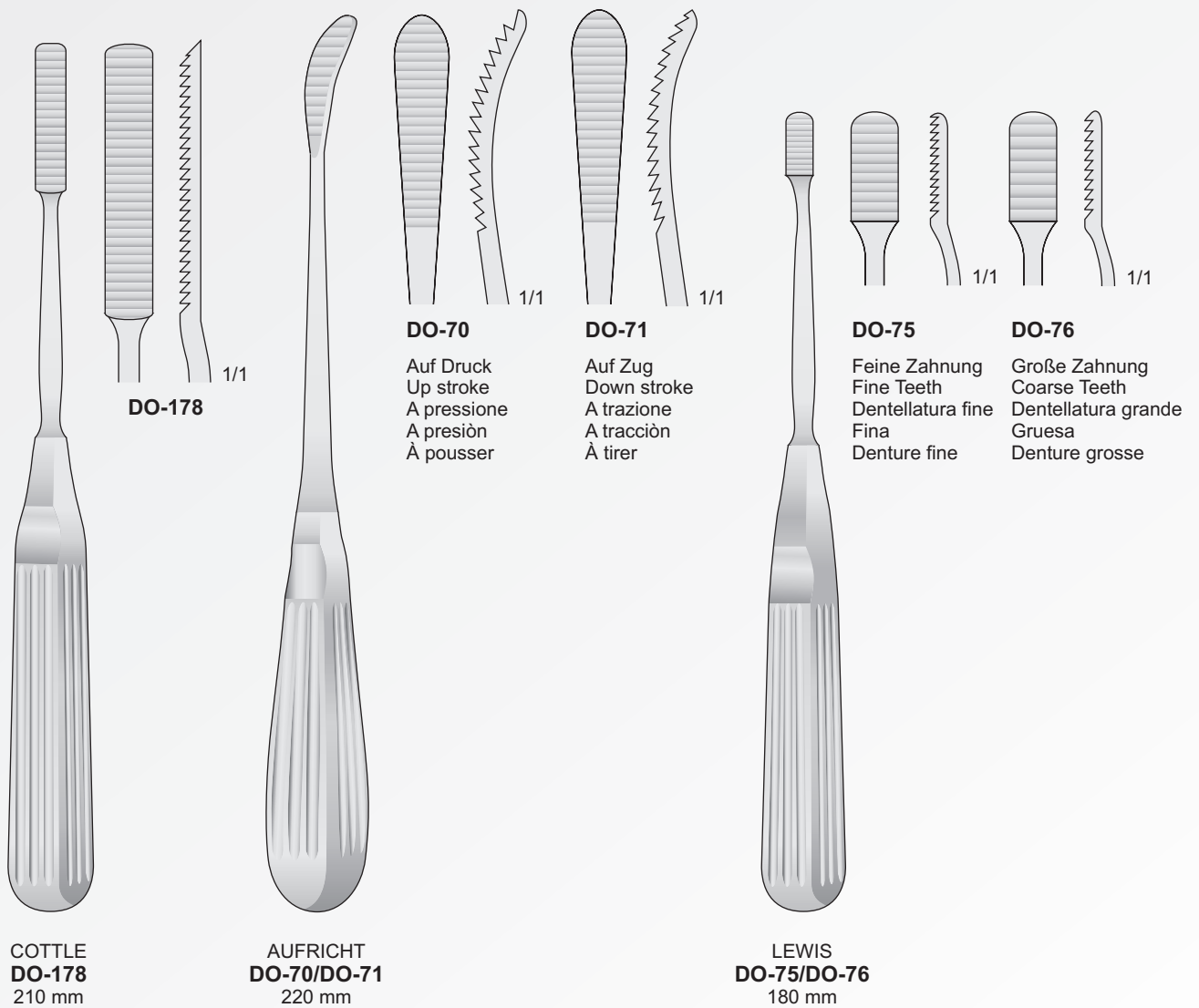

Raspeln
Rasps
Raspe
Escofinas
Râpes

8 mm



8 mm

FK-96
210 mm

2 mm



5 mm

FK-97
210 mm



1/1



1/1

8 mm

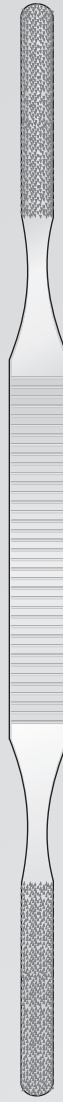

8 mm

FK-98
210 mm

8 mm

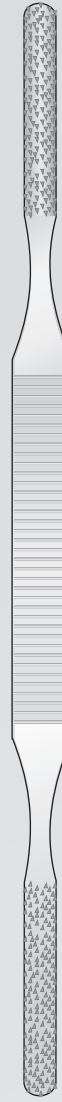

8 mm

FK-99
210 mm

Raspeln
Rasps
Raspe
Escofinas
Râpes

Feilen
File
Lima
Lima
Lime

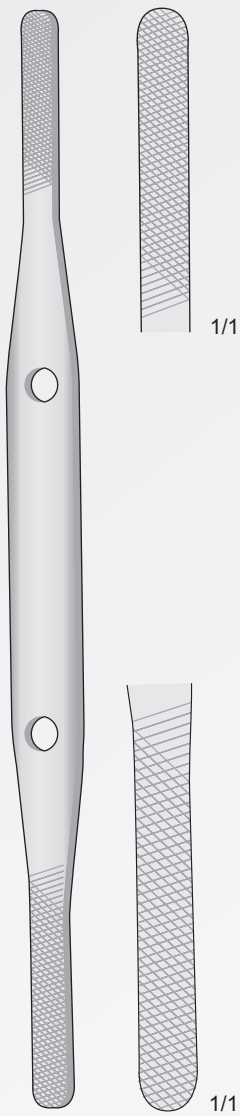

FOMON
DO-168
210 mm

Raspel
Rasp
Raspa
Raspador
Râpe

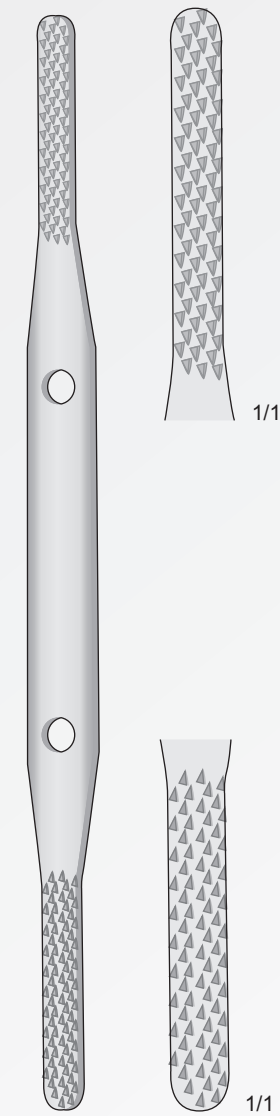

FOMON
DO-169
210 mm



FOMON
FK-175
210 mm

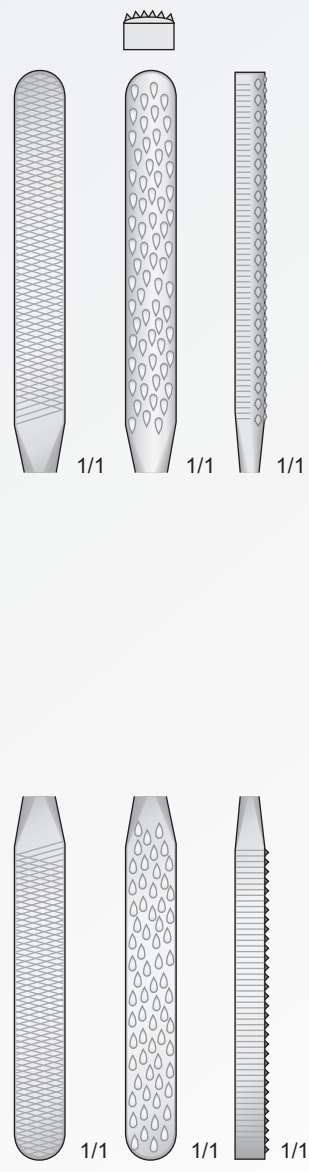

CONVERSE
FK-174
180 mm

Knochenchirurgie
Bone Surgery
Chirurgia ossea
Cirugia òsea
Chirurgie osseuse

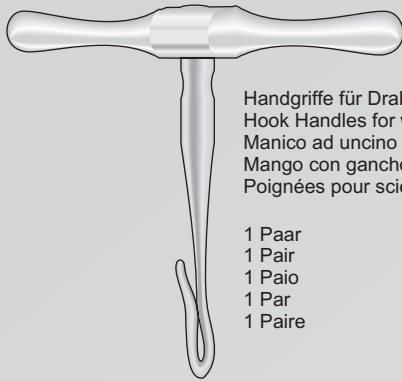

Handgriffe für Drahtsägen
Hook Handles for wire saws
Manico ad uncino per sega
Mango con gancho para sierras de hilo
Poignées pour scies

1 Paar
1 Pair
1 Paio
1 Par
1 Paire

GIGLI
FK-11



OLIVECRONA-GIGLI
FK-13 300 mm
FK-14 500 mm

Drahtsägen
Wire Saws
Fili per sega
Sierras de hilo
Fils-Scies

Acciaio
Rostfrei
Stainless
Inox

5/1

LS-300
Komplett mit 3 Sägen
Complete with 3 saws
Completa con 3 seghe
Completo con 3 sierras
Complet avec 3 scies

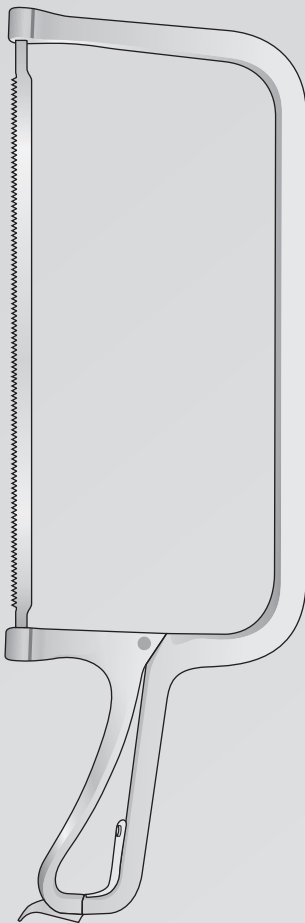

COLLIN
LS-300
390 mm

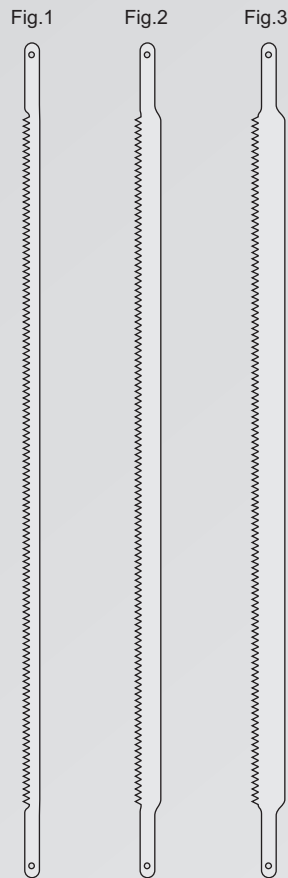

LS-301 280 mm
LS-302 280 mm
LS-303 280 mm



LINDEMANN
FK-243
200 mm



1/1



LANGENBECK
FK-244
235 mm

Handbohrapparate
Hand Bone Drills
Trapani a mano per ossa
Perforadores de mano
Perforateurs à main

Handbohrfutter
Drilling Chucks
Perforatori a mano con mandrino
Perforadores para huesos
Perforateurs à os

LS-233
Komplett mit - Complete with
Completo con - Completos con
Completos avec:
1 **LS-236**
1 **LS-229**
1 **LS-241**

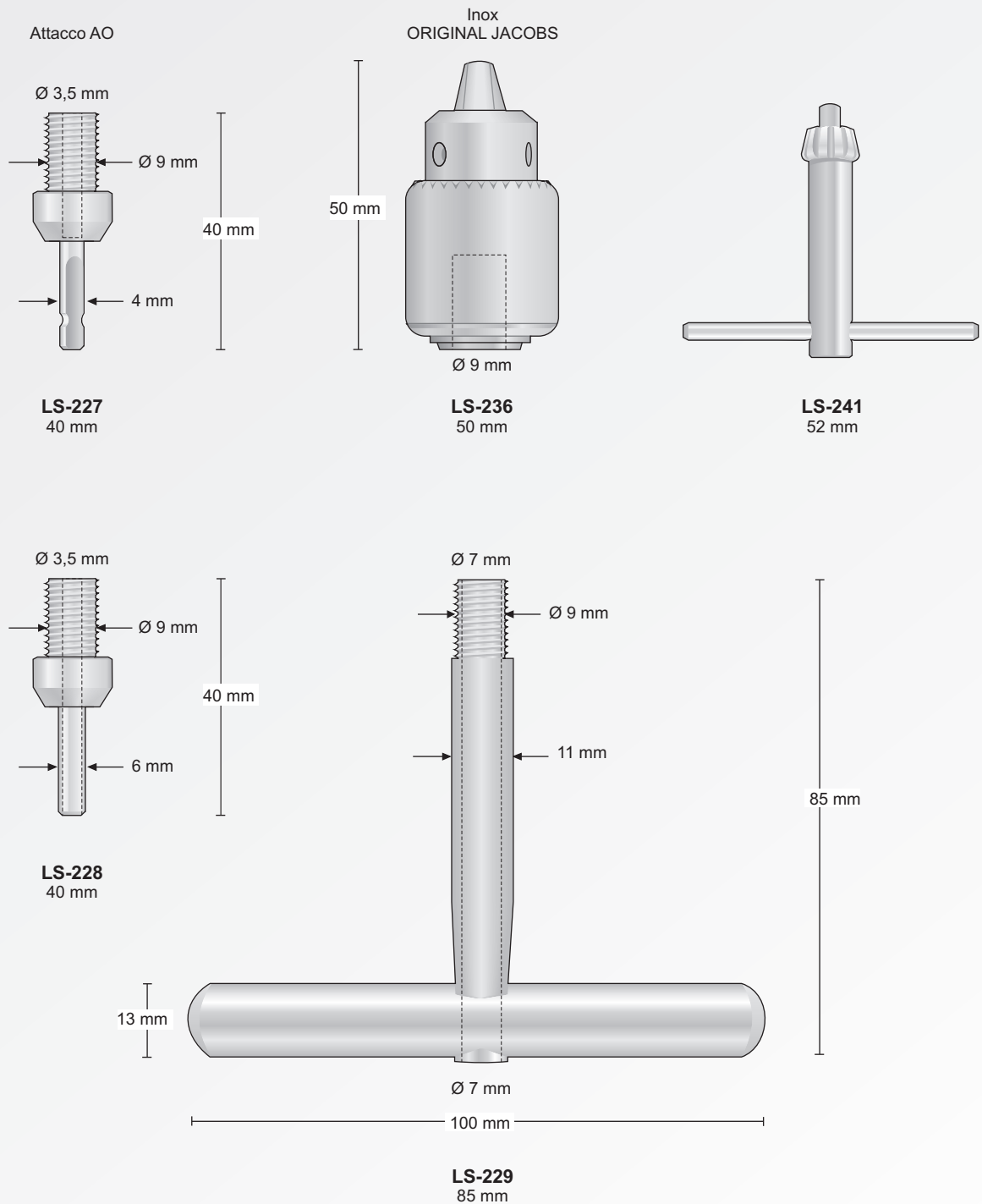

Handbohrfutter

Drilling Chucks

Perforatori a mano con mandrino

Perforadores para huesos

Perforateurs à os

Handbohrapparate

Hand Bone Drills

Trapani a mano per ossa

Perforadores de mano

Perforateurs à main

LS-239
Komplett mit - Complete with
Completo con - Completos con
Completos avec:
1 **LS-236**
1 **LS-237**
1 **LS-238**
1 **LS-241**

Inox
ORIGINAL JACOBS

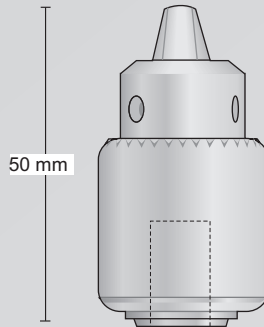

Ø 9 mm

LS-236
50 mm

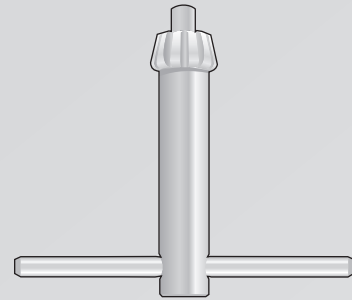

LS-241
52 mm

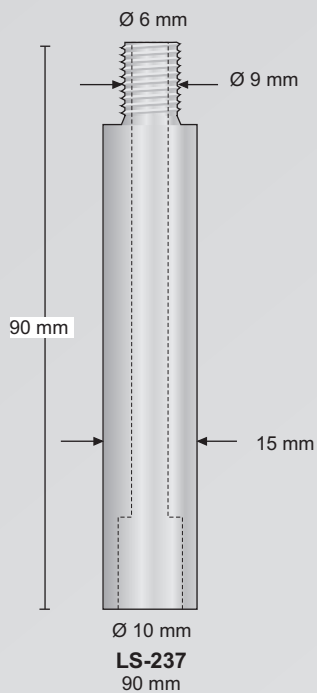

Ø 10 mm
LS-237
90 mm

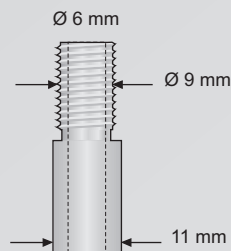

LS-238
130 mm

Handbohrapparate
Hand Bone Drills
Trapani a mano per ossa
Perforadores de mano
Perforateurs à main

Handbohrfutter
Drilling Chucks
Perforatori a mano con mandrino
Perforadores para huesos
Perforateurs à os

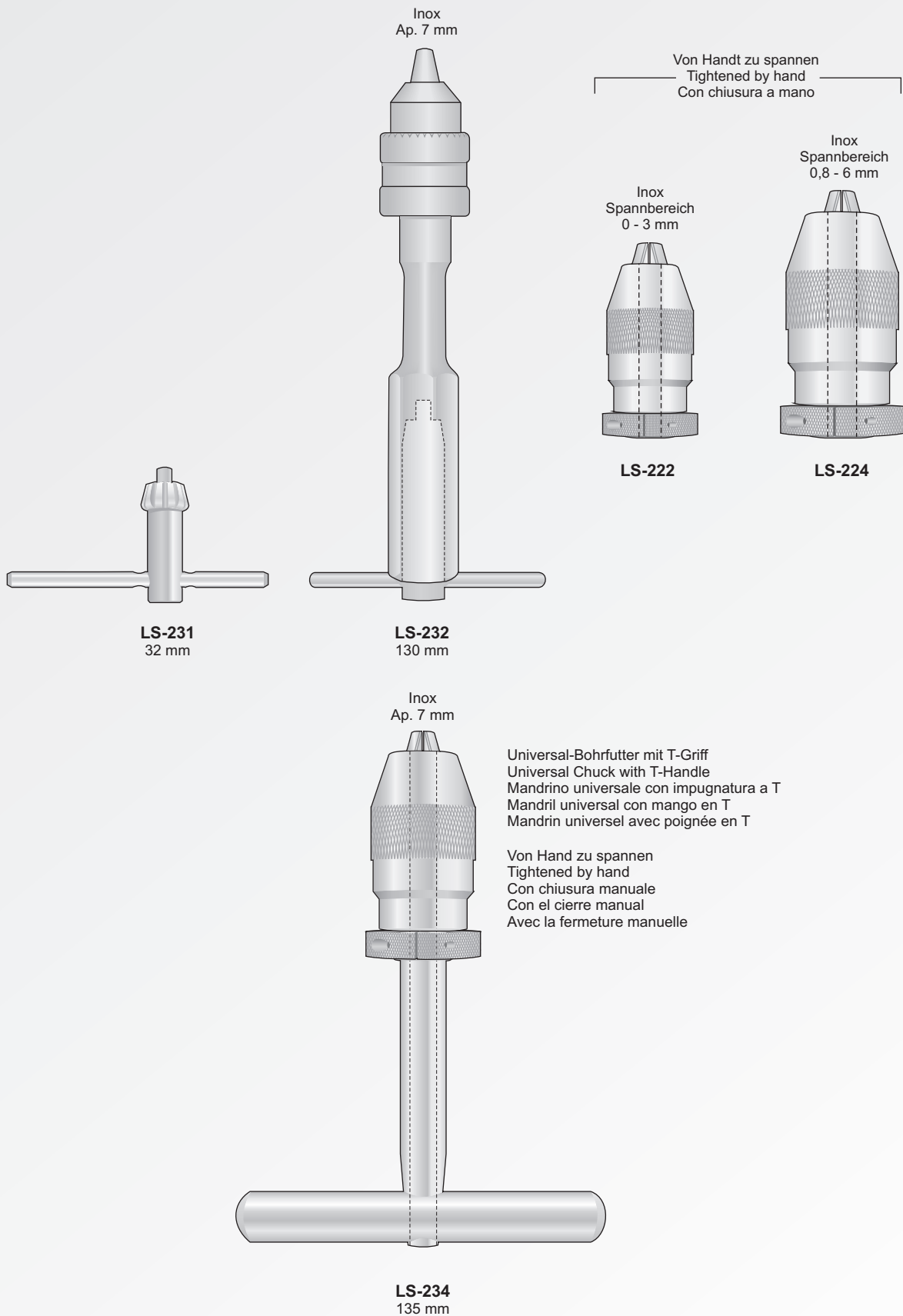

Knochenchirurgie
Bone surgery
Chirurgia ossea
Guia para perforaciòn
Instruments pour Osteosynthese

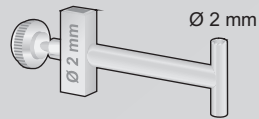

LS-96

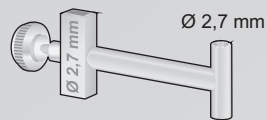

LS-97

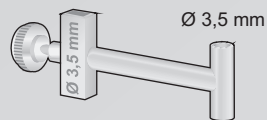

LS-98

Steckbohrbüchsen
Insert-drill
Centrapunte
Manicotto dentato



Ø Außen Ø Für Bohrer
Ø Outside Ø For drills
Ø Esterno Ø Per punte
Ø Exterior Ø Para agujas
Ø Extérieur Ø Pour Mèches

| Cod. Art. | Ø Außen | Ø Für Bohrer |
|-----------|---------|--------------|
| LS-113 | 4,5 mm | 3,2 mm |
| LS-114 | 3,5 mm | 2 mm |
| LS-115 | 3,5 mm | 2,7 mm |

LS-95
Complete with 3 guide
Completo di 3 guide
LS-94+LS-96+LS-97+LS-98

LS-94
Drill guide only
Centratore solo

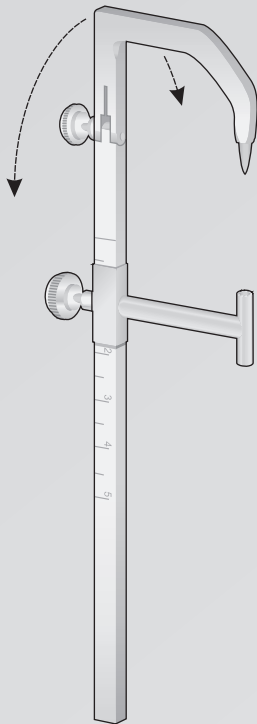

LS-95
145 mm

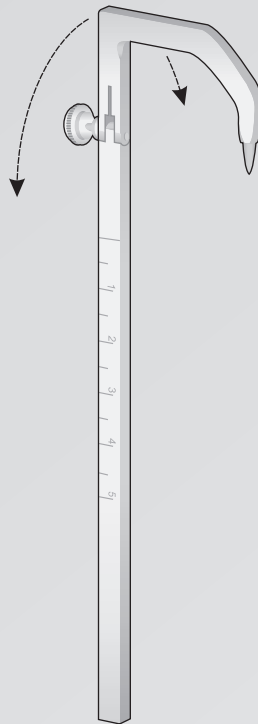

LS-94
145 mm

Gewebeschutzhülsen
Guida per punte elicoidali

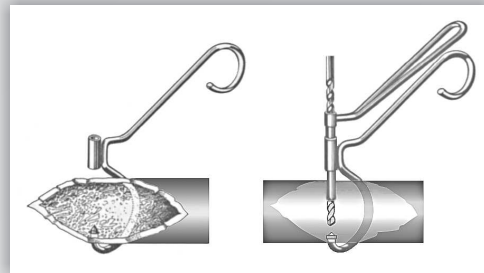

Innen Ø 6,5 mm
Inside Ø 6,5 mm
Interno Ø 6,5 mm
Interior Ø 6,5 mm
Intérieur Ø 6,5 mm

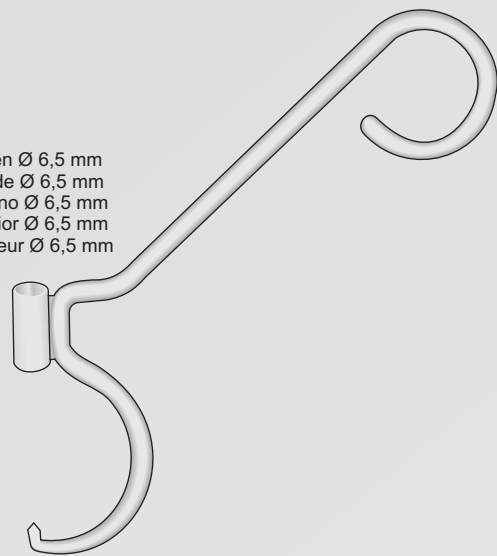

LS-112

Bohrbüchsen zu Knochenplatten - Drill guides - Centrori guida punte - Guide méche

Codificazione del colore
verde = centrico
oro = eccentrico

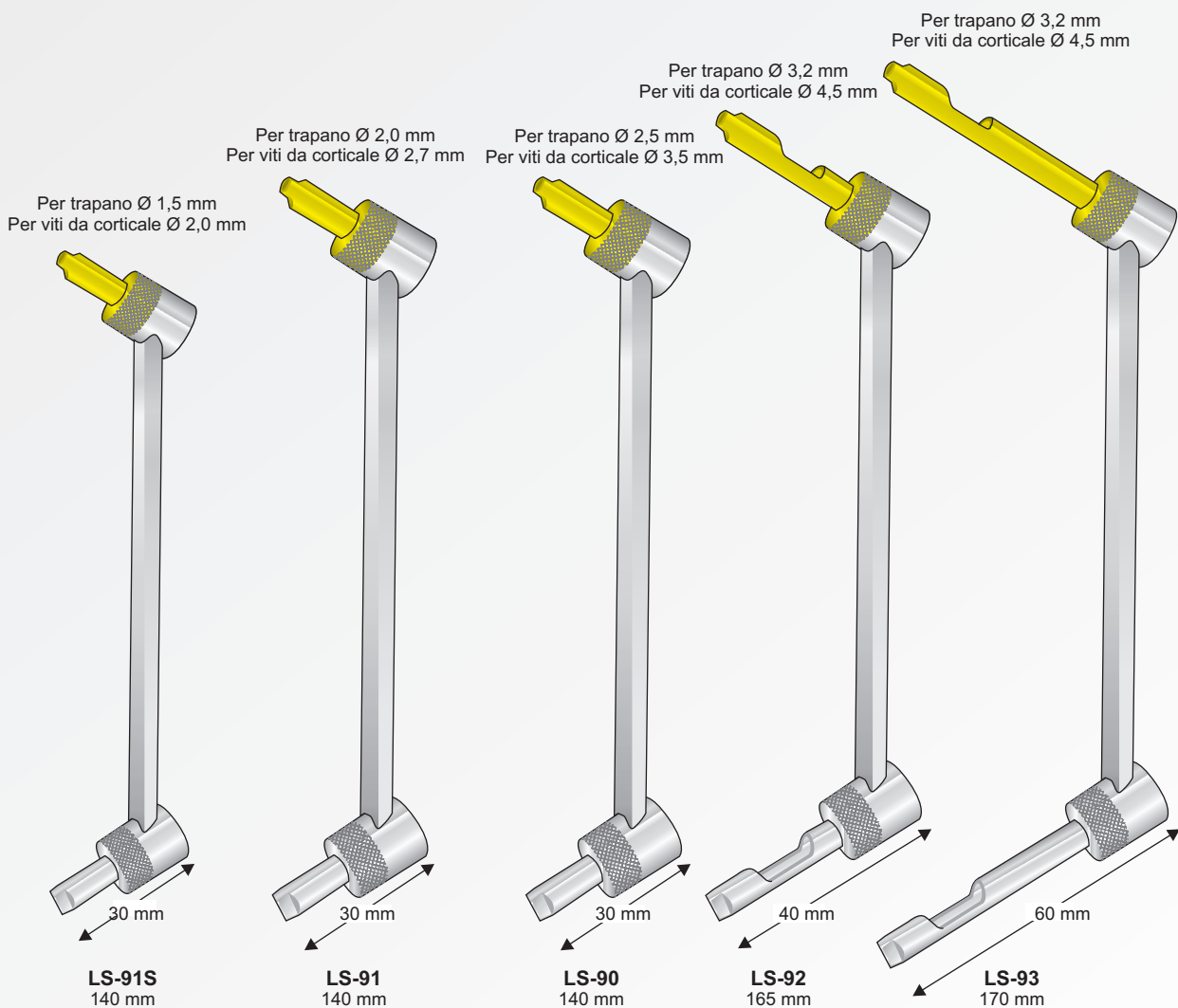

Osteosynthese Schränkeisen
Osteosynthesis Instruments
Strumenti per osteosintesi
Instrumentos para Osteosintesis
Instruments pour Ostéosynthèse

Bohrbüchsen zu Knochenplatten - Drill guides - Centrori guida punte - Guide méche

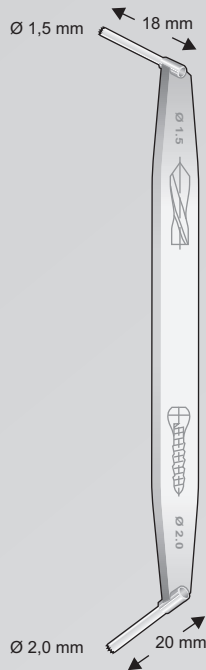

LS-73
120 mm

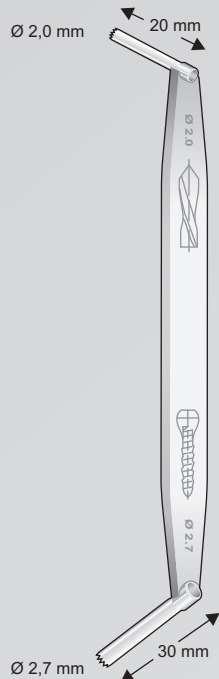

LS-74
120 mm



LS-75
120 mm

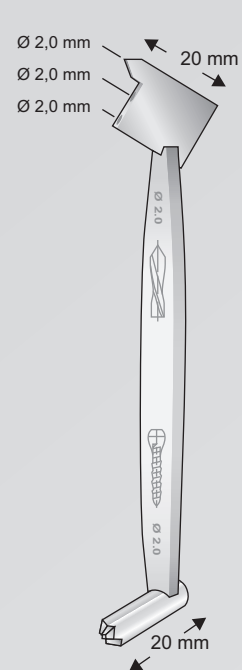

LS-80
110 mm

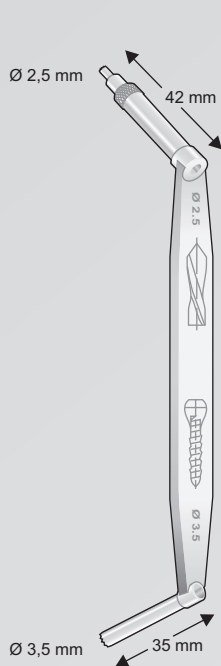

LS-81

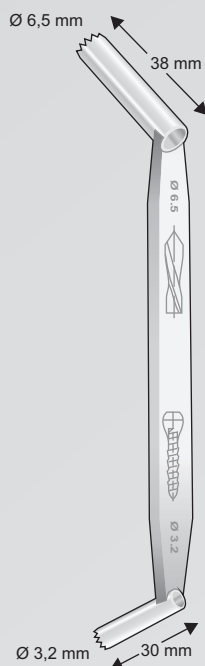

LS-82

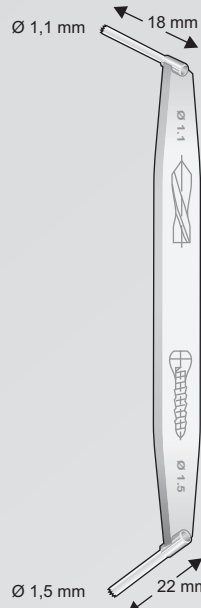

LS-83
105 mm

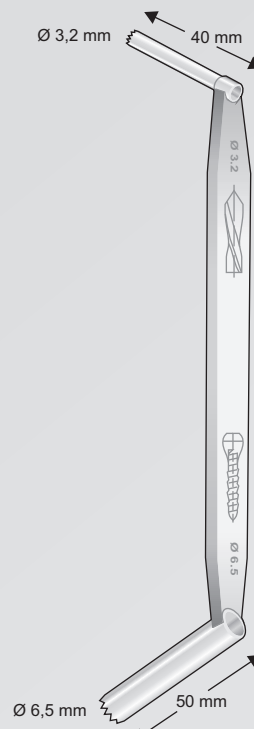

LS-84
160 mm

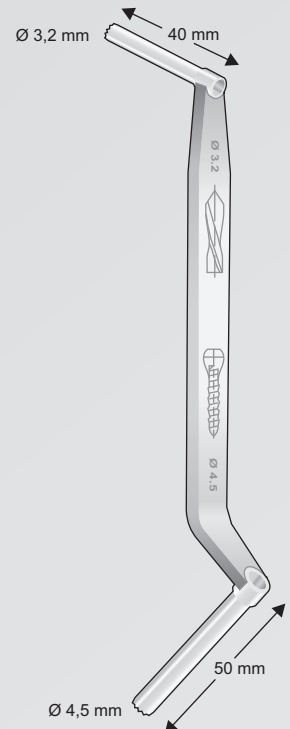

LS-85

Bohrbüchsen zu Knochenplatten - Drill guides - Centratori guida punte - Guide méche

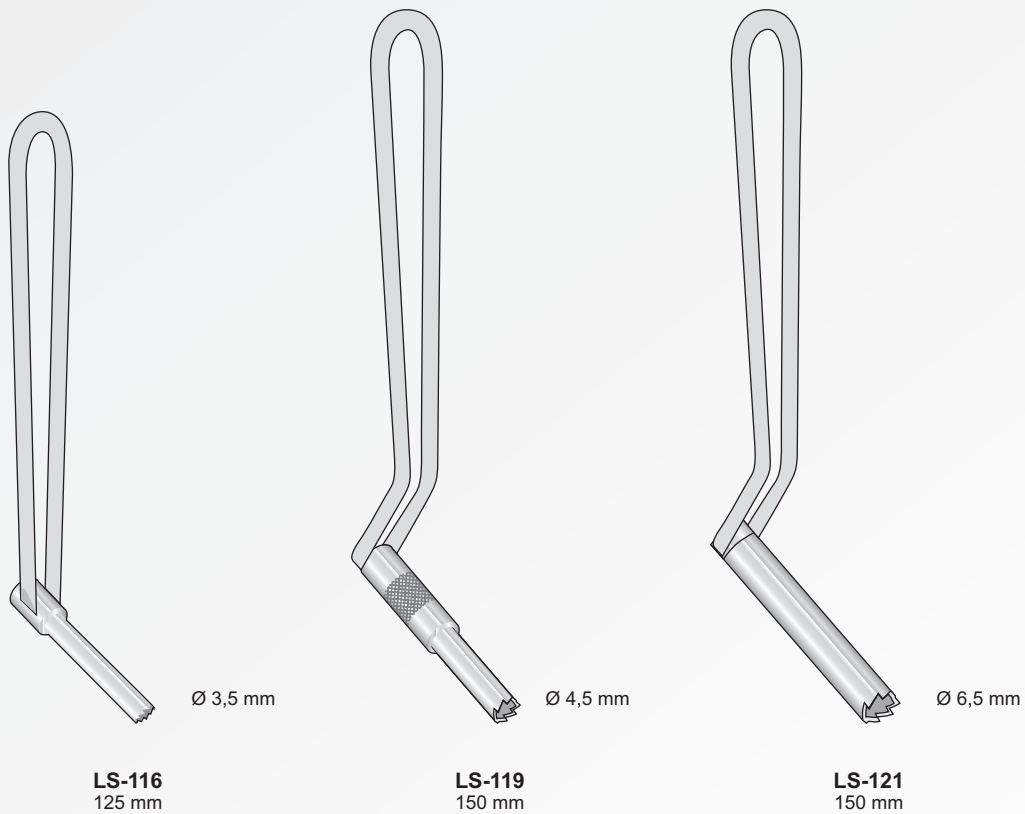
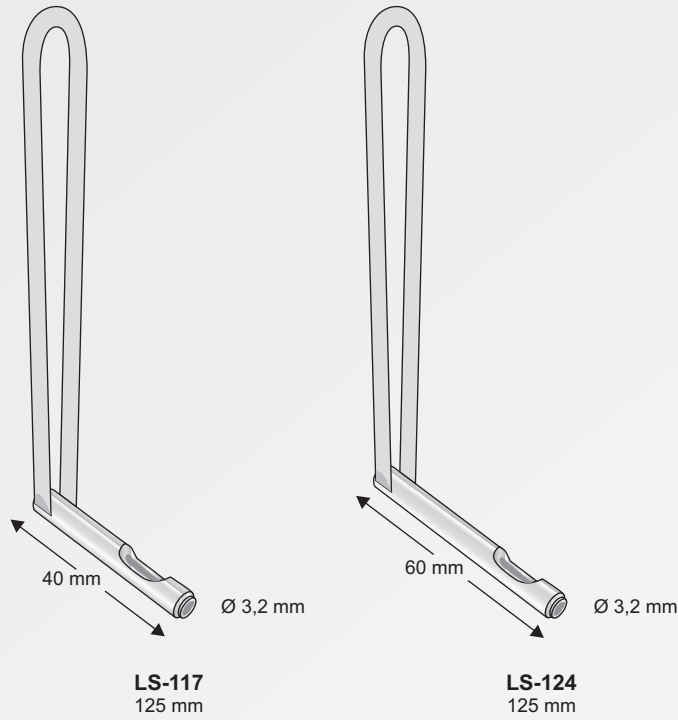

Knochenchirurgie
Bone surgery
Chirurgia ossea
Guia para perforaciòn
Instruments pour Osteosynthese

Handgriffe mit schnellspann futter
Handles with quick-action chuck
Manico con mandrino rapido
Poignées avec mandrins rapides

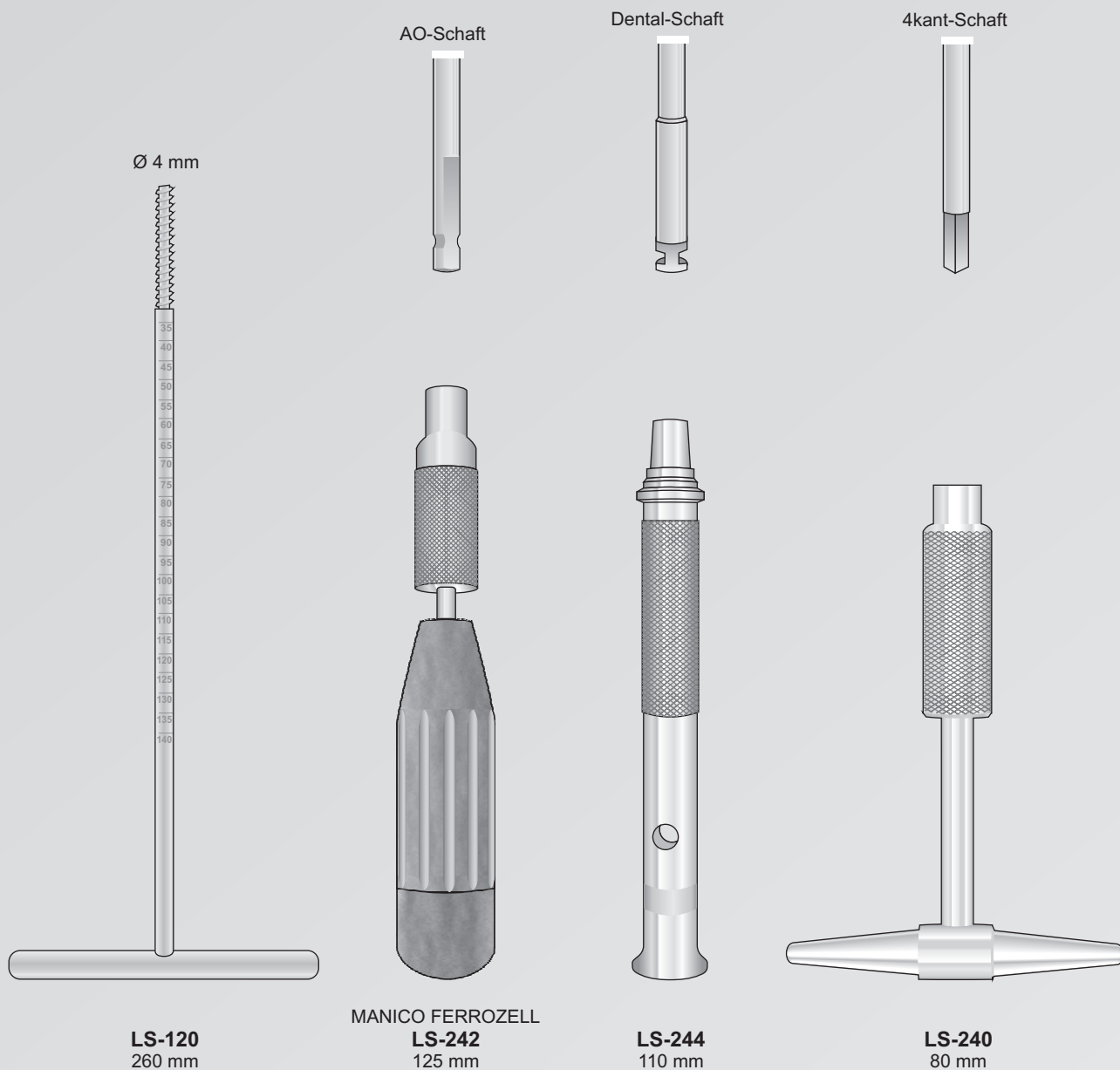

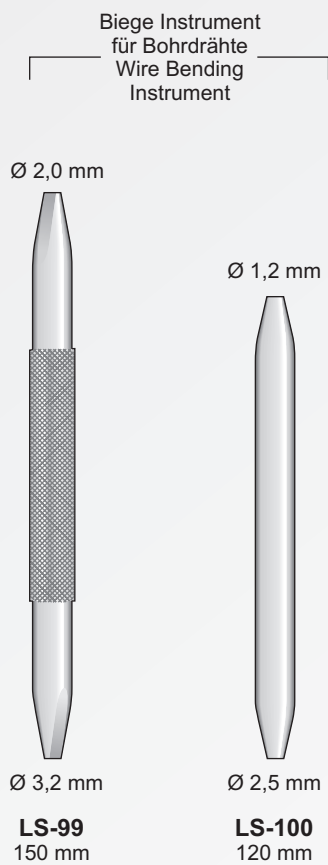

Fino a Ø 3 mm
Bis Ø 3 mm
Up to Ø 3 mm

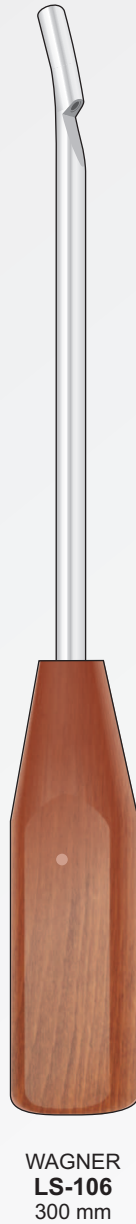

Extraktionshaken
Extraction hooks
Gancio d'estrazione
Ganchos extractores
Crochets d'extraction

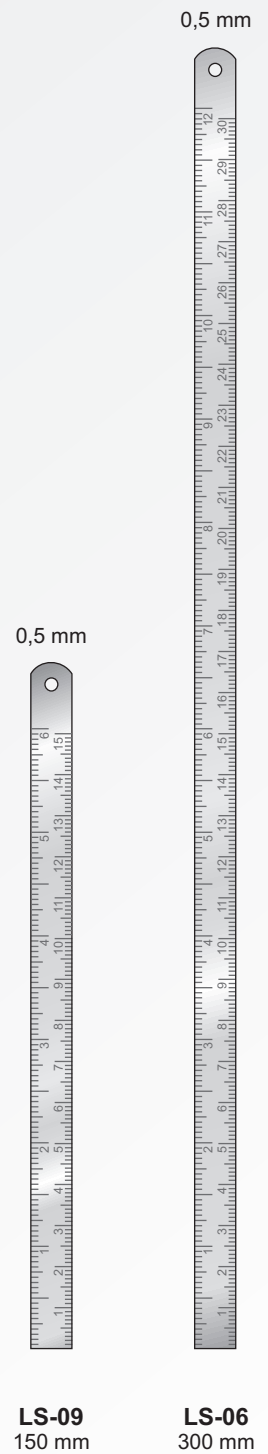

Meßinstrumente
Measuring instruments
Strumenti per misura
Instrumentos para medir
Instruments à mesurer

Messgerät zur Bestimmung die Schraubenlänge
Screw depth gauges, to select proper length of screw
Misuratore per determinare la lunghezza delle viti
Metro de longitud de los tornillos
Instruments de mesure pour determiner la longueur de vis

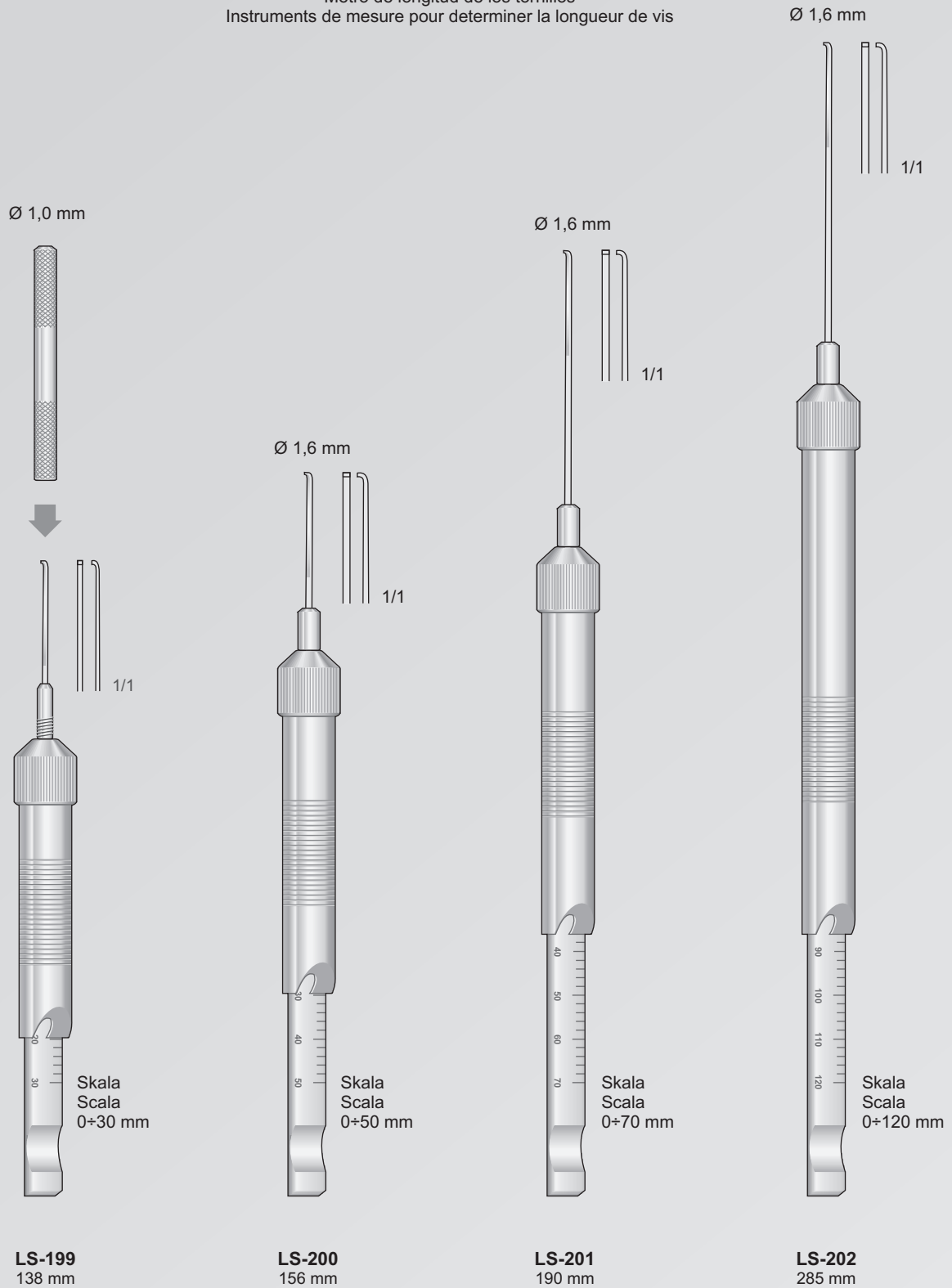

Schraubendreher
Screw drivers
Cacciaviti
Destornilladores
Tourne-vis

Schraubenzieher mit Ferrozellgriff
Screws driver with Ferrozell handle
Giraviti con manico di Ferrozell
estornilladores con mango de Ferrozell
DJeux de tournevis avec poignée en Ferrozell

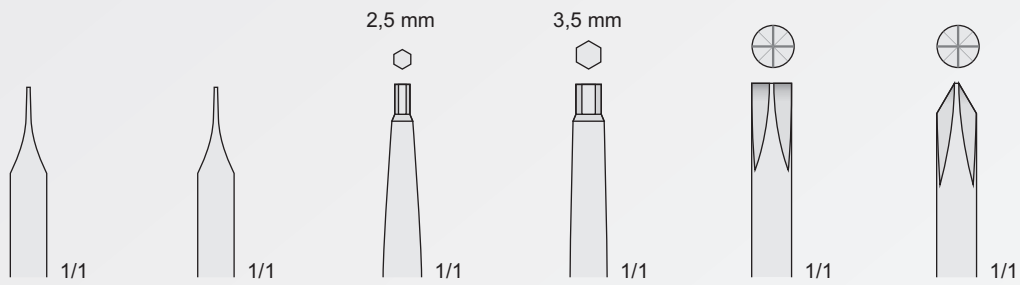

LS-310
170 mm

LANE
LS-311
250 mm

LS-312
250 mm

LS-313
250 mm

LS-314
250 mm

PHILIPS
LS-315
250 mm

Orthopädie - Osteosynthese
 Bone Surgery - Osteosynthesis
 Ortopedia - Osteosintesi
 Chirurgia òsea - Osteosintesis
 Orthopédie - Ostéosynthèse

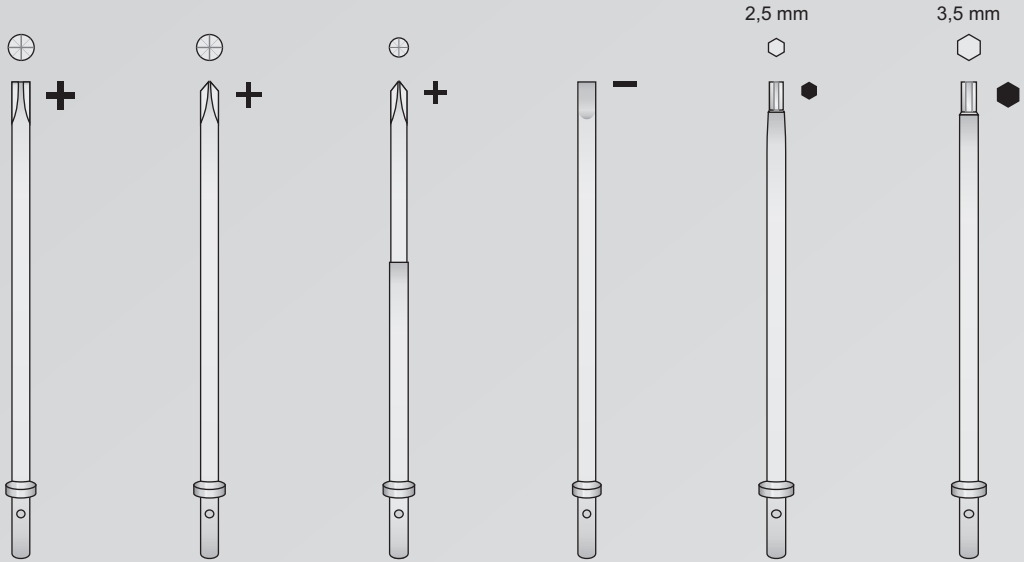

LS-321 140 mm **LS-322** 140 mm **LS-323** 140 mm **LS-324** 140 mm **LS-325** 140 mm **LS-326** 140 mm

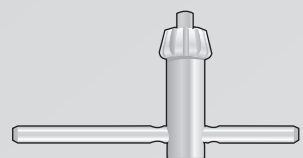

LS-231
32 mm

LS-330
 Schraubenzieher, Set mit Etui - Komplett
 Box with screws driver - Complete
 Scatola con set giraviti - Completo
 Set destornilladores - Completos
 Jeu de tournevis, en boite - Complete



LS-320
145 mm

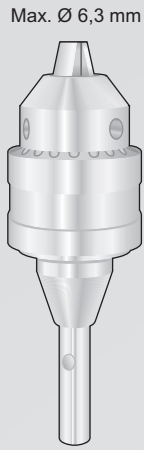

UNIVERSAL
LS-235
75 mm

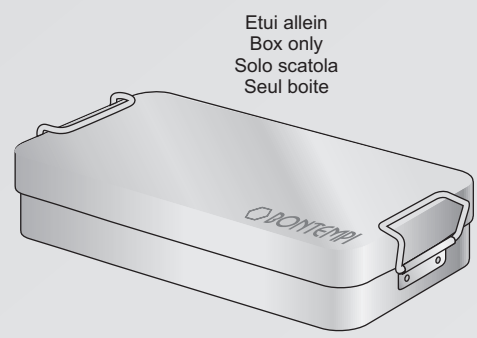

LS-329
200x100x40 mm

Etui allein
 Box only
 Solo scatola
 Seul boite

Schraubenzieher mit Ferrozellgriff
Screws driver with Ferrozell handle
Giraviti con manico di Ferrozell
estornilladores con mango de Ferrozell
DJeux de tournevis avec poignée en Ferrozell

1,5 mm



LS-127
35 mm

2,5 mm

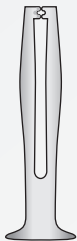

LS-128
50 mm

+ 1,5 -2,5 mm

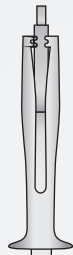

LS-316
195 mm

○ 1,5 mm

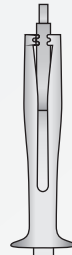

LS-317
195 mm

○ 2,5 mm

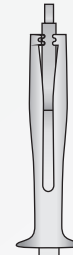

LS-318
195 mm

Nadelhalter
Needle holders
Port'aghi per fili metallici
Portaagujas para hilos
Porte aiguilles pour fil métallique

Drahtspannzangen mit Hartmetalleinlagen
Wire twisting Forceps with Tungsten Carbide inserts
Pinze per filo con morsi in Carburo di Tungsteno
Pinzas cierra-hilos con bocas de Carburo Tungsteno
Pincas serre-fils avec mors en Tungstène

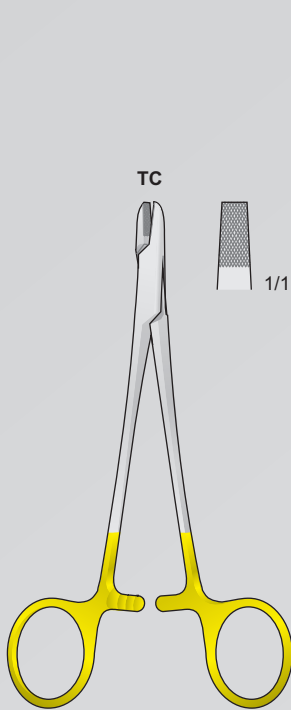

PH-58
150 mm

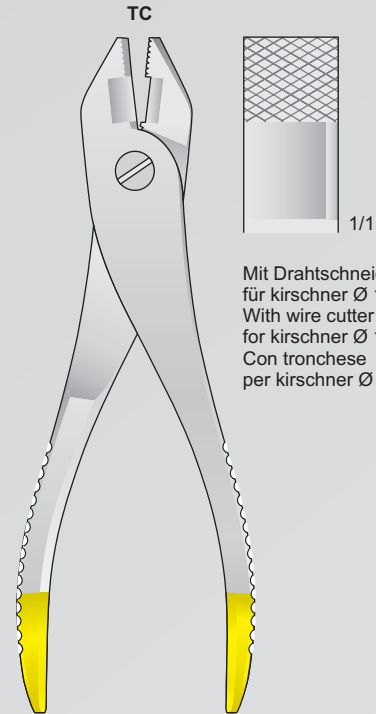

LX-125
220 mm

Mit Drahtschneider
für kirschner Ø 1,5 mm
With wire cutter
for kirschner Ø 1,5 mm
Con tronchese
per kirschner Ø 1,5 mm

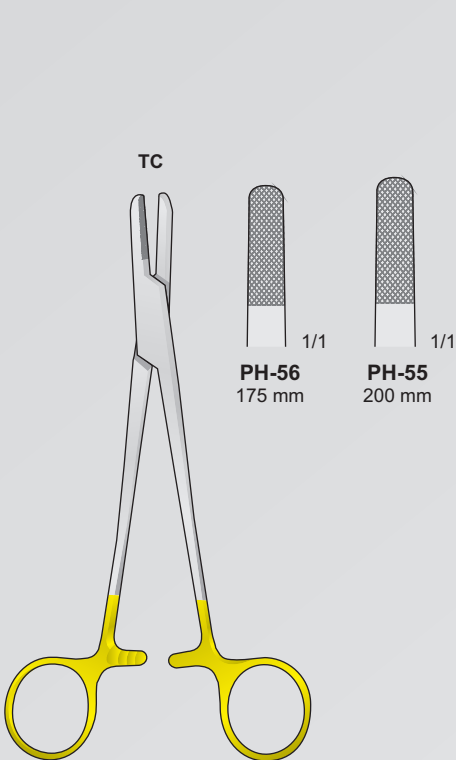

PH-55/PH-56

PH-56
175 mm

PH-55
200 mm

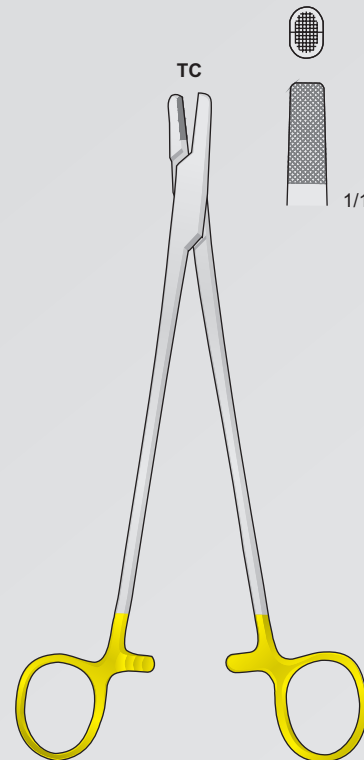

BAUMGARTNER
PH-57
200 mm

Extraktionszangen für bohrdrähte
Extraction pliers for boring wires
Pinze per estrazione fili metallici
Pinzas para extracción de hilo metálico
Pinces pour l'extraction des broches

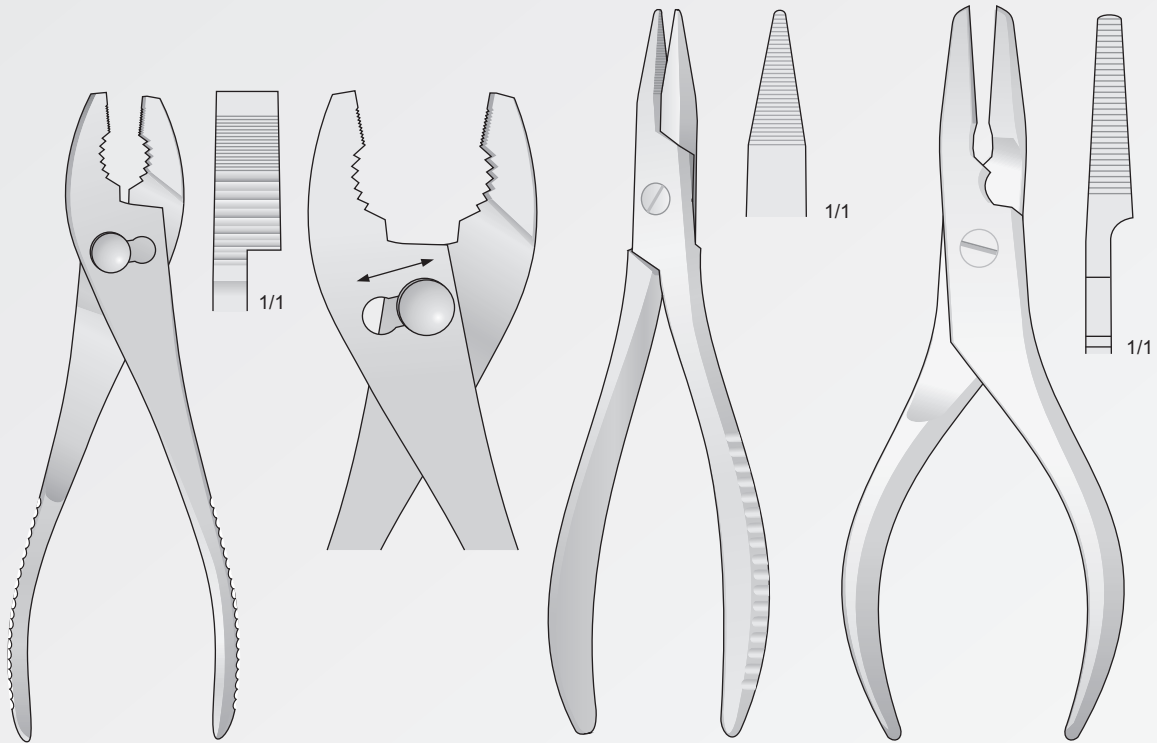

VH-40
200 mm

VH-23
190 mm

LX-134
160 mm

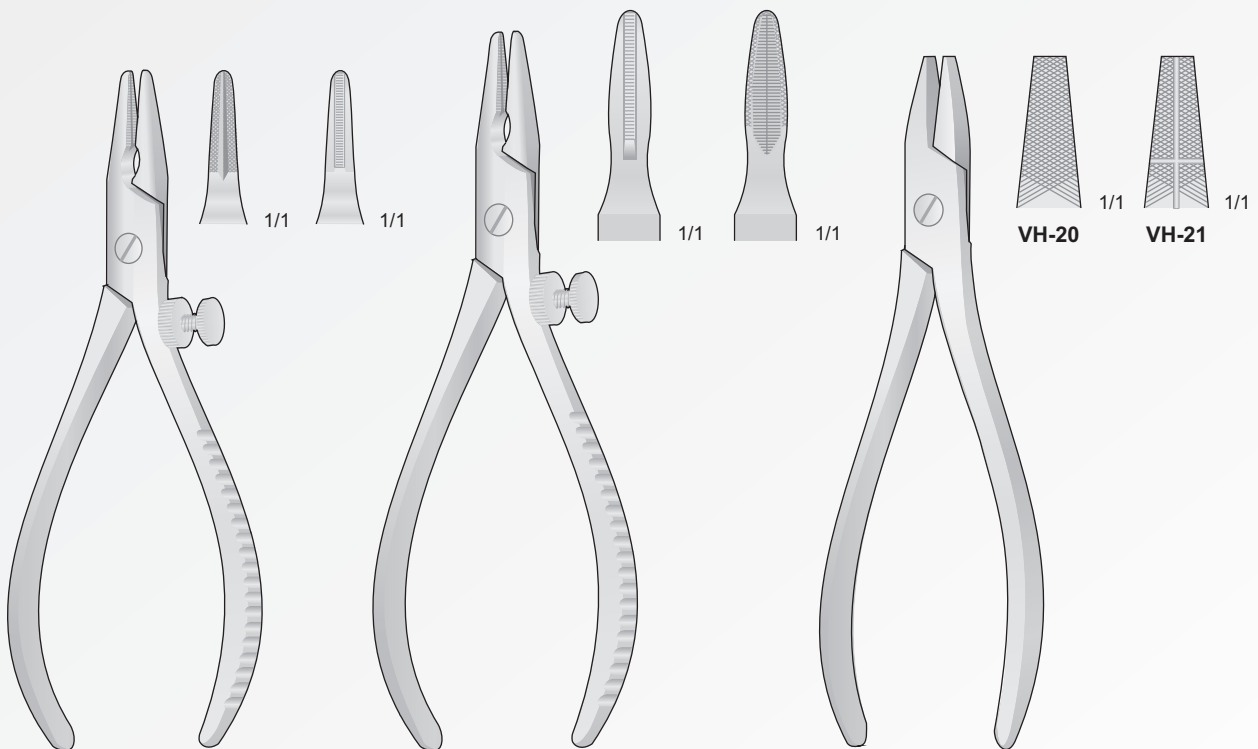

LX-130
140 mm

LX-131
180 mm

VH-20/VH-21
175 mm

Drahtschneidezangen
Wire cutting pliers
Tronchesi per fili metallici
Alicates para cortar alambre
Pincers à couper le fil

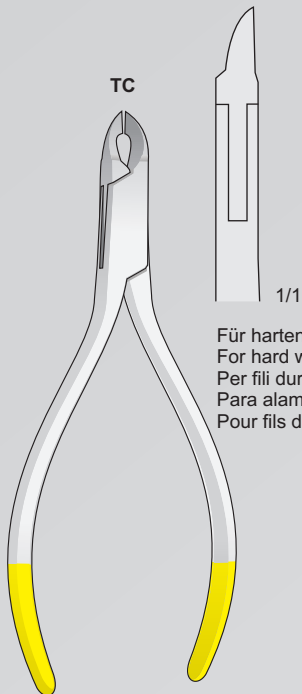

ANGLE
LX-95TC
130 mm

Für harten Draht bis \varnothing 0,4 mm
For hard wire with \varnothing 0,4 mm
Per fili duri di \varnothing 0,4 mm
Para alambres duros de \varnothing 0,4 mm
Pour fils durs avec \varnothing 0,4 mm

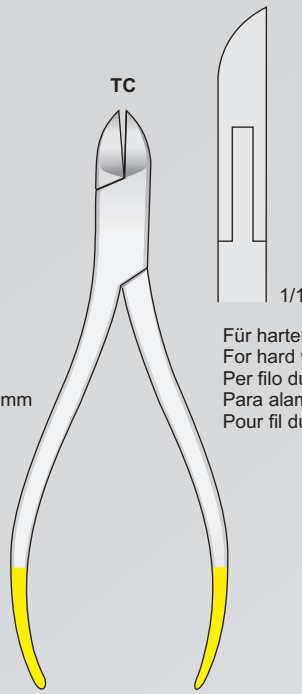

LX-99
130 mm

Für harten Draht bis \varnothing 1 mm
For hard wire with \varnothing 1 mm
Per filo duro \varnothing 1 mm
Para alambres duro \varnothing 1 mm
Pour fil dur avec \varnothing 1 mm

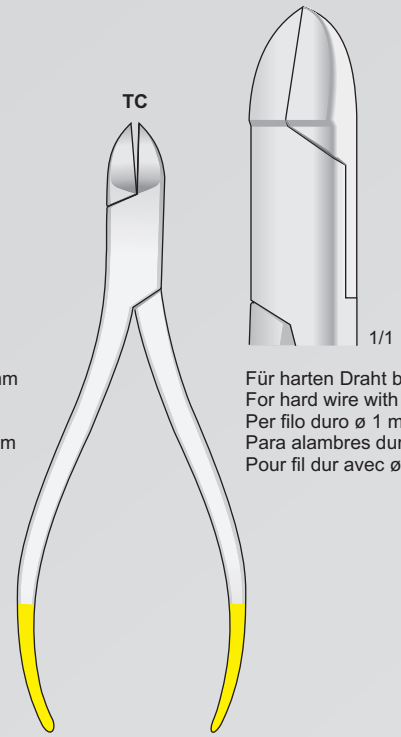

LX-96TC
150 mm

Für harten Draht bis \varnothing 1 mm
For hard wire with \varnothing 1 mm
Per filo duro \varnothing 1 mm
Para alambres duro \varnothing 1 mm
Pour fil dur avec \varnothing 1 mm

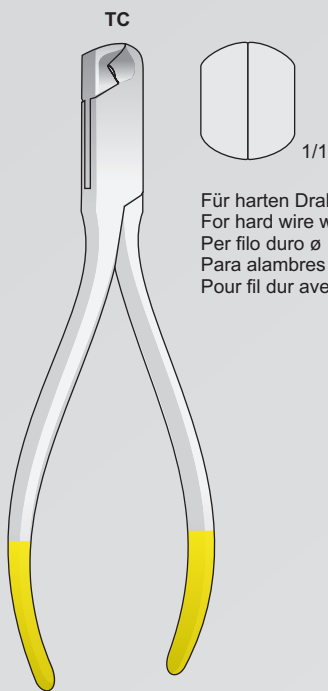

LX-92TC
145 mm

Für harten Draht bis \varnothing 1 mm
For hard wire with \varnothing 1 mm
Per filo duro \varnothing 1 mm
Para alambres duro \varnothing 1 mm
Pour fil dur avec \varnothing 1 mm



LX-82
185 mm

Für harten Draht bis \varnothing 1,7 mm
For hard wire with \varnothing 1,7 mm
Per filo duro \varnothing 1,7 mm
Para alambres duro \varnothing 1,7 mm
Pour fil dur avec \varnothing 1,7 mm

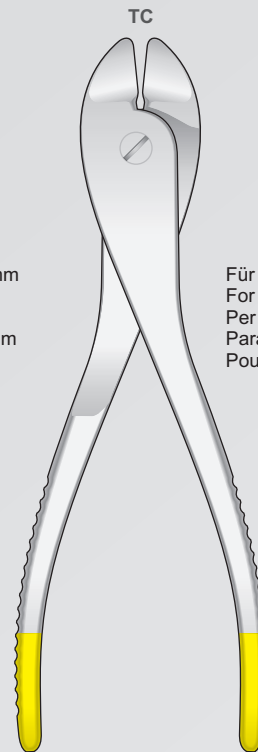

LX-101
185 mm

Für harten Draht bis \varnothing 1,7 mm
For hard wire with \varnothing 1,7 mm
Per filo duro \varnothing 1,7 mm
Para alambres duro \varnothing 1,7 mm
Pour fil dur avec \varnothing 1,7 mm

Drahtschneidezangen
Wire cutting pliers
Tronchesi per fili metallici
Alicates para cortar alambre
Pinces à couper le fil

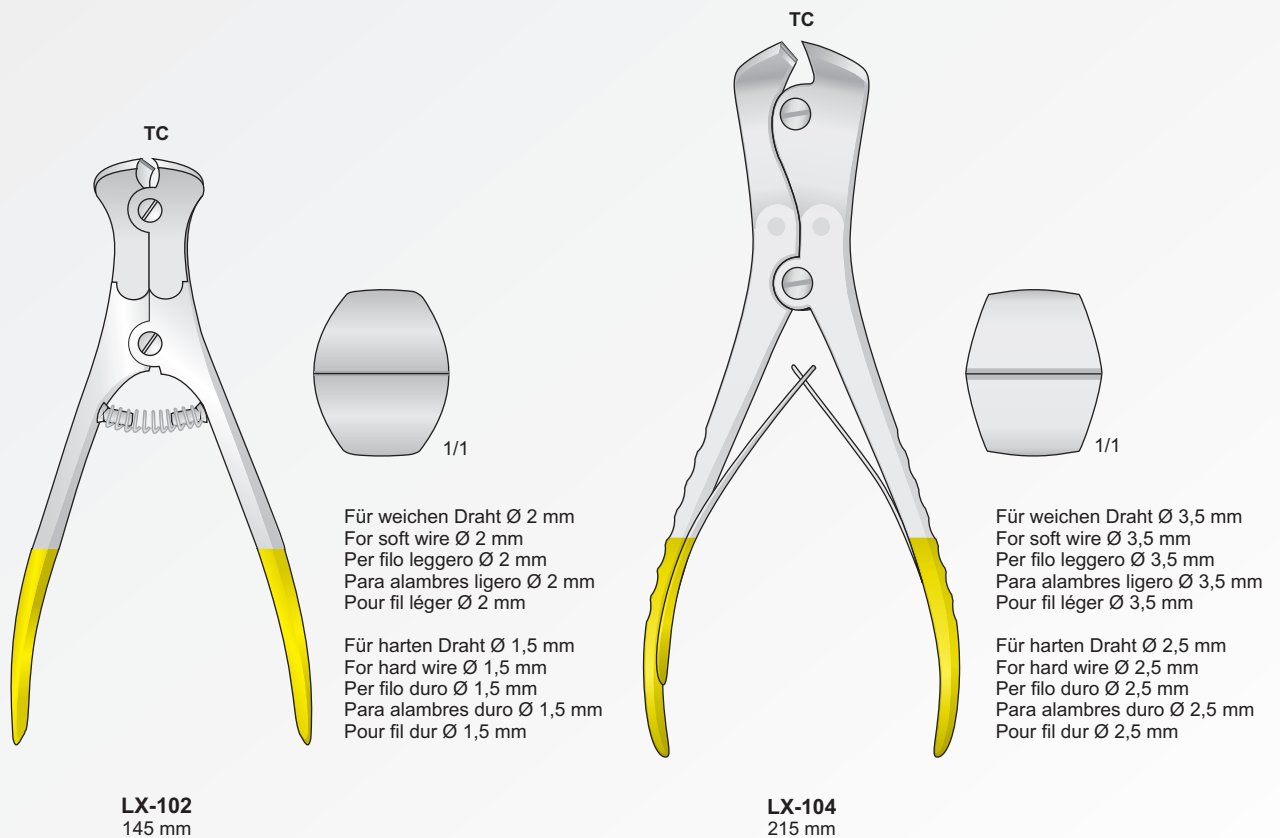

Drahtschneidezangen
Wire cutting pliers
Tronchesi per fili metallici
Alicates para cortar alambre
Pinces à couper le fil

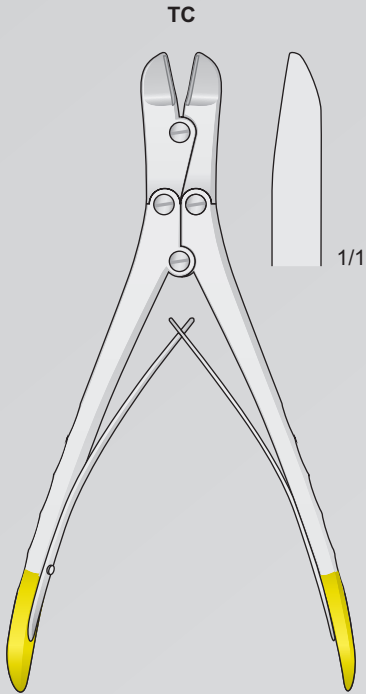

Für weichen Draht Ø 2 mm
For soft wire Ø 2 mm
Per filo leggero Ø 2 mm
Para alambres ligero Ø 2 mm
Pour fil léger Ø 2 mm

Für harten Draht Ø 1,6 mm
For hard wire Ø 1,6 mm
Per filo duro Ø 1,6 mm
Para alambres duro Ø 1,6 mm
Pour fil dur Ø 1,6 mm

LX-103
170 mm

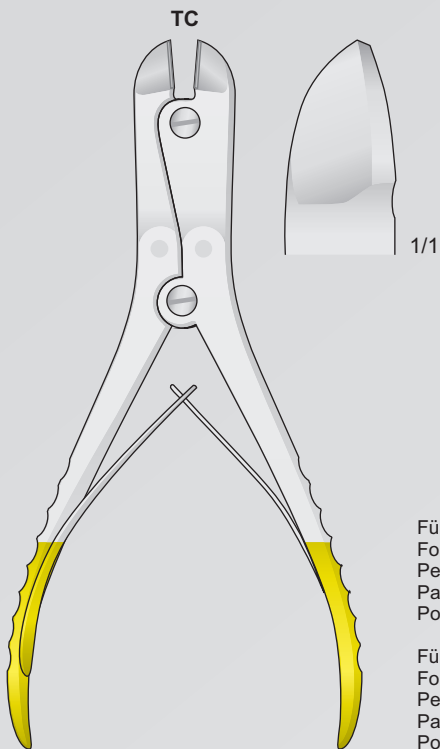

Für weichen Draht Ø 3 mm
For soft wire Ø 3 mm
Per filo leggero Ø 3 mm
Para alambres ligero Ø 3 mm
Pour fil léger Ø 3 mm

Für harten Draht Ø 2,2 mm
For hard wire Ø 2,2 mm
Per filo duro Ø 2,2 mm
Para alambres duro Ø 2,2 mm
Pour fil dur Ø 2,2 mm

LX-106
230 mm

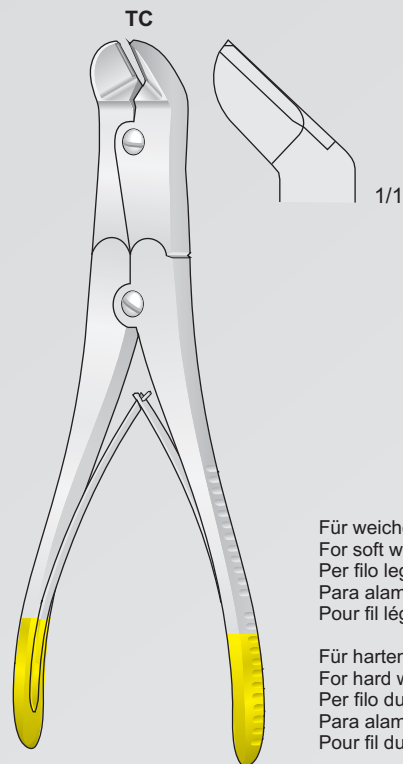

Für weichen Draht Ø 2,5 mm
For soft wire Ø 2,5 mm
Per filo leggero Ø 2,5 mm
Para alambres ligero Ø 2,5 mm
Pour fil léger Ø 2,5 mm

Für harten Draht Ø 2 mm
For hard wire Ø 2 mm
Per filo duro Ø 2 mm
Para alambres duro Ø 2 mm
Pour fil dur Ø 2 mm

LX-105
230 mm

Drahtschneidezangen
Wire cutting pliers
Tronchesi per fili metallici
Alicates para cortar alambre
Pincas à couper le fil

Für weichen Draht Ø 7 mm
For soft wire Ø 7 mm
Per filo leggero Ø 7 mm
Para alambres ligero Ø 7 mm
Pour fil léger Ø 7 mm

Für harten Draht Ø 6 mm
For hard wire Ø 6 mm
Per filo duro Ø 6 mm
Para alambres duro Ø 6 mm
Pour fil dur Ø 6 mm

Für weichen Draht Ø 7 mm
For soft wire Ø 7 mm
Per filo leggero Ø 7 mm
Para alambres ligero Ø 7 mm
Pour fil léger Ø 7 mm

Für harten Draht Ø 6 mm
For hard wire Ø 6 mm
Per filo duro Ø 6 mm
Para alambres duro Ø 6 mm
Pour fil dur Ø 6 mm

Für weichen Draht Ø 5 mm
For soft wire Ø 5 mm
Per filo leggero Ø 5 mm
Para alambres ligero Ø 5 mm
Pour fil léger Ø 5 mm

Für harten Draht Ø 4,5 mm
For hard wire Ø 4,5 mm
Per filo duro Ø 4,5 mm
Para alambres duro Ø 4,5 mm
Pour fil dur Ø 4,5 mm

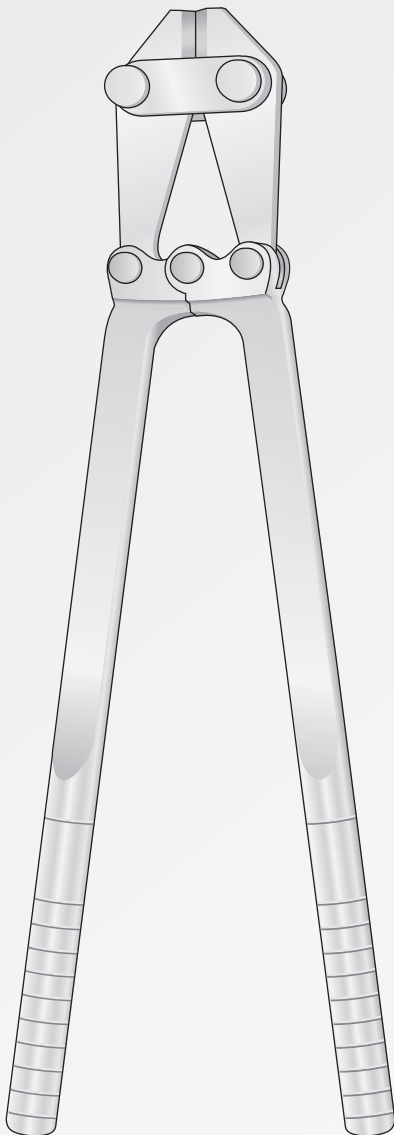

VF-98
480 mm

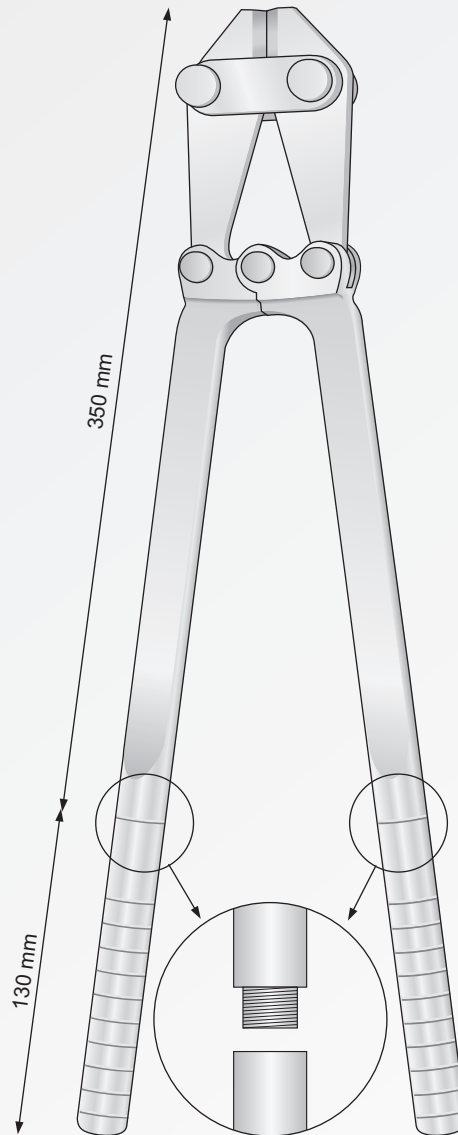

VF-98M
480 mm

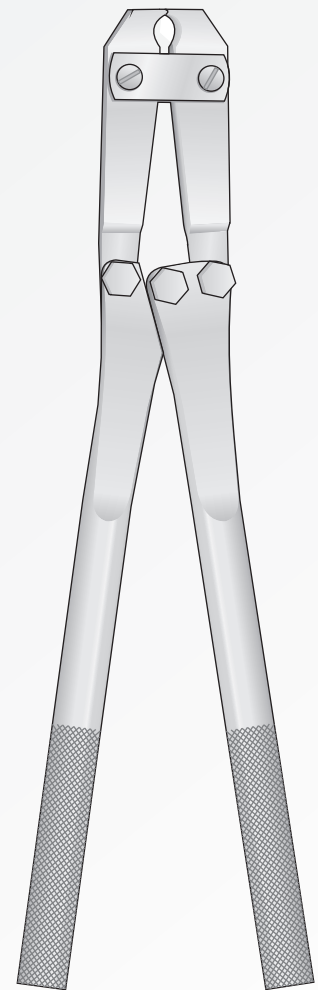

LX-107
375 mm

Extraktionszangen für bohrdrähte
Extraction pliers for boring wires
Pinze per estrazione fili metallici
Pinzas para extracción de hilo metálico
Pincas pour l'extraction des broches

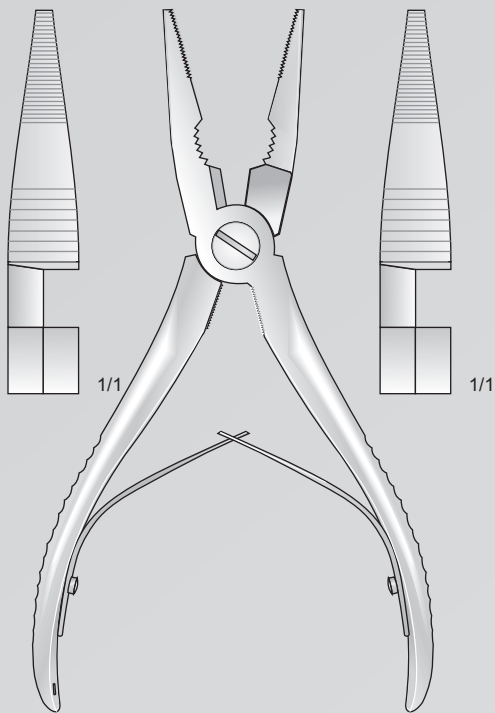

LX-135
175 mm

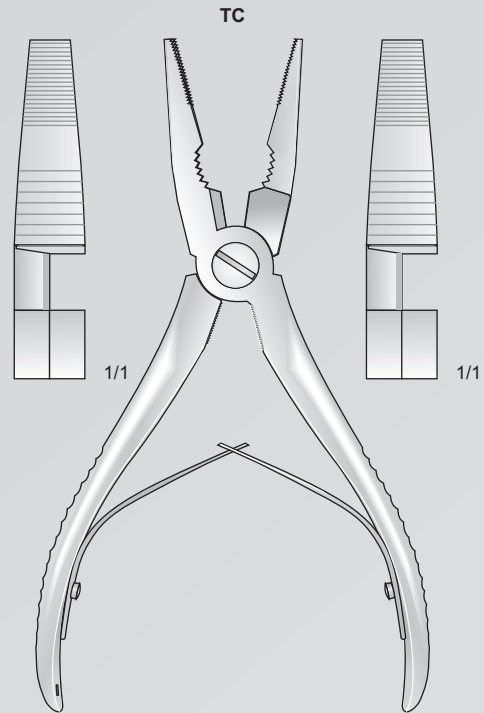

LX-136
165 mm

Parallel-Flachzange - Flat-nosed pliers, parallel
Pinza a branche parallele - Alicates planos - Pincas plates

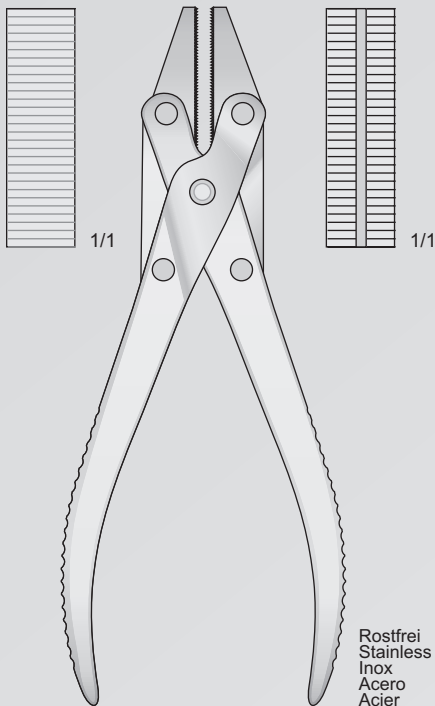

VH-25
185 mm

Rostfrei
Stainless Steel
Inox
Acero
Acier

Parallel-Flachzange mit Seitenschneider
Flat-nose pliers parallel with lateral wire cutter
Pinza a branche parallele con tronchese

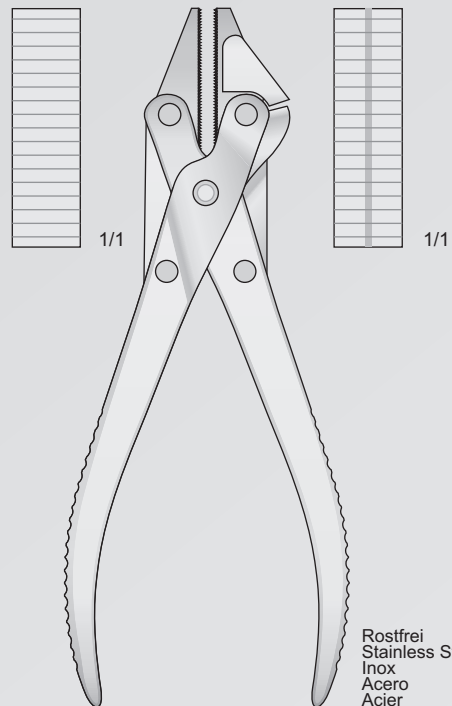

LX-80
185 mm

Rostfrei
Stainless Steel
Inox
Acero
Acier

Extraktionszangen für bohrdrähte
Extraction pliers for boring wires
Pinze per estrazione fili metallici
Pinzas para extracción de hilo metálico
Pincas pour l'extraction des broches

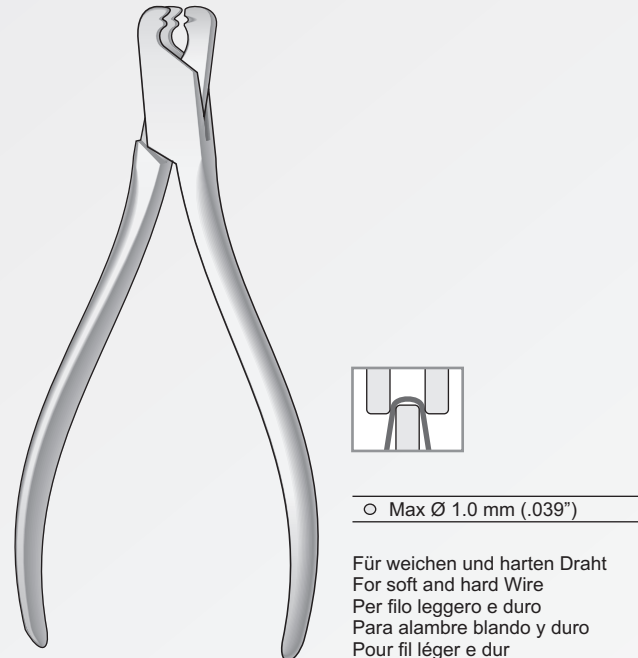
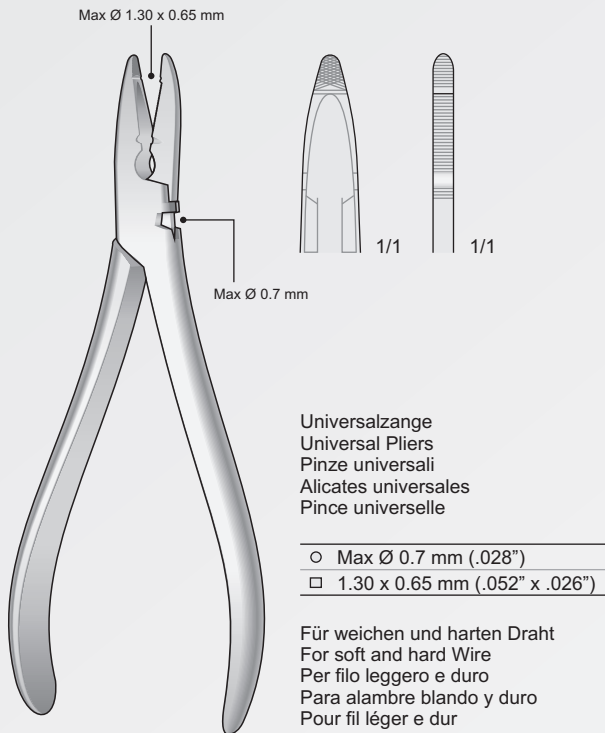

WALDSACHS
DP-84
150 mm

ADERER
DP-41
145 mm

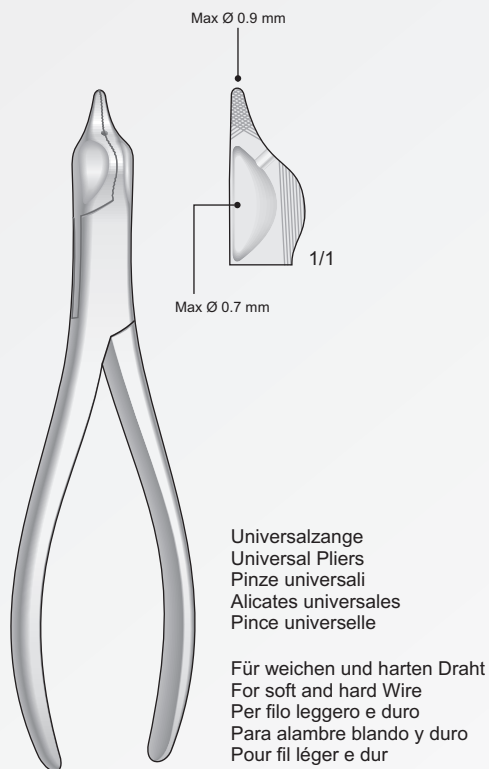

DP-71
150 mm

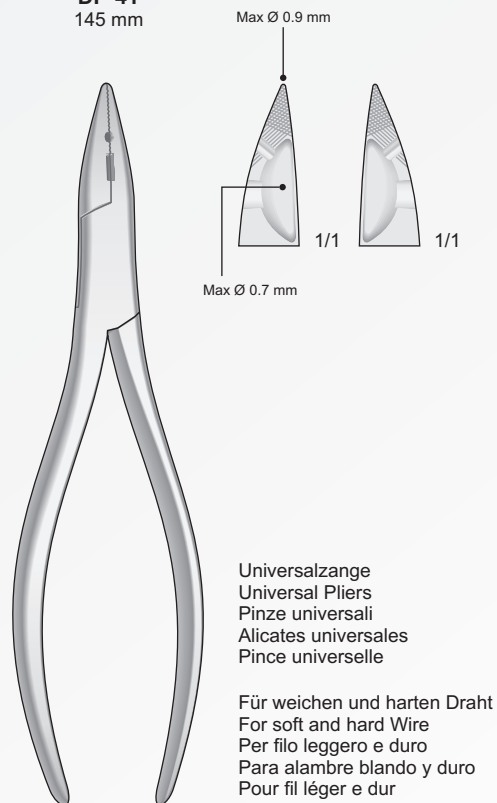

DP-75
160 mm

Draht und Blehscheren
Wire and plate cutting scissors
Forbici per fili metallici
Tijeras para cortar alambre
Ciseaux coupe-fils métalliques

Draht-und Blehschere gezahnt
Wire cutting scissor serrated
Forbice universale dentellata
Tijeras para cortar hilo de acero dentadas
Ciseaux à couper les fils métalliques

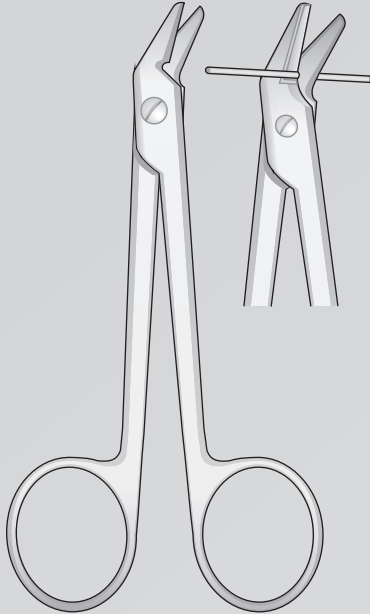

DP-90
120 mm

Smusse
Blunt
Stumpf
Mousses
Romas

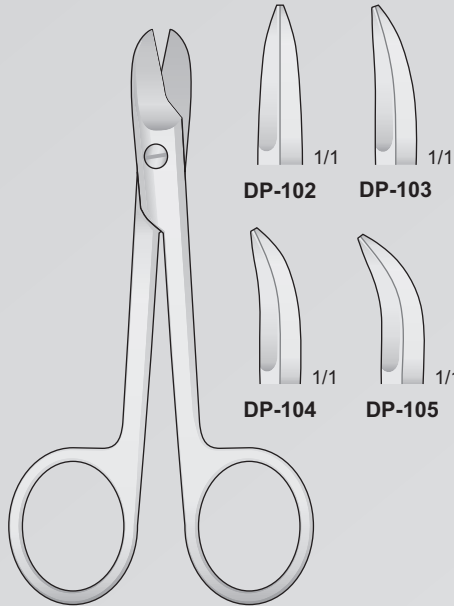

BEEBE
DP-102/DP-105
110 mm

Acute
Sharp
Spitz
Pointus
Agudas

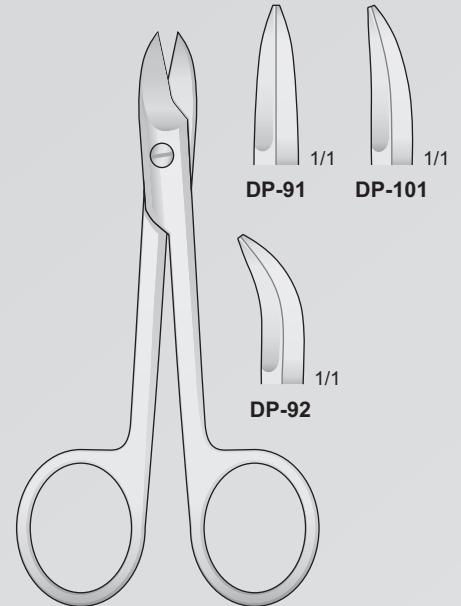

BEEBE
DP-91/DP-101
110 mm

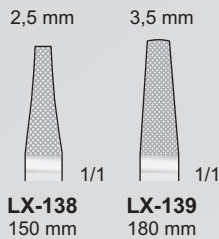

LX-138
150 mm

LX-139
180 mm

Flachzange, Extraktionszange
für Bohrdrähte
Flat pliers, Extraction
pliers for wires
Pinze per estrazione fili
Alicates para extracción,
Alicates para sacar alambre
Pince plate, Pincers pour
extraction des broches

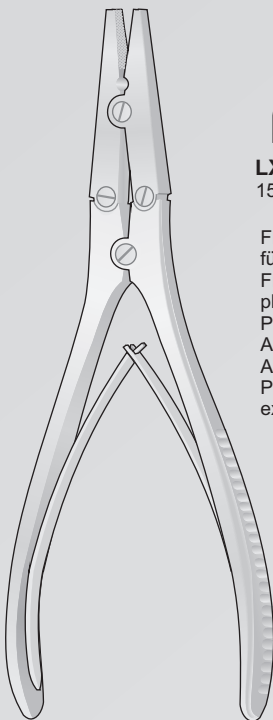

LX-138/LX-139

Wire Cutter
TC

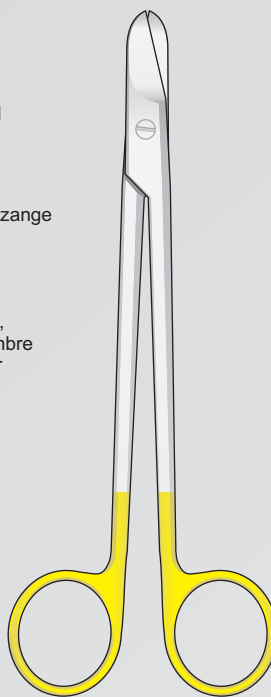

SMITH
FG-160
160 mm

Wire Cutter
TC

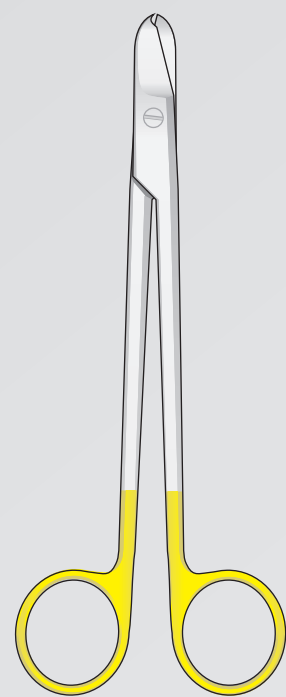

SMITH
FG-161
160 mm

Zangen für schränkhebel platten
Forceps for plattes
Pinze per placche
Pinzas para placas
Pinces à courber pour plaques

Biegezange - Bending pliers - Pinze piegaplacche - Pinces à plier



LS-405
200 mm



LS-406
240 mm

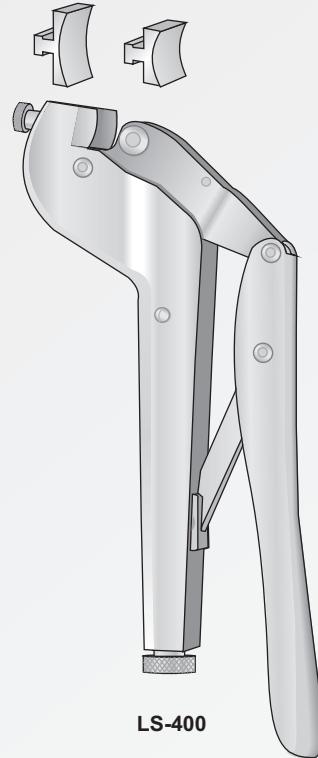

LS-400

Komplett aus rostfreiem Stahl gefertigte und gehärtete Backen sorgen für einen guten Halt.
Spannen und lösen erfolgt mit einer Hand

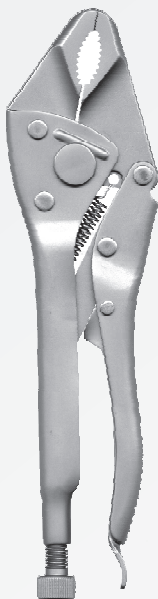

LS-407
180 mm

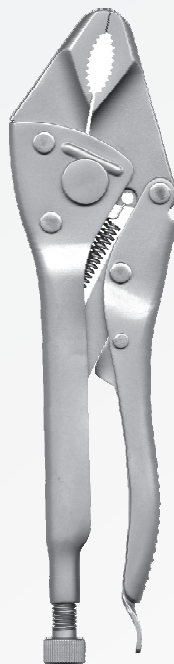

LS-408
200 mm

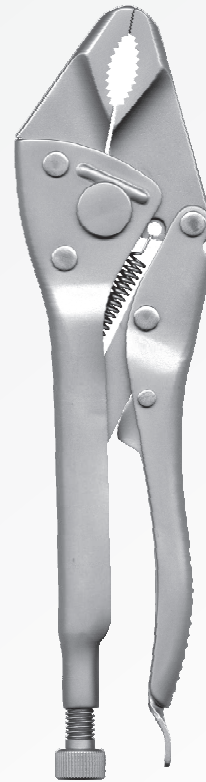

LS-409
240 mm

Biege und schränkhebel
 Forceps for plattes
 Pinze e chiavi per placche
 Pinzas para placas
 Pincas à courber pour plaques

Biegepresse - Bending press - Pressa piegaplacche - Presse pour plier

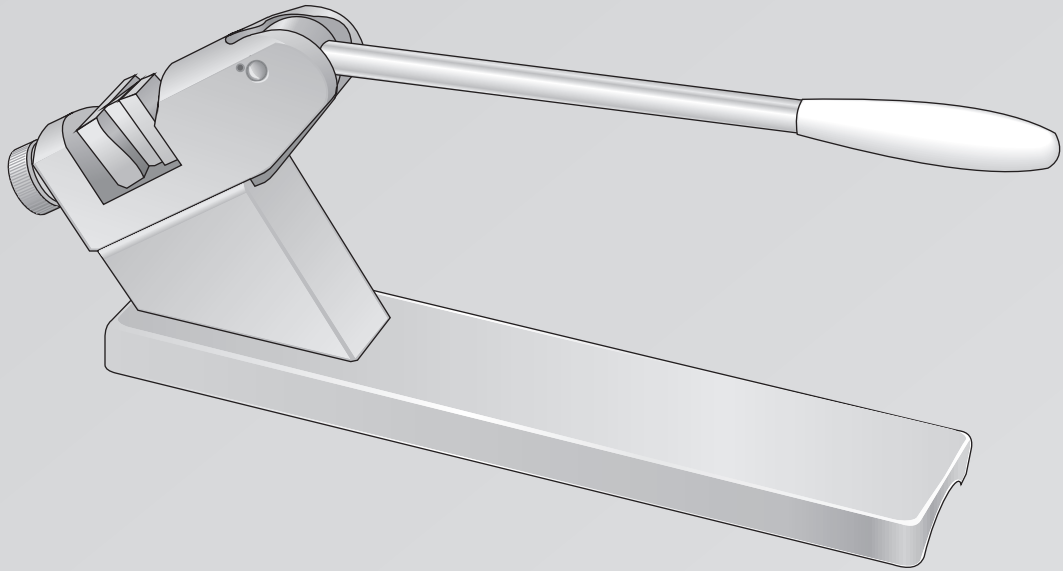

LS-410

For standard plates
Für Standard-Platten

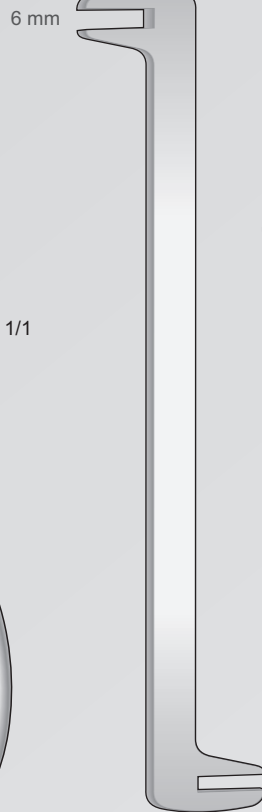

LS-105
250 mm

Bending for Small Plattes

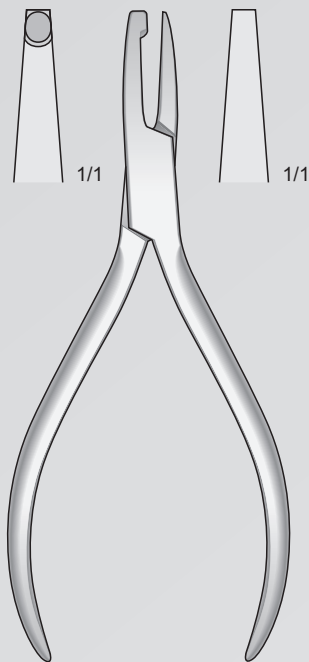

DP-49
140 mm

For standard plates
Für Standard-Platten

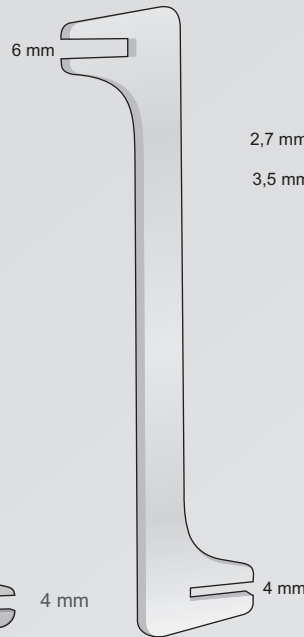

LS-101
180 mm

Bending irons, for small plates
Biege und Schränkhebel für kleine platten

Per placche da
2,7 mm e 3,5 mm

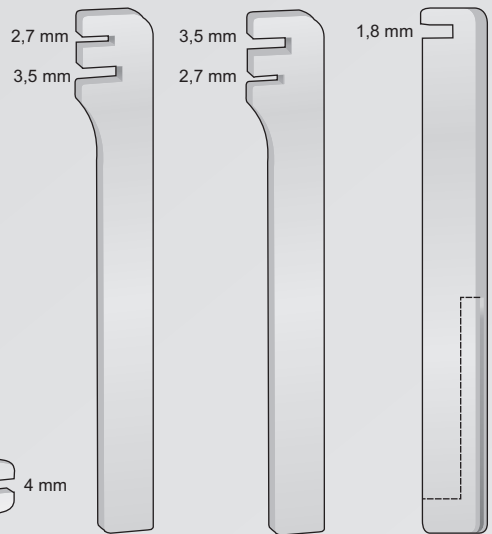

LS-103 100 mm
LS-102 140 mm

LS-123 100 mm
LS-122 140 mm

LS-104
100 mm

Zangen für schränkhebel platten
Forceps for plattes
Pinze per placche
Pinzas para placas
Pinces à courber pour plaques

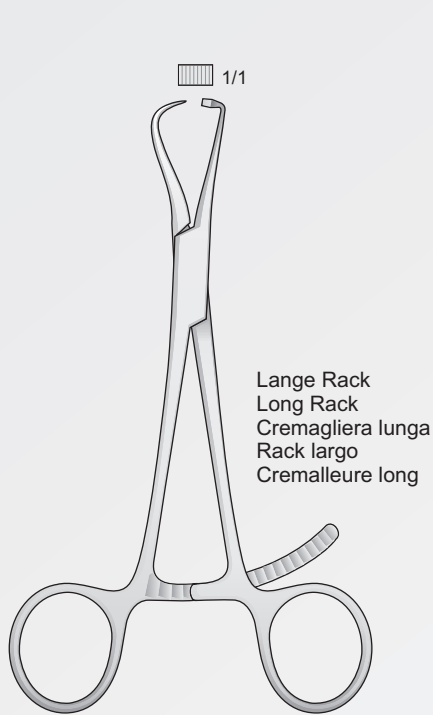

Lange Rack
Long Rack
Cremagliera lunga
Rack largo
Cremalleure long

LS-76L
120 mm

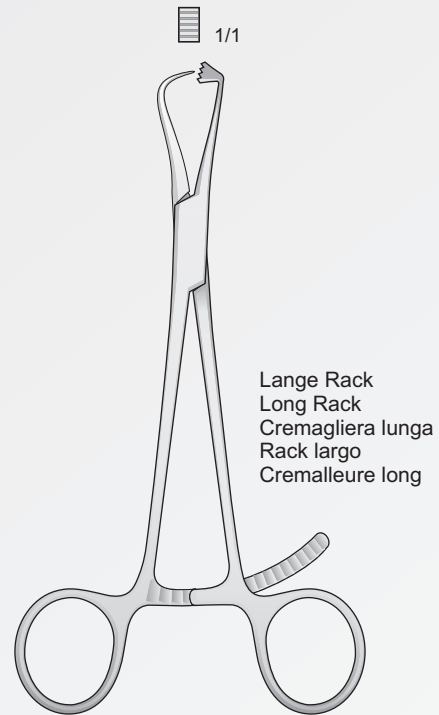

Lange Rack
Long Rack
Cremagliera lunga
Rack largo
Cremalleure long

LS-78L
125 mm

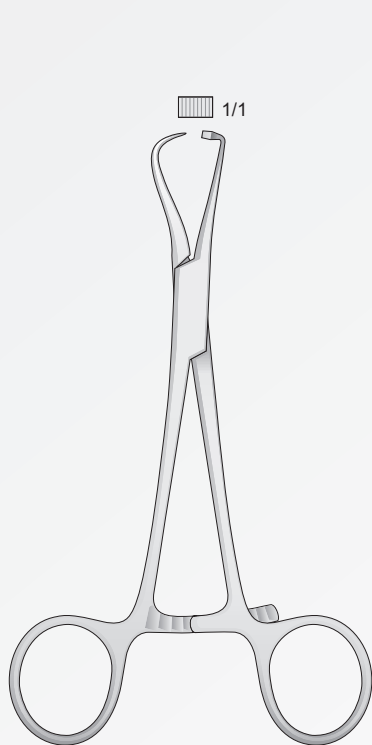

LS-76
120 mm

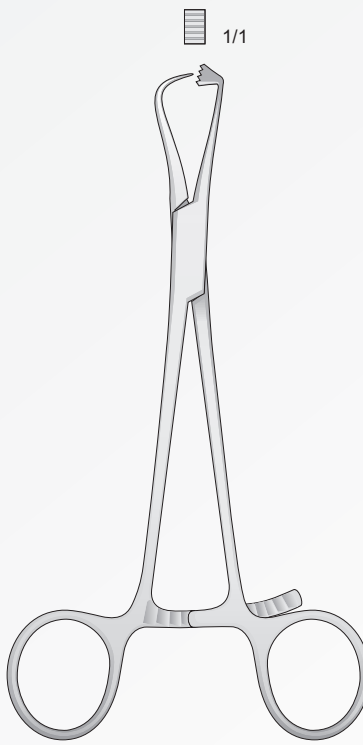

LS-78
125 mm

Kirschner Bohrdrähte
Kirschner Wires Drills
Chiodi di Kirschner
Agujas de Kirschner
Broches de Kirschner

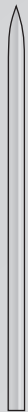

KIRSCHNER
Trokarspitze
Trocar point
Punta trequarti
Punta de tròcar
Pointe de Trocart



KIRSCHNER
Trokarspitze
Trocar point
Punta trequarti
Punta de tròcar
Pointe de Trocart



KIRSCHNER
Lanzenspitze
Lance point
Punte lanceolate
Punta lanceolar
Pointe lancette



Trokarspitze
Trocar point
Punta trequarti
Punta de tròcar
Pointe de Trocart

310 mm



Rundes ende
Round shaft
Punta rotonda
Punta redonda
Pointe ronde

310 mm



Lanzenspitze
Lance point
Punte lanceolate
Punta lanceolar
Pointe lancette

310 mm

| Ø/Diam. | Conf. 10 pz. |
|---------|---------------|
| 0,8 mm | KI-99 |
| 1,0 mm | KI-100 |
| 1,2 mm | KI-102 |
| 1,4 mm | KI-114 |
| 1,5 mm | KI-115 |
| 1,6 mm | KI-116 |
| 1,7 mm | KI-117 |
| 1,8 mm | KI-118 |
| 2,0 mm | KI-120 |
| 2,2 mm | KI-122 |
| 2,5 mm | KI-125 |
| 3,0 mm | KI-130 |

| Ø/Diam. | Conf. 10 pz. |
|---------|--------------|
| 0,8 mm | KI-00 |
| 1,0 mm | KI-01 |
| 1,2 mm | KI-02 |
| 1,4 mm | KI-14 |
| 1,5 mm | KI-15 |
| 1,6 mm | KI-16 |
| 1,7 mm | KI-17 |
| 1,8 mm | KI-18 |
| 2,0 mm | KI-20 |
| 2,2 mm | KI-22 |
| 2,5 mm | KI-25 |
| 3,0 mm | KI-30 |

| Ø/Diam. | Conf. 10 pz. |
|---------|--------------|
| 0,8 mm | KI-40 |
| 1,0 mm | KI-41 |
| 1,2 mm | KI-42 |
| 1,5 mm | KI-43 |
| 1,6 mm | KI-44 |
| 1,8 mm | KI-45 |
| 2,0 mm | KI-46 |
| 2,2 mm | KI-47 |
| 2,5 mm | KI-48 |
| 3,0 mm | KI-49 |

Kirschner Bohrdrähte
Kirschner Wires Drills
Chiodi di Kirschner
Agujas de Kirschner
Broches de Kirschner



KIRSCHNER
Trokarspitze
Trocar point
Punta trequarti
Punta de trócar
Pointe de Trocart



KIRSCHNER
Trokarspitze
Trocar point
Punta trequarti
Punta de trócar
Pointe de Trocart



KIRSCHNER
Lanzenspitze
Lance point
Punte lanceolate
Punta lanceolar
Pointe lancette

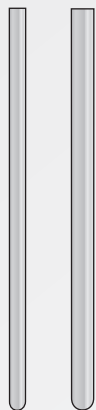

Rundes ende
Round shaft
Punta rotonda
Punta redonda
Pointe ronde

150 mm

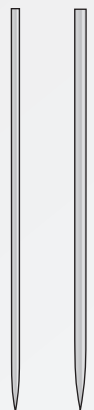

Trokarspitze
Trocar point
Punta trequarti
Punta de trócar
Pointe de Trocart

150 mm



Lanzenspitze
Lance point
Punte lanceolate
Punta lanceolar
Pointe lancette

150 mm

| Ø/Diam. | Conf. 10 pz. |
|---------|--------------|
| 0,8 mm | KI-69 |
| 1,0 mm | KI-70 |
| 1,2 mm | KI-72 |
| 1,4 mm | KI-74 |
| 1,5 mm | KI-75 |
| 1,6 mm | KI-76 |
| 1,7 mm | KI-77 |
| 1,8 mm | KI-78 |
| 2,0 mm | KI-80 |
| 2,2 mm | KI-82 |
| 2,5 mm | KI-85 |
| 3,0 mm | KI-90 |

| Ø/Diam. | Conf. 10 pz. |
|---------|--------------|
| 0,8 mm | KI-60 |
| 1,0 mm | KI-61 |
| 1,2 mm | KI-62 |
| 1,4 mm | KI-63 |
| 1,6 mm | KI-64 |
| 1,8 mm | KI-65 |
| 2,0 mm | KI-66 |
| 2,2 mm | KI-67 |
| 2,5 mm | KI-68 |
| 3,0 mm | KI-71 |

| Ø/Diam. | Conf. 10 pz. |
|---------|--------------|
| 0,8 mm | KI-29 |
| 1,0 mm | KI-31 |
| 1,2 mm | KI-32 |
| 1,5 mm | KI-33 |
| 1,6 mm | KI-34 |
| 1,8 mm | KI-35 |
| 2,0 mm | KI-36 |
| 2,2 mm | KI-37 |
| 2,5 mm | KI-38 |
| 3,0 mm | KI-39 |

Kirschner Bohrdrähte
Kirschner Wires Drills
Chiodi di Kirschner
Agujas de Kirschner
Broches de Kirschner



Runde
Round
Rotonda
Redonda
Ronde

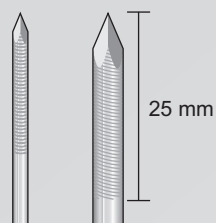

Mit Trokarspitze
With trocar point
Con punte lanceolate
A' pointe trocar
Puntas de trocar

Mit rundem Ende
With round shaft
Con punta rotonda
A' extrémité ronde
Con vástago redondo



| KIRSCHNER | | | |
|---------------|------|-------|------------|
| Codice | Ø mm | Lung. | Lung. filo |
| KI-220 | 1,5 | 150 | 5 |
| KI-221 | 1,6 | 150 | 15 |
| KI-222 | 2 | 150 | 15 |
| KI-223 | 2 | 200 | 15 |

| KIRSCHNER | | | |
|---------------|------|-------|------------|
| Codice | Ø mm | Lung. | Lung. filo |
| KI-224 | 2,5 | 200 | 25 |
| KI-225 | 2,5 | 230 | 25 |
| KI-226 | 2,5 | 300 | 25 |
| KI-227 | 3,0 | 300 | 25 |
| KI-228 | 3,5 | 300 | 25 |
| KI-229 | 4,0 | 260 | 25 |
| KI-233 | 4,5 | 300 | 25 |

Kirschner Bohrdrähte
Kirschner Wires Drills
Chiodi di Kirschner
Agujas de Kirschner
Broches de Kirschner

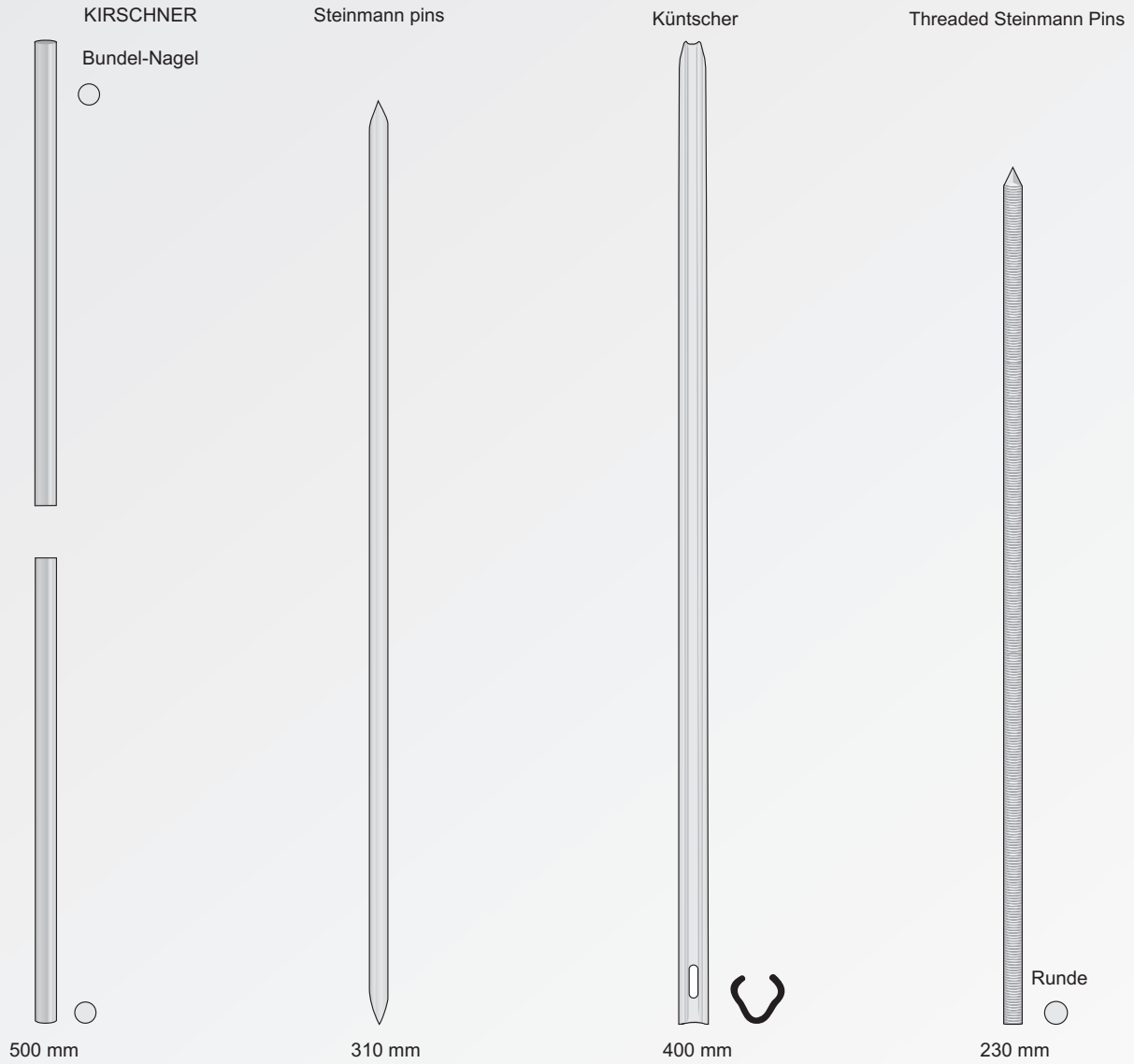

| Ø/Diam. | Conf. 10 pz. |
|---------|--------------|
| 2,0 mm | KI-50 |
| 2,5 mm | KI-51 |
| 3,0 mm | KI-52 |
| 3,5 mm | KI-53 |
| 4,0 mm | KI-54 |
| 4,5 mm | KI-55 |
| 5,0 mm | KI-56 |
| 5,5 mm | KI-57 |
| 6,0 mm | KI-58 |

| Ø/Diam. | Conf. 1 pz. |
|---------|---------------|
| 3,5 mm | KI-280 |
| 4,0 mm | KI-282 |
| 4,5 mm | KI-284 |
| 5,0 mm | KI-286 |
| 6,0 mm | KI-288 |
| 6,5 mm | KI-290 |

| Ø/Diam. | Conf. 1 pz. |
|---------|---------------|
| 6,0 mm | KI-252 |
| 7,0 mm | KI-254 |
| 8,0 mm | KI-256 |
| 9,0 mm | KI-258 |
| 10 mm | KI-260 |
| 11 mm | KI-262 |
| 12 mm | KI-264 |

| Ø/Diam. | Conf. 1 pz. |
|---------|---------------|
| 2,0 mm | KI-160 |
| 2,5 mm | KI-161 |

Bohrdrähte und kochennägel mit Gewinde
Threaded Wires and pines
Chiodi filettati Schanz
Agujas y clavos con rosca
Broches et clous avec filetage

Negativo

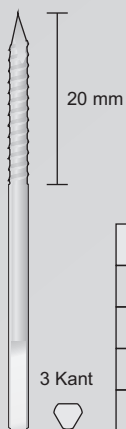

| SCHANZ | | | |
|---------------|------|-------|------------|
| Codice | Ø mm | Lung. | Lung. filo |
| KI-230 | 3 | 60 | 20 |
| KI-231 | 3 | 80 | 20 |
| KI-232 | 4 | 60 | 25 |

Negativo



| SCHANZ | | | |
|---------------|------|-------|------------|
| Codice | Ø mm | Lung. | Lung. filo |
| KI-293 | 2 | 150 | 50 |
| KI-294 | 3 | 150 | 50 |
| KI-295 | 3,5 | 150 | 50 |
| KI-296 | 4 | 150 | 50 |
| KI-297 | 4,5 | 150 | 50 |
| KI-298 | 5 | 150 | 50 |

Negativo



| SCHANZ | | | |
|---------------|------|-------|------------|
| Codice | Ø mm | Lung. | Lung. filo |
| KI-238 | 2 | 150 | 50 |
| KI-240 | 3 | 150 | 50 |
| KI-242 | 3,5 | 150 | 50 |
| KI-244 | 4 | 150 | 50 |
| KI-246 | 4,5 | 150 | 50 |
| KI-248 | 5 | 150 | 50 |

Positivo

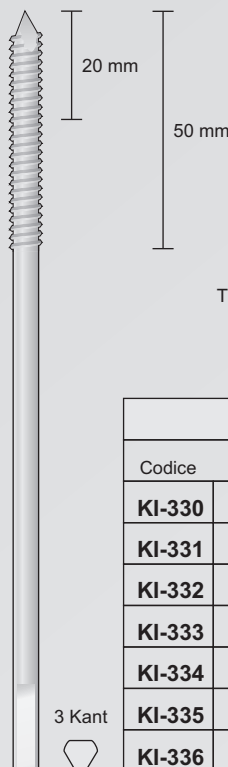

Thread - Ø is 0,5 mm
more than pin - Ø

| SCHANZ | | | |
|---------------|------|-------|------------|
| Codice | Ø mm | Lung. | Lung. filo |
| KI-330 | 2 | 150 | 20 |
| KI-331 | 3 | 150 | 20 |
| KI-332 | 3,5 | 150 | 50 |
| KI-333 | 4 | 150 | 25 |
| KI-334 | 4 | 150 | 50 |
| KI-335 | 4,5 | 150 | 50 |
| KI-336 | 5 | 150 | 50 |

Cerclage Instrumente
Cerclage instruments
Strumenti per cerchiaggio
Instrumentos para cerclaje
Instruments pour cerclage

Bohrdrähte und Knochennägel mit Gewinde
Threaded Wires and pins
Chiodi filettati Schanz
Agujas y clavos con rosca
Broches et clous avec filetage

Positivo

Thread - Ø is 0,5 mm
more than pin - Ø

Steinmann Pins with Central Threa
with Trocar Point

Sterilisation-Bohrdrahtspender
Sterilization Wire Drill dispenser
Contenitore per sterilizzazione chiodi
Esterilización - Dispensador de Agujas
Stérilisation - Distributeur de broches

Ø 10 mm

Draht weich
Wire soft
Filo malleabile
per compattare l'osso
Hilos de cerclaje
Fil à os

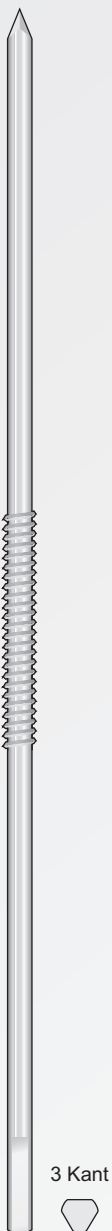

| STEINMANN PINS | | |
|----------------|------|-------|
| Codice | Ø mm | Lung. |
| KI-175 | 3 | 150 |
| KI-176 | 3 | 180 |
| KI-177 | 3 | 200 |
| KI-178 | 3 | 230 |
| KI-179 | 3,5 | 150 |
| KI-180 | 3,5 | 180 |
| KI-181 | 3,5 | 200 |
| KI-182 | 3,5 | 230 |
| KI-183 | 4 | 150 |
| KI-184 | 4 | 180 |
| KI-185 | 4 | 200 |
| KI-186 | 4 | 230 |
| KI-187 | 4 | 250 |
| KI-188 | 4,5 | 150 |
| KI-189 | 4,5 | 180 |
| KI-190 | 4,5 | 200 |
| KI-191 | 4,5 | 230 |
| KI-192 | 4,5 | 250 |
| KI-193 | 4,5 | 300 |
| KI-194 | 5 | 150 |
| KI-195 | 5 | 180 |
| KI-196 | 5 | 200 |
| KI-197 | 5 | 230 |
| KI-198 | 5 | 250 |
| KI-199 | 5 | 300 |

3 Kant

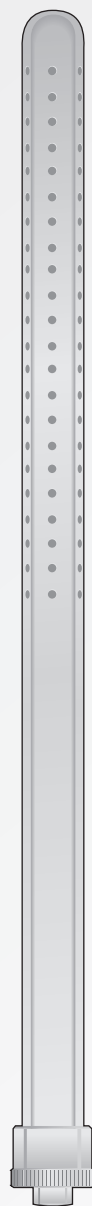

KI-300
320 mm
KI-301
190 mm

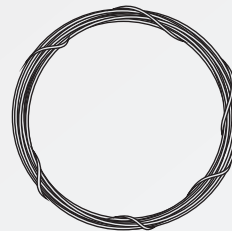

10 mt.

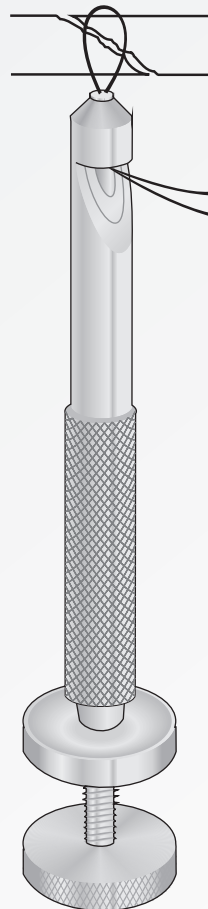

LOUTE
KI-322
220 mm

| Ø/Diam. | Codice |
|---------|---------------|
| 0,2 mm | KI-202 |
| 0,3 mm | KI-203 |
| 0,4 mm | KI-204 |
| 0,5 mm | KI-205 |
| 0,6 mm | KI-206 |
| 0,7 mm | KI-207 |
| 0,8 mm | KI-208 |
| 0,9 mm | KI-209 |
| 1,0 mm | KI-210 |
| 1,2 mm | KI-211 |
| 1,5 mm | KI-212 |

Drahtspanninstrument
Bone Wire tighteners
Strumenti tendifilo
Tensor cierra hilos
Tendeur serre fils

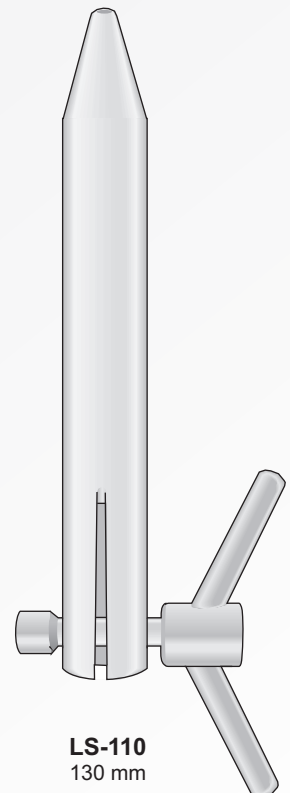

LS-110
130 mm

Spiralbohrer
Twist drills
Maschiatori - Taps
Formadores de guia para tornillos
Taraud pour vis

Punte elicoidali con innesto rapido

Mit AO schaft
Drill bits
Attacco AO

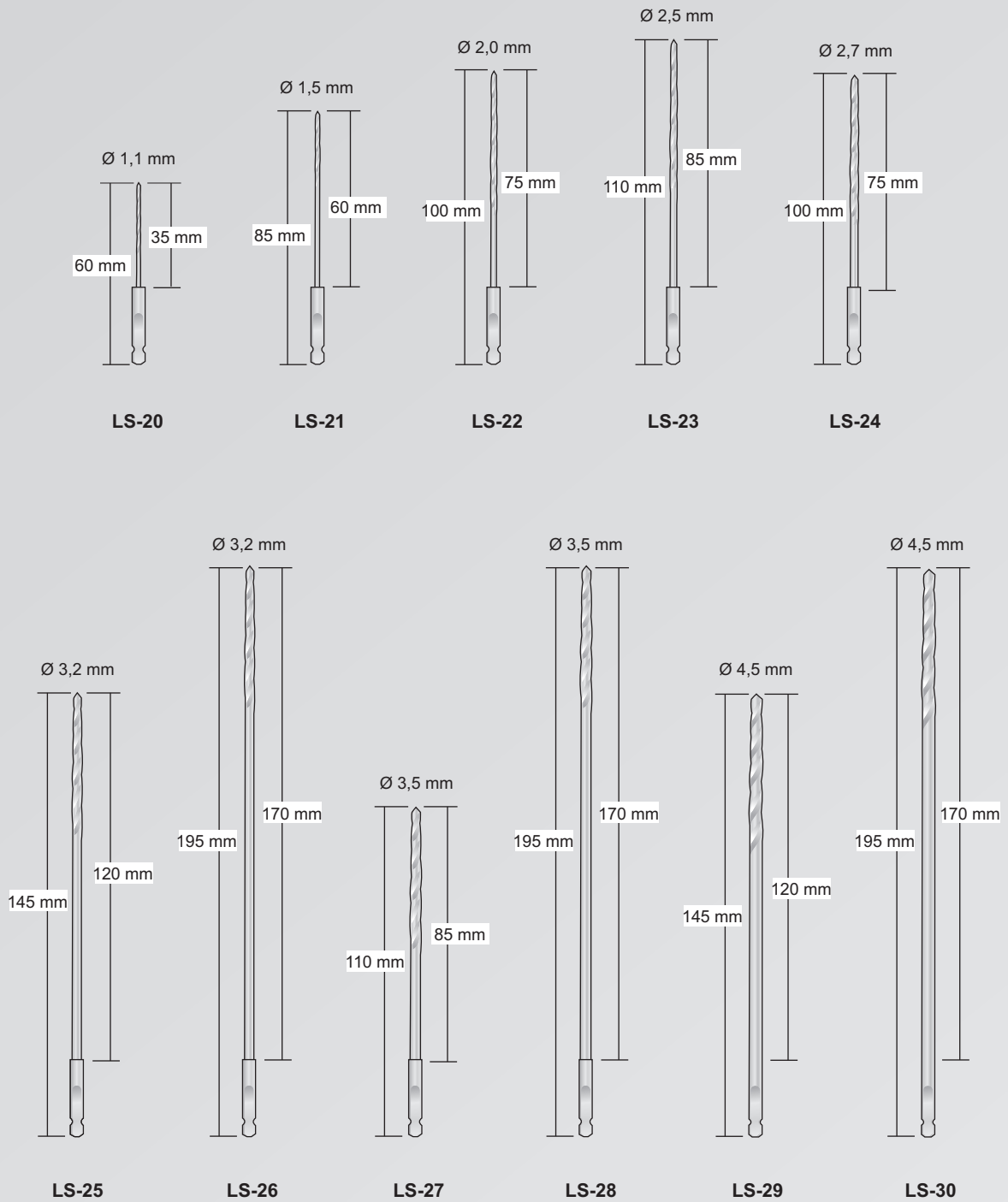

Punte elicoidali

Mit rundschaft
Drill bits
Con attacco rotondo

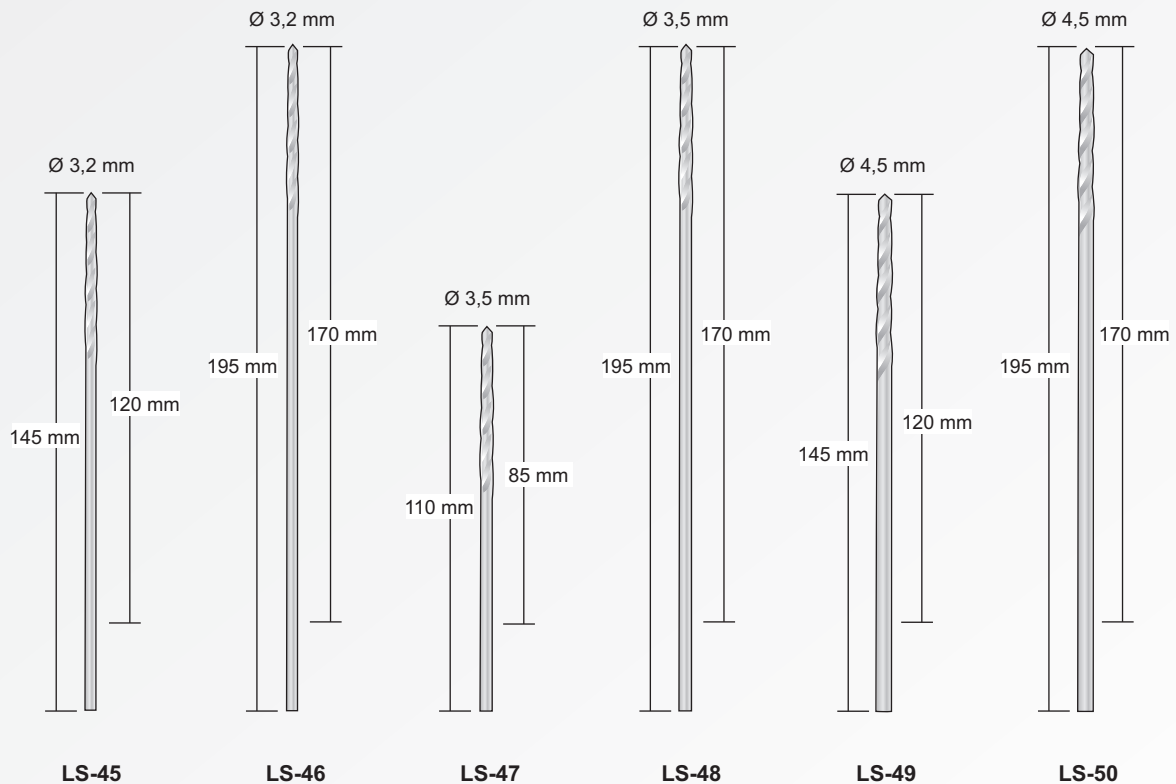
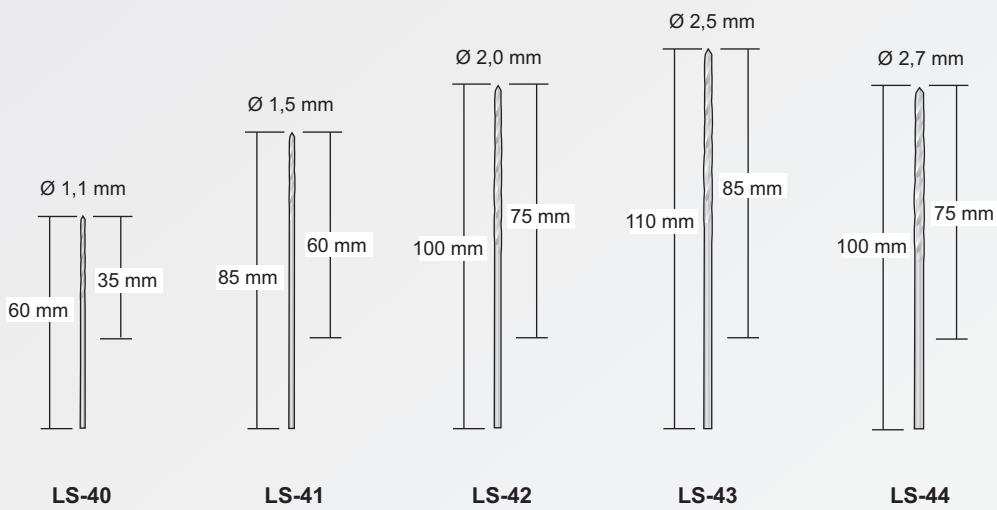

Spiralbohrer
Twist drills
Maschiatori - Taps
Formadores de guia para tornillos
Taraud pour vis

Mit rundschaft
Drill bits
Con attacco rotondo

Punte elicoidali

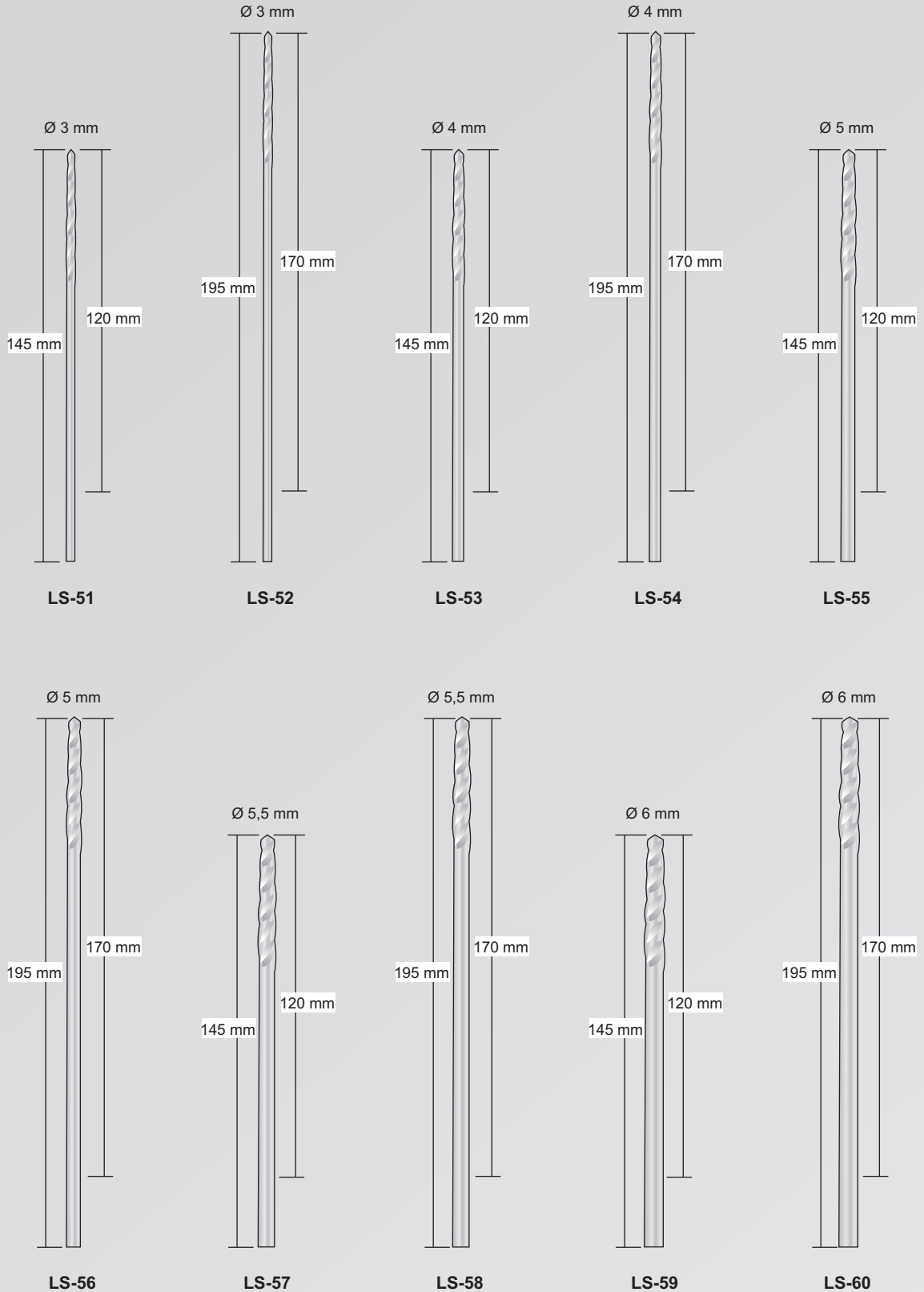

Dental schaft
Attacco Dentale

Ø 1,5 mm



LS-32
50 mm

Ø 2,0 mm



LS-33
55 mm

Meßlehre für Kirschnerdrähte
Measuring Gauge for nails
Misuratore per chiodi Kirschner



KI-10

Mit AO schaft
Attacco AO

Ø 1,5 mm



LS-10
65 mm

Ø 2 mm



LS-11
70 mm

Ø 2,7 mm



LS-12
100 mm

Passo della vite
a 1,25 mm

Ø 3,5 mm



LS-13
110 mm

Passo della vite
a 1,75 mm

Ø 3,5 mm

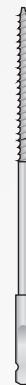

LS-14
110 mm

Ø 4,5 mm



LS-15
130 mm

Ø 4,5 mm



LS-16
130 mm

Ø 6,5 mm



LS-17
170 mm

Orthopädie Osteosynthese
Bone Surgery Osteosynthesis
Ortopedia Osteosintesi
Cirurgia òsea Osteosintesis
Orthopédie Ostéosynthèse

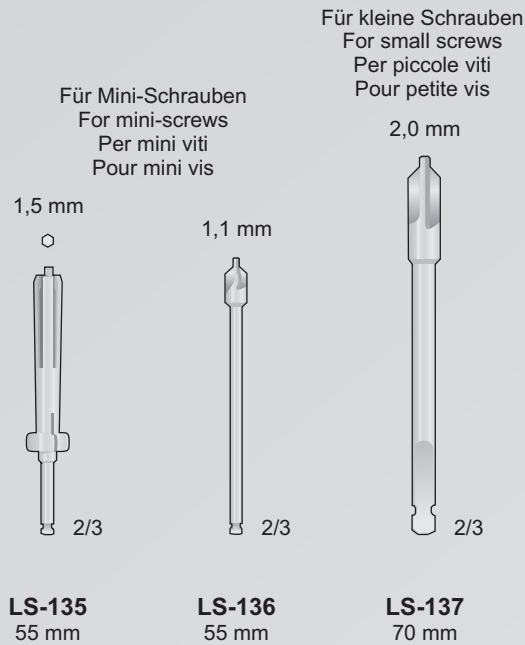

Für Malleolarschrauben
For malleolar screws
Per viti malleolari
Pour vis à malléole

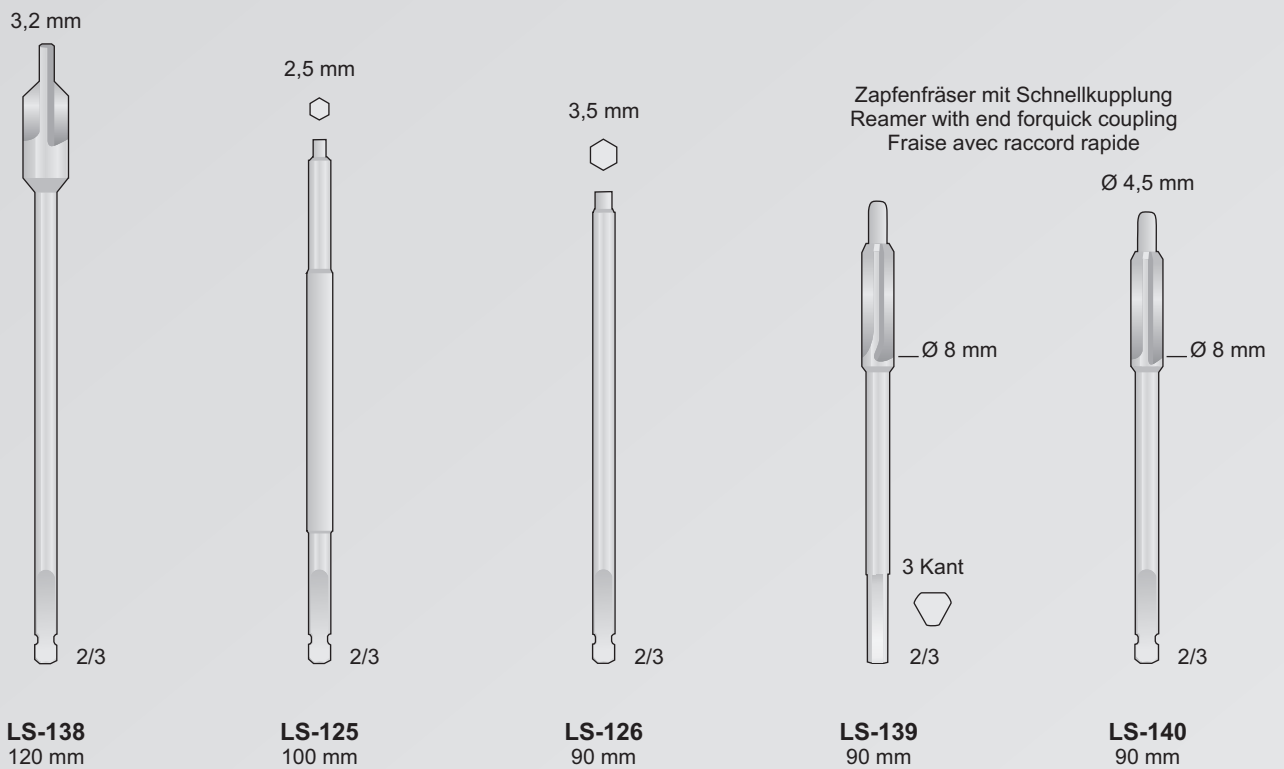



BONTEMPI
CHIRURGISCHE INSTRUMENTE

Otologie
Otology
Otologia
Otologia
Otologie

Instrumente für Otologie
Otology instruments
Strumenti per otologia
Instrumentos auriculares
Instrumentes pour l'otologie

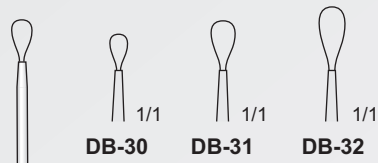

DB-30 **DB-31** **DB-32**

Ohrschlingen
Ear loobs anses
Anse auricolari
Ansas auricolares



BILLEAU
DB-30/DB-32
160 mm



DB-36 **DB-37** **DB-38** **DB-39**
130 mm 130 mm 130 mm 130 mm

Löffel
Curettes
Curette
Curetas
Curettes



SHAPLEIGH
DB-36/DB-39
130 mm

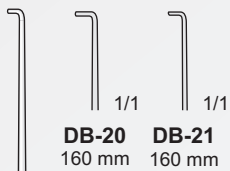

DB-20 **DB-21**
160 mm 160 mm

Ohrhebel
Ear hooks
Uncini
Ganchitos
Crochets



DAY
DB-20/DB-21
160 mm

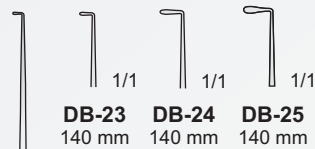

DB-23 **DB-24** **DB-25**
140 mm 140 mm 140 mm

Ohrhebel
Ear hooks
Uncini
Ganchitos
Crochets



LUCAE
DB-23/DB-25
140 mm

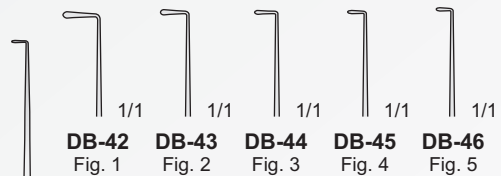

DB-42 **DB-43** **DB-44** **DB-45** **DB-46**
Fig. 1 Fig. 2 Fig. 3 Fig. 4 Fig. 5

Ohrhebel
Ear hooks
Uncini
Ganchitos
Crochets



WAGENER
DB-42/DB-46
140 mm

| | |
|----------------|-------------------|
| Palpatorischen | Mikro-Küretten |
| Palpatory | Micro Curettes |
| Palpatori | Micro Cucchai |
| Palpación | Micro Cucharillas |
| Palpatoire | Micro Curettes |



**GRAEFE
NK-245**
130 mm



A-1
125 mm



713-101



713-102



717-100

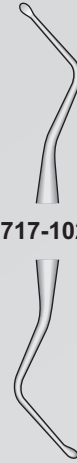

717-102



717-112



**SHEA
FR-158**
160 mm



**SHEA
FR-159**
160 mm

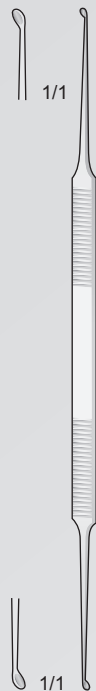

**HOUSE
FR-160/FR-161**
150 mm

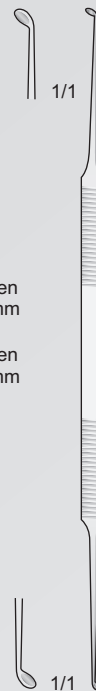

**HOUSE
FR-162/FR-163**
150 mm

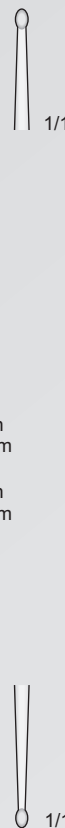

**HOUSE
FR-164/FR-165**
180 mm

FR-160
Leicht gebogen
1,0 mm/1,2 mm
FR-161
Leicht gebogen
1,5 mm/1,8 mm

FR-162
Stark gebogen
1,0 mm/1,2 mm
FR-163
Stark gebogen
1,5 mm/1,8 mm

FR-164
Stark gebogen
Strong curved
FR-165
Leicht gebogen
Slightly curved

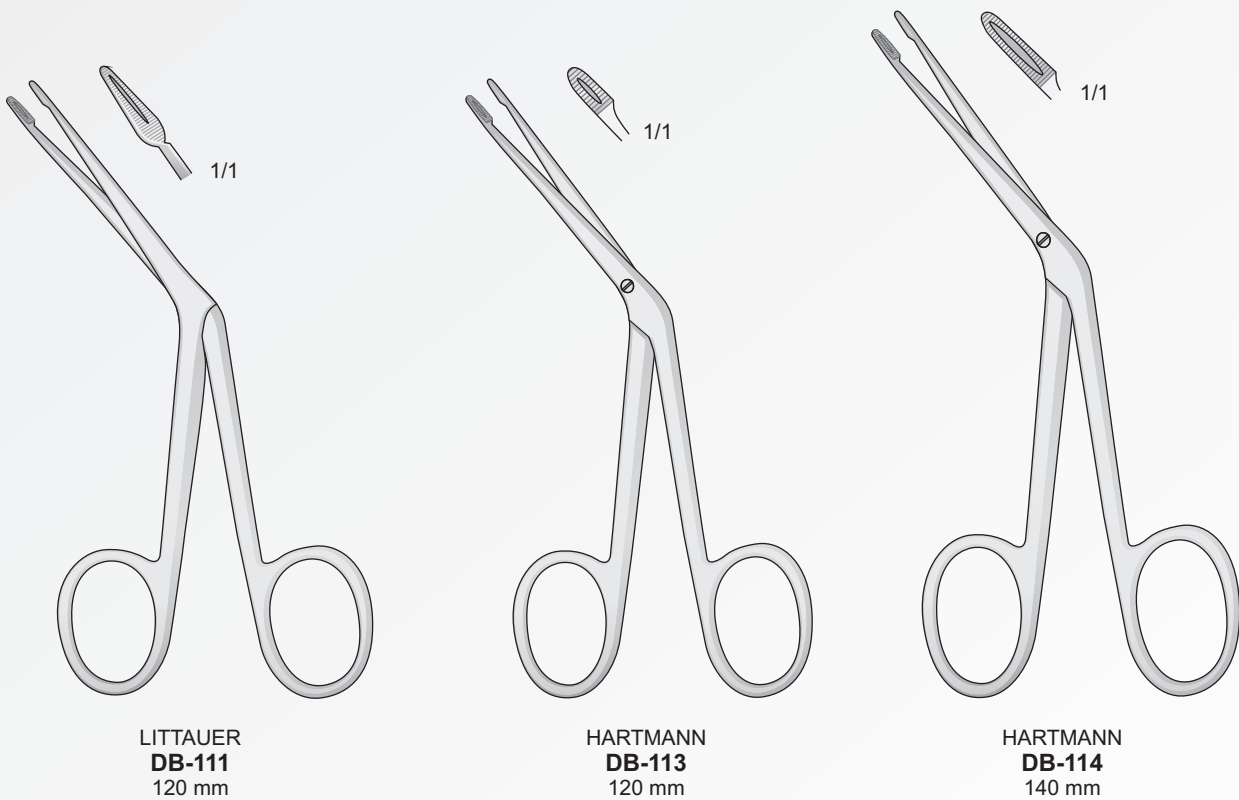
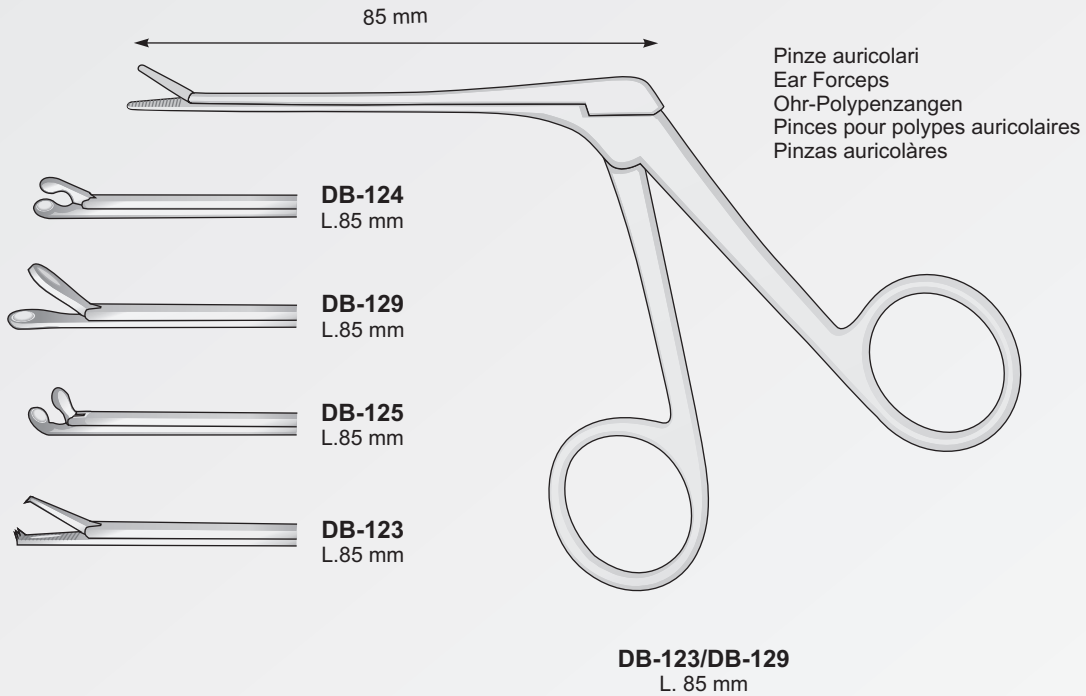

Ohr Instrumente
Ear instruments
Strumenti per otologia
Instrumental para auriculàres
Pinces auriculaires

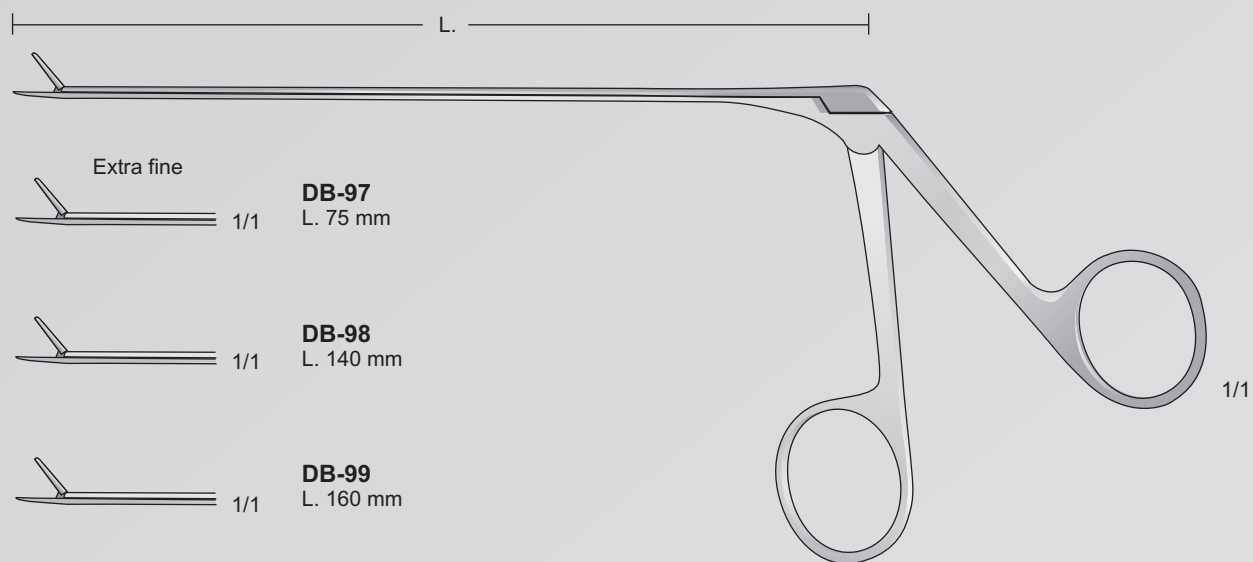

MICRO-HARTMANN
DB-97/DB-99

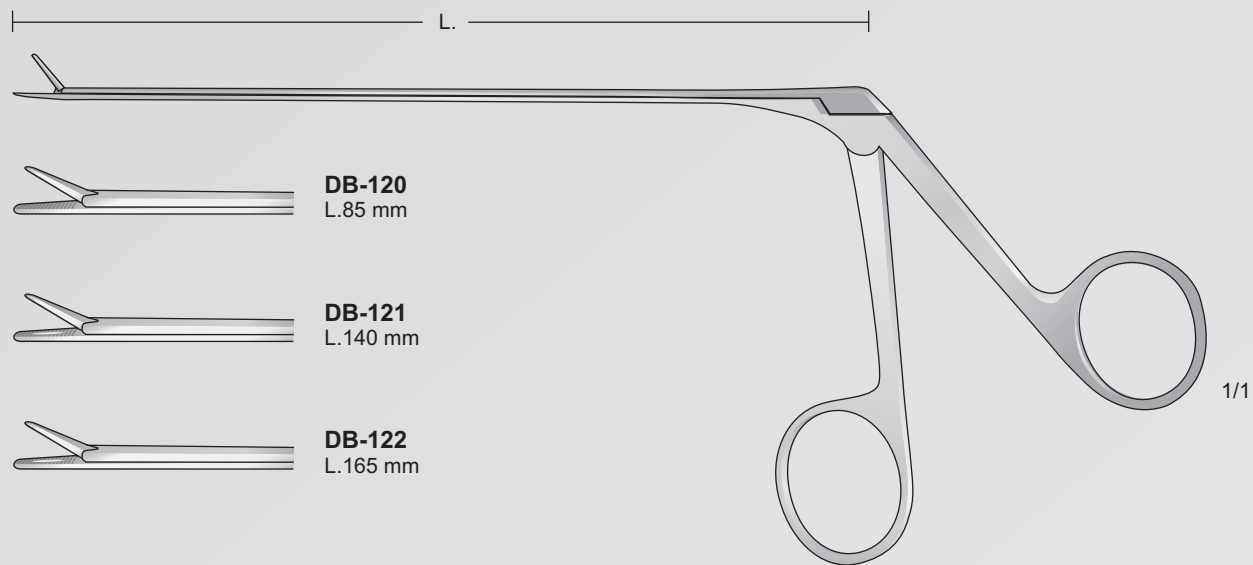

DB-120/DB-122

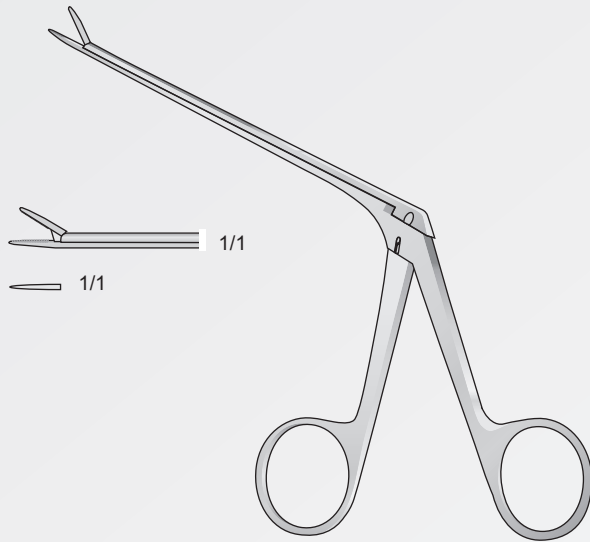

DB-100
80 mm

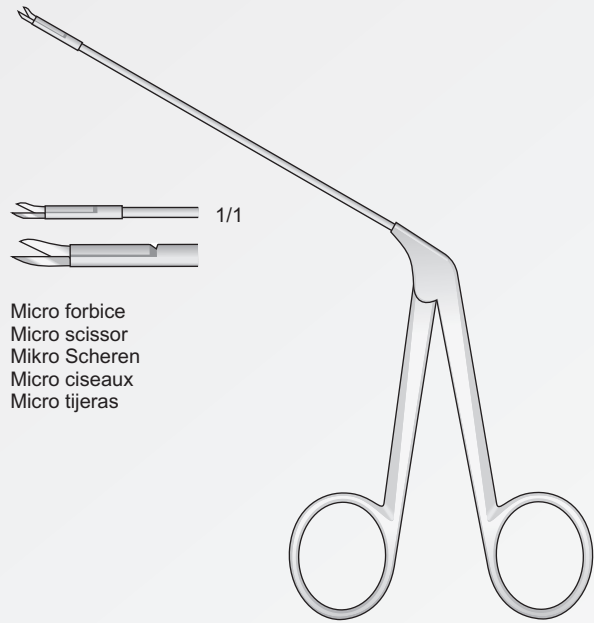

Micro forbice
Micro scissor
Mikro Scheren
Micro ciseaux
Micro tijeras

BELLUCCI
DB-106
80 mm

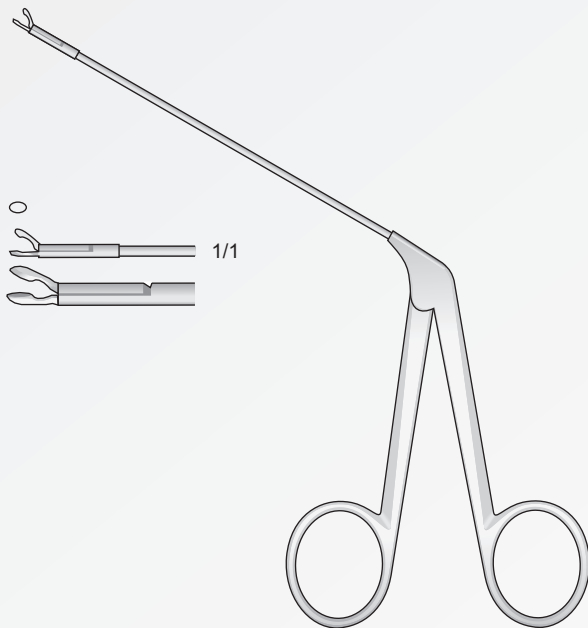

WULLSTEIN
DB-107
80 mm

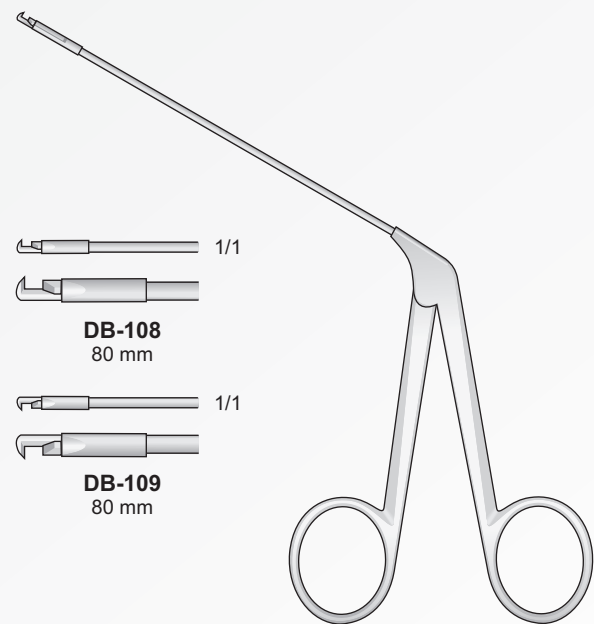

DB-108
80 mm

DB-109
80 mm

DIETER
DB-108/DB-109
80 mm

Rinologia
Rhinology
Rhinologie
Rhinologie
Rinologia

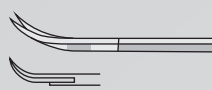

Mikro-Schere
FAHLBUSCH
FF-401
165 mm

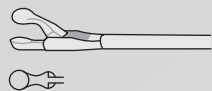

Scharfe Zange
NICOLA
FF-402
165 mm

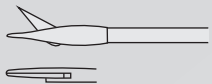

Mikro-Schere
NICOLA
FF-403
165 mm

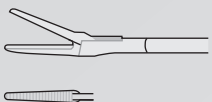

Faßzange
YASARGIL-NICOLA
FF-404
165 mm

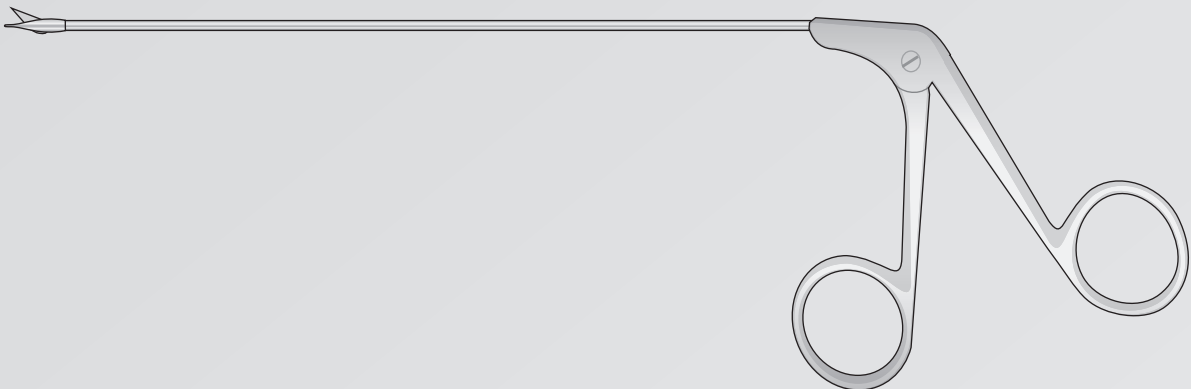
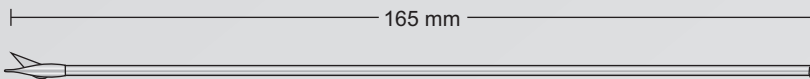

NICOLA
FF-403
165 mm

| | |
|-------------------------------|------------|
| Ohr Instrumente | Rinologia |
| Ear instruments | Rhinology |
| Strumenti per otologia | Rhinologie |
| Instrumental para auriculàres | Rhinologie |
| Pinces auriculaires | Rinologia |

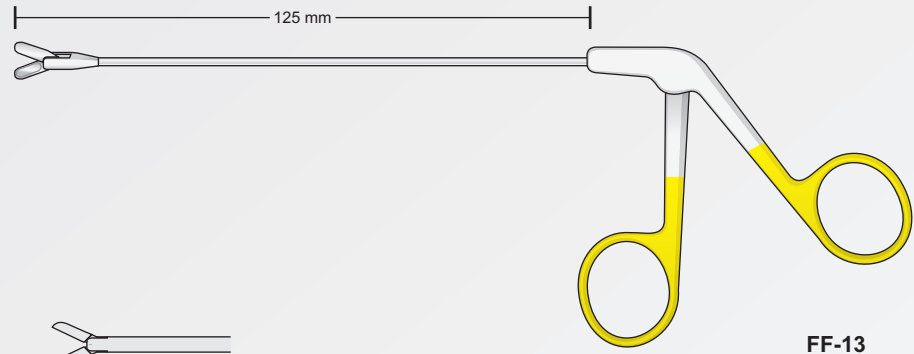

FF-13

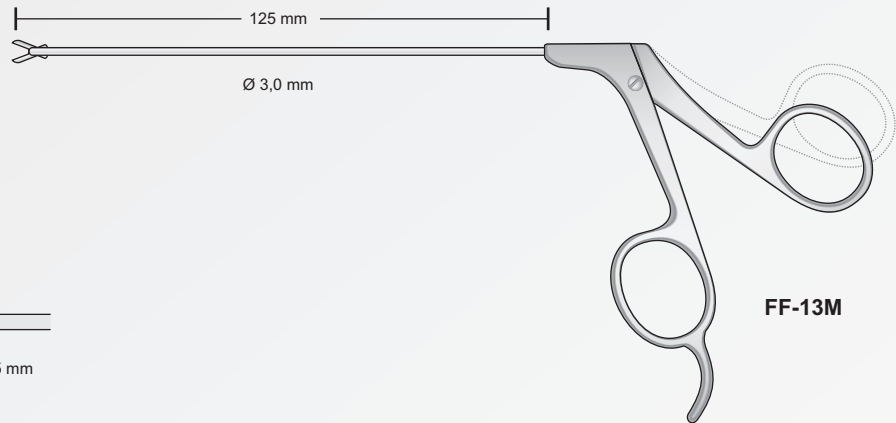
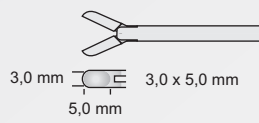

FF-13M

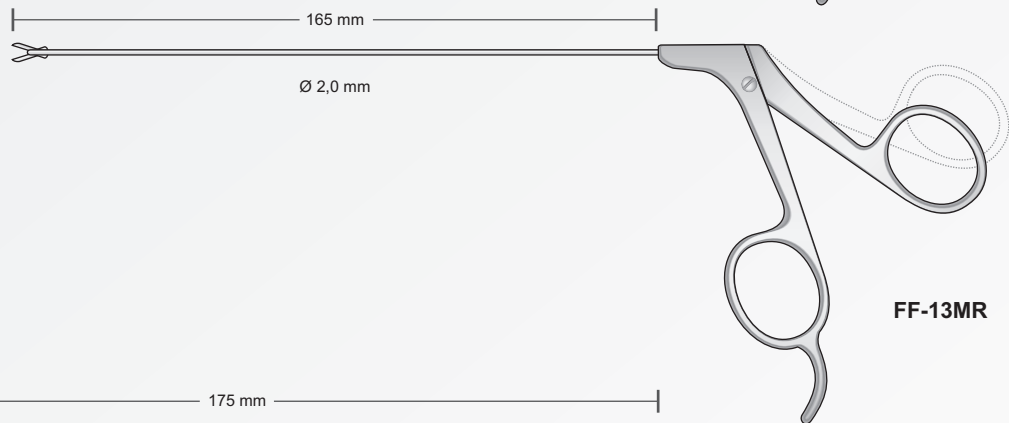
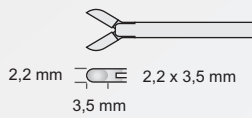

FF-13MR

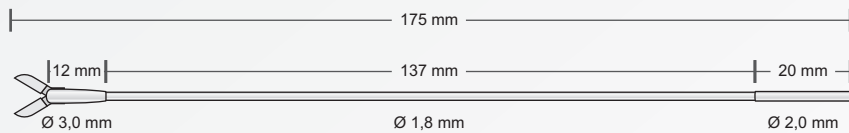

FF-13MRT

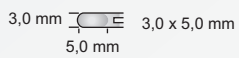



BONTEMPI
CHIRURGISCHE INSTRUMENTE

Ophtalmologie
Ophthalmology
Oftalmologia
Ophtalmologia
Ophtlamologie

Micro Scheren
Micro scissors
Micro forbici
Micro tijeras
Micro ciseaux

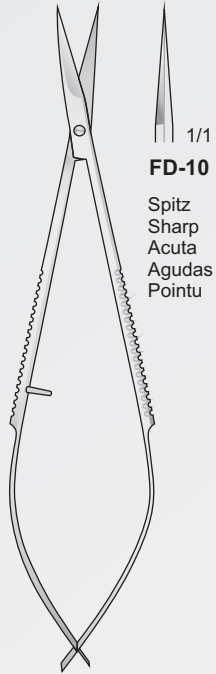

NOYES
FD-10
120 mm

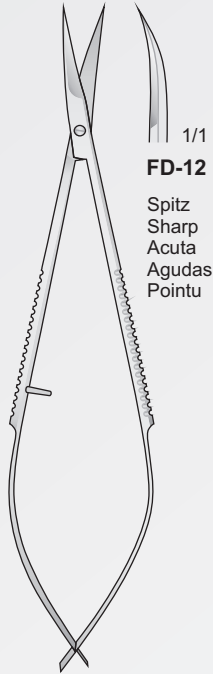

NOYES
FD-12
120 mm

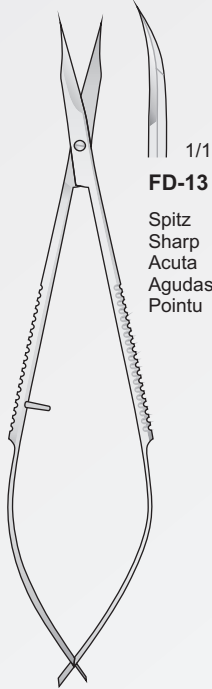

WESTCOTT
FD-13
120 mm

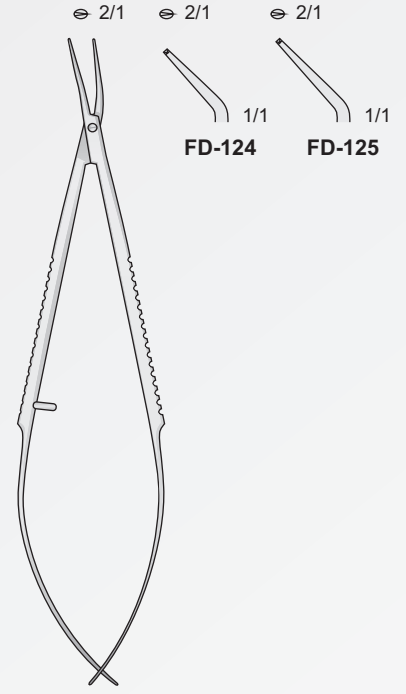

FD-124/FD-125
110 mm

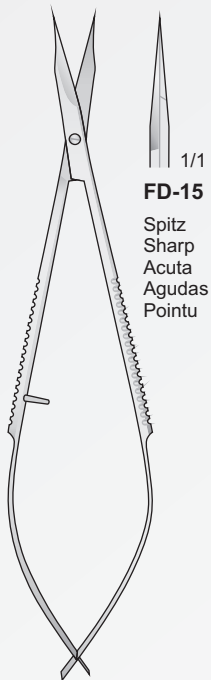

WESTCOTT
FD-15
120 mm

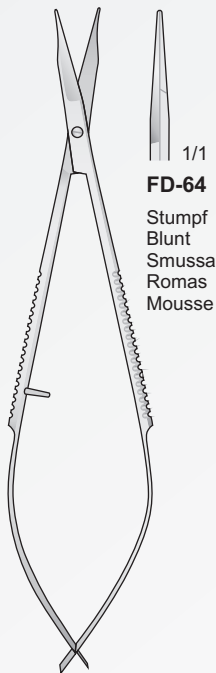

WESTCOTT
FD-64
120 mm

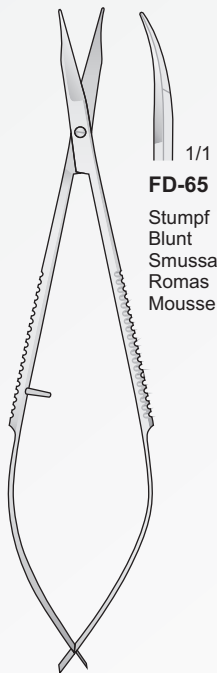

WESTCOTT
FD-65
120 mm



FD-126/FD-127
110 mm

Micro Scheren
Micro scissors
Micro forbici
Micro tijeras
Micro ciseaux

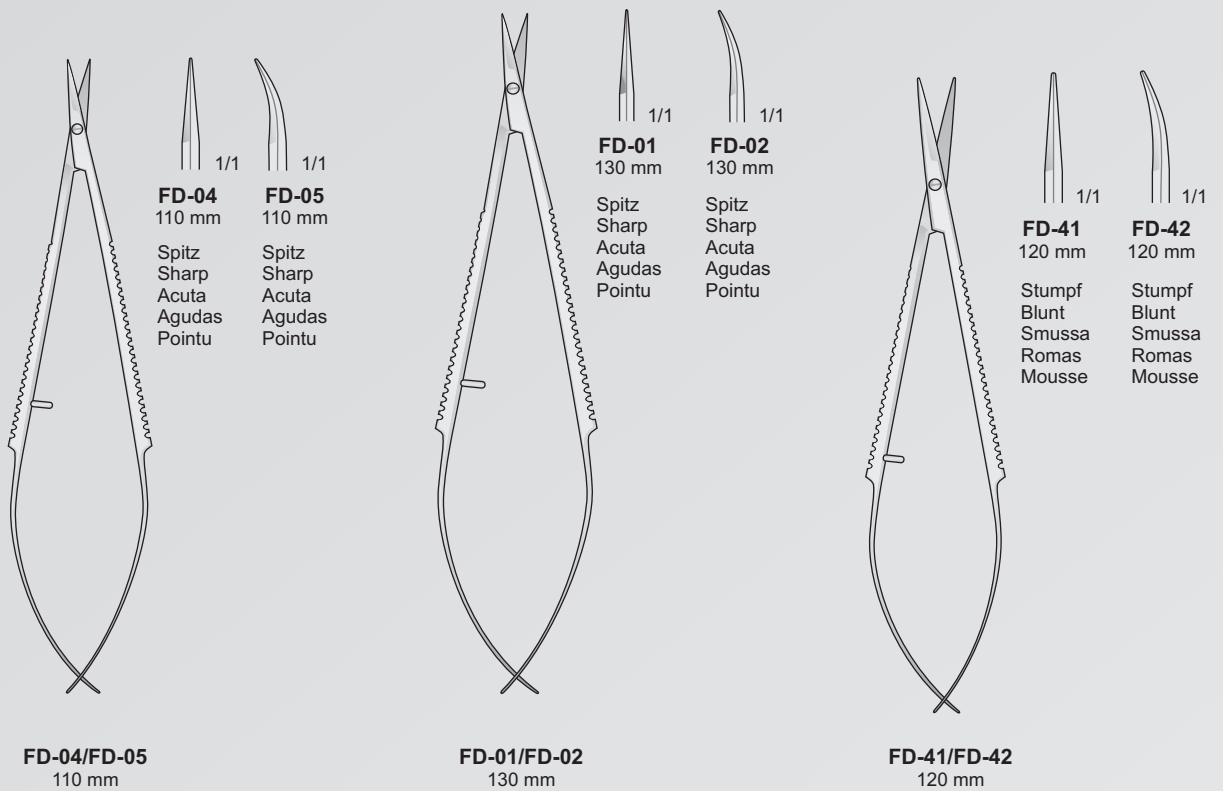
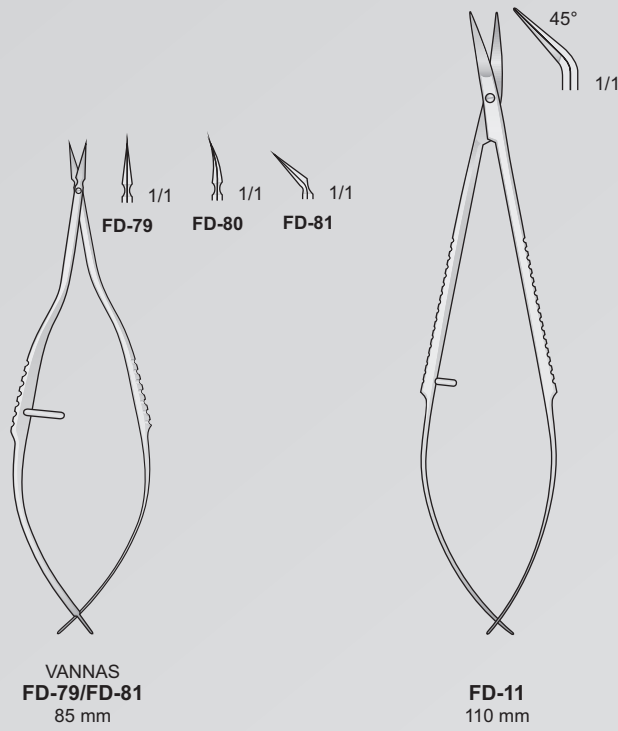

Micro Scheren
Micro scissors
Micro forbici
Micro tijeras
Micro ciseaux

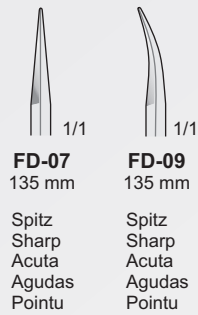
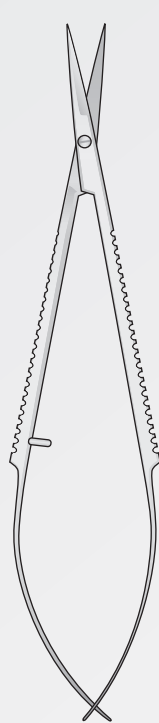

FD-07/FD-09
135 mm

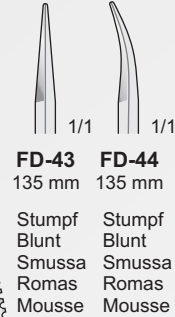
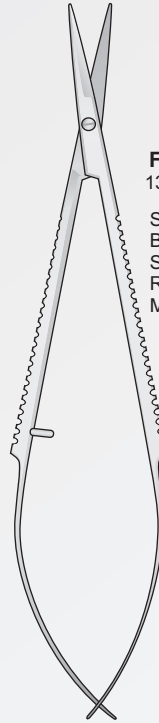

FD-43/FD-44
135 mm

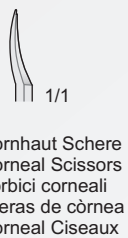
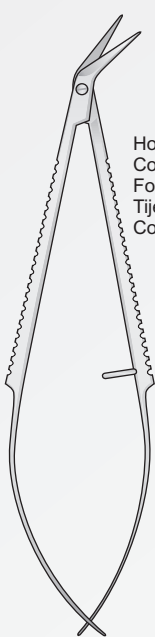

CASTROVIEJO
FD-66
110 mm

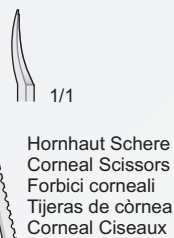
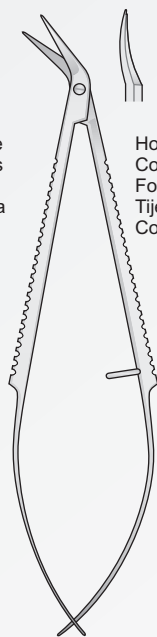

CASTROVIEJO
FD-67
110 mm

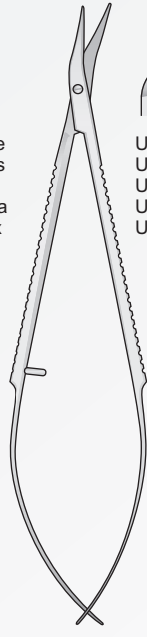

CASTROVIEJO
FD-68
110 mm

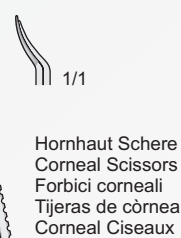
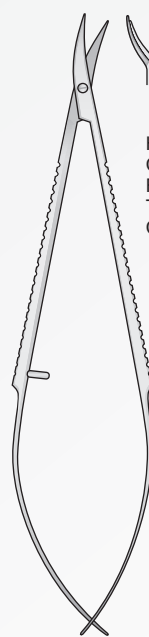

TROUTMAN
FD-69
110 mm

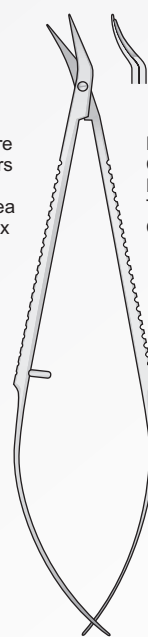

TROUTMAN
FD-70
110 mm

Präparierscheren
Dissecting Scissors
Forbici per dissezione
Tijeras para preparaciones
Ciseaux à dissection

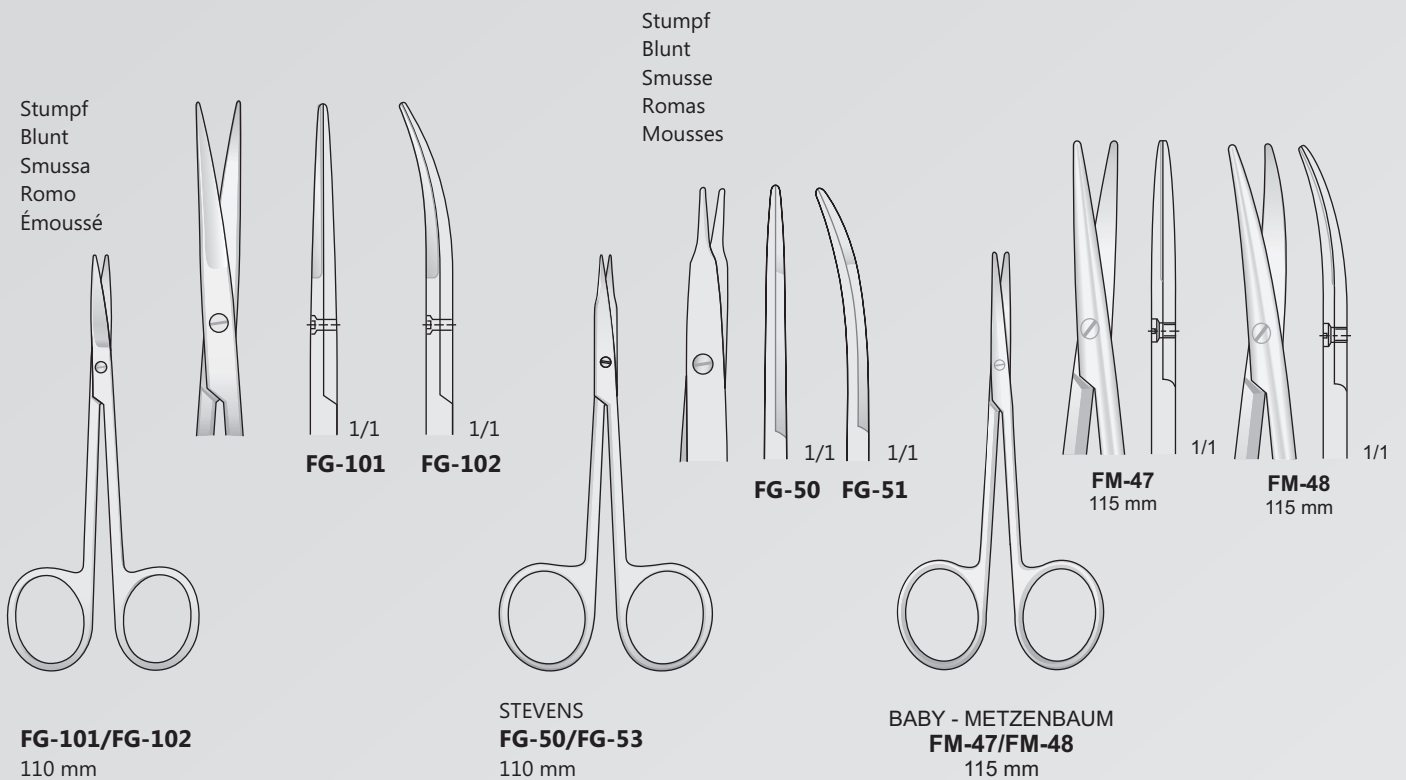
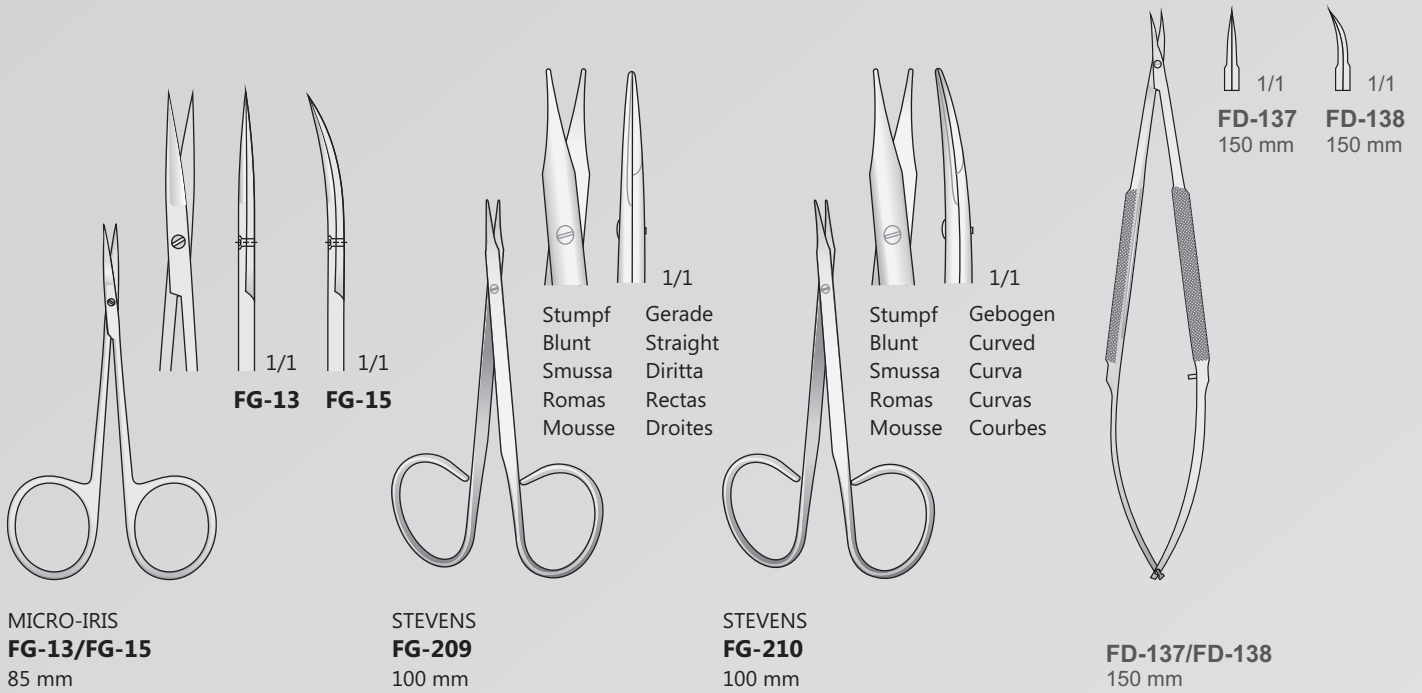

Glattes Maul
Smooth jaws
Morso liscio
Bocas lisas
Mors lisses

Micro Nadelhalter
Micro Needle Holders
Micro port'aghi
Micro portaagujas
Micro porte aiguilles

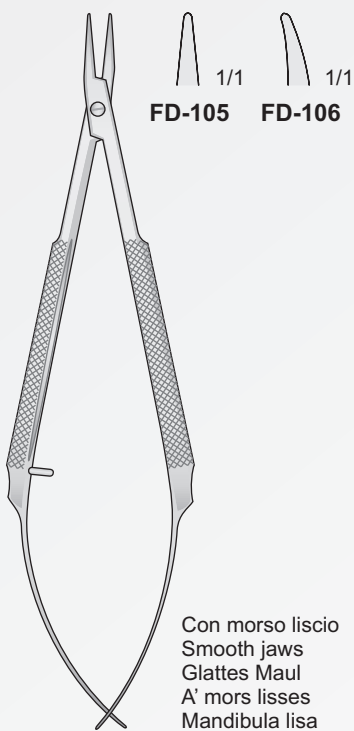

FD-105/FD-106
110 mm

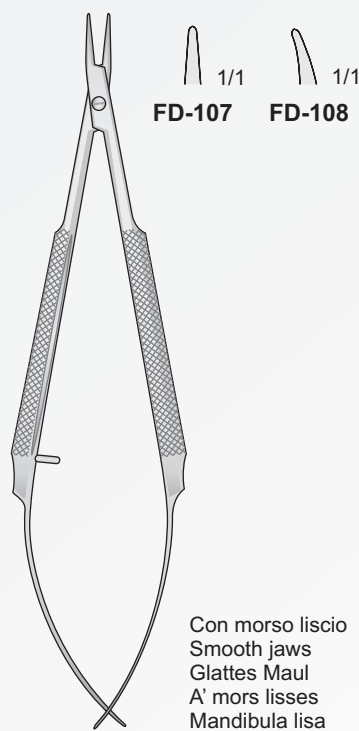

FD-107/FD-108
110 mm

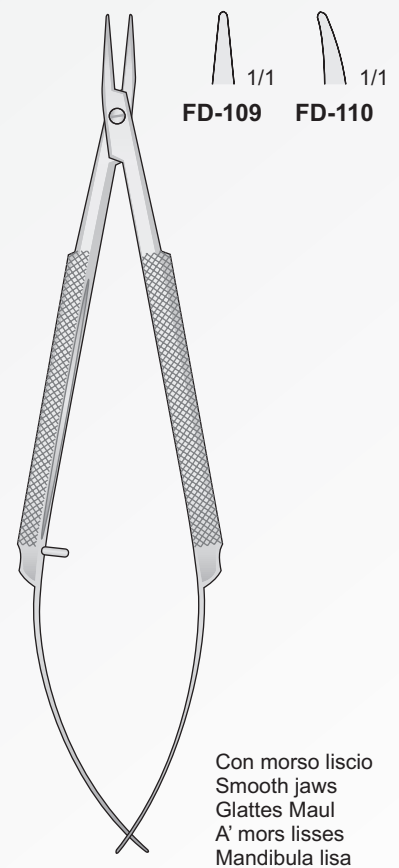

FD-109/FD-110
125 mm

| | |
|-----------------------|--------------|
| Micro Nadelhalter | Glattes Maul |
| Micro Needle Holders | Smooth jaws |
| Micro port'aghi | Morso liscio |
| Micro portaagujas | Bocas lisas |
| Micro porte aiguilles | Mors lisses |

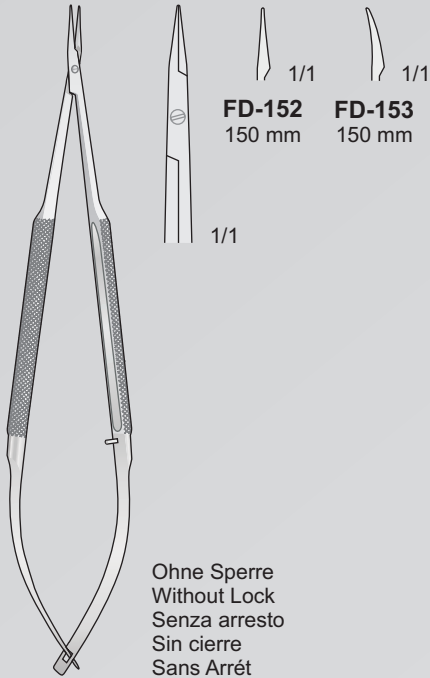

BARRAQUER
FD-152/FD-153
150 mm

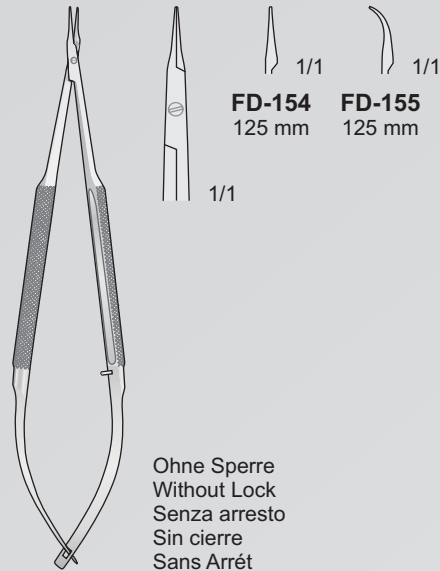

BARRAQUER
FD-154/FD-155
125 mm

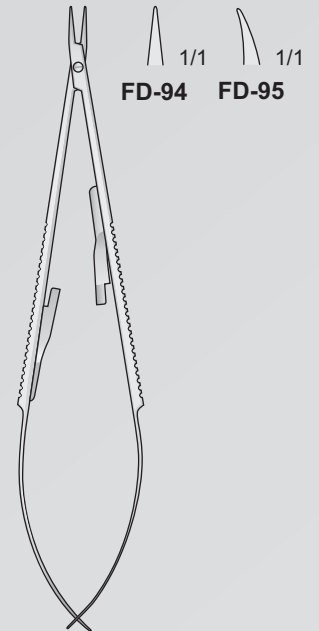

FD-94/FD-95
135 mm

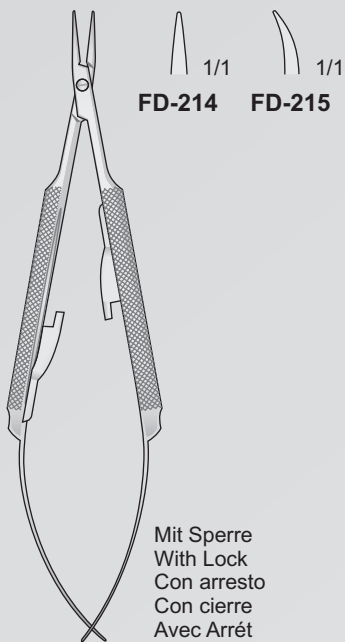

BARRAQUER
FD-214/FD-215
125 mm

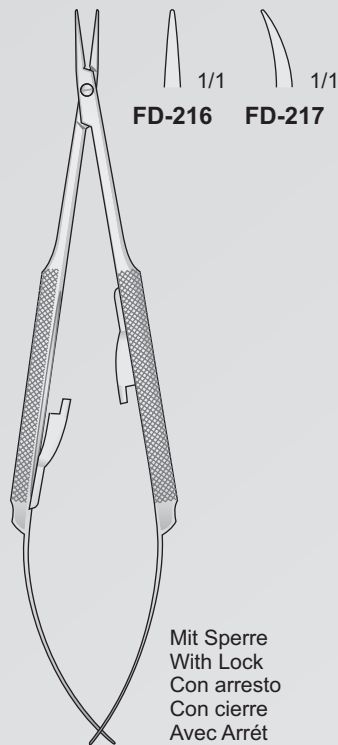

BARRAQUER
FD-216/FD-217
150 mm

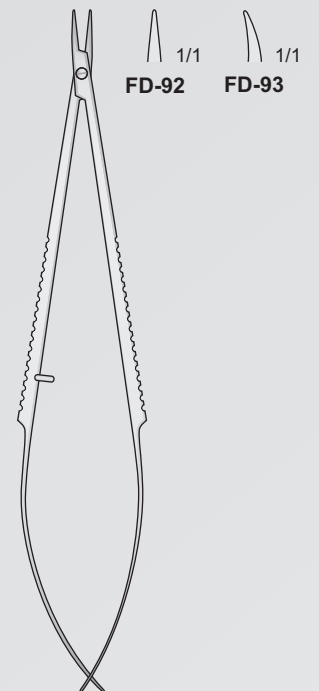

FD-92/FD-93
135 mm

Augeninstrumente
Eye instruments
Strumenti per oftalmologia
Instrumentos oculares
Instrumentes pour l'oftalmologie



ZIEGLER
NK-06/NK-10
115 mm

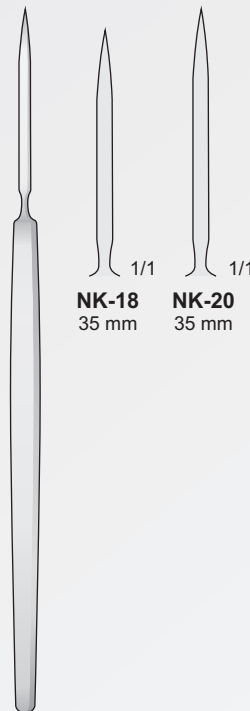

GRAEFE
NK-18/NK-20
140 mm



GRAEFE
NK-14/NK-16

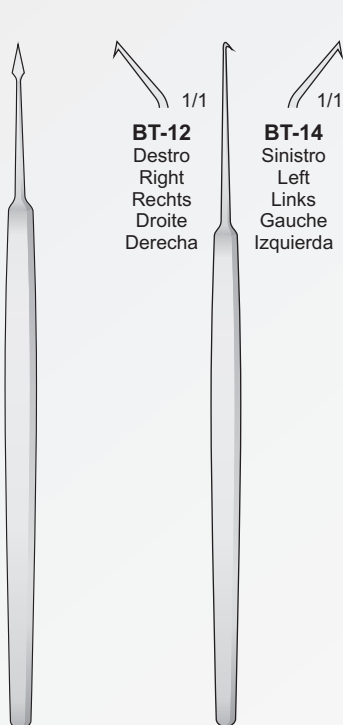

NK-49
125 mm

GRAEFE
BT-10
130 mm

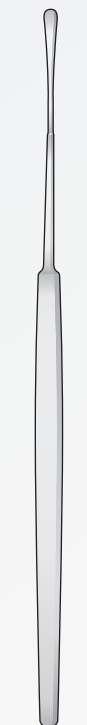

KIMURA
NK-48
150 mm

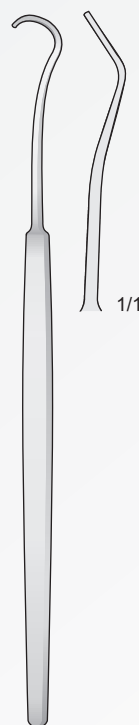

ARRUGA
NK-59
140 mm

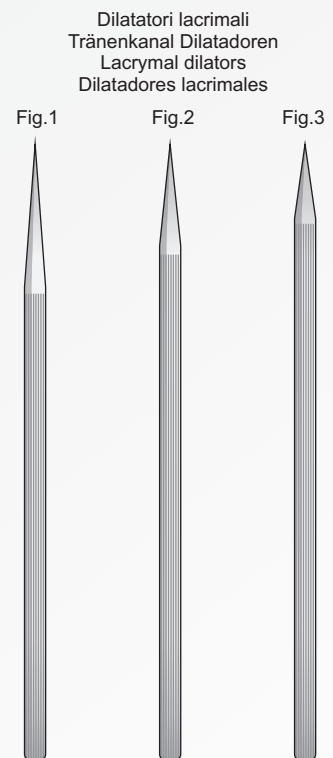

WILDER
NK-97
100 mm

WILDER
NK-98
100 mm

WILDER
NK-99
100 mm

Augeninstrumente
Eye instruments
Strumenti per oftalmologia
Instrumentos oculares
Instrumentes pour l'oftalmologie

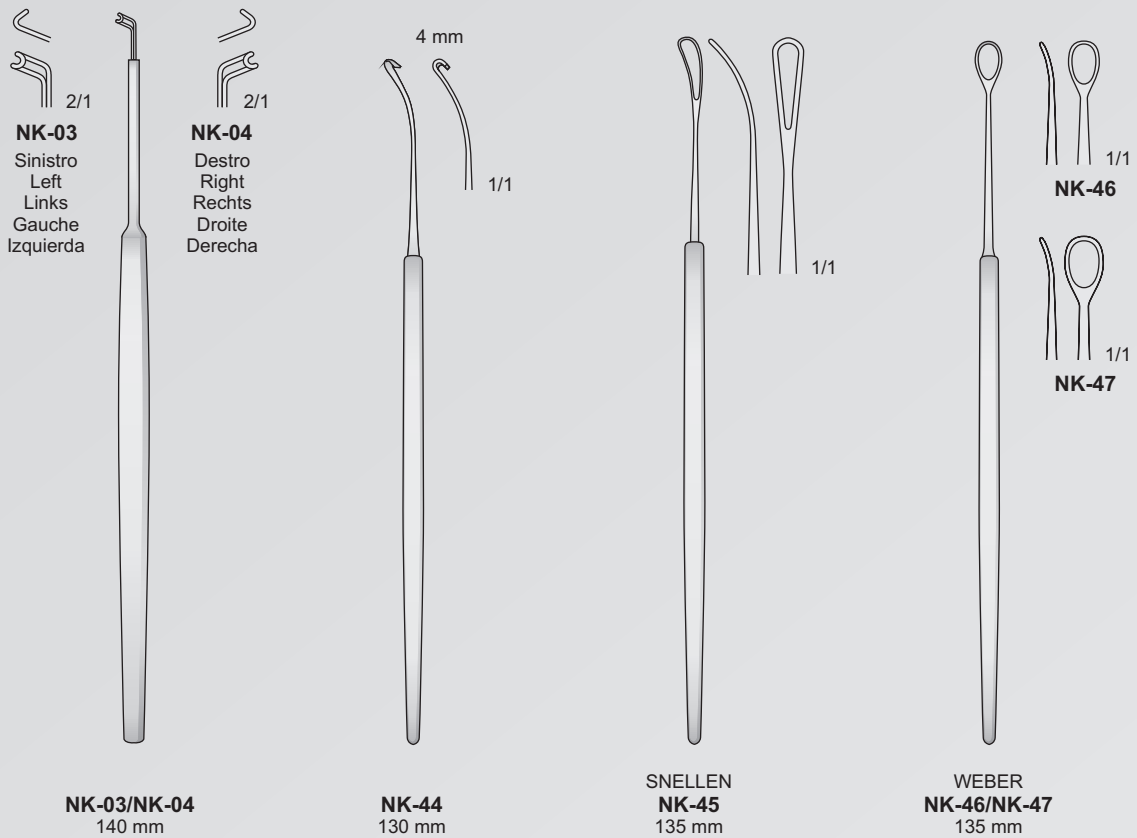
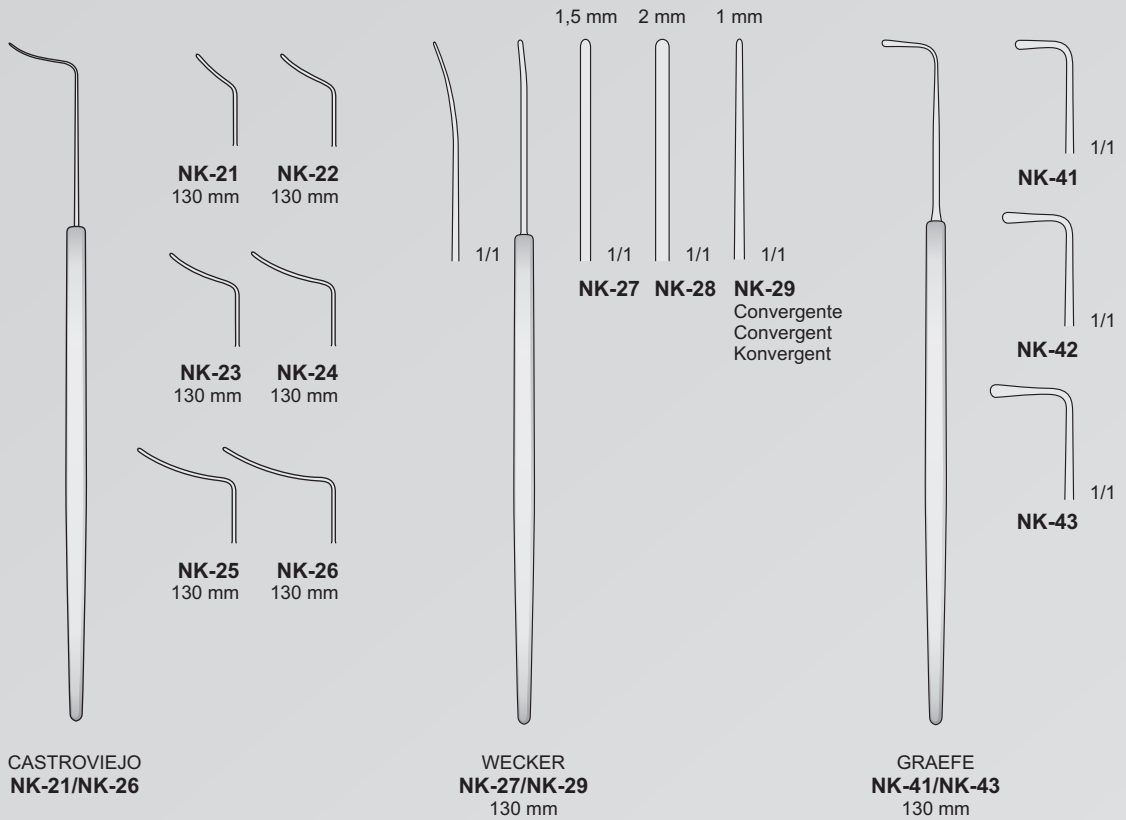

Augeninstrumente
Eye instruments
Strumenti per oftalmologia
Instrumentos oculares
Instrumentes pour l'oftalmologie

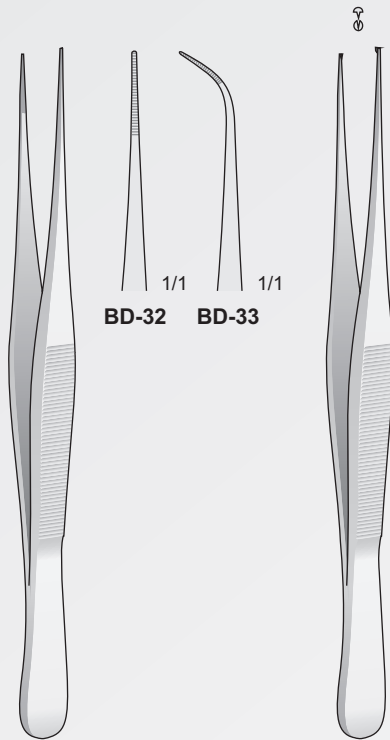

BD-32 BD-33
1/1 1/1

BD-32/BD-33
100 mm

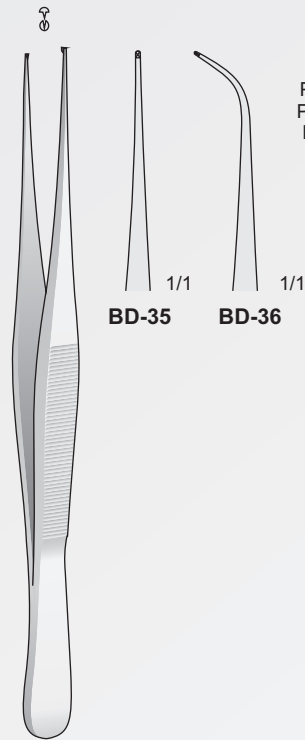

BD-35 BD-36
1/1 1/1

BD-35/BD-36
100 mm

Lidplatte
Lid Plate
Placca per palpebre
Placa para párpados
Plaque à paupières

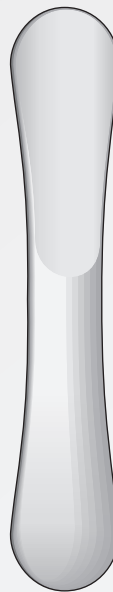

JAEGER
OM-09
110 mm

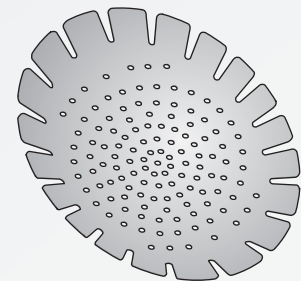

Okkluder Aluminium
Occluder Aluminium
Occlusore in Alluminio
Ocluser de aluminio
Obtuteur aluminium

OL-20
75 mm

Chalazionpinzetten
Chalazion Forceps
Pinzette da calazio
Pinzas para chalazion
Pincas à chalazion

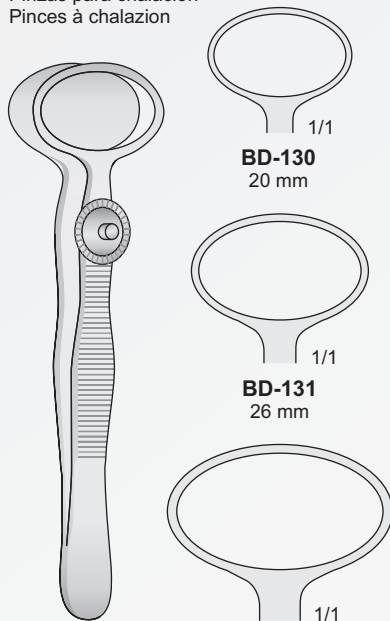

BD-130
20 mm

BD-131
26 mm

BD-132
31 mm

DESMARRES
BD-130/BD-132
90 mm



BD-56/BD-59
100 mm

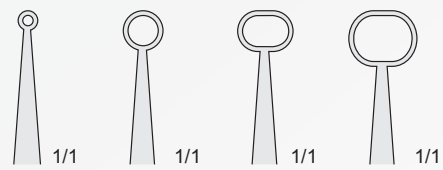

BD-56

BD-57

BD-58

BD-59

Pinzetten dritte Augenlid
Tweezers third eyelid
Pinza terza palpebra
Pinzas párpado tercero
Brucelles troisième paupière

Augeninstrumente
Eye instruments
Strumenti per oftalmologia
Instrumentos oculares
Instrumentes pour l'oftalmologie

Pinze da Fissazione-oftalmica - Fixier und fasspinzetten
Fixation and Grasping forceps - Pinzas de fijación y de aprehensión

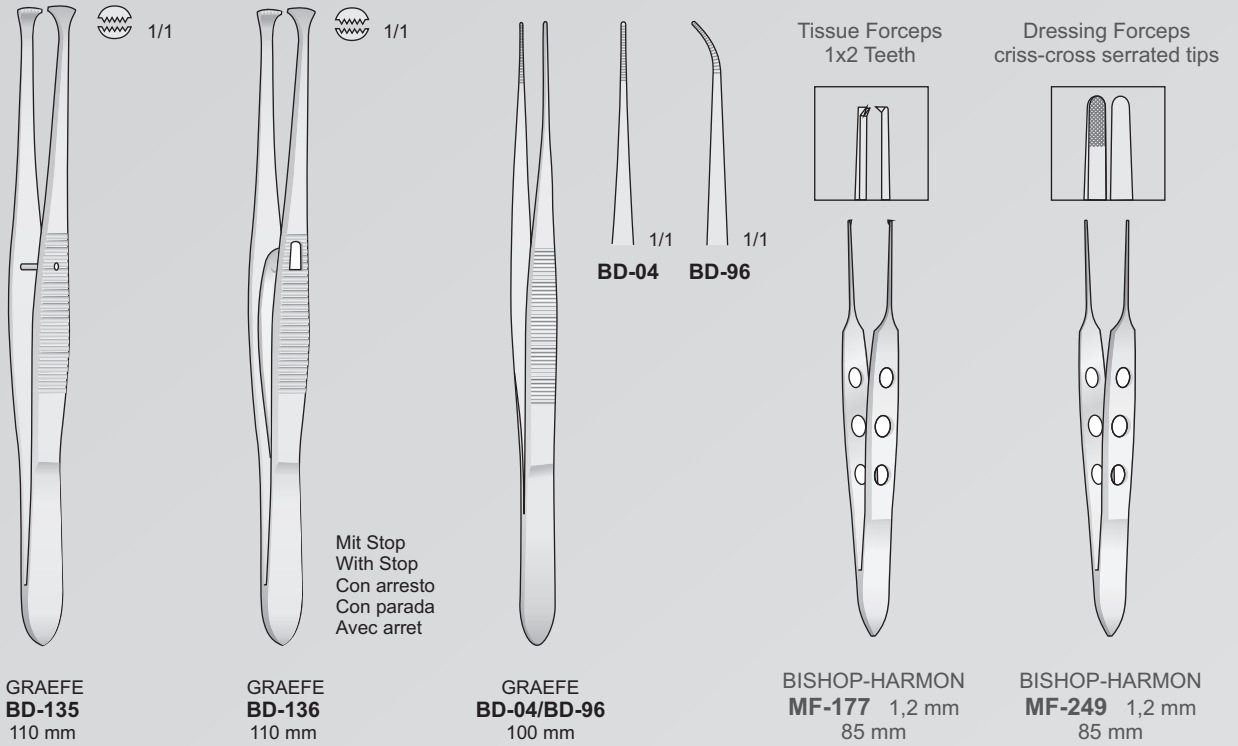

Micro Pinzette - Micro Forceps - Mikro Pinzetten - Micro pinces - Pinzas finas

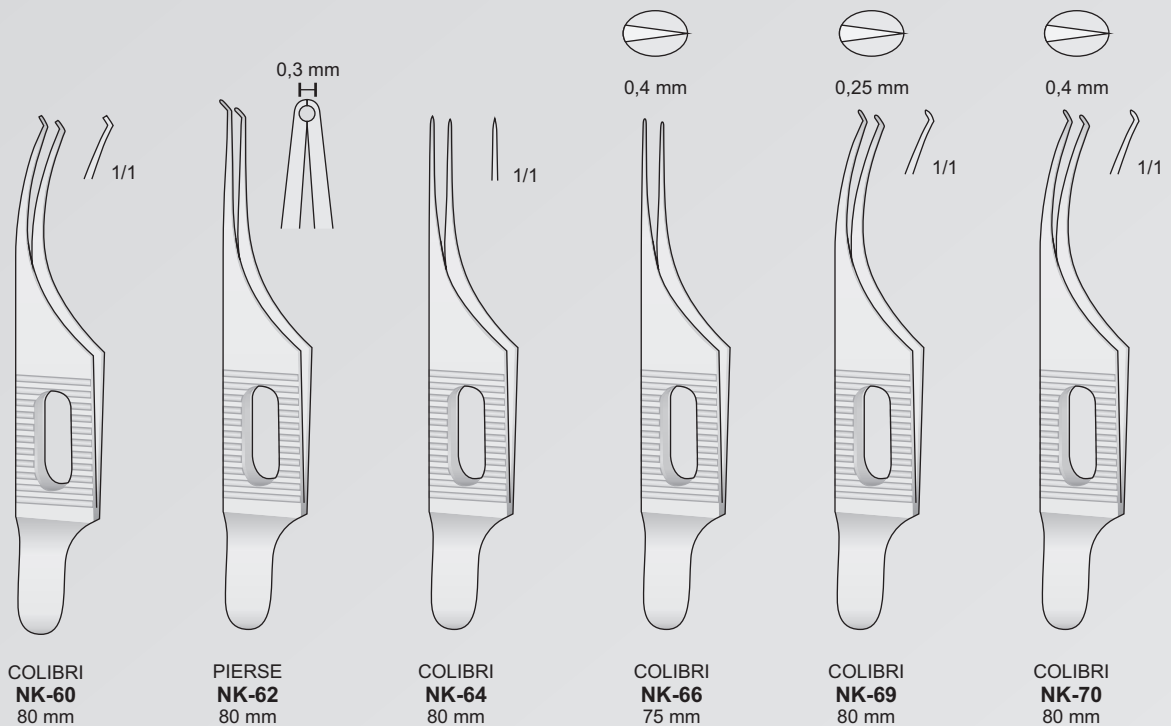

Corneal Fixation Forceps
1x1 Pierse teeth of 0.1 mm

Mit Fadenplatte
With tying platform
Con piano prendifilo
Con plataforma
Avec plateau pour monofil

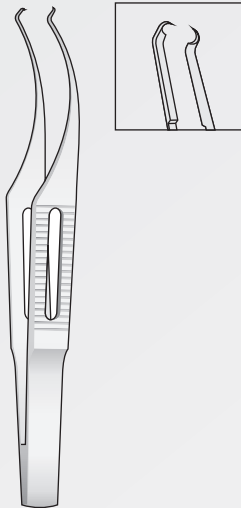

COLIBRI
MF-172
83 mm

Corneal Suturing Forceps
1x2 Teeth of 0.12 mm, 45°

Mit Fadenplatte
With tying platform
Con piano prendifilo
Con plataforma
Avec plateau pour monofil

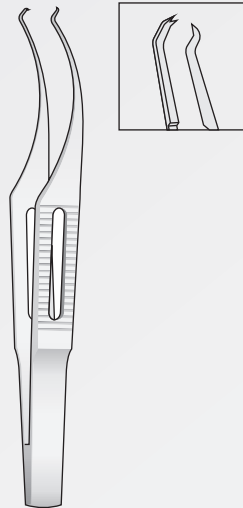

COLIBRI
MF-173
83 mm

Corneal Utility Forceps
1x2 teeth set at 90°, smooth

Ohne Fadenplatte
Jaws without platform
Senza piano prendifilo
Sin plataforma
Sans plateaux

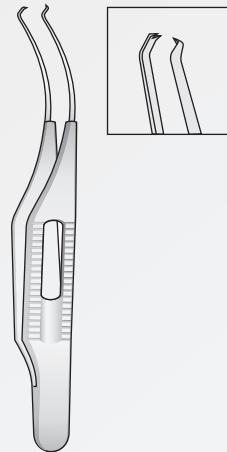

BARRAQUER
NK-401
75 mm

Corneal Suturing Forceps
1x2 teeth set at 90°, smooth

Mit Fadenplatte
With tying platform
Con piano prendifilo
Con plataforma
Avec plateau pour monofil

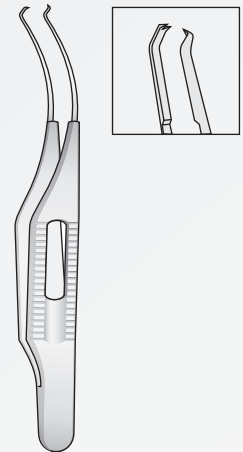

BARRAQUER
NK-403
75 mm

Pinzetta serrafili con solo
piano prendifilo fine
Tying Forceps
delicate 5 mm long platform
for 7-0 to 9-0 sutures

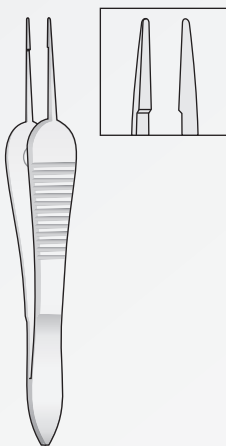

St.MARTIN
MF-200
85 mm

Tying & Utility Forceps
standard 7 mm long platform
for sutures below 7-0

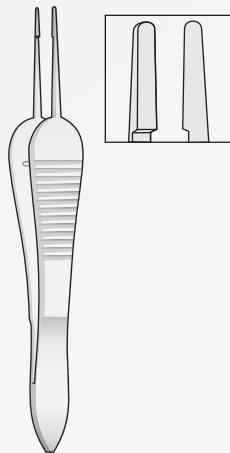

PAUFIQUE
MF-201
88 mm

Suturing Forceps
1x2 teeth of 0,3 mm set at 45°
with delicate platform

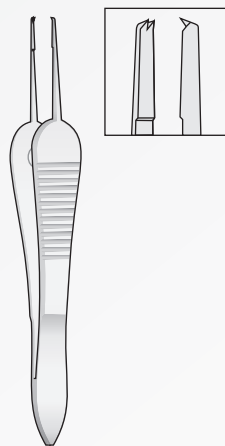

St.MARTIN
MF-205
85 mm

Allzweck Pinzette
mit Fadenplatte
Universal Suturing Forceps
1x2 teeth of 0,7 mm set at 45°
with heavy platform

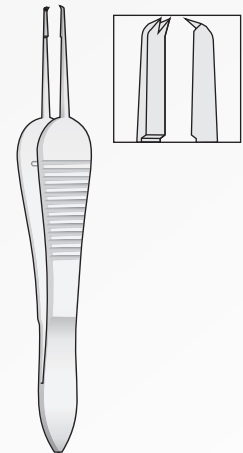

PAUFIQUE
MF-206
88 mm

Augeninstrumente
Eye instruments
Strumenti per oftalmologia
Instrumentos oculares
Instrumentes pour l'oftalmologie

Cilien Pinzetten
Cilia Forceps
Pinzette depilatorie
Pinzas depilatoria
Pincas à cils

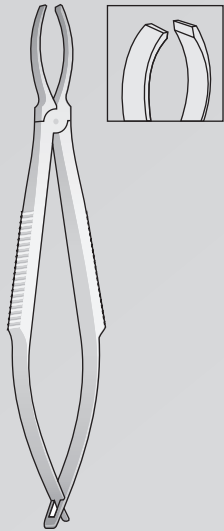

GRADLE
FD-131
95 mm

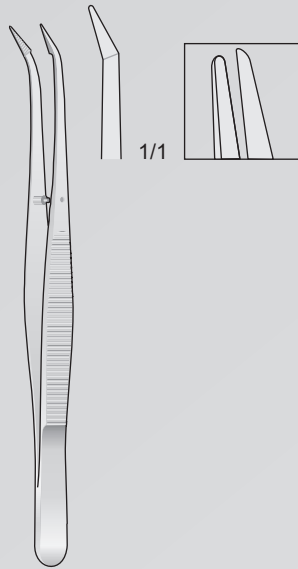

BARRAQUER
ES-65
105 mm

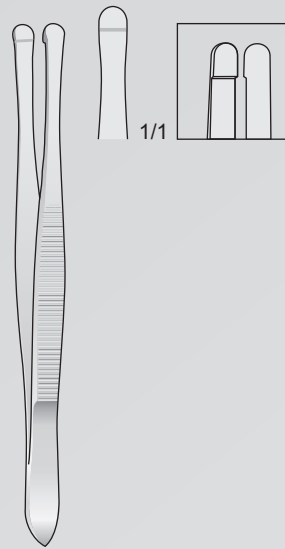

BEER
ES-48
90 mm

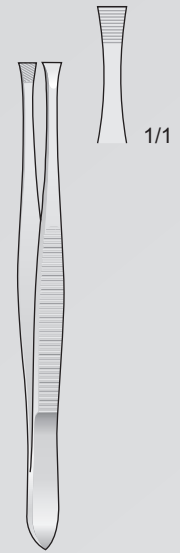

LITTAUER
ES-64
85 mm

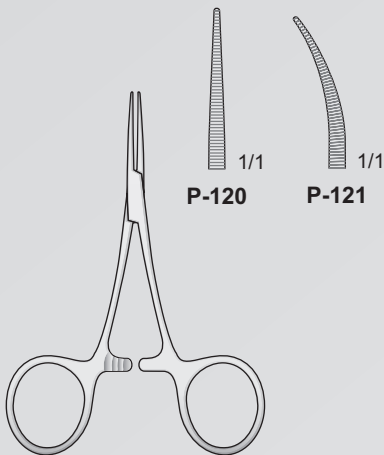

HARTMANN-BABY-MOSQUITO
P-120/P-121
95 mm

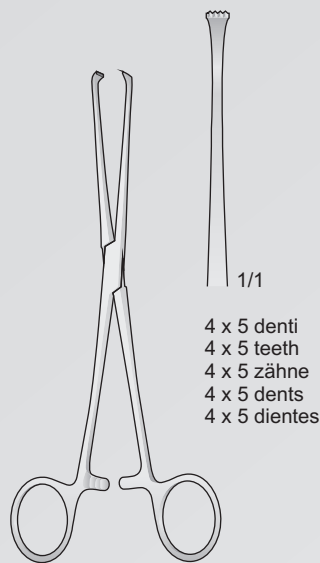

BABY-ALLIS
P-100
130 mm

4 x 5 denti
4 x 5 teeth
4 x 5 zähne
4 x 5 dents
4 x 5 dientes



BB-46
135 mm



LB-361
Conf. 10 pz.



LB-364
Conf. 10 pz.



LB-365
Conf. 10 pz.



LB-367
Conf. 10 pz.

Augeninstrumente
Eye instruments
Strumenti per oftalmologia
Instrumentos oculares
Instrumentes pour l'oftalmologie

Strumenti per aspirazione e lavaggio
Aspirating and Irrigating instruments
Saug- und Spülinstrumente
Instruments à aspiration et à irrigation
Instrumentos de aspiración y de lavado

Lagerungsgestell für 15 Stück Nadeln
Rack for 15 needles
Piastra per 15 aghi oftalmici
150 x 100 x 2 mm

Scala comparativa delle sonde per canale lacrimale

| | | | | | | |
|----------|------|-----|-----|-----|-----|-----|
| Fig. | 0000 | 000 | 00 | 0 | 1 | 2 |
| Ø in mm. | 0.5 | 0.6 | 0.7 | 0.8 | 0.9 | 1.1 |
| Fig. | 3 | 4 | 5 | 6 | 7 | 8 |
| Ø in mm. | 1.3 | 1.4 | 1.5 | 1.6 | 1.8 | 1.9 |



BOWMAN
PF-30 00/0 **PF-34** 5/6
PF-31 1/2 **PF-35** 7/8
PF-33 3/4 **PF-37** 6/7

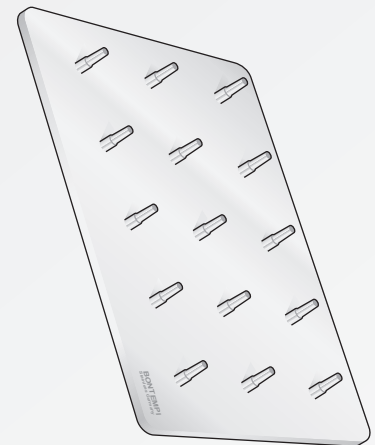
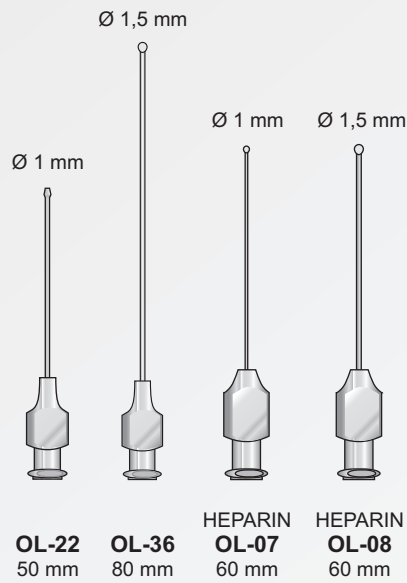

BS-20
150 x 100 x 2 mm

Spülkanülen
Irrigating cannulas
Cannule di irrigazione
Cánulas de irrigación
Canules d'irrigation

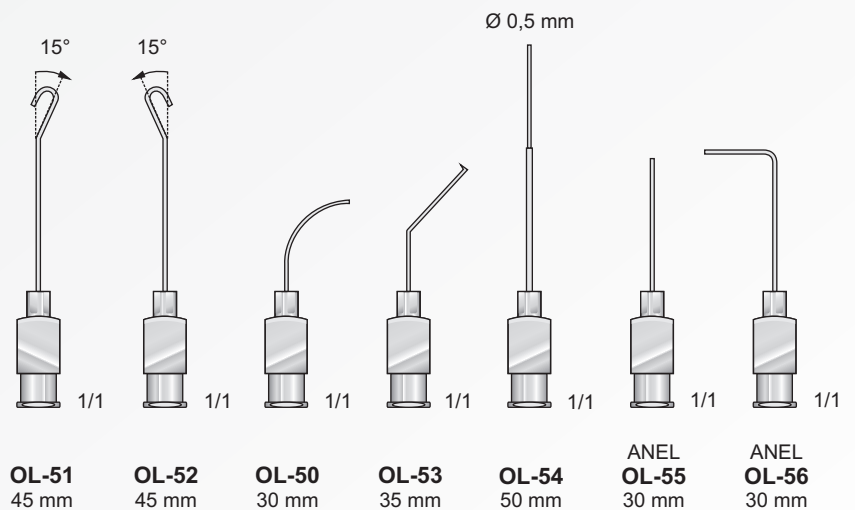

Messinstrumente
Measuring instruments
Strumenti per misura
Instrumentos para medir
Instruments à mesurer

Meßbereich: 0 - 15 mm
Measuring range: 0 - 15 mm
Campo di misura: 0 - 15 mm
Alcance de medición: 0 - 15 mm
Etendue de mesure: 0 - 15 mm

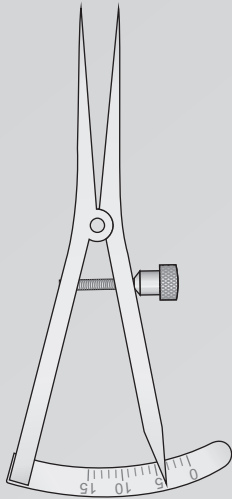

CASTROVIEJO
OR-15
90 mm

Meßbereich: 0 - 20 mm
Measuring range: 0 - 20 mm
Campo di misura: 0 - 20 mm
Alcance de medición: 0 - 20 mm
Etendue de mesure: 0 - 20 mm

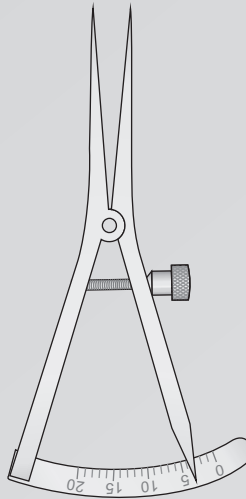

CASTROVIEJO
OR-17
90 mm

Meßbereich: 0 - 20 mm
Measuring range: 0 - 20 mm
Campo di misura: 0 - 20 mm
Alcance de medición: 0 - 20 mm
Etendue de mesure: 0 - 20 mm

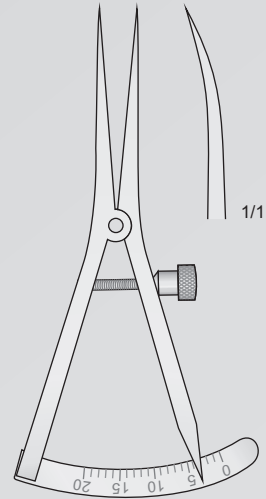

CASTROVIEJO
OR-19
90 mm

Meßbereich: 0 - 40 mm
Measuring range: 0 - 40 mm
Campo di misura: 0 - 40 mm
Alcance de medición: 0 - 40 mm
Etendue de mesure: 0 - 40 mm

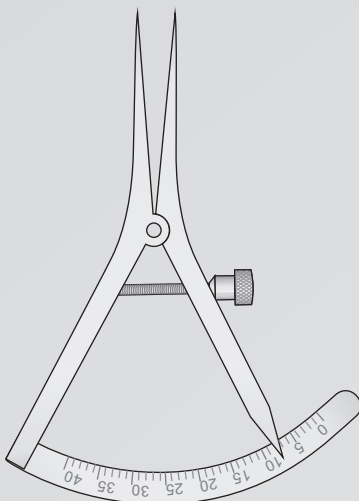

CASTROVIEJO
OR-11
90 mm

Meßbereich: 0 - 40 mm
Measuring range: 0 - 40 mm
Campo di misura: 0 - 40 mm
Alcance de medición: 0 - 40 mm
Etendue de mesure: 0 - 40 mm

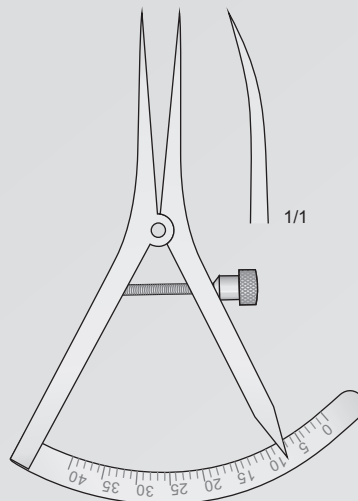

CASTROVIEJO
OR-13
90 mm

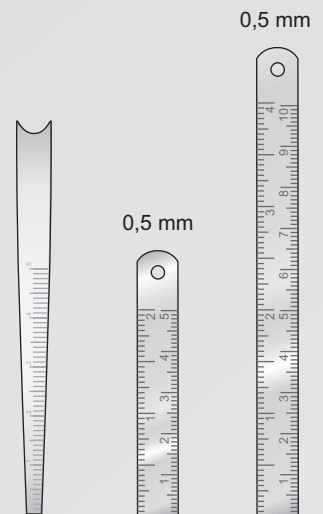

LS-04
80 mm

LS-07
50 mm

LS-08
100 mm

Lidsperrer, Wundsperrer
Eye Speculums, Retractors
Blefarostati, Divaricatori
Blefarostatos, Separador
Blépharostats, Ecarteurs

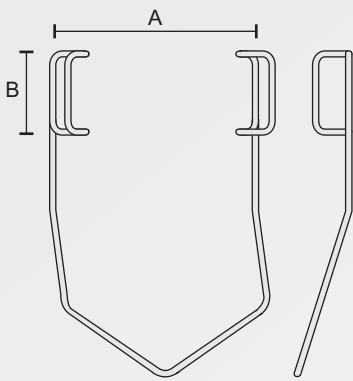

A B
NK-79 27 mm 11 mm
BARRAQUER

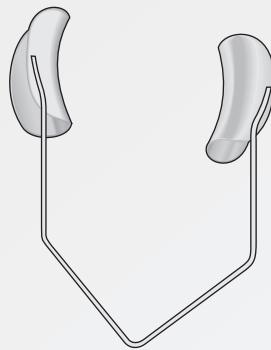

BARRAQUER
NK-83

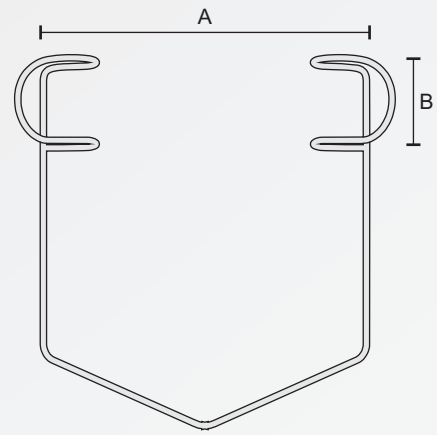

A B
NK-80 27 mm 5 mm
NK-82 34 mm 9 mm
NK-84 42 mm 12 mm
NK-86 42 mm 14 mm
BARRAQUER

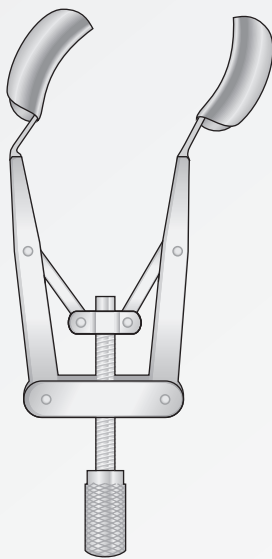

KERSHNER
NK-420

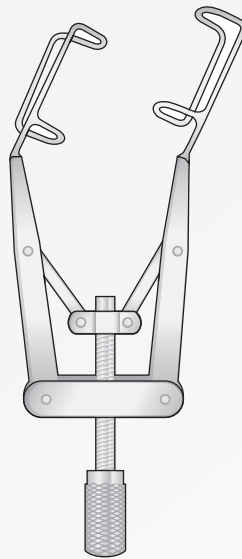

KERSHNER
NK-421

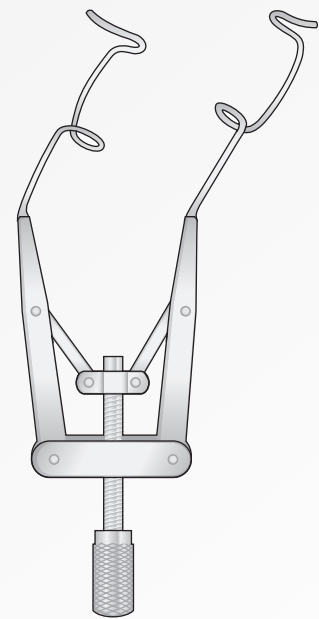

LIEBERMANN-TENNANT
NK-422

Lidsperrer
Eye Speculums
Blefarostati
Blefarostatos
Blépharostats

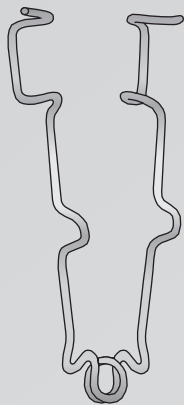

BOWMANN
NK-106
70 mm

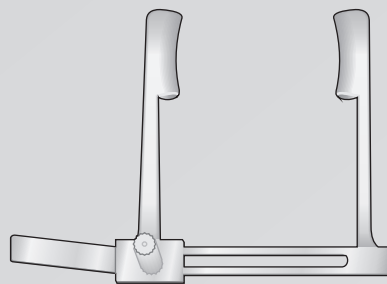

PROST
NK-92

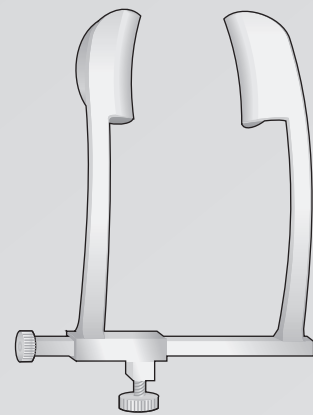

COOK
NK-131

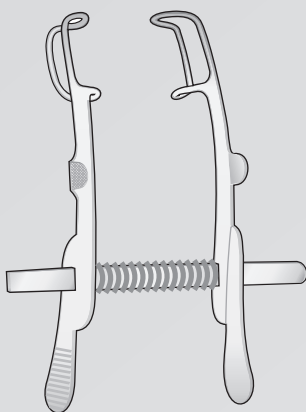

MELLINGER
BV-02
70 mm

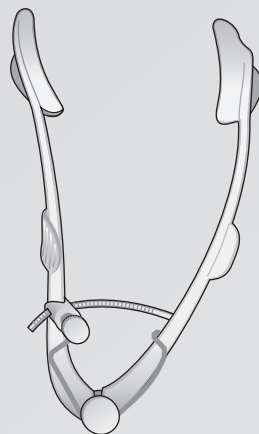

LISTER-BURCH
BV-04
80 mm

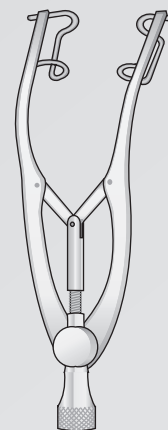

CASTROVIEJO
BV-05
80 mm

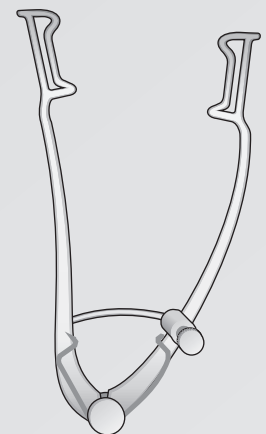

WILLIAMS
BV-06
80 mm

Set für Augenheilkunde
Set for Ophthalmology
Set per Oftalmologia
Set para Oftalmología
Fixée pour Ophtalmologie

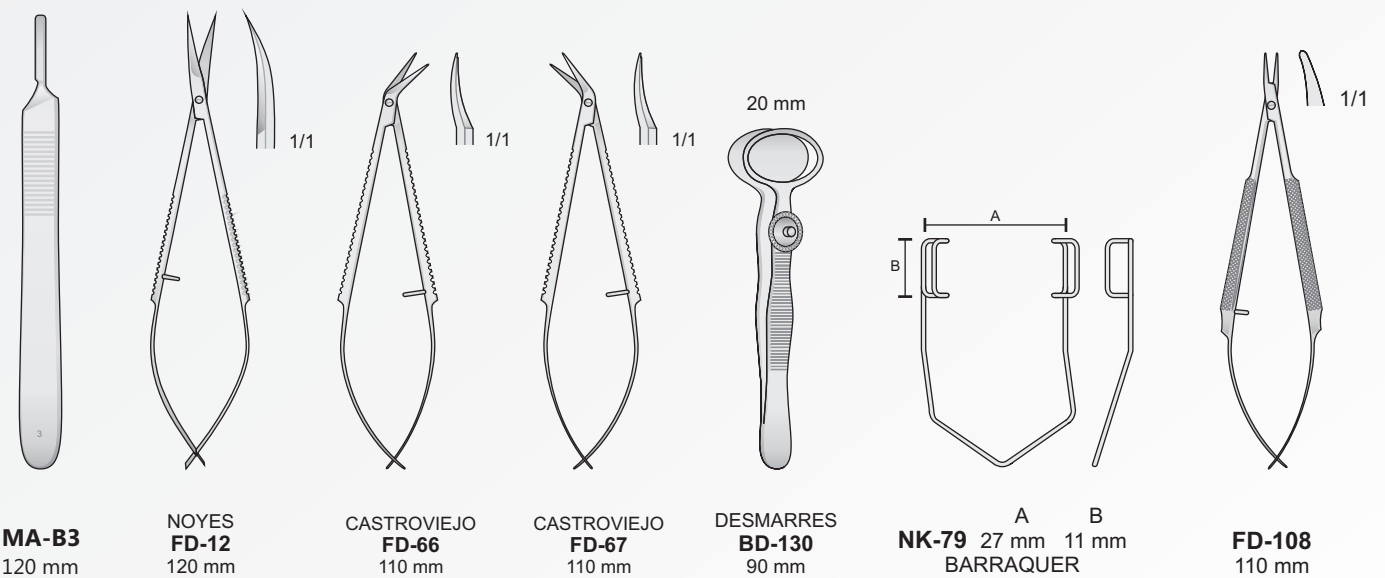
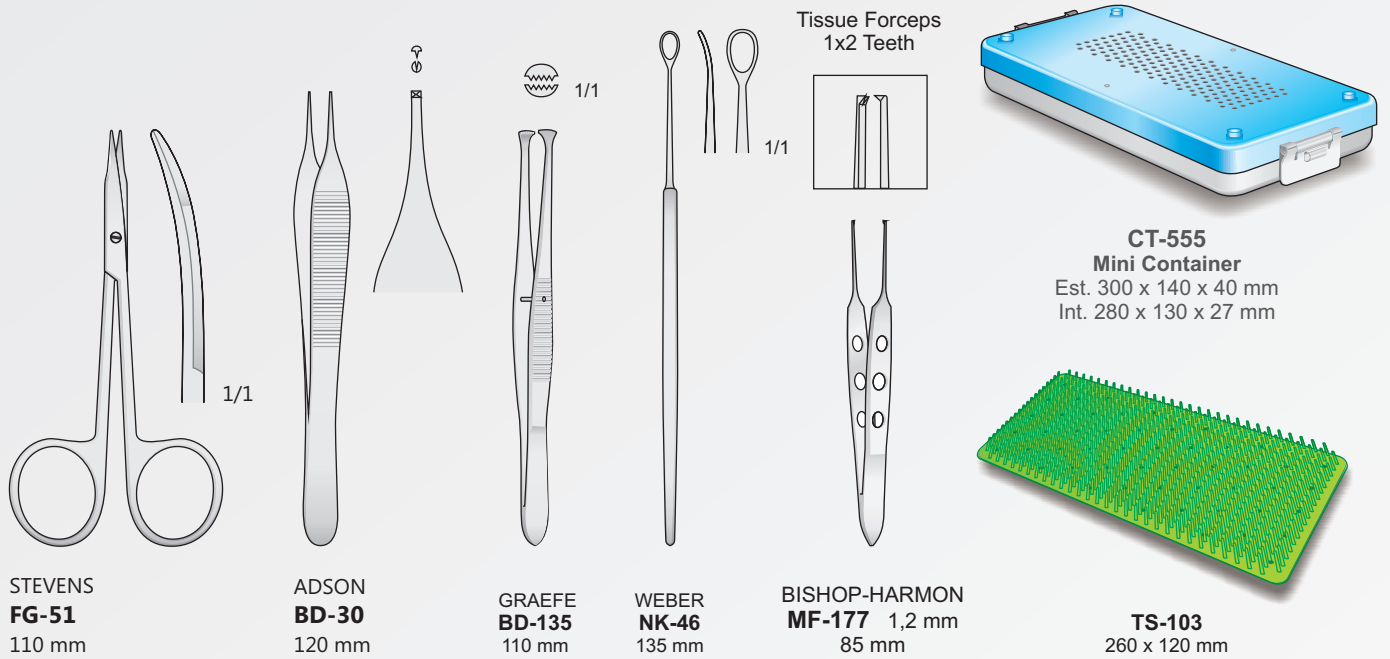



BONTEMPI
CHIRURGISCHE INSTRUMENTE

Sonden, Entdeckern, Watterträger und Absaugkanülen
Probes, Directors, Cotton Applicators, Suctions tubes
Sonde, Specilli, Porta cotone e Cannule per aspirazione
Sondas, Estiletos, Portaalgodón, Cànulas aspiradoras
Sondes, Stylets, Porte coton, Canules aspiratrices

Sonden
Probes
Sonde bottonute
Estiletos
Sondes

Ø 1 mm Ø 1,5 mm Ø 2 mm Ø 2 mm Ø 1,5 mm Ø 1,0 mm



Tränenkanal-Sonden
Lachrymal Probes
Sonde per canale lacrimale
Estiletos para canal lacrimal
Stylets pour canal lacrimal

Silber
Silver
Argento
Plata
Argent

| | | | | | | | |
|---------------------|---------------------|---------------------|---------------------|--------------------|--------------------------------------|------------------------------------|------------------|
| PF-20 145 mm | PF-32 130 mm | PF-27 145 mm | PF-36 130 mm | PF-7 145 mm | STACKE PF-14 110 mm | BOWMAN PF-30 00/0 | PF-34 5/6 |
| PF-21 160 mm | PF-22 145 mm | PF-23 160 mm | PF-15 145 mm | | | PF-31 1/2 | PF-35 7/8 |
| | PF-25 160 mm | PF-28 200 mm | PF-29 160 mm | | | PF-33 3/4 | PF-37 6/7 |
| | PF-26 200 mm | PF-44 250 mm | PF-38 200 mm | | | | |

Fistelsonden - Fistula probes - Sonde per fistole
Sondas para fistulas - Sondes pour fistules

Hohlsonde



| | | | | | | |
|--|--|--|--|--|--|--|
| LOCHART PF-80 170 mm | LOCHART PF-82 170 mm | LOCHART PF-83 170 mm | PF-54 145 mm PF-55 160 mm PF-19 180 mm PF-56 200 mm | PF-53 130 mm PF-57 145 mm PF-58 160 mm PF-59 180 mm | DOYEN PF-24 145 mm | NELATON PF-17 160 mm |
|--|--|--|--|--|--|--|

Wasserträger
Cotton applicators
Porta cotone
Portaalgodòn
Porte cotons

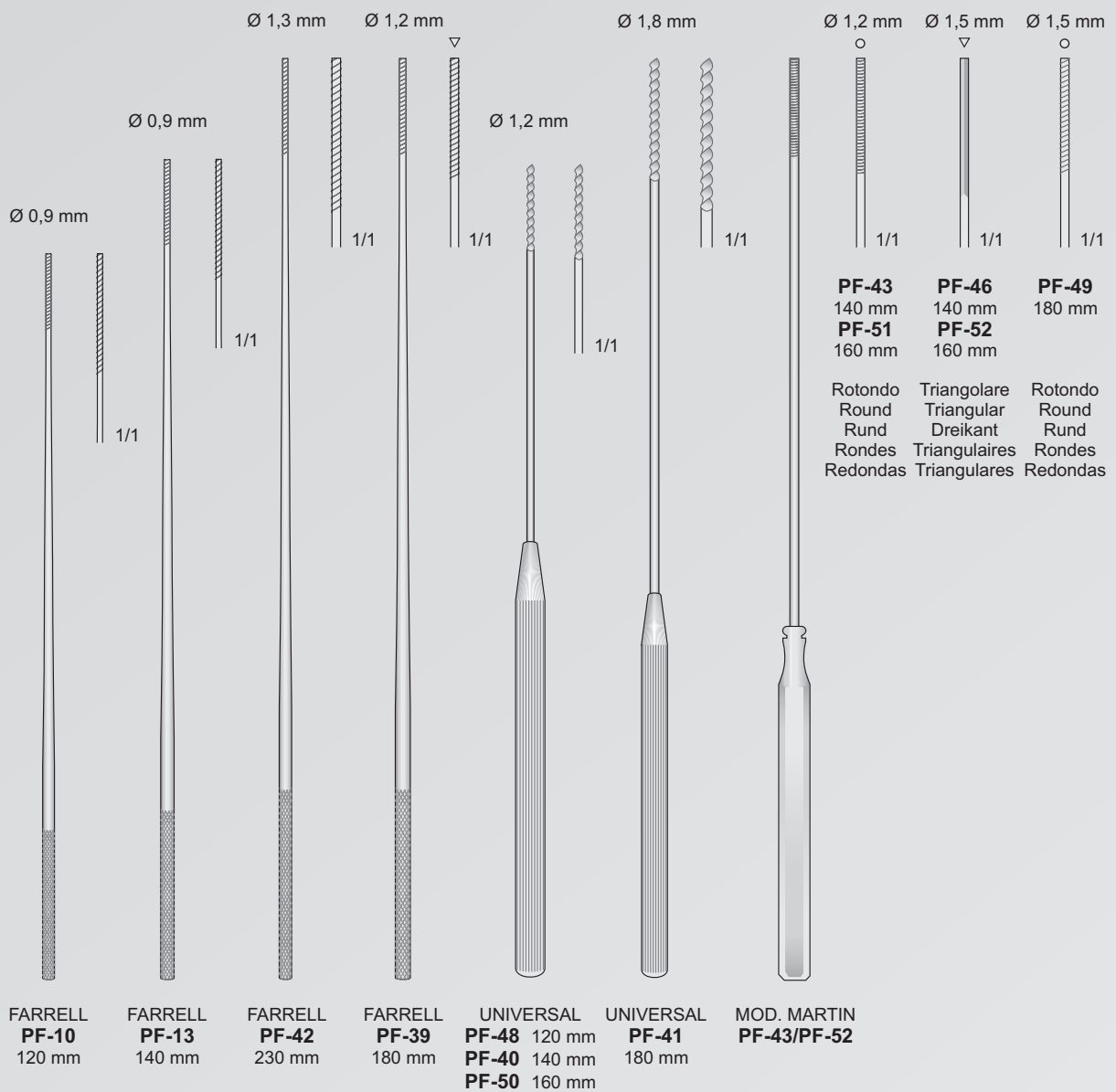

Spülkanülen
Irrigation Cannulae
Cannule per irrigazione
Cànulas para irrigación
Canules d'irrigation

Absaugkanülen
Suctions tubes
Cannule per aspirazione
Cànulas aspiradoras
Canules aspiratrices

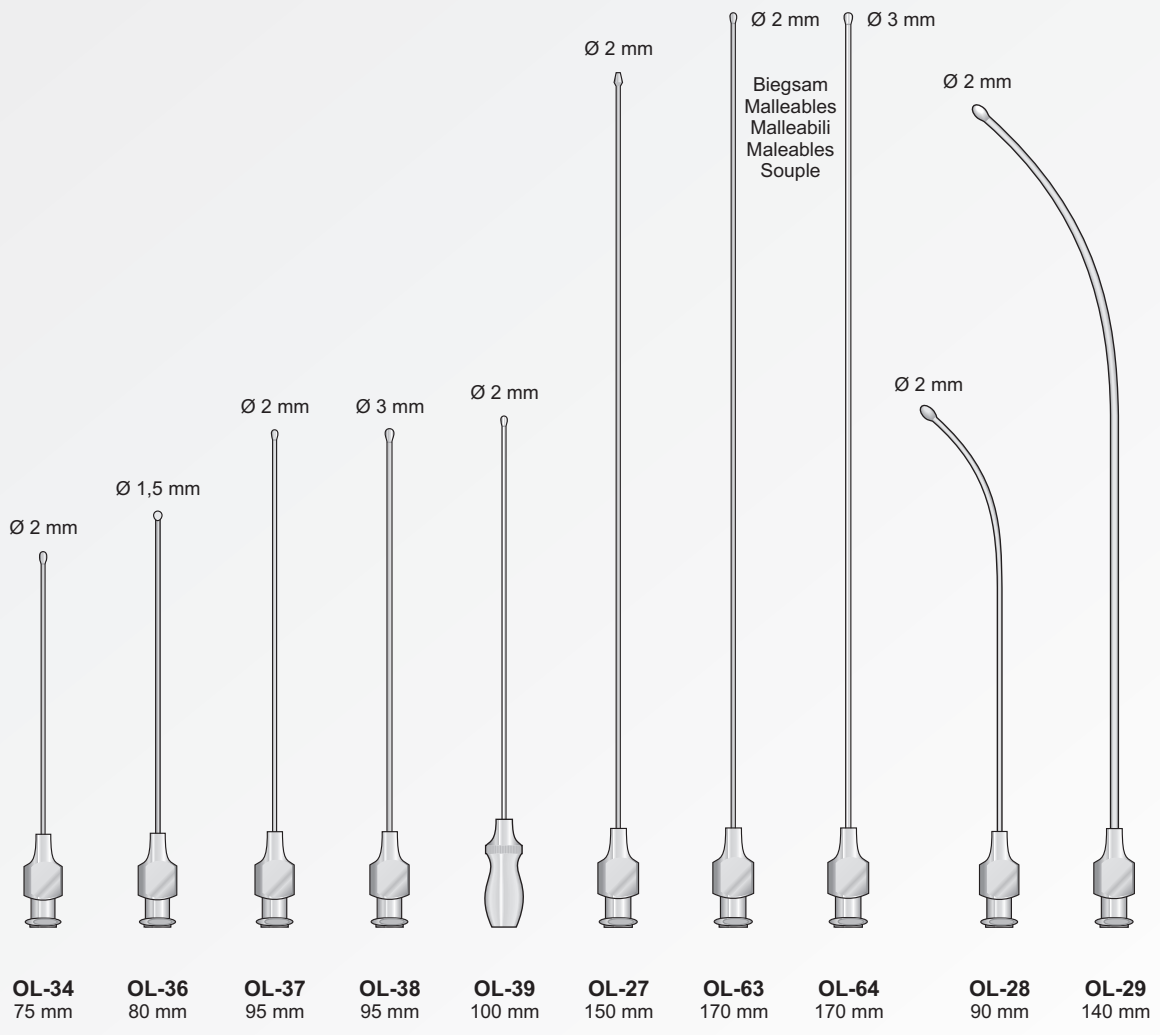
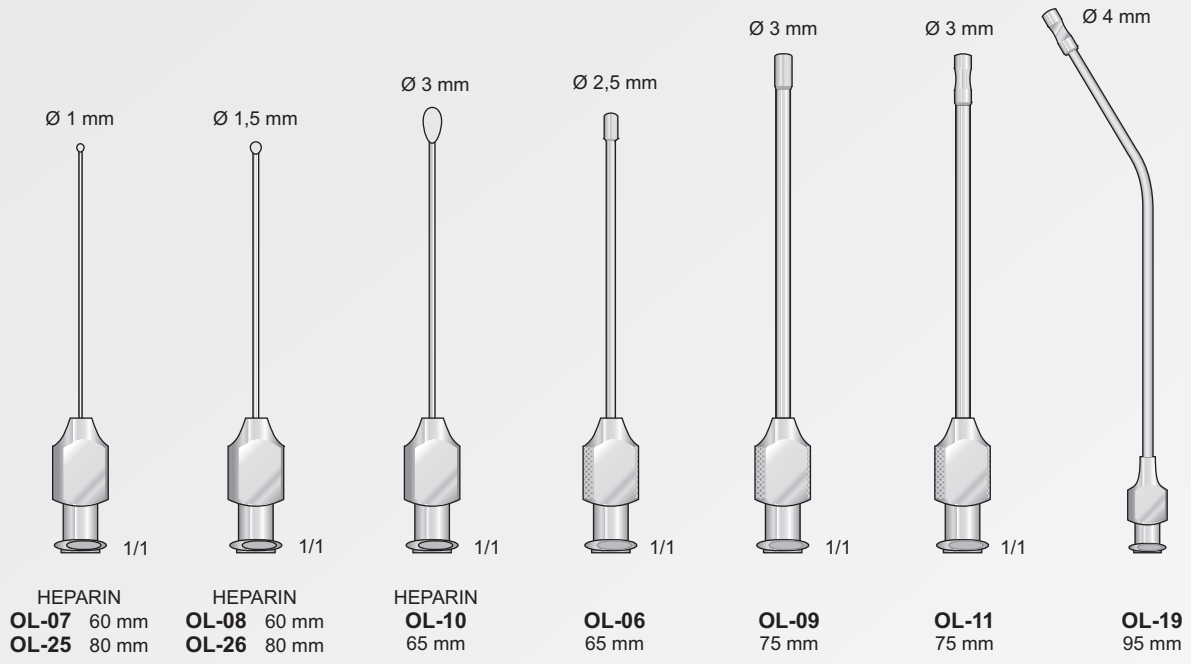

| | |
|-------------------------|-------------------------|
| Absaugkanülen | Spülkanülen |
| Suctions tubes | Irrigation Cannulae |
| Cannule per aspirazione | Cannule per irrigazione |
| Cànulas aspiradoras | Cànulas para irrigaciòn |
| Canules aspiratrices | Canules d'irrigation |

Saug- und Spülinstrumente
Aspirating and Irrigating instruments
Strumenti per aspirazione e lavaggio
Instrumentos de aspiraciòn y de lavado
Instruments à aspiration et à irrigation

Ø 1 mm



OL-22
50 mm

Ø 2 mm



OL-23
50 mm

Ø 3 mm

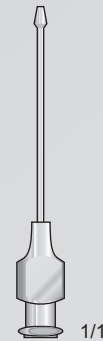

OL-24
50 mm

WULLSTEIN Spül- und Saughandgriff mit Luer-Konus,
passend für WULLSTEIN Spül- oder Saugrohre
WULLSTEIN Irrigating suction handle, with Luer cone,
for WULLSTEIN irrigating or Suction tubes
WULLSTEIN manico per aspirazione e lavaggio, con cono Luer,
per cannule per aspirazione e lavaggio di WULLSTEIN
WULLSTEIN mango irrigador y ispirador, con cono Luer, apropiado
para los tubos de lavado y de aspiraciòn según WULLSTEIN
WULLSTEIN manche aspirateur et irrigateur, à cône Luer, s'adaptant
aux tubes aspirateurs/irrigateurs de WULLSTEIN

Gefäß-spülkanülen, biegsam
Vessel irrigating cannulas, malleable
Cannule per irrigazione dei vasi, malleabili
Cànulas de irrigacion para vasos, maleables
Canules d'irrigation pour vaisseaux, malléables

Mit LUER-LOCK-Ansatz
With LUER-LOCK attachment
Con cono LUER-LOCK
Con cono LUER-LOCK
Avec cône LUER-LOCK

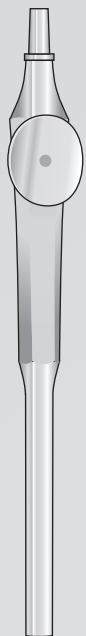

WULLSTEIN
GF-64
120 mm



GF-66
110 mm



GF-62
65 mm



ROSEN
OL-16 Ø 0,70 mm
OL-17 Ø 0,90 mm
OL-18 Ø 1,25 mm
95 mm



ROSEN
OL-13 Ø 0,70 mm
OL-14 Ø 0,90 mm
OL-15 Ø 1,25 mm
95 mm

Ø 3 mm



SCHMID
OL-30
150 mm

Ø 4 mm



SCHMID
OL-31
150 mm

Ø 5 mm



SCHMID
OL-32
150 mm

Ø 6 mm



SCHMID
OL-33
150 mm

Absaugkanülen
Suctions tubes
Cannule per aspirazione
Cánulas aspiradoras
Canules aspiratrices

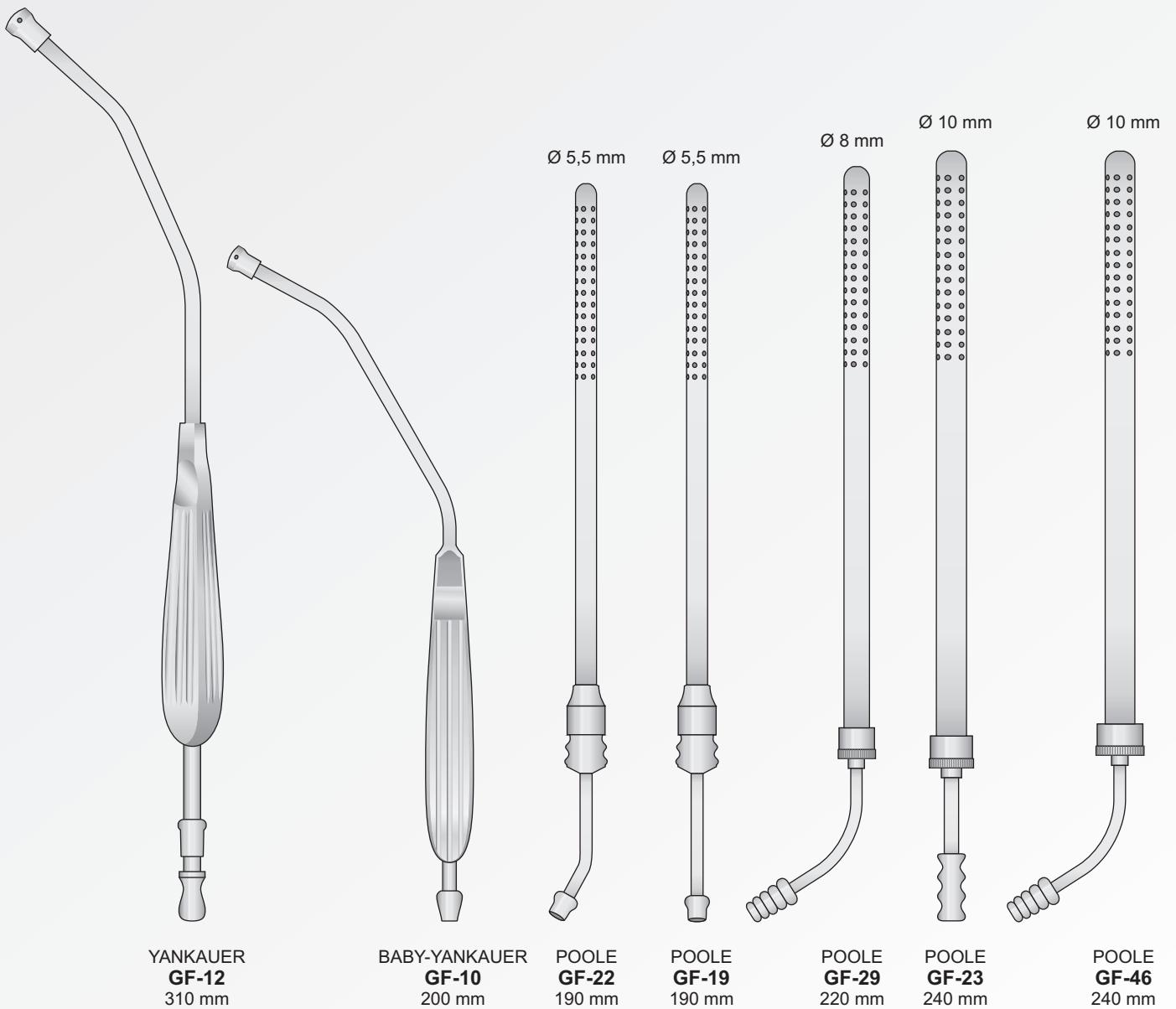

Absaugkanülen
Suctions tubes
Cannule per aspirazione
Cánulas aspiradoras
Canules aspiratrices

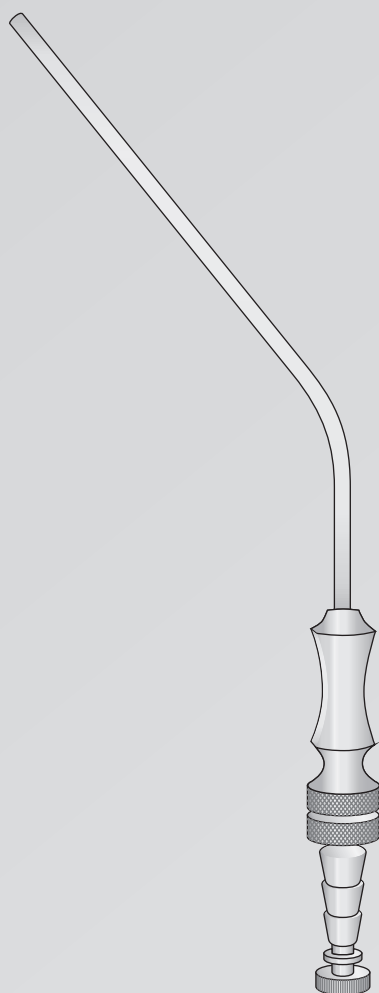

FRAZIER

GF-240 Ch. 6 2,0 mm
GF-241 Ch. 7 2,5 mm
GF-241B Ch. 8 2,7 mm
GF-242 Ch. 9 3,0 mm
GF-242B Ch. 10 3,3 mm
GF-243 Ch. 12 4,0 mm
GF-244 Ch. 15 5,0 mm
 180 mm



ADSON

GF-41 ch. 12 = Ø 4 mm
GF-42 ch. 15 = Ø 5 mm
 210 mm

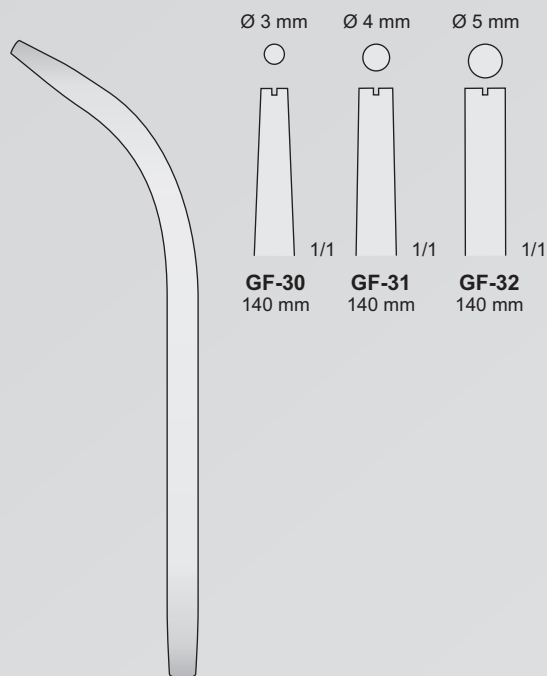

Ø 3 mm

Ø 4 mm

Ø 5 mm



GF-30
140 mm



GF-31
140 mm



GF-32
140 mm

GF-30/GF-32
140 mm

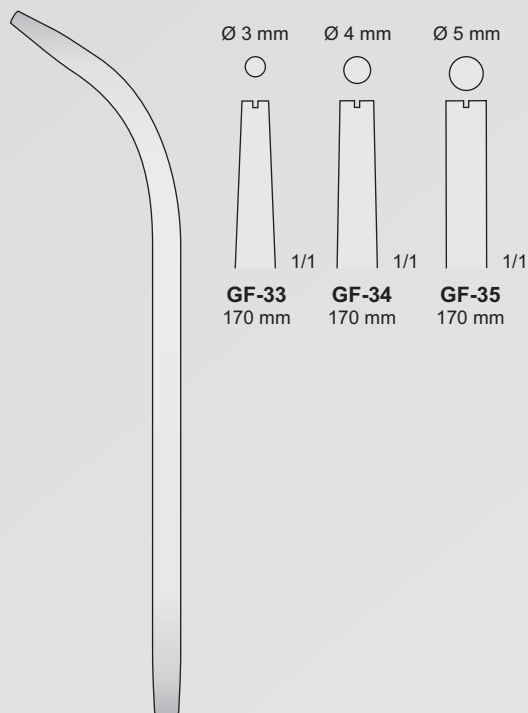

Ø 3 mm

Ø 4 mm

Ø 5 mm



GF-33
170 mm



GF-34
170 mm



GF-35
170 mm

GF-33/GF-35
170 mm

Absaugkanülen
Suctions tubes
Cannule per aspirazione
Cánulas aspiradoras
Canules aspiratrices

Tubo per aspirazione
Suction tube
Saugrohr
Tube d'aspiration

Tubo per irrigazione
Irrigation tube
Spülrohr
Tube d'irrigation

Char. 3 = 1 mm
Char 5 = 1,7 mm
Char 7 = 2,5 mm
Char 10 = 3,3 mm
Char 12 = 4 mm
Char 14 = 4,6 mm

Char. 2 = 0,6 mm
Char 4 = 1,21 mm
Char 5 = 1,7 mm
Char 7 = 2,5 mm
Char 8 = 2,4 mm
Char 12 = 4 mm

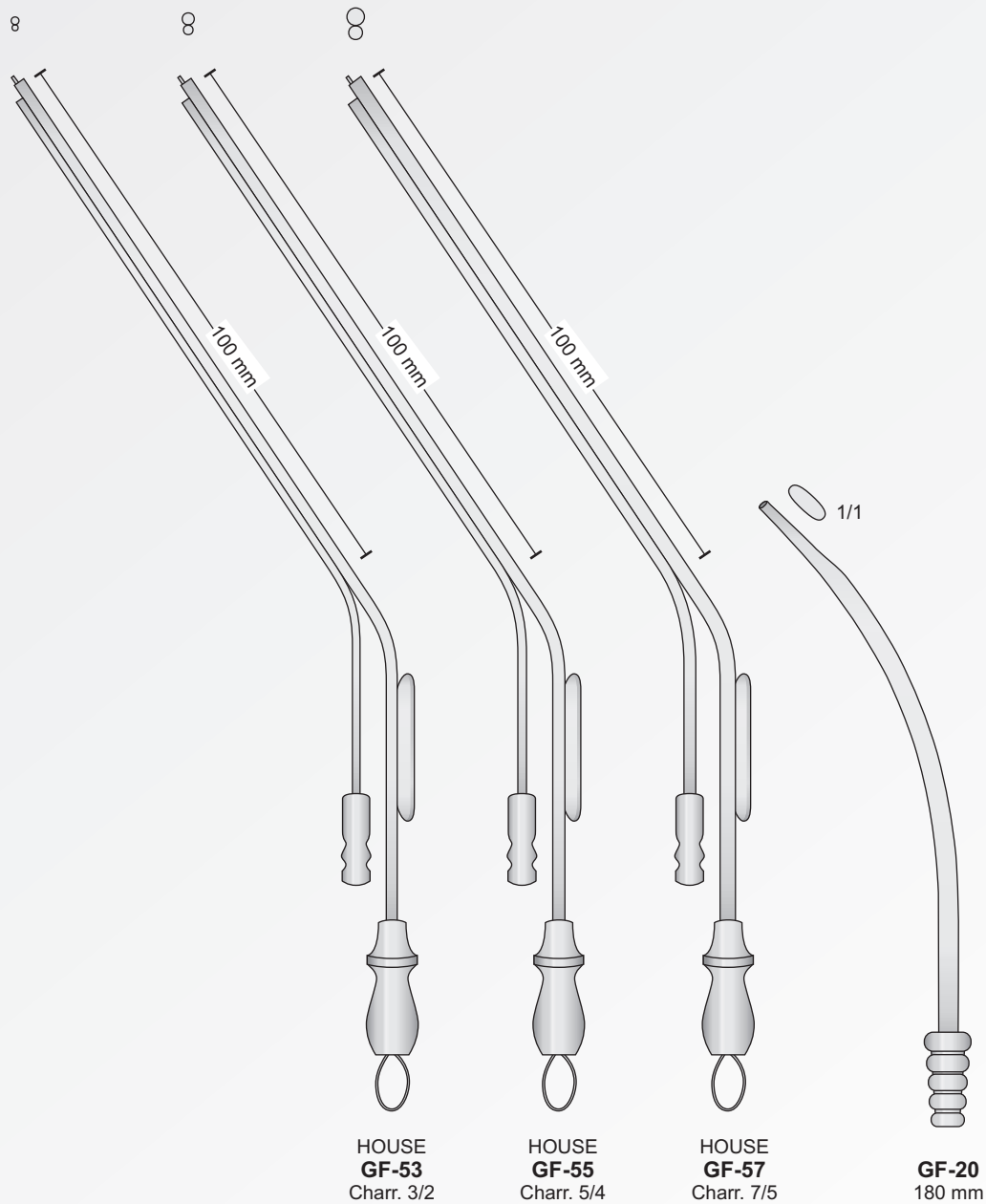



BONTEMPI
CHIRURGISCHE INSTRUMENTE

Urologie, Gynäkologie
Urology, Gynecology
Urologia e Ginecologia
Urologia, Ginecologia
Urologie, Gynécologie

Rektal und Vaginal-Spekula für Kleintiere
Specula for small animals for Vaginal and Rectal Examination
Specoli vaginali e rettali per piccoli animali
Rectal y vaginal espéculos para animales pequeños
Rectale et vaginale Spéculums pour petits animaux

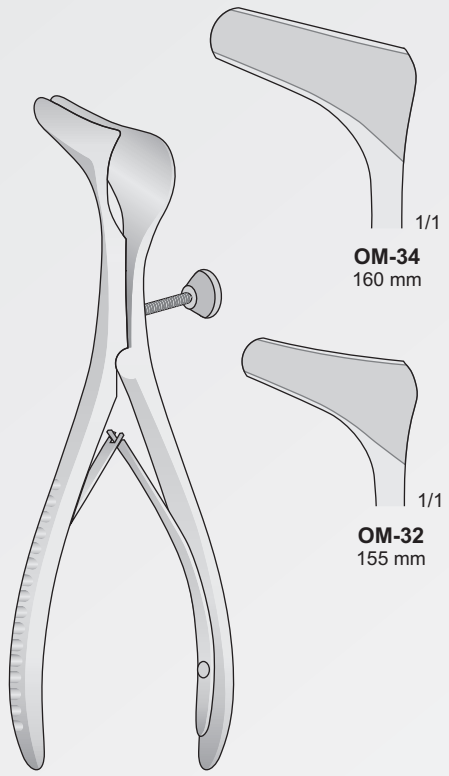

HARTMANN
OM-32/OM-34

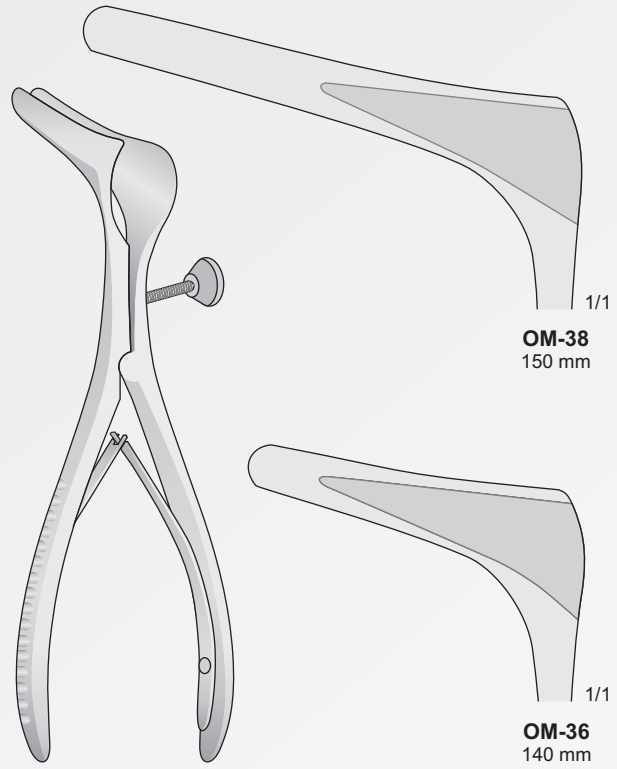

KILLIAN
OM-36/OM-38

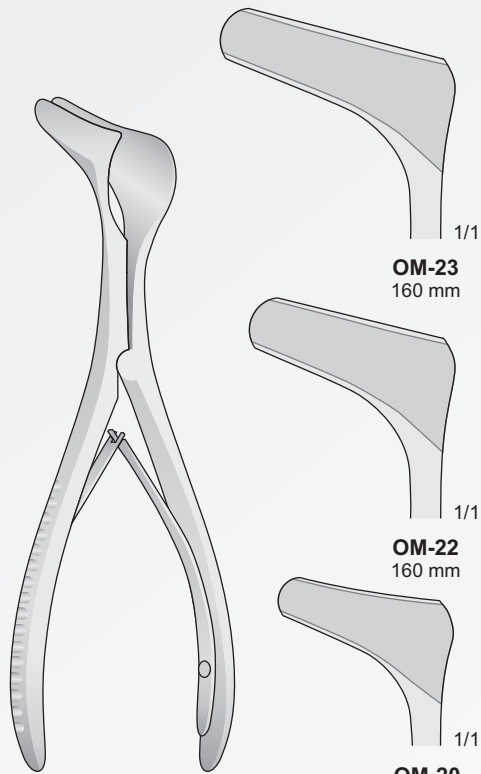

HARTMANN
OM-20/OM-23

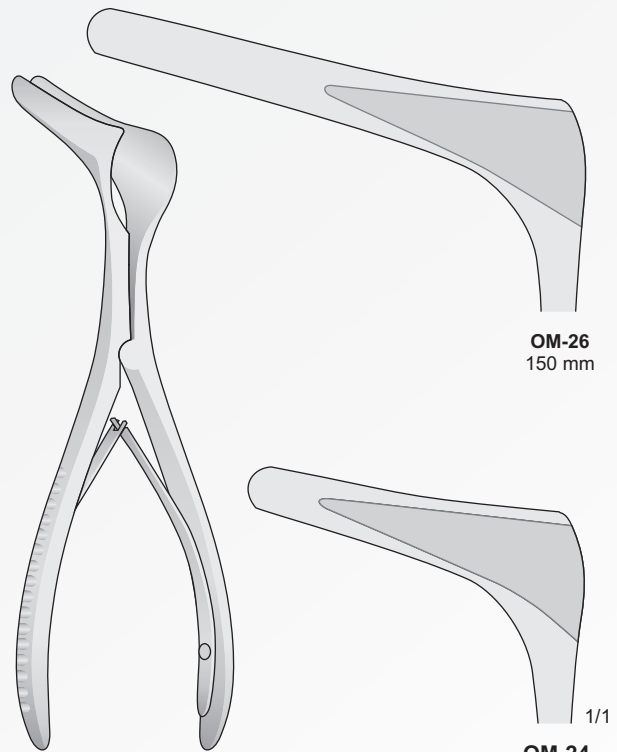

KILLIAN
OM-24/OM-26

Rektal und Vaginal-Spekula für Kleintiere
Specula for small animals for Vaginal and Rectal Examination
Specoli vaginali e rettali per piccoli animali
Rectal y vaginal espéculos para animales pequeños
Rectale et vaginale Spéculums pour petits animaux

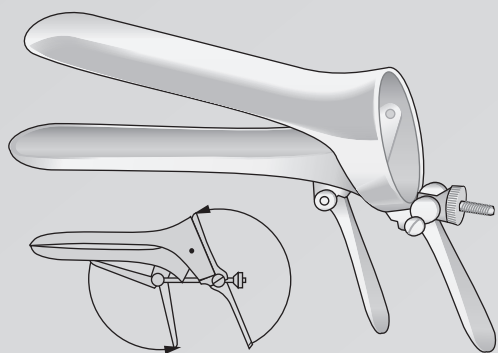

CUSCO
ER-49 Fig.0 77x17 mm

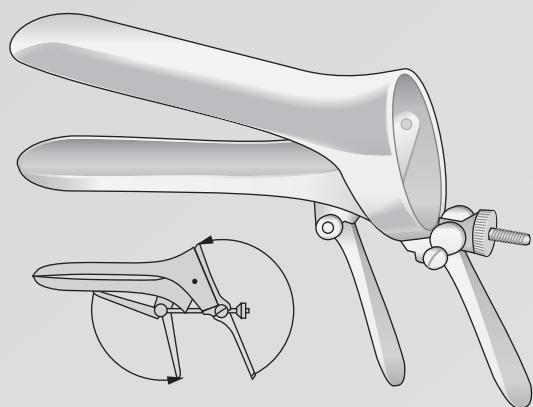

CUSCO
SCHWEIZER MODELL
ER-61 Fig.1 90x23 mm
ER-62 Fig.2 100x24 mm
ER-63 Fig.3 105x27 mm

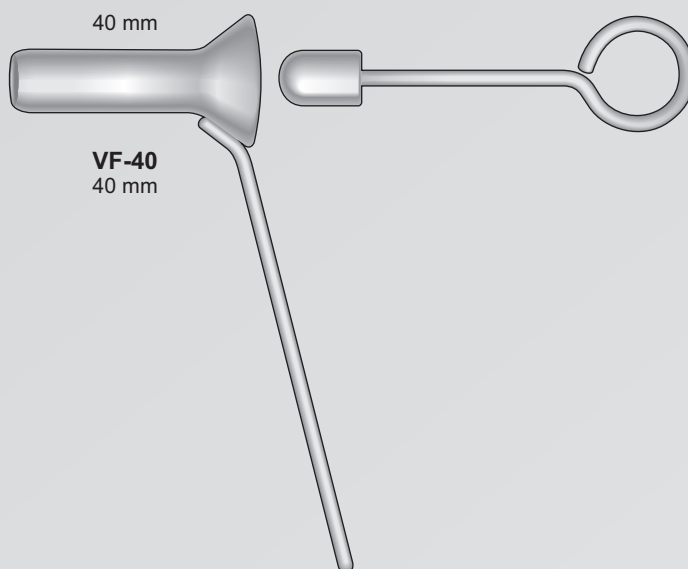

40 mm
VF-40
40 mm

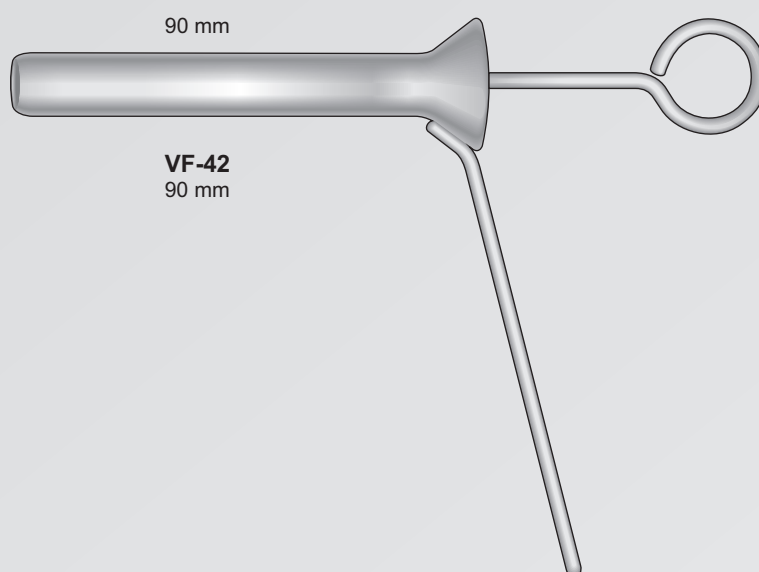

90 mm
VF-42
90 mm

Katheterspanner - Metallkatheter
Catheters metal
Cateteri - Sonde metalliche
Catéteres - Sondas metálicas
Sondes métalliques

| | Charr. |
|--------------|--------|
| EA-60 | 8 |
| EA-62 | 10 |
| EA-63 | 12 |
| EA-64 | 14 |
| EA-65 | 16 |
| EA-66 | 18 |
| EA-67 | 20 |



EA-60/EA-67
290 mm

| | Charr. |
|--------------|--------|
| EA-70 | 6 |
| EA-72 | 8 |
| EA-74 | 10 |
| EA-76 | 12 |
| EA-77 | 14 |
| EA-78 | 16 |
| EA-79 | 18 |



EA-70/EA-79
160 mm

Ø 2,0 mm
Ø 3,0 mm



MUNGILATTE
VF-132 Ø 2 mm
VF-133 Ø 3 mm
100 mm

Ø 2,0 mm
Ø 3,0 mm



FÜRSTENBERG
VF-117 Ø 2 mm
VF-123 Ø 3 mm
100 mm

Ø 4,0 mm



VF-112
440 mm

Ø 5,0 mm



VF-113
440 mm

Ø 5,0 mm



VF-114
420 mm

Ø 11,0 mm

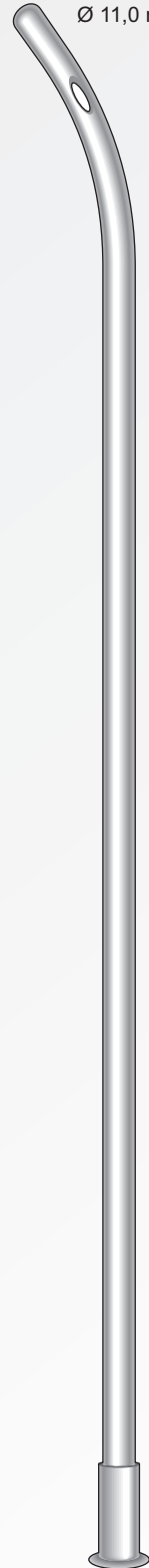

VF-110
550 mm

Zitzen Instrumente
Teat Instruments
Strumenti per nervi
Instrumentos para pezones
Instruments pour les nerfs

Strickanalschere
Teat Sitting Scissors
Forbice a doppio taglio
Tijera de doble filo
Ciseaux à double tranchant

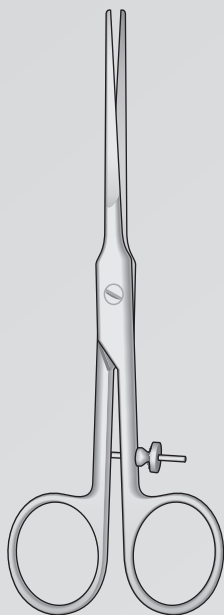

CHRESTENSEN
VH-10
155 mm

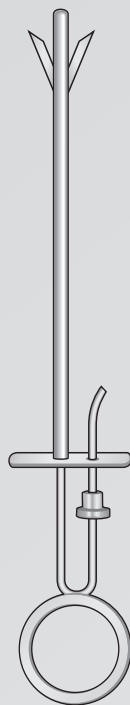

DÄNISCHES MOD.
VF-131
180 mm



HUG
VF-130
155 mm

Ø 3,0 mm



HUG
VF-116
150 mm

Ø 4,0 mm



HUG
VF-124
160 mm

Sterilisierhaken für Katzen
Spayhook for Cats
Uncini per sterilizzazione gatte
Ganchos esterilizantes para gatos
Crochets de stérilisation pour chats

Ø 4 mm

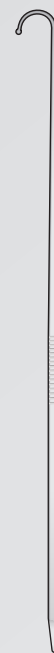

VF-102
170 mm

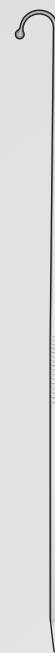

VF-102M
170 mm



BONTEMPI
CHIRURGISCHE INSTRUMENTE

Erhaltung für Instrumente, Steril-Container
Maintening of instruments, Sterilizing Containers
Mantenimento strumentario, Bacinelle e Box per Sterilizzazione
Mantenimiento del instrumental, Contenedores para esterilización
Nettoyage de l'instruments, Containers pour stérilizer

Kanülenreinigungs-bürsten
Cleaning brush for tubes
Scovolini per pulizia cannule
Cepillo para limpiar cánulas
Brosse de nettoyage pour canules

Special Gummi für Metal
Special Rubber for Metal
Gomme speciali per metalli

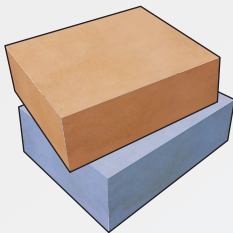

| | |
|---|---|
| DB-07 50 x 40 x 20 mm Fein - Fine Grana Fine Finas - Fin | DB-08 50 x 40 x 20 mm Größ - Large Grana grossa Grande - Large |
|---|---|

| | |
|--|---|
| Sterilisier bar Autoclavable Autoclavabile Esterilizabile Stérilisable | Handwaschbürste Nail brushes Spazzola per unghie Cepillos de uñas Brosse à ongles |
|--|---|

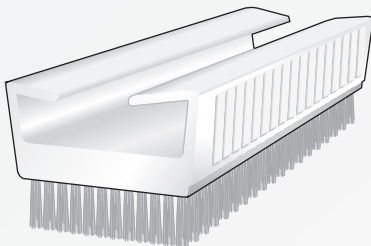

GF-200
4 x 11 cm



GF-40
235 mm



GF-188
220 mm

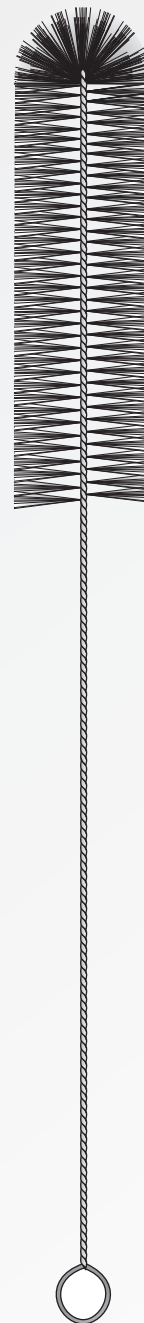

GF-187
300 mm

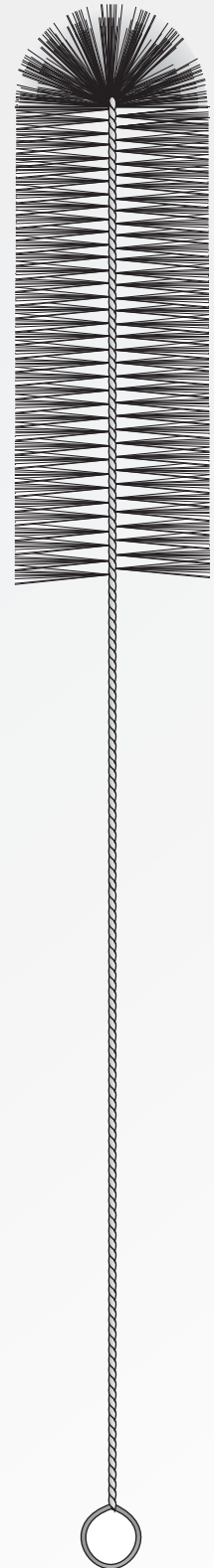

GF-189
360 mm

Erhaltung für instrumente
Maintaining of instruments
Mantenimento dello strumentario
Mantenimiento del instrumental
Nettoyage d'instruments

Wasserlösliche Schmiermittel
von chirurgische Instrumenten
Lubrificant Oil for surgical instruments
Olio lubrificante per strumenti chirurgici
Lubrificante para instrumentos
Entretien pour instruments

RODHOIL

Schmiermittel mit hoher Dichte. Es sichert den perfekten Gebrauch und die Leichtgängigkeit aller chirurgischen Instrumente. Man gibt es auf die Verbindungen und Gelenke und in alle beweglichen Teile, die Reibungen unterworfen sind.

RODHOIL

Lubrificant to high density. It assures the perfect utility and fluency of all the surgical instruments. For apply in to loosens, join and in all the parts in subject movement subject to attrition.

RODHOIL

Lubrificante ad alta densità. Assicura la perfetta funzionalità e scorrevolezza di tutti gli strumenti chirurgici. Da applicare negli snodi, giunture e in tutte le parti in movimento soggette ad attrito.



DB-OLR
50 cc

Das wasserlösliche Schmiermittel verlängert die Lebensdauer von chirurgische Instrumenten
Soluble lubricant extends useful life of surgical instruments
Lubrificante anticorrosivo e detergente per strumenti chirurgici
Lubrificante soluble en agua, so uso prolonga la duración de los instrumentos quirúrgicos
Lubrifiant soluble dans l'eau prolonge la vie des instruments chirurgicaux

CLEANLACT

Reinigungskonzentrat für chirurgische Instrumente. Es wirkt antibakteriell, nicht-ätzend und schmierig. Es garantiert die perfekte Erhaltung aller Instrumente aus Stahl, entfernt eventuelle Flecken, Ränder, und Bräunungen von Sterilisationen, Desinfektionen und Reinigungen mit hartem Wasser. Es sollte regelmäßig verwendet werden.

CLEANLACT

Product concentrated for surgical instruments. It explains an action anti-corrosive, antibacterium and lubricant. It guarantees the perfect maintenance of all the instruments in steel eliminating eventual stains and burnishes to sterilization, disinfection and to washings with hard waters. It used periodically.

CLEANLACT

Prodotto concentrato per strumenti chirurgici. Esplica un azione anticorrosiva batteriostatica e lubrificante. Garantisce il perfetto mantenimento di tutti gli strumenti in acciaio eliminando eventuali macchie, aloni e bruntiture dovute a sterilizzazioni, disinfezioni e a lavaggi con acque dure. Va usato periodicamente.



DB-50M
500 cc

DB-1L
1000 cc

Original Arkansas

Abziehsteine zum schärfen
Accessories for re-sharpening
Pietre ed accessori
Accessorios para el reafilado
Pierre et accessories

Arkansas Schleifsteine
Arkansas Sharpening Stone
Pietre di Arkansas per affilatura strumenti
Materiales de Arkansas para afilar
Pierres d'affutage de Arkansas

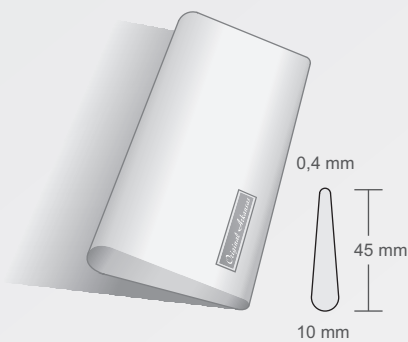

DB-6A
ARKANSAS n°6A
100 mm



DB-3
INDIA n°6
100 mm



DB-299
ARKANSAS
conica n° 299
90 mm



DB-4
ARKANSAS n°4
100 mm



DB-22A
ARKANSAS



DB-96
ARKANSAS n°8
100 x 50 x 13 mm



Schleifstein-Öl
Oil for grinding stones
Olio per affilatura strumenti
Huile d'affutage

DB-OL
30 cc

Sterilisierzangen zum Fassen und Halten Steriler Instrumente
Sterilizing forceps for picking up and holding of sterile instruments
Pinze per prelevare strumenti sterilizzati
Pinzas para esterilización
Pincas pour instruments stérilisés



GS-02
145 mm

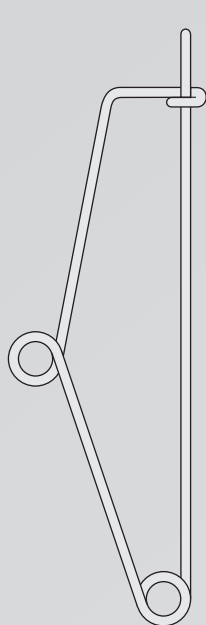

MAYO
GS-01
140 mm

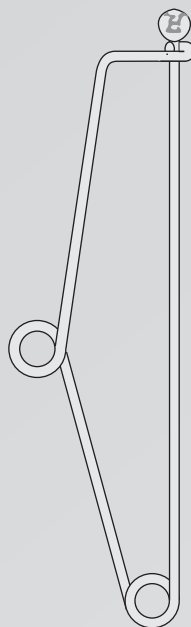

MAYO
GS-07
140 mm

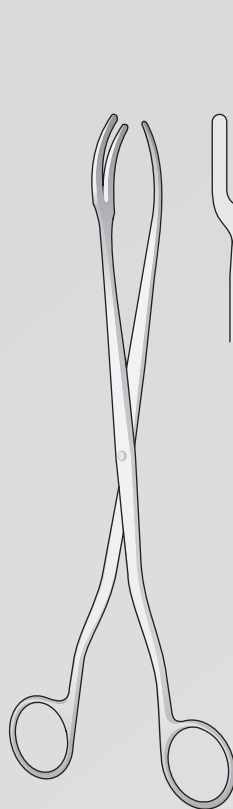

GS-10
200 mm

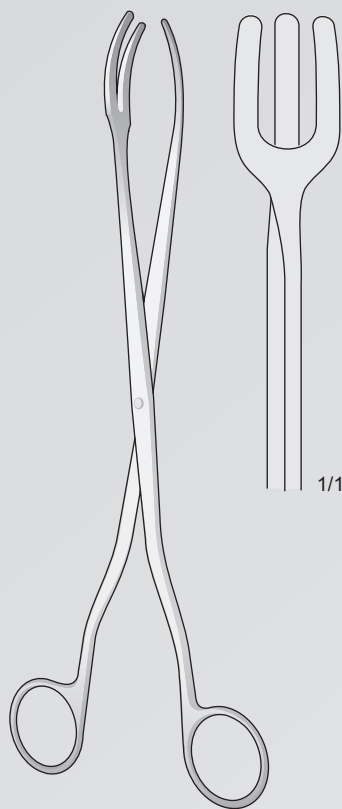

GS-11
300 mm

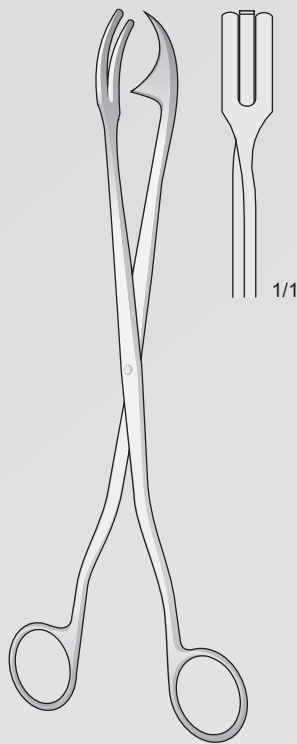

ROGGE
GS-06
230 mm

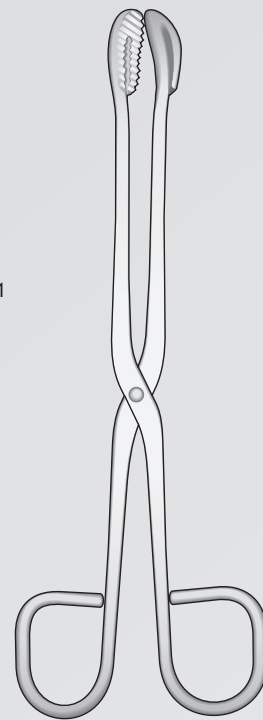

GS-13 200 mm
GS-14 300 mm

Matte en silicone
Silikon matte
Tappeti in aghi di silicone
Tapete en agujas de silicona
Tapis en Silicone

Sterilisierbar
Autoclavable
Autoclavabili

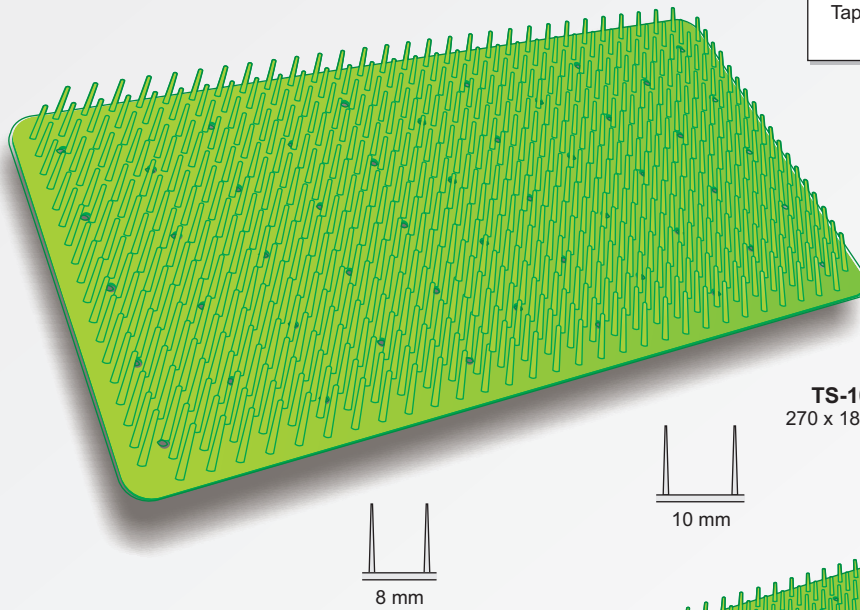
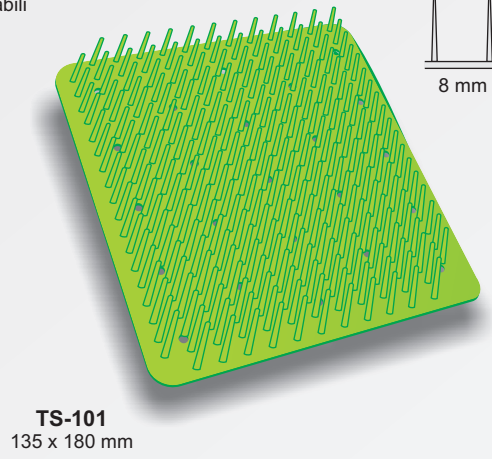
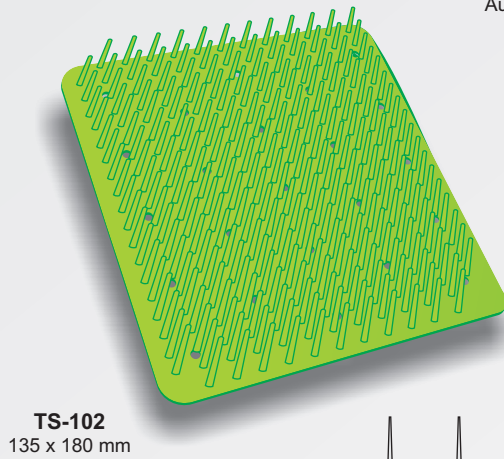

Silikon Matten
Matte en silicone
Tappeti in aghi di silicone
Tapete en agujas de silicona
Tapis en Silicone

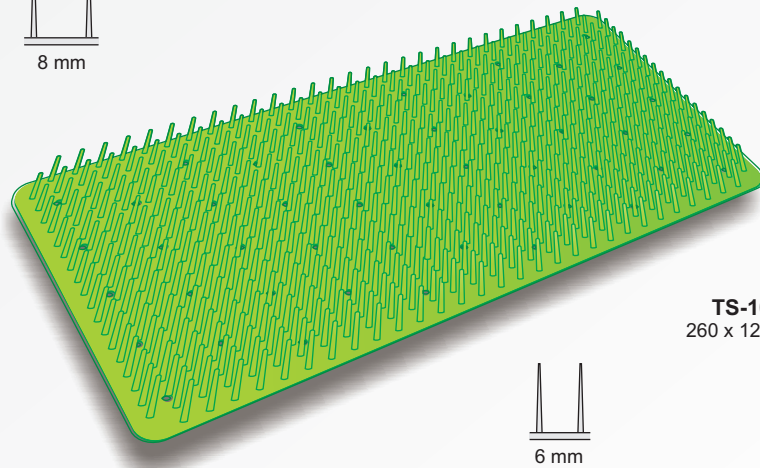

Steril Container
Sterilizing containers
Contenitori per sterilizzare
Contenedores para esterilización
Containers pour stérilizer

Rostfrei - Stainless steel - Acciaio Inossidabile
Acero inoxidable - Acier inoxydable

Bacinella a 7 scomparti

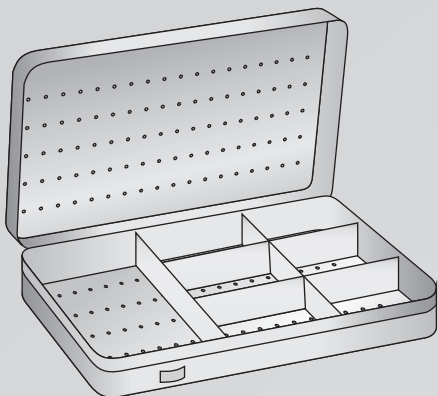

BS-27
150 x 90 x 20 mm

Bacinella a 3 scomparti

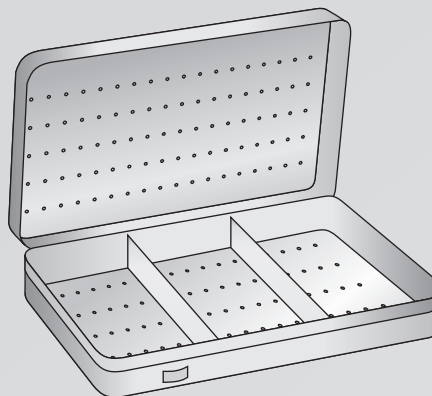

BS-23
150 x 90 x 20 mm

Instrumentenkästen
Instrument boxes
Scatole per sterilizzazione a secco
Cajas para instrumentos
Boites pour instruments

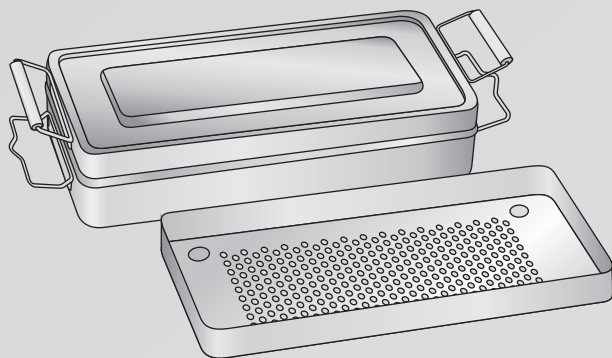

CS-61 150 x 90 x 40 mm
CS-67 320 x 150 x 60 mm

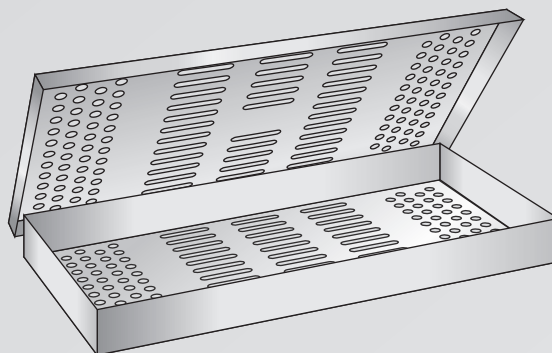

BS-41
275 x 130 x 25 mm

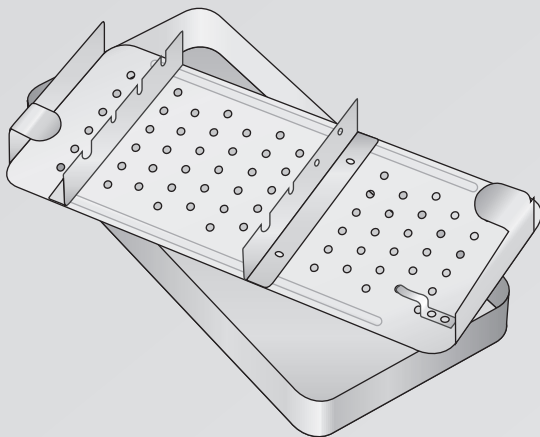

BS-30
180 x 90 x 35 mm 2 ripiani

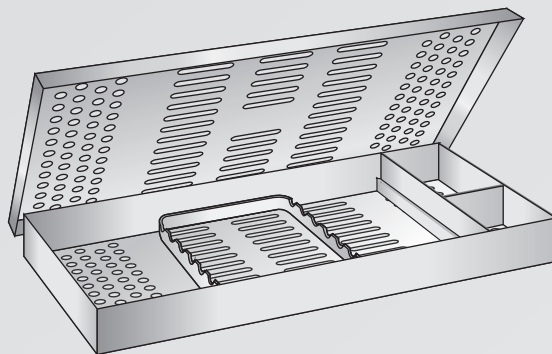

BS-40 275 x 130 x 25 mm Con griglia e scomparti
BS-42 285 x 190 x 25 mm Con griglia e scomparti

Schalen
Trays
Bacinelle
Bandejas
Bassins

Bacinelle reniformi
Kidney bowls
Nierenschalen
Bassins réniformes
Riñoneras



BR-20 200 mm
BR-25 250 mm
BR-28 280 mm

Vassoi porta-strumenti
Trays
Schalen
Bassins
Bandejas



VS-20 210 x 110 x 25 mm
VS-26 250 x 180 x 30 mm
VS-30 300 x 220 x 30 mm

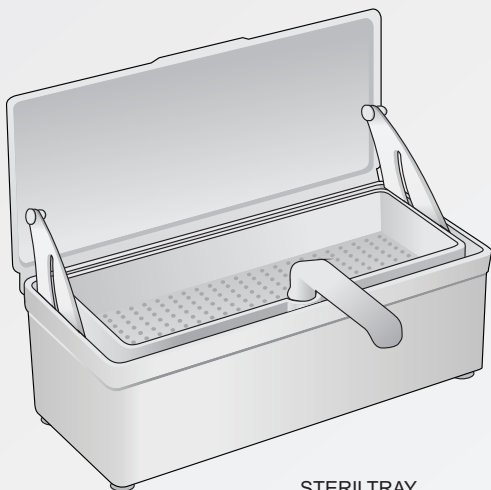

STERILTRAY
BS 100
25,5 X 10,5 X 8,5

Scatola per sterilizzazione aghi da sutura
Box for needles
Sterilbehälter für Nadeln
Boite pour aiguilles de suture
Estuche para agujas

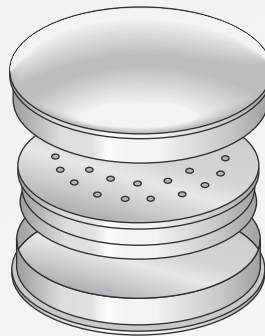

BS-1
Ø 78 mm h 15 mm

Capsule inox con fondo piano e becco
Lotion bowls capsules
Runder Sterilbehälter mit Ausguss
Capsule en acier inox

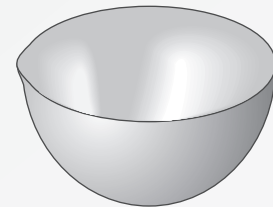

CS-01 Ø 40 mm 15 cc
CS-02 Ø 60 mm 75 cc
CS-03 Ø 80 mm 225 cc
CS-04 Ø 100 mm 325 cc
CS-05 Ø 120 mm 500 cc
CS-06 Ø 150 mm 600 cc

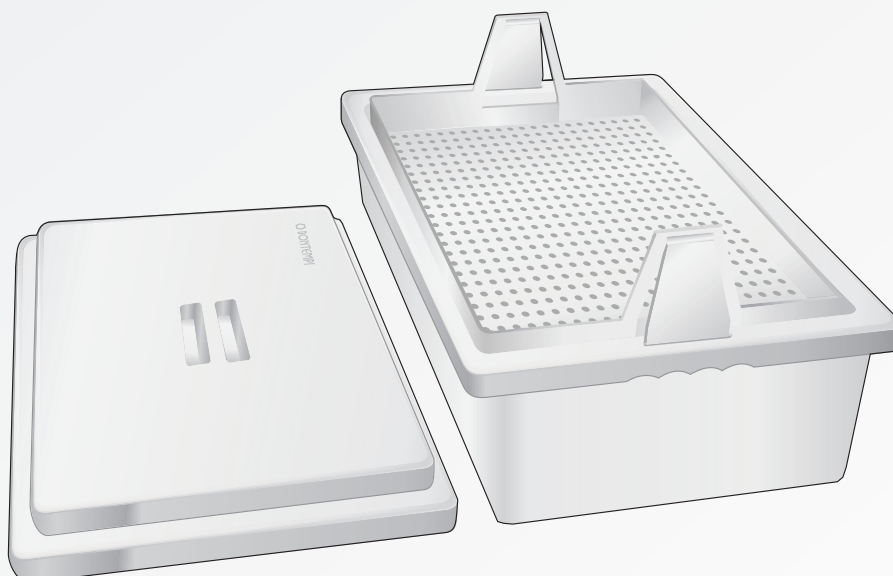

Plastica - Autoclavabile

BS-105
350 x 240 x 120 mm

Steril Container
Sterilizing containers
Contenitori per sterilizzare
Contenedores para esterilización
Containers pour stérilizer



Kleinsetcontainer / Mini Container

Außen / outside / esterno
exterior / extérieur
300 x 140 x 40 mm

- CT-555
- CT-556
- CT-557
- CT-558
- CT-559

Innen / inside / interno
interior / intérieur
280 x 130 x 27 mm

Kleinsetcontainer / Mini Container

Außen / outside / esterno
exterior / extérieur
300 x 140 x 70 mm

- CT-560
- CT-561
- CT-562
- CT-563
- CT-564

Innen / inside / interno
interior / intérieur
280 x 130 x 55 mm

Kleinsetcontainer / Mini Container

Außen / outside / esterno
exterior / extérieur
300 x 140 x 100 mm

- CT-565
- CT-566
- CT-567
- CT-568
- CT-569

Innen / inside / interno
interior / intérieur
280 x 130 x 84 mm

TS-103

260 x 120 mm - 6 mm

Silikon Noppenmatten
Silicon Mats
Tappeti in aghi di silicone
Tapete en agujas de silicona
Tapis de silicone

Sterilisierbar
Autoclavable
Autoclavabili
Esterilizable
Stérilisable

CT-660

94 x 215 mm - Box 1 pc.

Teflon Filter für 1200 Zyklen
Teflon Filter for 1200 cycles
Filtro in teflon per 1200 cicli
Filtro de teflón para 1200 ciclos
Filtre de téflon pour 1200 cycles

CT-670

Box 100 pc.

Kunststoff-Dichtungen
Plastic seals
Sigilli di plastica
Sellos de plástico
Scellés en plastique

CT-672

Box 100 pc.

Label Einweg
Disposable-Label
Etichetta monouso
Etiqueta desechables
Étiquettes jetables

CT-702

65 x 65 mm

Baumwolle Handtuch Verpackung
Cotton Towel Packaging
Telo in cotone per confezionamento
Embalaje de toallas de algodón
Emballage de serviettes de coton

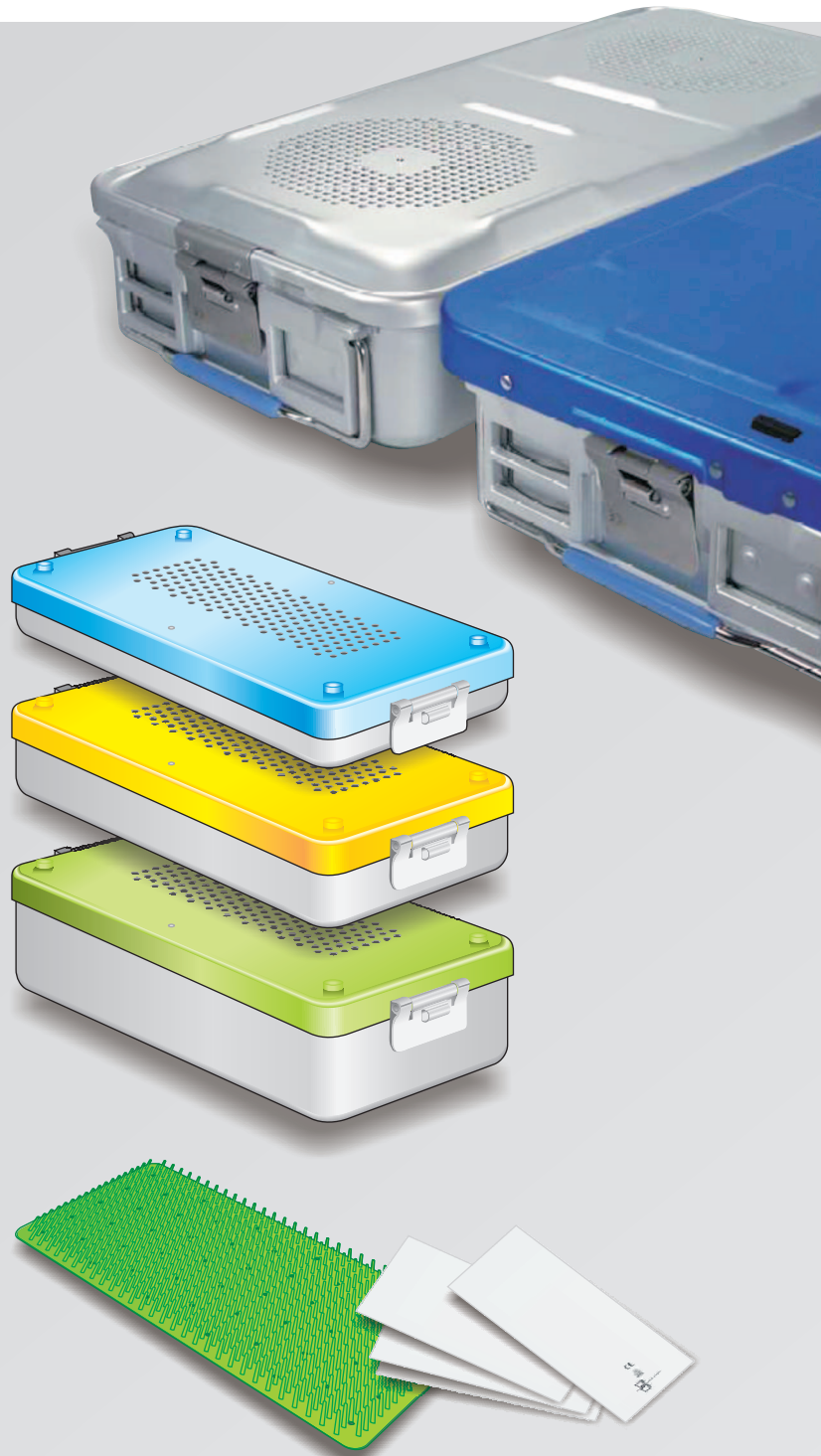



BONTEMPI
CHIRURGISCHE INSTRUMENTE

Tier Zahnmedizin
Animal Dentistry
Odontoiatria animale
Odontologia animal
Animaux dentisterie

Zahnzangen Englische Form
Extracting Forceps English Pattern
Pinze per estrazione Forma Inglese
Pinzas da extracciòn Forma Inglesa
Daviers Forme Anglaise

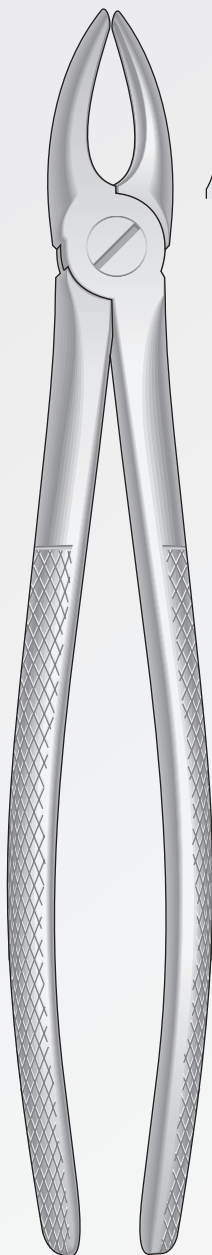

1
Fig. 1

Obere Schneide- und Eckzähne
Upper Incisors and cuspids
Incisivi e canini superiori
Incisivos y caninos superiores
Incisives et canines supérieures

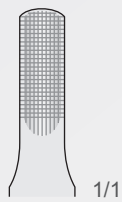

1/1

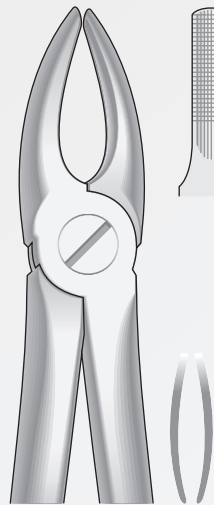

2
Fig. 2

Obere Schneide- und Eckzähne
Upper Incisors and cuspids
Incisivi e canini superiori
Incisivos y caninos superiores
Incisives et canines supérieures

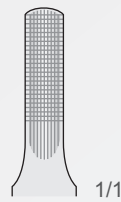

1/1

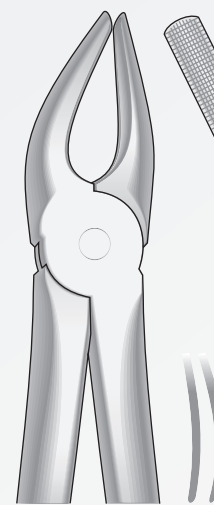

7
Fig. 7

Obere Prämolaren
Upper premolars
Premolari superiori
Premolares superiores
Prémolaires supérieures

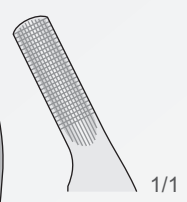

1/1

Zahnzangen Englische Form
Extracting Forceps English Pattern
Pinze per estrazione Forma Inglese
Pinzas da extracciòn Forma Inglesa
Daviers Forme Anglaise

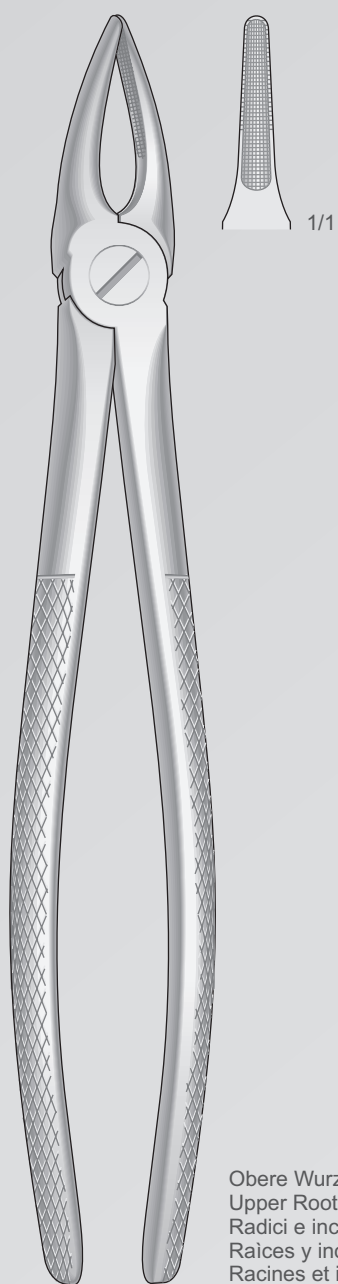

Obere Wurzeln und Schneidezähne
Upper Roots and incisors
Radici e incisivi superiori
Raíces y incisivos superiores
Racines et incisives supérieures

29
Fig. 29

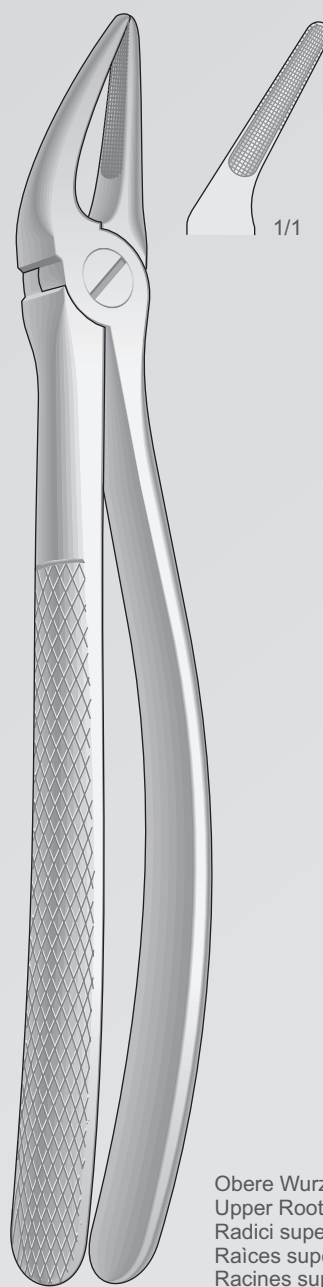

Obere Wurzeln
Upper Roots
Radici superiori
Raíces superiores
Racines supérieures

30
Fig. 30

Zahnzangen Englische Form
Extracting Forceps English Pattern
Pinze per estrazione Forma Inglese
Pinzas da extracciòn Forma Inglesa
Daviers Forme Anglaise

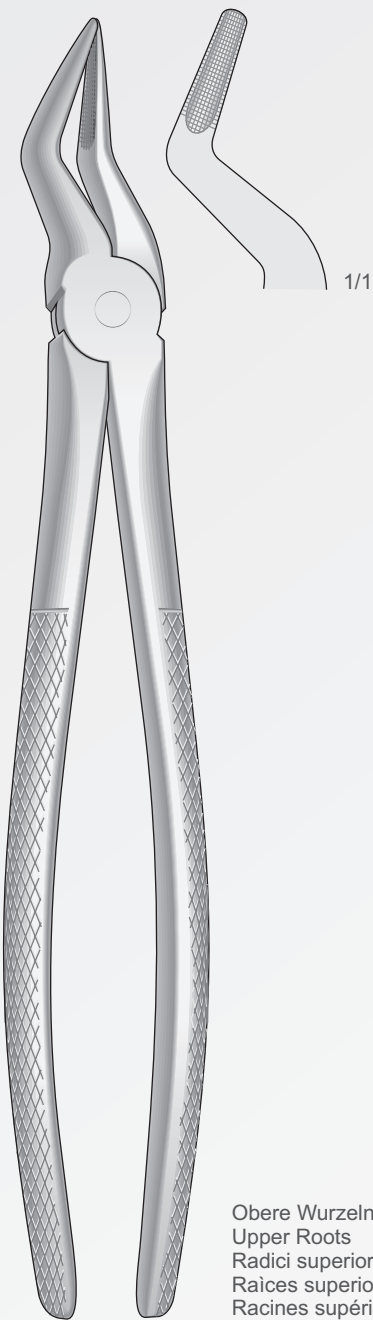

51
Fig. 51

Obere Wurzeln
Upper Roots
Radici superiori
Raíces superiores
Racines supérieures

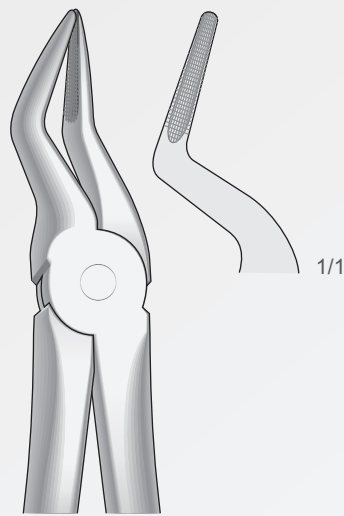

51A
Fig. 51A

Obere Wurzeln
Upper Roots
Radici superiori
Raíces superiores
Racines supérieures

Molaren
Pedo Lower Molars
Molari
Molares
Molaires

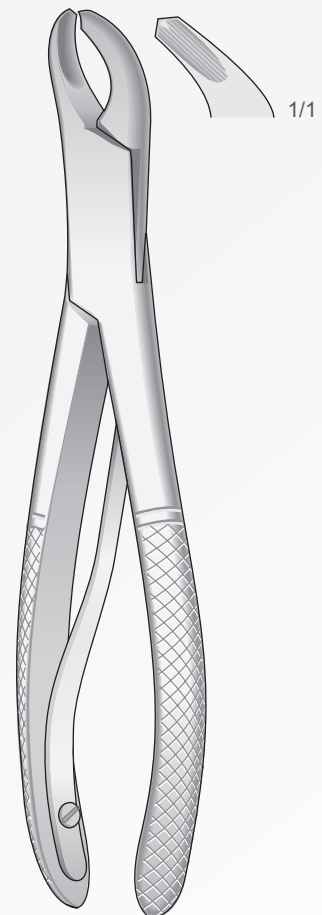

PEB-17S
Fig. 17SK

Zahnzangen Englische Form
Extracting Forceps English Pattern
Pinze per estrazione Forma Inglese
Pinzas da extracciòn Forma Inglesa
Daviers Forme Anglaise

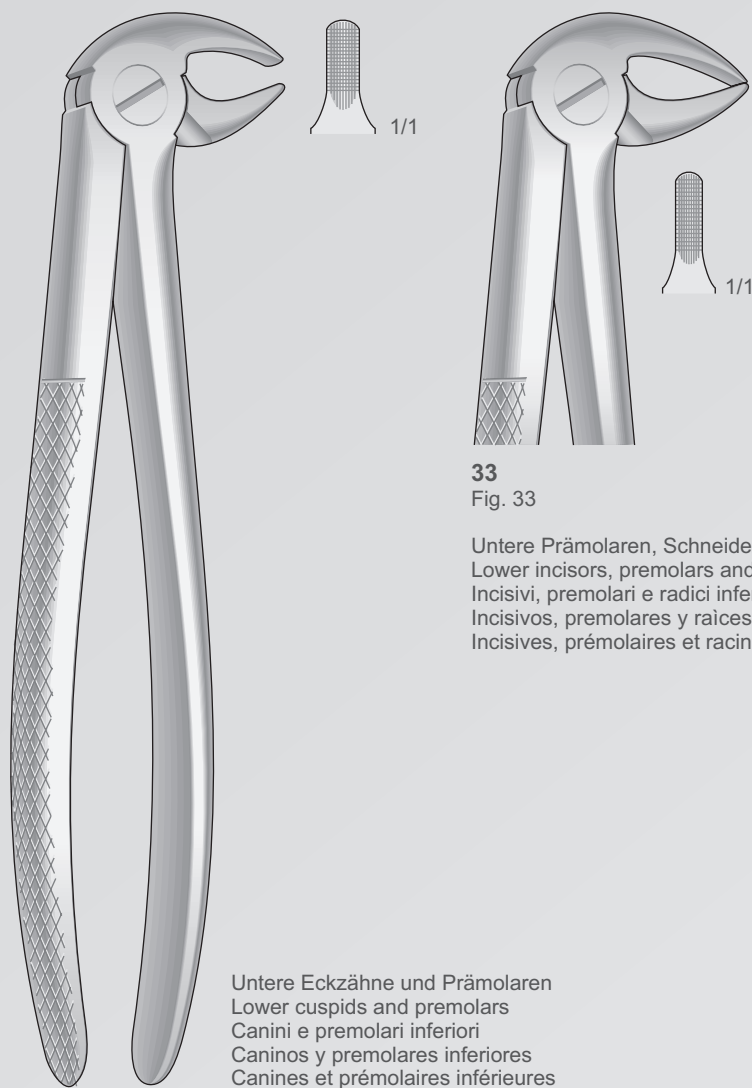

Zahnzangen Englische Form
Extracting Forceps English Pattern
Pinze per estrazione Forma Inglese
Pinzas da extracciòn Forma Inglesa
Daviers Forme Anglaise

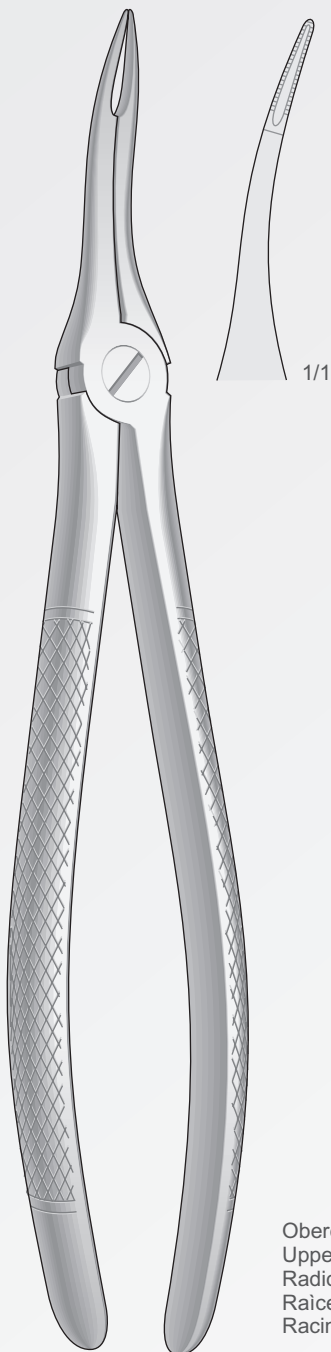

49
Fig. 49

Obere Wurzeln sehr feine
Upper very fine roots
Radici superiori molto sottili
Raíces superiores muy finas
Racines supérieures très fines

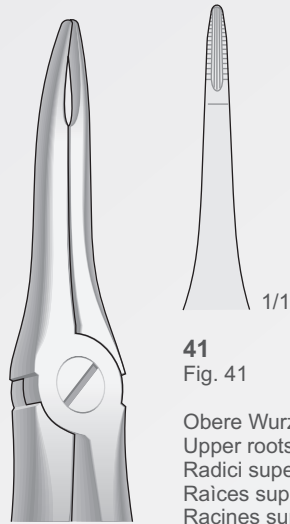

41
Fig. 41

Obere Wurzeln
Upper roots
Radici superiori
Raíces superiores
Racines supérieures

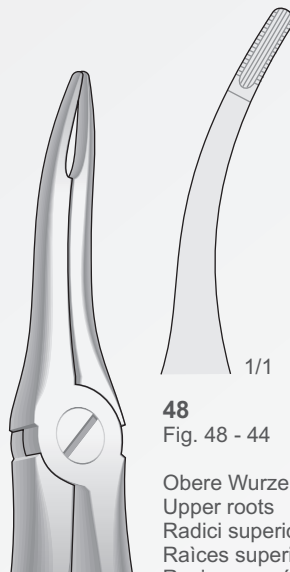

48
Fig. 48 - 44

Obere Wurzeln
Upper roots
Radici superiori
Raíces superiores
Racines supérieures

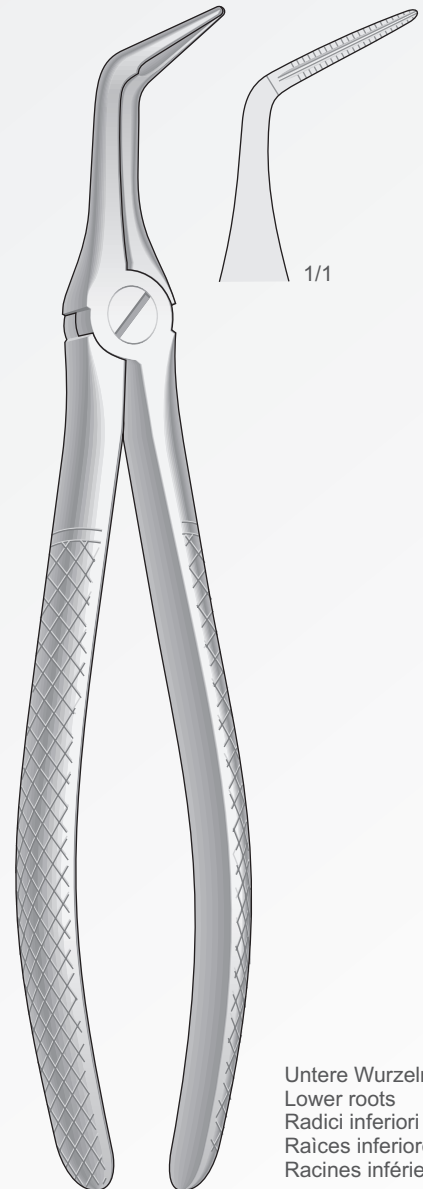

46L
Fig. 46L

Untere Wurzeln
Lower roots
Radici inferiori
Raíces inferiores
Racines inférieures

Zahnzangen Englische Form
Extracting Forceps English Pattern
Pinze per estrazione Forma Inglese
Pinzas da extracciòn Forma Inglesa
Daviers Forme Anglaise

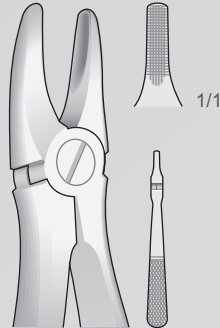

PEB-1
Fig. 137

Obere Schneidezähne
Upper Incisors
Incisivi superiori
Incisivos superiores
Incisives supérieures

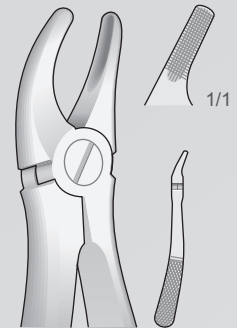

PEB-2
Fig. 139

Obere Prämolaren
Upper Premolars
Premolari superiori
Premolares superiores
Prémolaires supérieures

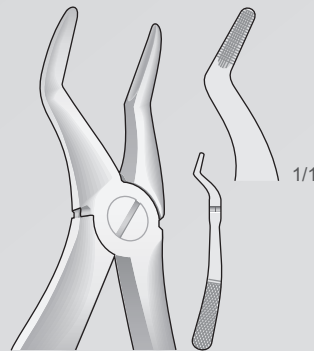

PEB-4
Fig. 51S

Obere Wurzeln
Upper roots
Radici superiori
Raíces superiores
Racines supérieures

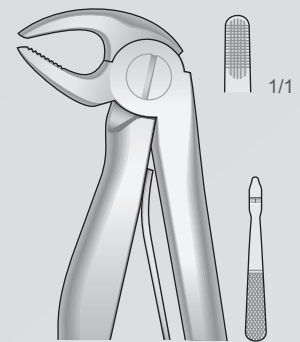

PEB-5
Fig. 5

Untere Schneidezähne
Lower incisors
Incisivi inferiori
Incisivos inferiores
Incisives inférieures

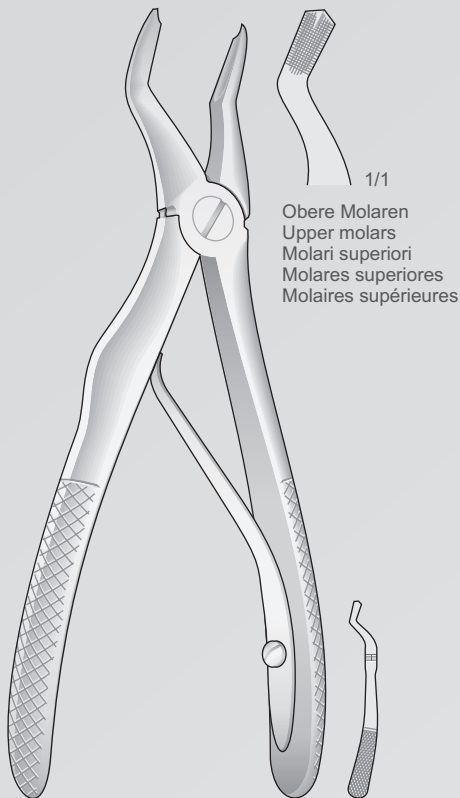

PEB-3

Obere Molaren
Upper molars
Molari superiori
Molares superiores
Molaires supérieures

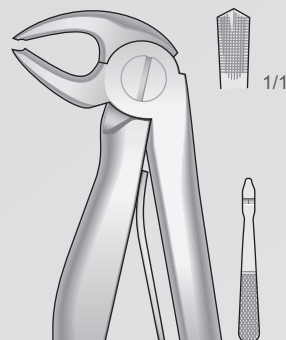

PEB-6
Fig. 6

Untere Molaren
Lower Molars
Molari inferiori
Molares inferiores
Molaires inférieures

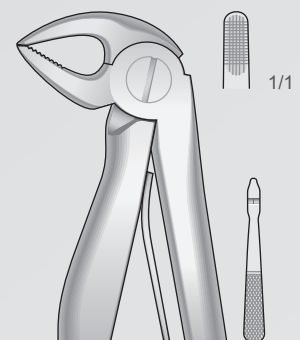

PEB-7
Fig. 7

Untere Wurzeln
Lower roots
Radici inferiori
Raíces inferiores
Racines inférieures

Fragmente- und Wurzelstiftezaugen
Pliers fragments and root canal pins
Pinze per frammenti e perni canalari
Alicates para fragmentos y los pins del conducto radicular
Pincas pour Fragments et épingles de canal

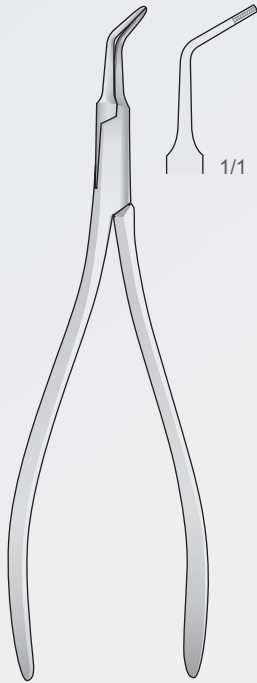

DA-01
130 mm

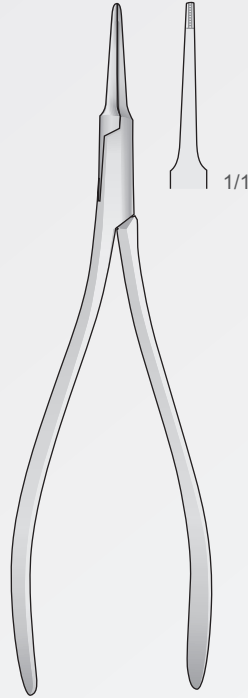

DA-02
130 mm

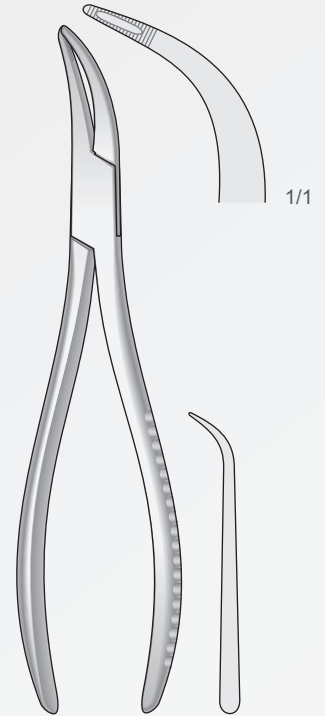

**WITZEL
DK-28**
165 mm

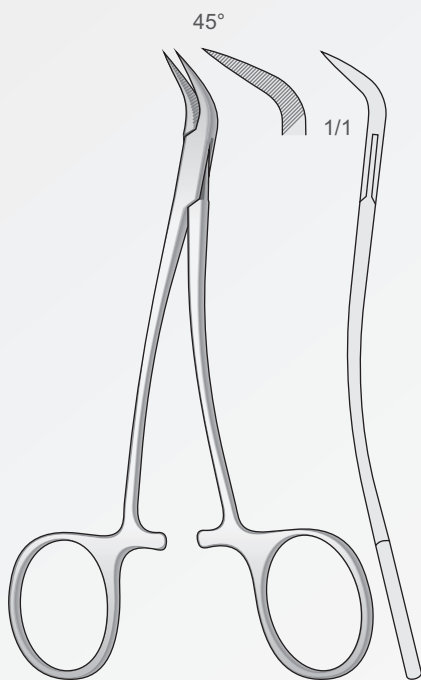

**PEET
DR-40**
120 mm

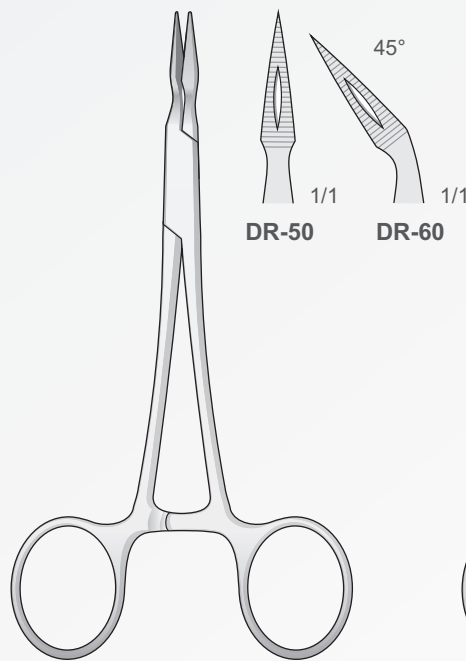

**STIEGLITZ
DR-50/DR-60**
140 mm

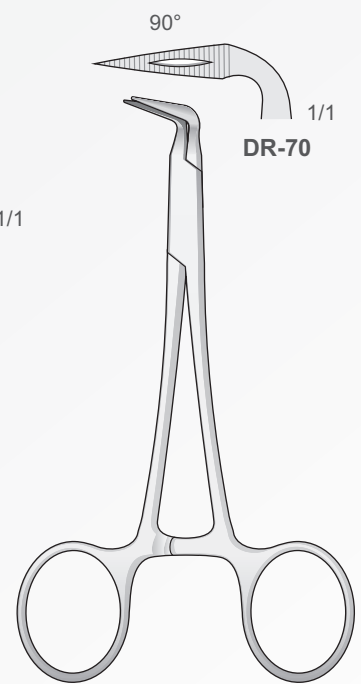

**STIEGLITZ
DR-70**
120 mm

Wurzelheber
Root Elevators
Leve per radici
Elevadores para raices
Elevateurs à racines

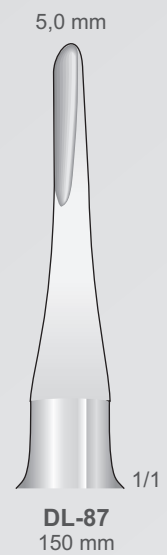
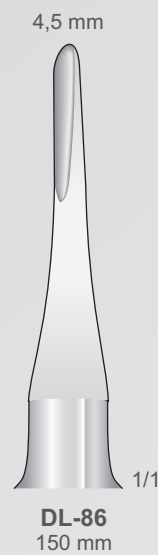
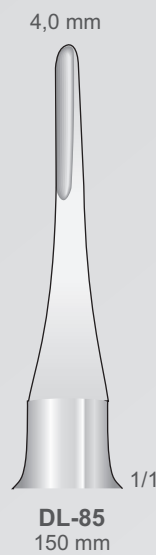
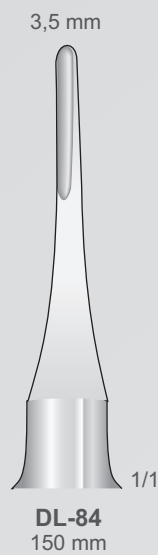
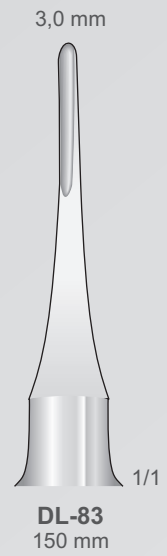
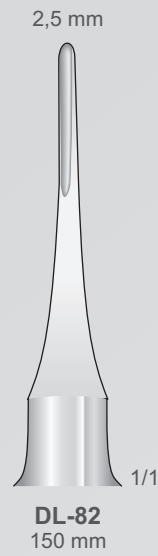
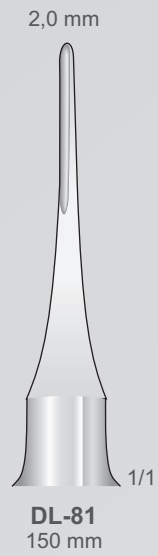

DL-81/DL-87
150 mm

Wurzelheber
Root Elevators
Leve per radici
Elevadores para raices
Elevateurs à racines

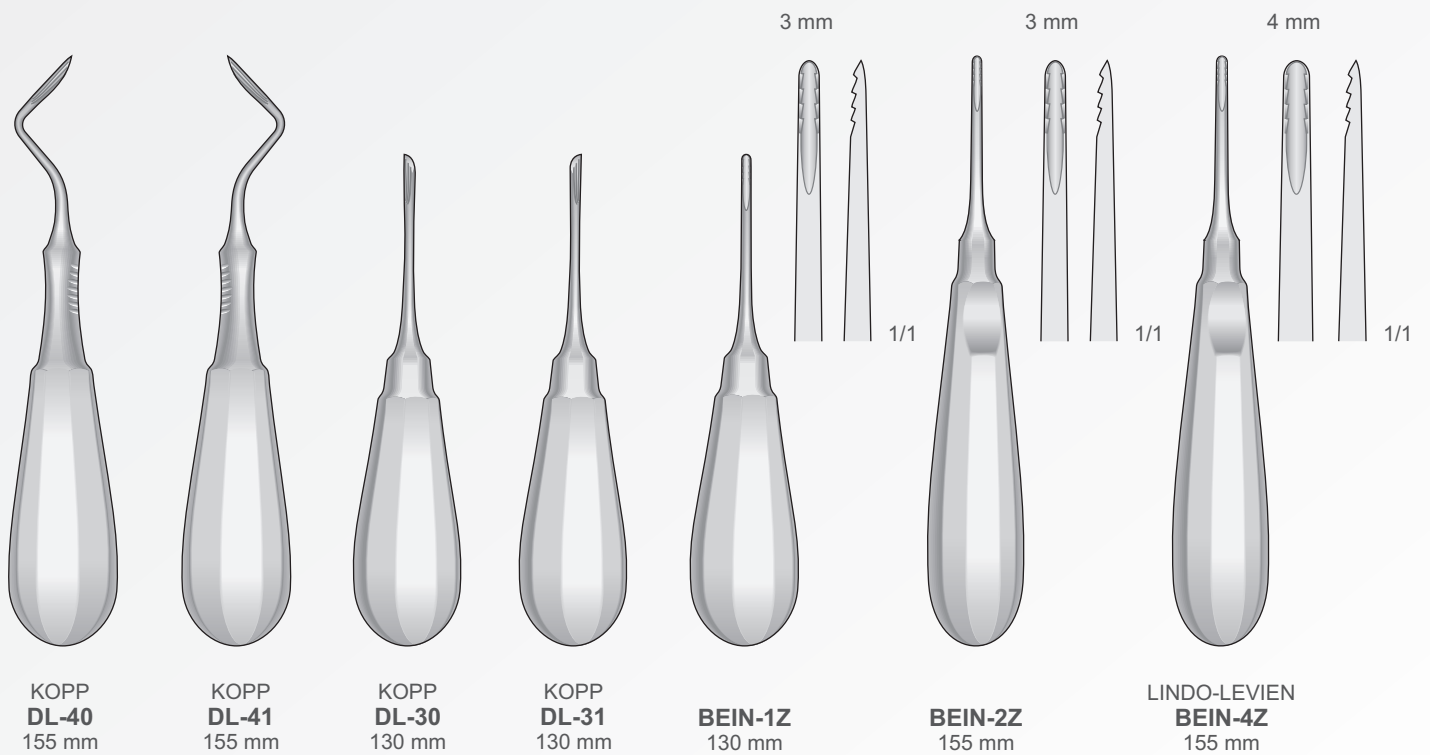

Wurzelheber
Root Elevators
Leve per radici
Elevadores para raices
Elevateurs à racines

Wurzelheber
Root Elevators
Leve per radici
Elevadores para raices
Elevateurs de racines

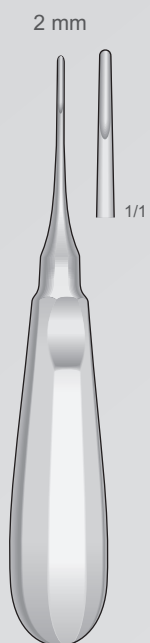

BEIN-2
155 mm

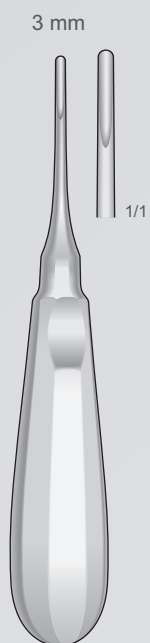

BEIN-3
155 mm

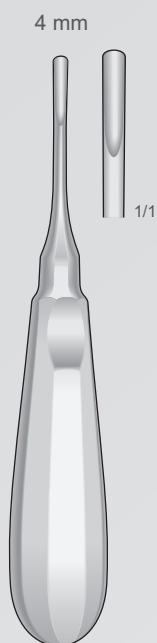

BEIN-4
155 mm



Obere
Upper
Superiori
Superiores
Supérieures

WARWICK-JAMES
DL-20
160 mm



Untere
Lower
Inferiori
Inferiores
Inférieures

WARWICK-JAMES
DL-21
155 mm



Untere
Lower
Inferiori
Inferiores
Inférieures

WARWICK-JAMES
DL-22
155 mm

Wurzelheber
Root Elevators
Leve per radici
Elevadores para raices
Elevateurs à racines



FLOHR-1
140 mm

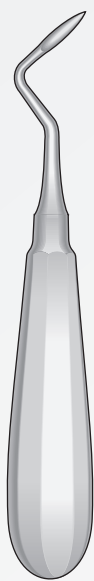

FLOHR-2
150 mm

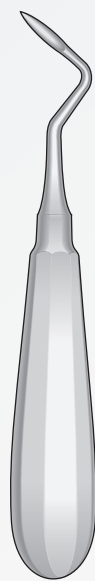

FLOHR-3
150 mm

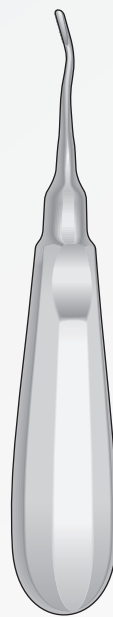

APEXO
DL-37/DL-38
160 mm

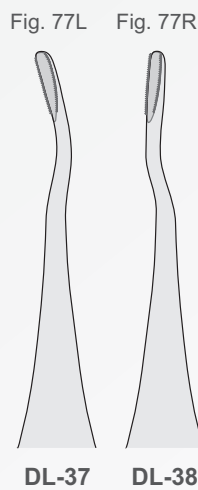

DL-37 **DL-38**



Gezahnt
Serrated
Dentellate
Dentadas
Dentelé



Eine seite gezahnt
One side serrated
Un lato dentellato
Dentadura más lado
Dentelure sur un côté



DL-78
155 mm



DL-79
155 mm

Wurzelheber
Root Elevators
Leve per radici
Elevadores para raices
Elevateurs à racines

Luxatoren
Luxators
Lussatori
Luxadores
Luxateurs

Wurzelspitzenheber
Root fragment Elevators
Leve per frammenti di radice
Elevadores para fragmentos de raices
Elévateurs de fragments de racines

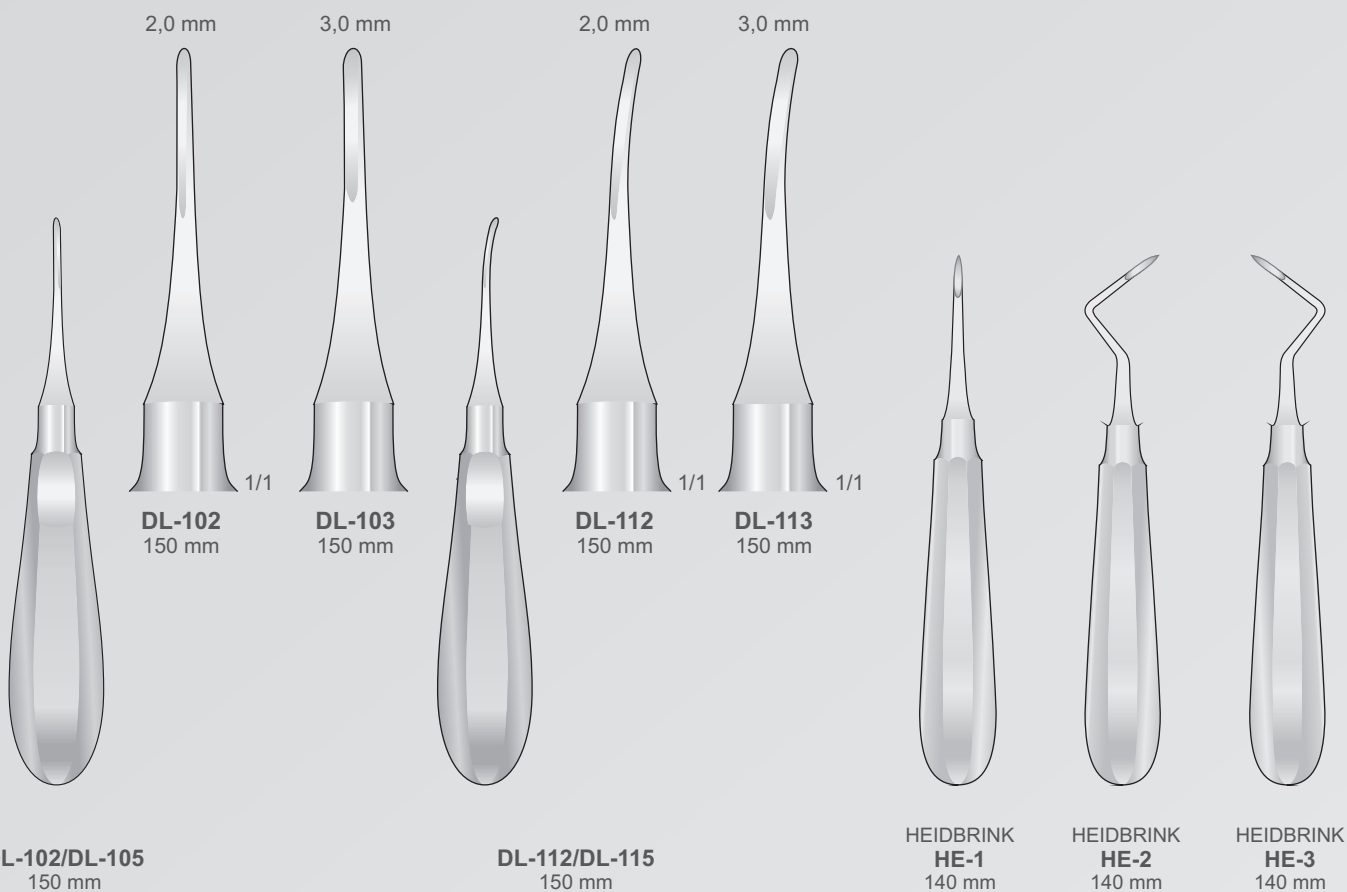

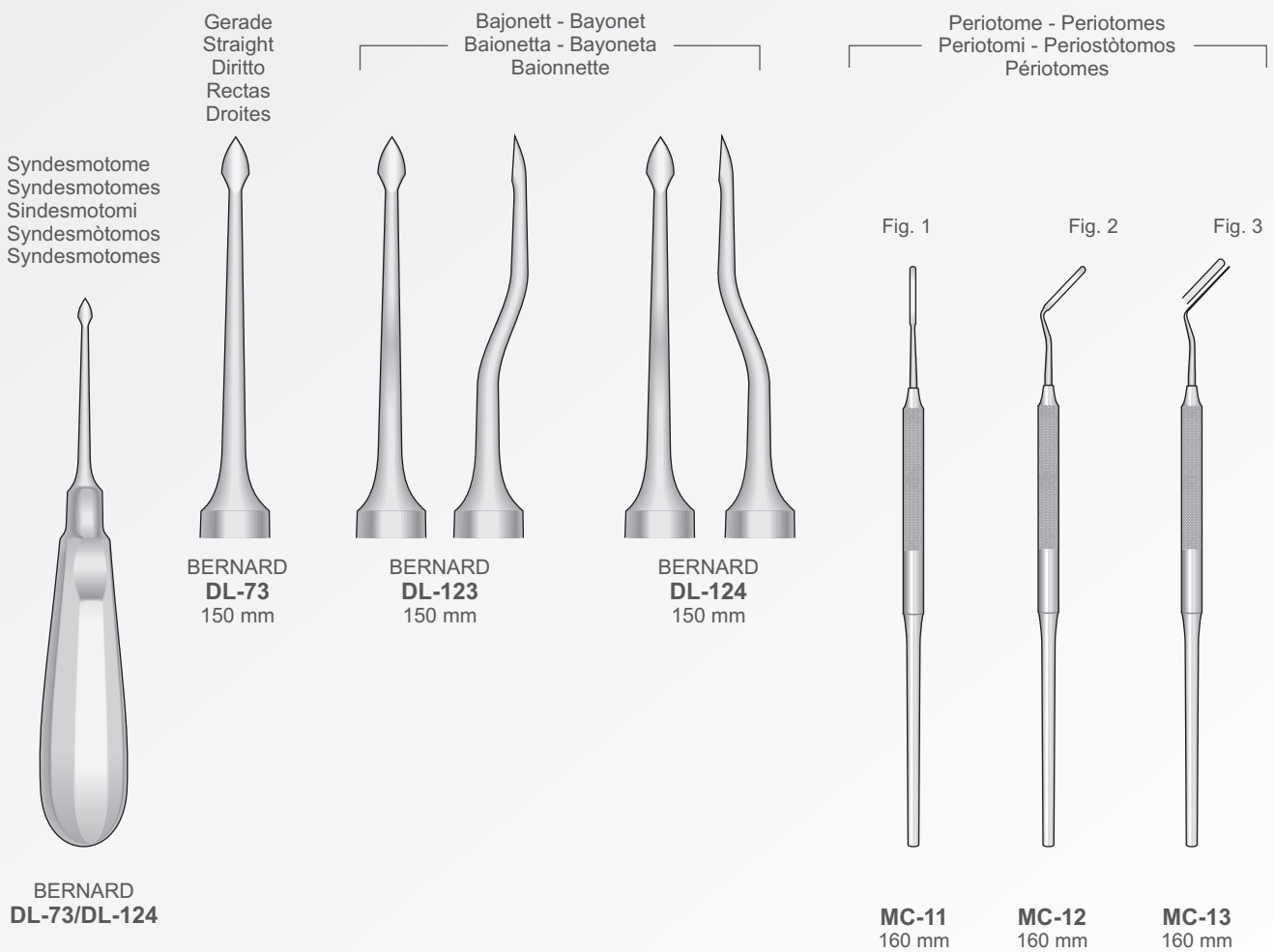

Mundsperrer
Mouth Gags
Apri bocca
Abre bocas
écarteur buccal

Erweitert Wange
Widens Cheek
Allargaguancia
Amplía la mejilla
Élargit la joue



VF-121M
40 mm

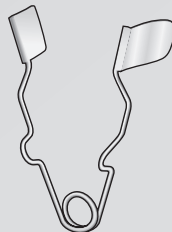

VF-121
60 mm

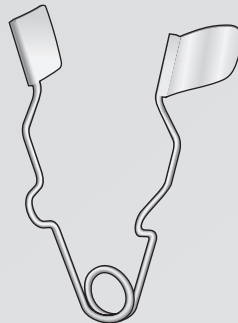

VF-122
85 mm

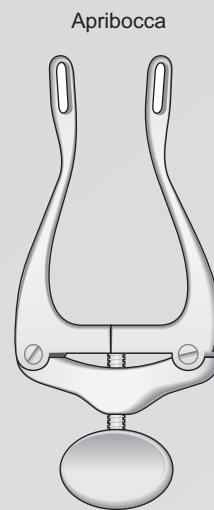

SCHMIDTKE
VF-120
120 mm

Katzen - Cats
Gatti - Gatos
Chats

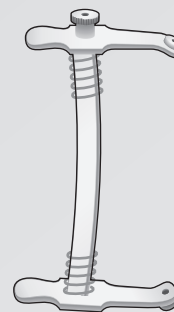

VH-48 60 mm
VH-49 80 mm

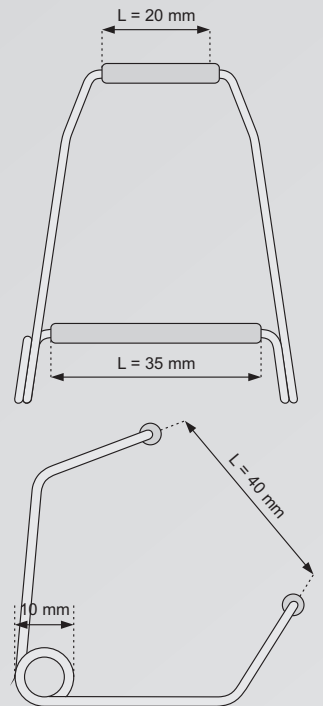

VH-46 40 mm
VH-52 60 mm
VH-53 105 mm
VH-54 150 mm
VH-55 175 mm

Hunde - Dogs
Canis - Perros
Chiens

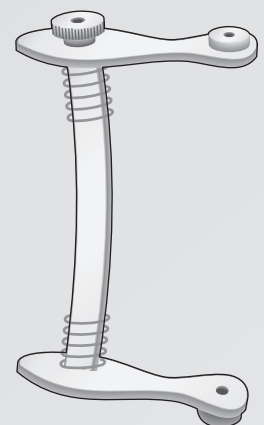

VH-50 110 mm
VH-51 160 mm



VH-16
175 mm

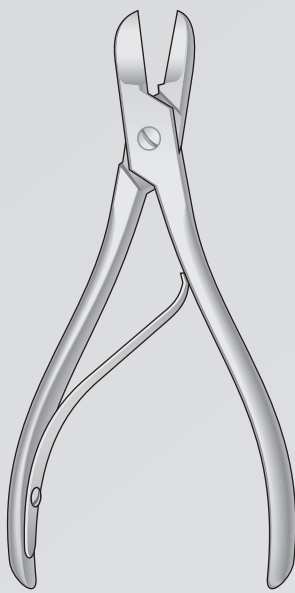

LX-70
155 mm

Wurzelheber
Root elevators
Leve per radici
Elevadores para raíces
Elevateurs à racines

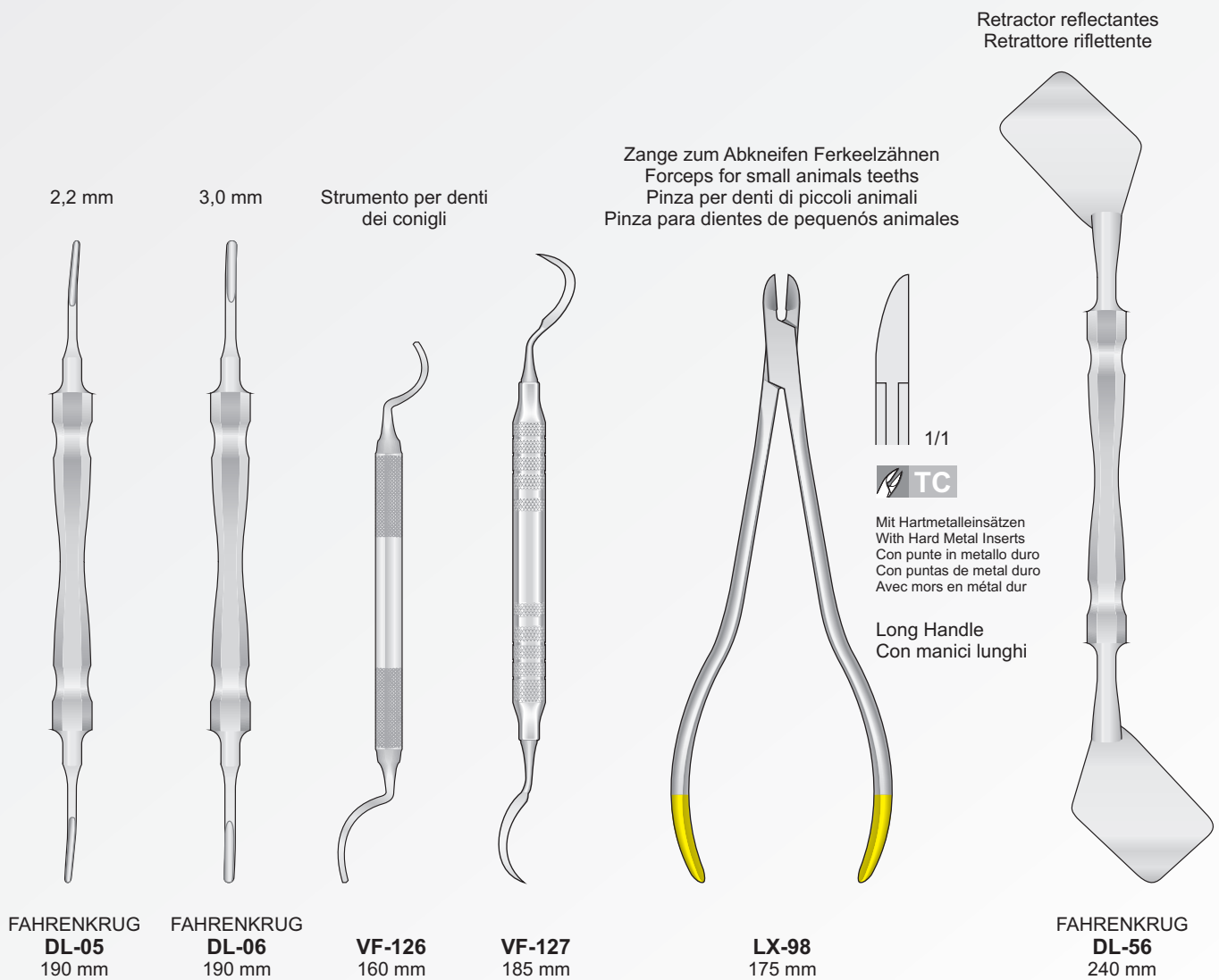

Syndesmotome und Küretten
Syndesmotome and Currettes
Sindesmotomo e Curette
Syndesmotomo y Curetas
Syndesmotome et Curetts

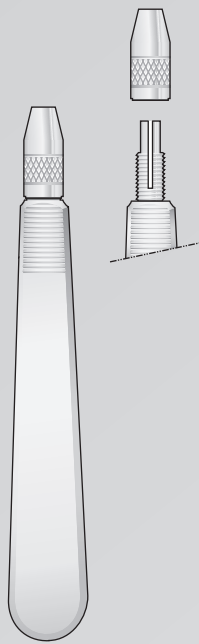

SD-M

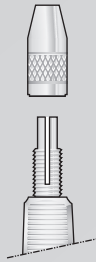

Cervical Blades
Lame cervicali
Hojas cervical
Lames pour
syndesmotome

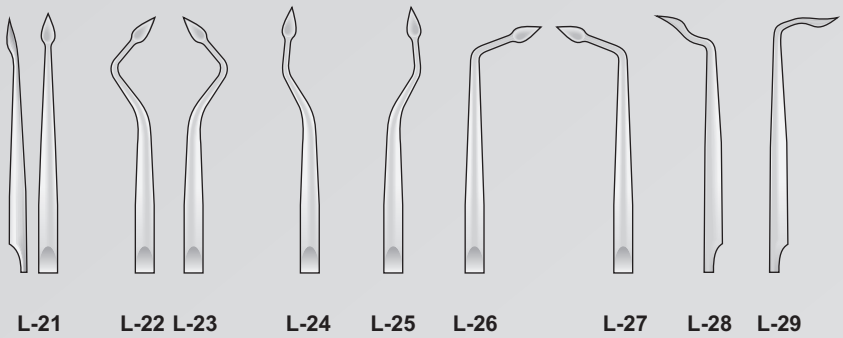
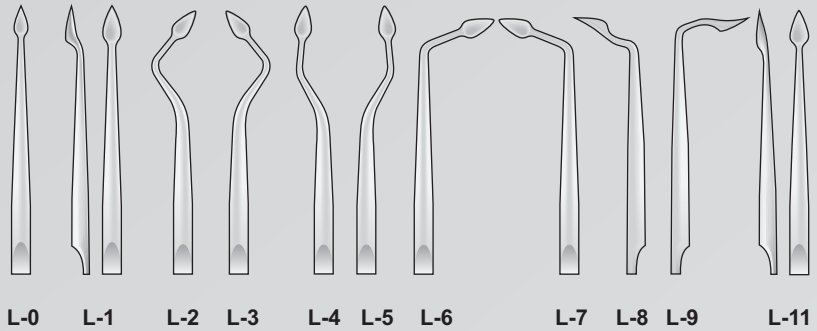

Apical Blades
Lame apicali
Hojas apical

L-21 L-22 L-23 L-24 L-25 L-26 L-27 L-28 L-29

Scalers

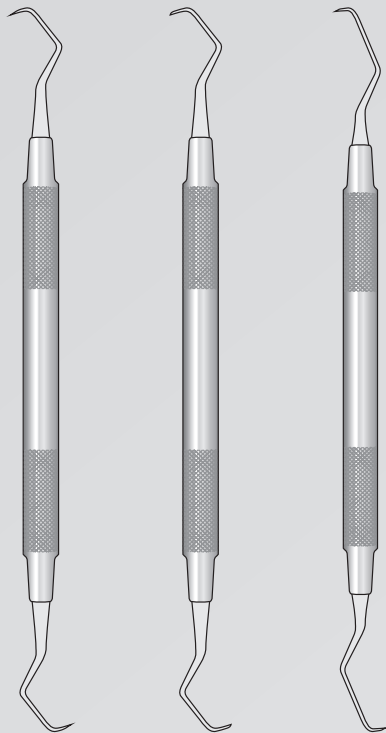

718-M23
165 mm

718-M23A
165 mm

718-M23B
170 mm

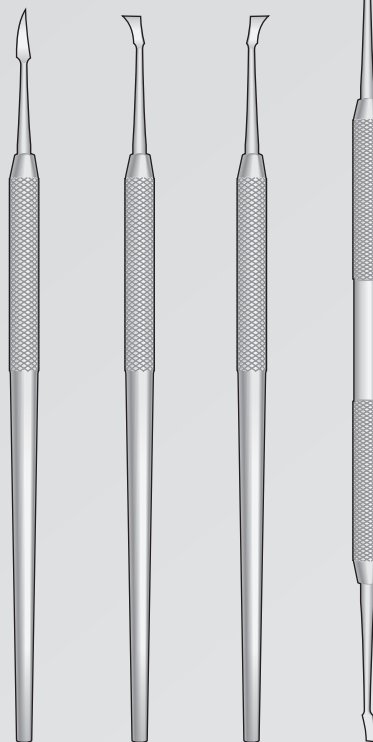

AT-1

AT-2R

AT-2L

AT-6

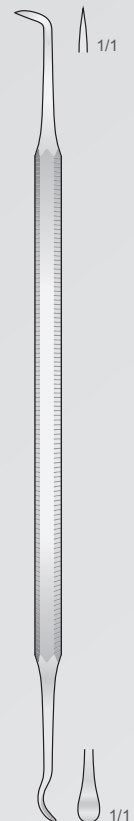

MITCHEL
AT-12
170 mm

Fig. 2/4

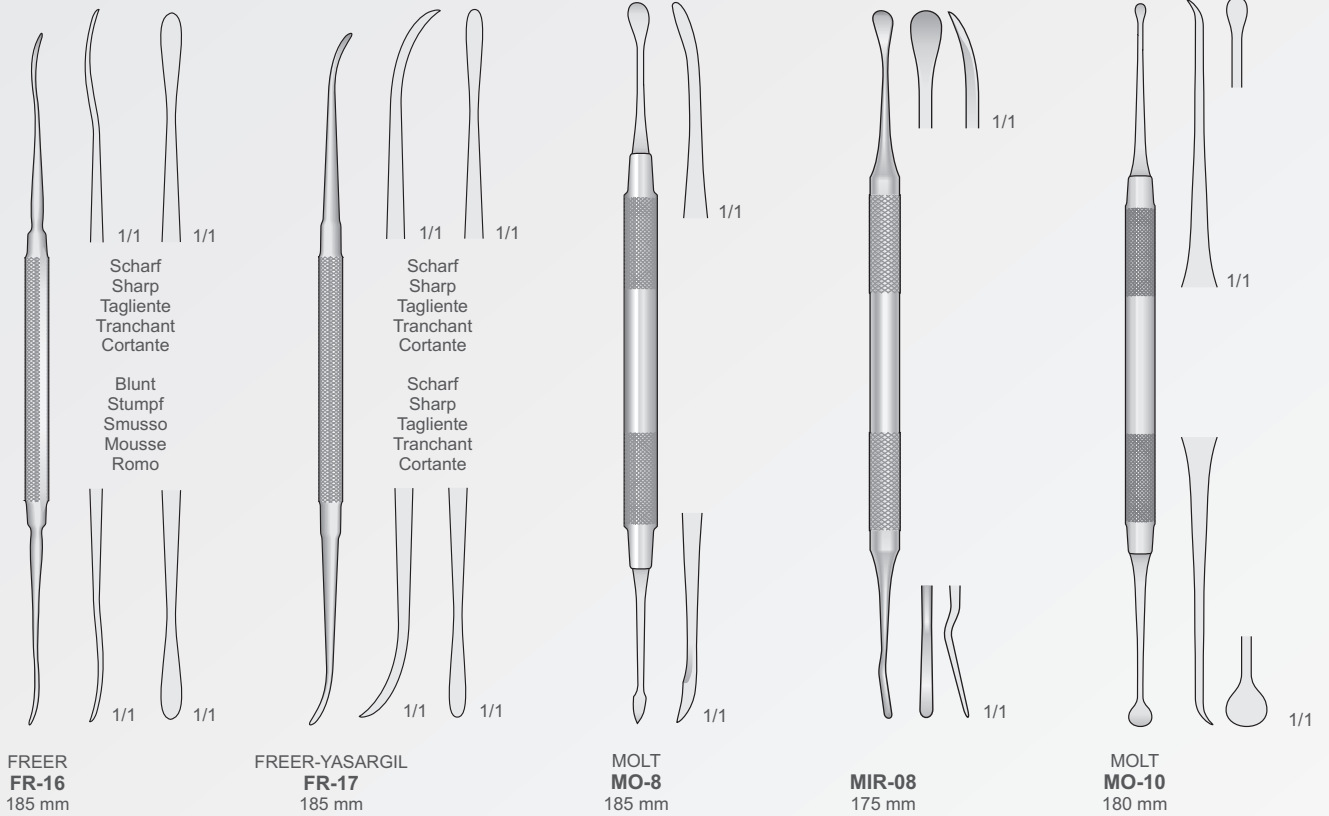

Bevel IN
Fig.1

Bevel OUT
Fig.2

4,5 mm

Fig. 67

Fig. 45

Fig. 52

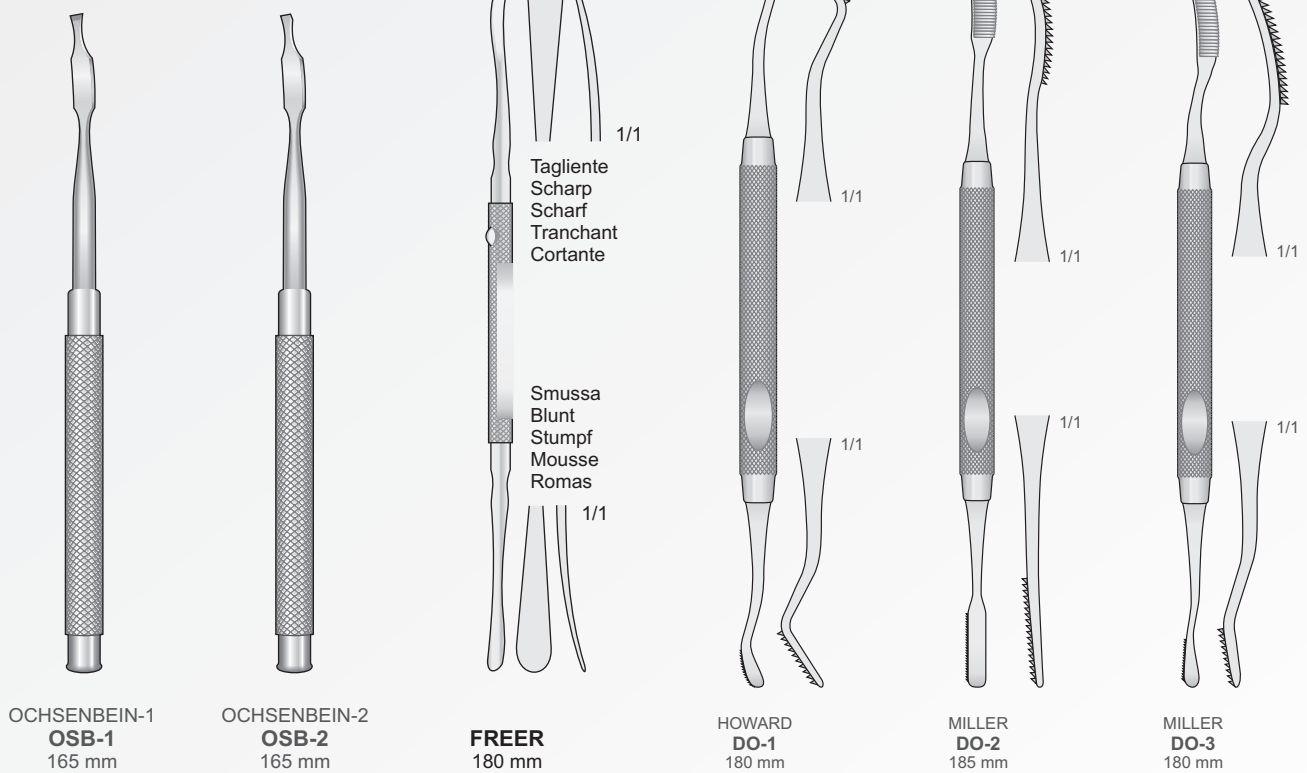

Zahnärztliche Chirurgie
Dental Surgery
Chirurgia Dentale
Cirugia dental
Chirurgie dentaire

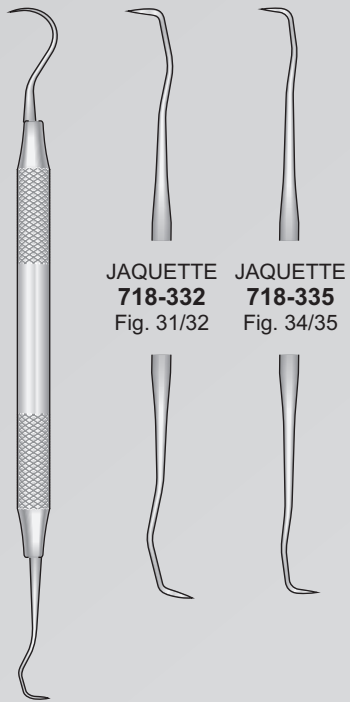

JAQUETTE **718-332** Fig. 31/32
JAQUETTE **718-335** Fig. 34/35

TOWNER-JAQUETTE
719-111
Fig. U15/33

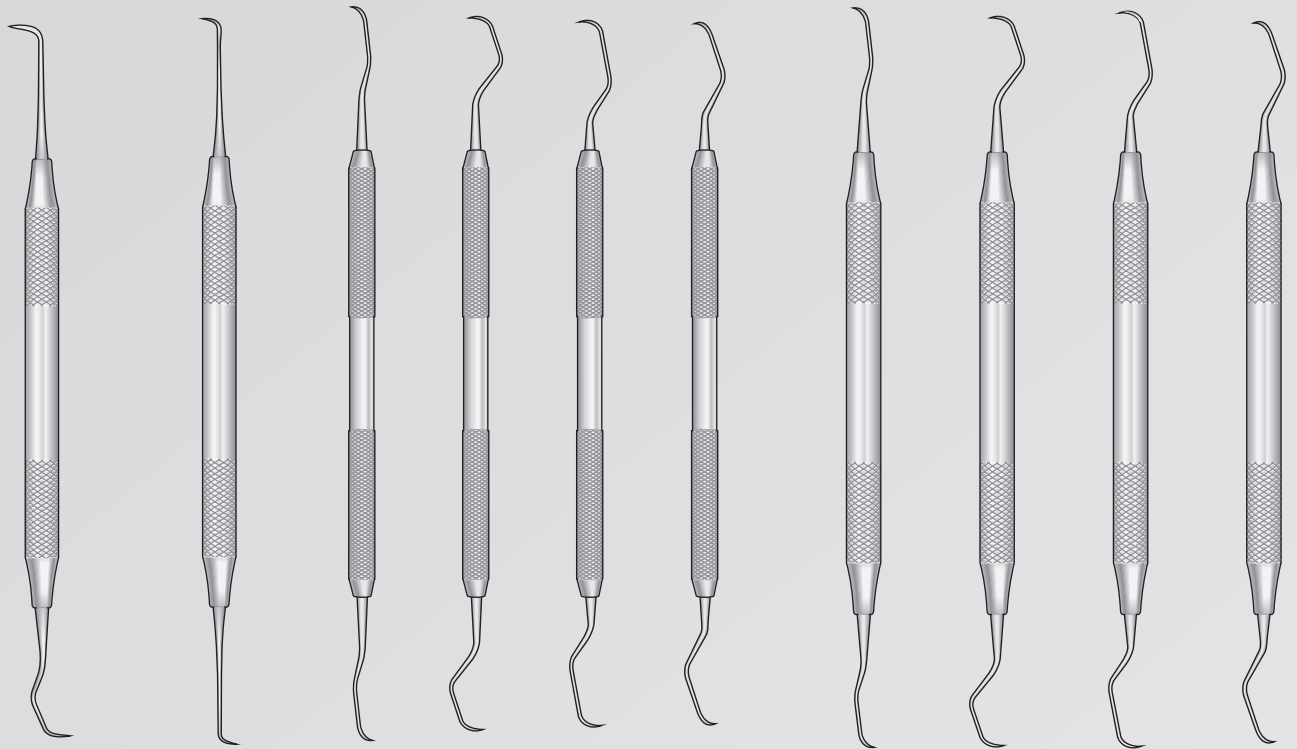

GOLDMAN-FOX **718-271** Fig. 1
GOLDMAN-FOX **718-277** Fig. 21
GRACEY **CU-1/2**
GRACEY **CU-3/4**
GRACEY **CU-5/6**
GRACEY **CU-7/8**
GRACEY **718-1/2**
GRACEY **718-3/4**
GRACEY **718-5/6**
GRACEY **718-7/8**

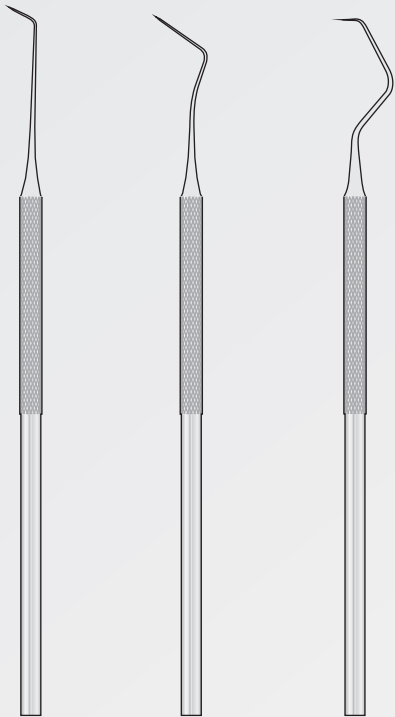

SO-3
Fig. 6

SO-4
Fig. 9

SO-10
Fig. 17A

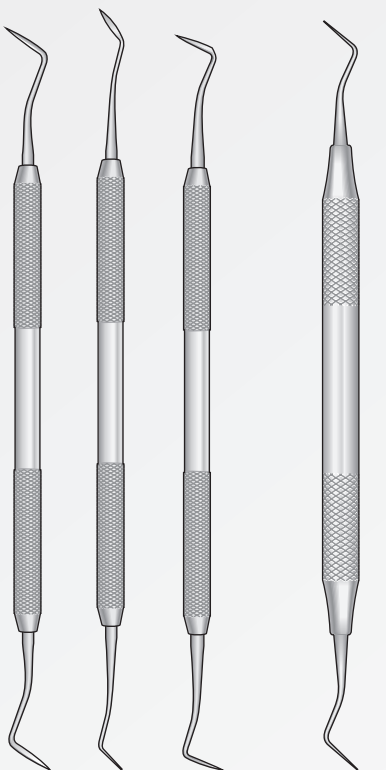

R-1

R-2

R-3

HOLLENBACK
715-101

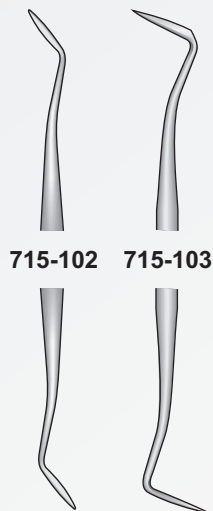

715-102

715-103



WILLIAMS
SM-1

MERRIT B
SM-3

GOLDMAN-FOX
SM-4

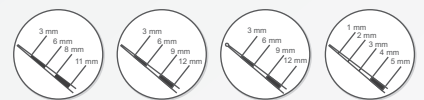

Flach
Flat
Piatta

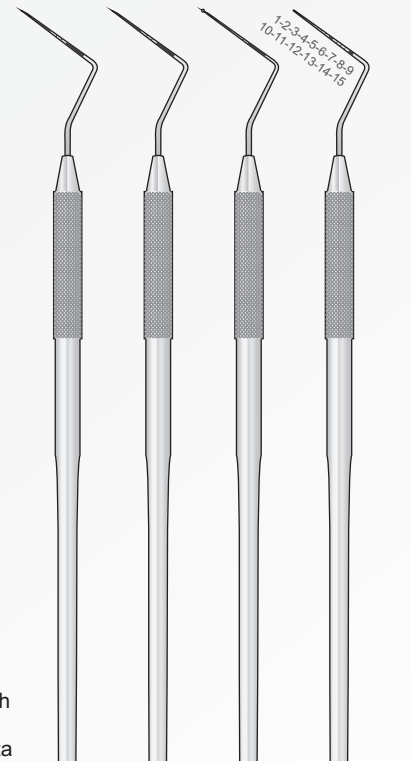

CP-11
SM-11
160 mm

CP-12
SM-12
160 mm

CP-12S
SM-13
160 mm

CP-15UNC
SM-15
160 mm

Zahnärztliche Chirurgie
Dental Surgery
Chirurgia Dentale
Cirugia dental
Chirurgie dentaire

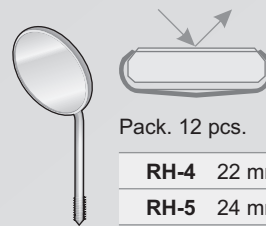

Pack. 12 pcs.

| | |
|-------------|-------|
| RH-4 | 22 mm |
| RH-5 | 24 mm |

Rhodiumspiegel
Rhodium Mirror
Specchietto rodiato
Espejo de rodio
Miroir au rhodium



Massiv
Solid
Pieno
Sólido
Massif

Rostfrei
Stainless
Inox
Inoxidable
Inoxydable

MA-1
120 mm



Massiv
Solid
Pieno
Sólido
Massif

Rostfrei
Stainless
Inox
Inoxidable
Inoxydable

MA-2
125 mm



Hohl
Hollow
Vuoto
Hueco
Creux

Rostfrei
Stainless
Inox
Inoxidable
Inoxydable

MA-3
125 mm



Pack. 12 pcs.

| | |
|------------|-------|
| P-3 | 18 mm |
| P-4 | 22 mm |
| P-5 | 24 mm |

Plan
Plane
Piano
Planos
Plans



Pack. 12 pcs.

| | |
|------------|-------|
| G-3 | 18 mm |
| G-4 | 22 mm |
| G-5 | 24 mm |

Hohl-Vergrößernd
Concave with enlarging effect
Concavo con ingrandimento
Còncavo con efecto de aumento
Creux avec effect agrandissant



BONTEMPI
CHIRURGISCHE INSTRUMENTE

Chirurgische Instrumente für große Tiere
Surgical Instruments for big animals
Strumenti chirurgici per grandi animali
Instrumentos Quirúrgicos para animales grandes
Instruments chirurgicaux pour les grands animaux

Sheren
Scissors
Forbici
Tijeras
Ciseaux

Strickanalschere
Teat Sitting Scissors
Forbice a doppio taglio
Tijera de doble filo
Ciseaux à double tranchant



VH-14
155 mm

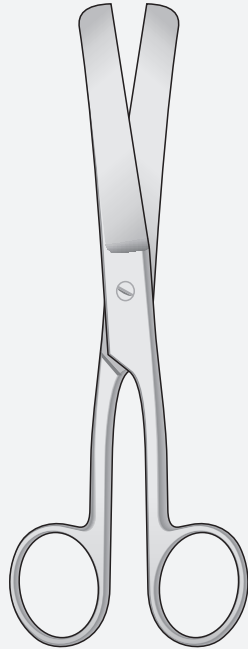

VH-15
170 mm



VH-18
160 mm

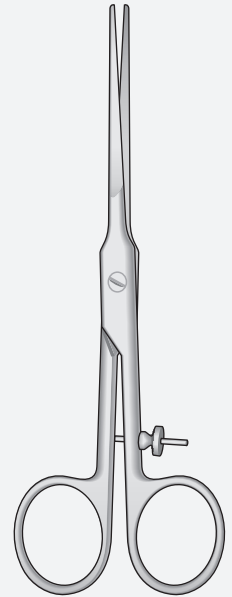

CHRESTENSEN
VH-10
155 mm

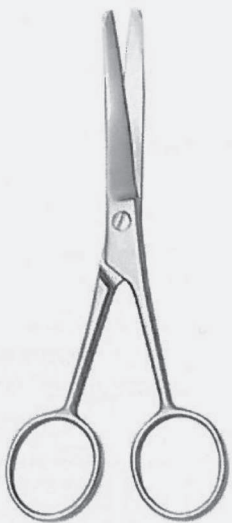

VH-26
135 mm



VH-24
170 mm



VH-12
160 mm

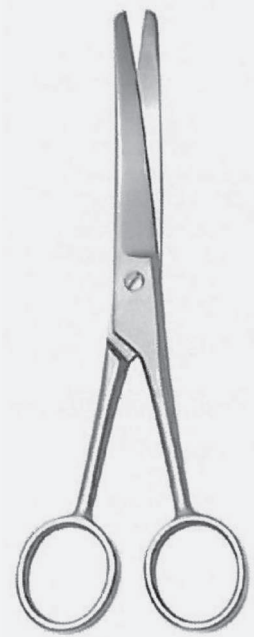

VH-28
160 mm

Haltevorrichtung
Restraining Equipment
Attrezzature per contenimento
Dispositivo de anclaje
Equipement de retenue

Bull Holders

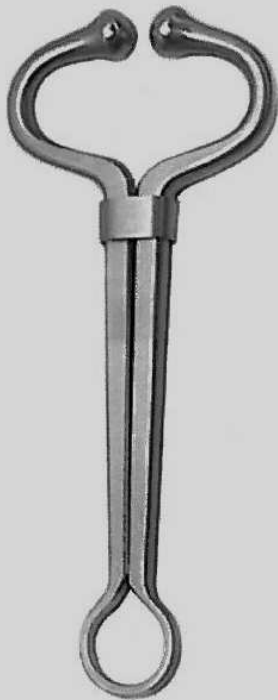

HARMS
VF-38
200 mm

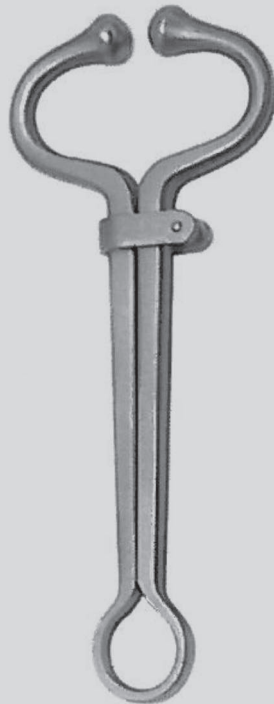

HARMS
VF-39
200 mm

Pig Ring Applicator

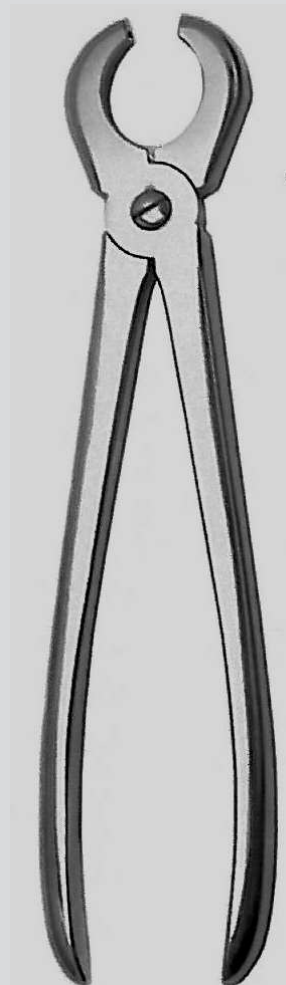

VF-25
265 mm

Pig Ring



VF-26
Ø 28 mm

Haltevorrichtung
Restraining Equipment
Attrezzature per contenimento
Dispositivo de anclaje
Equipement de retenue



VF-28
Ø 58 mm



VF-37
Ø 51 mm

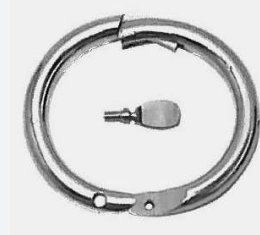

VF-29
Ø 58 mm

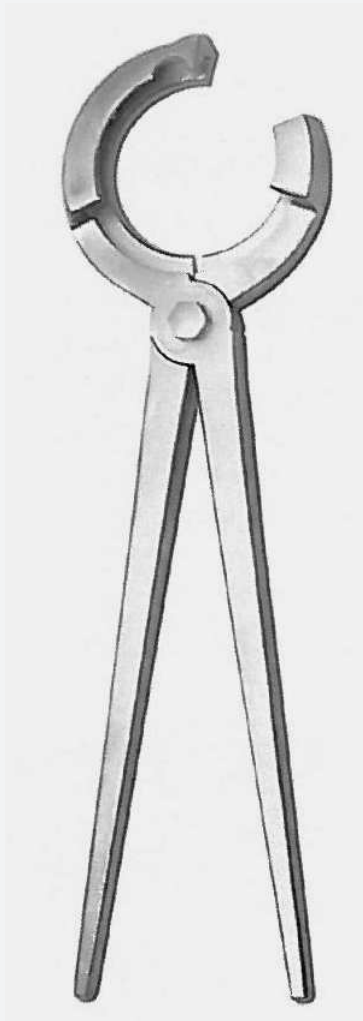

VF-32
320 mm

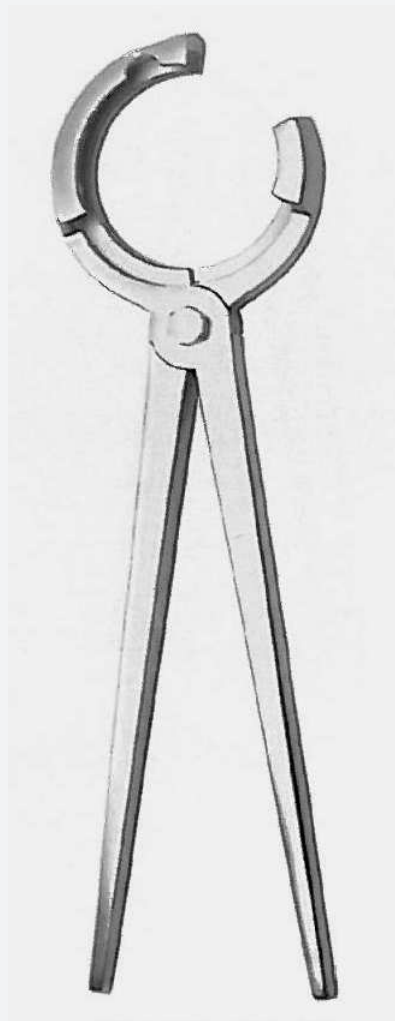

VF-50
320 mm

Instrumente für große Tiere
Instruments for big animals
Strumenti per grandi animali
Instrumentos para animales grandes
Instruments pour les grands animaux

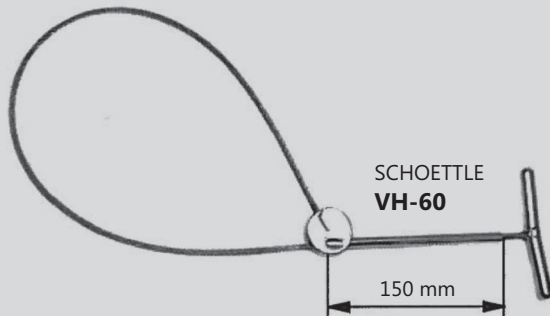
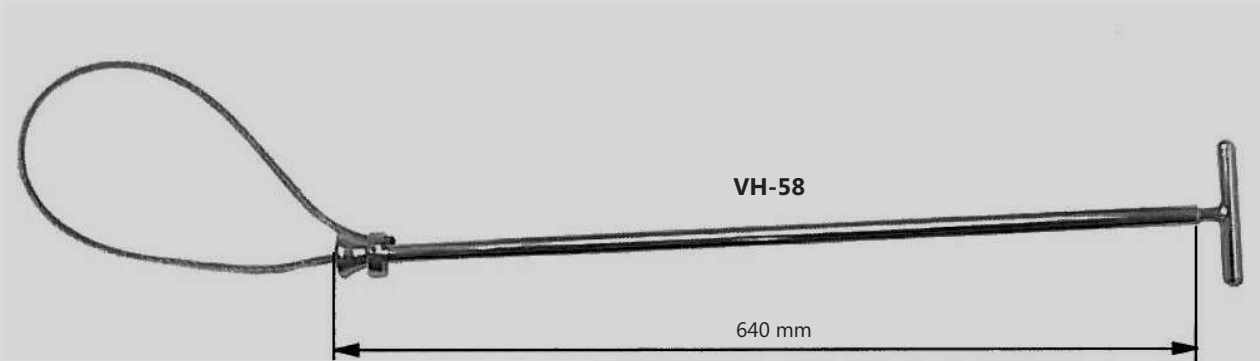

Apribocca per grandi animali

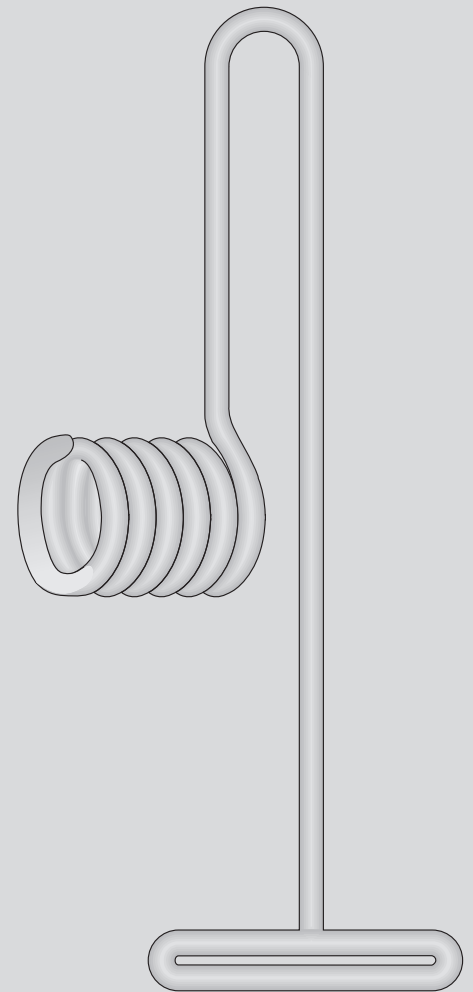

Augenkanüle für Pferde
Eye Cannula for Horses
Cannula lacrimale per cavalli
Cánula lagrimal para caballos
Canule lacrymale pour les chevaux

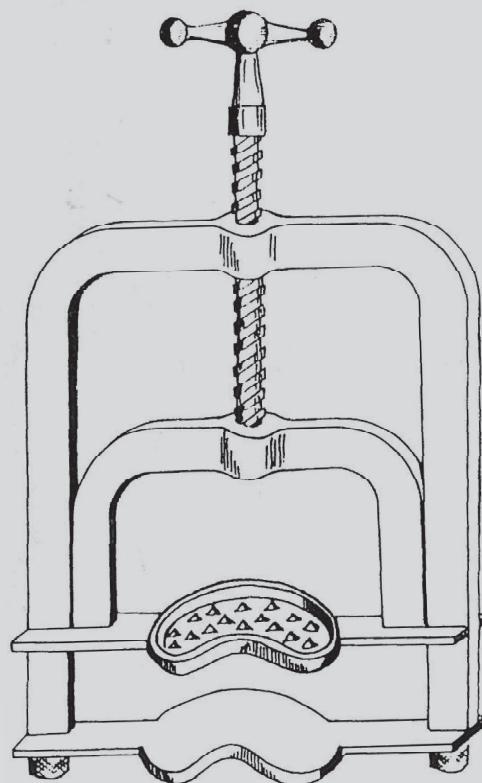

Zahn-Instrumente
Tooth Instruments
Raspe per denti
Raspadores para dientes
Râpes pour dents

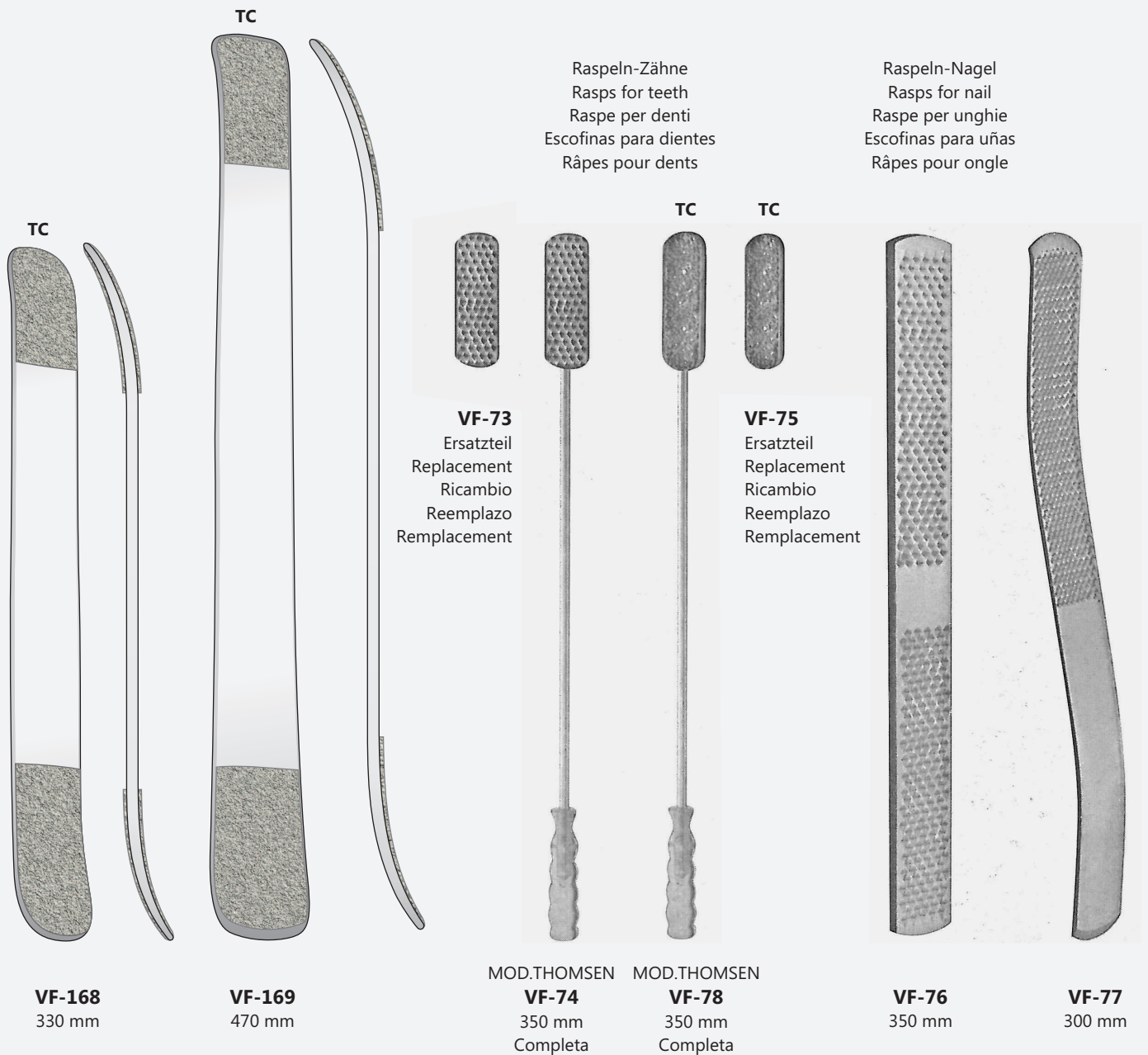

Castration Forceps
Emasculatori

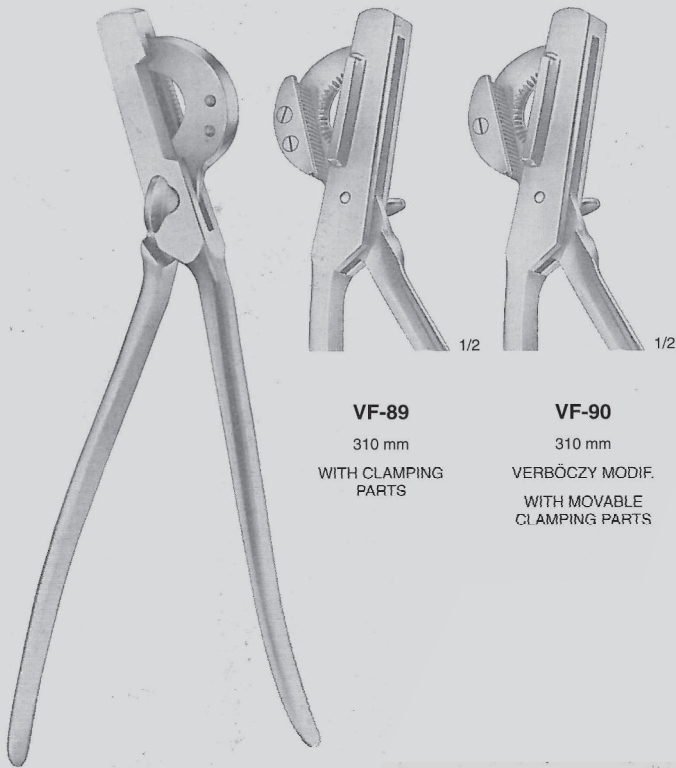

VF-89
310 mm
WITH CLAMPING
PARTS

VF-90
310 mm
VERBÖCZY MODIF.
WITH MOVABLE
CLAMPING PARTS

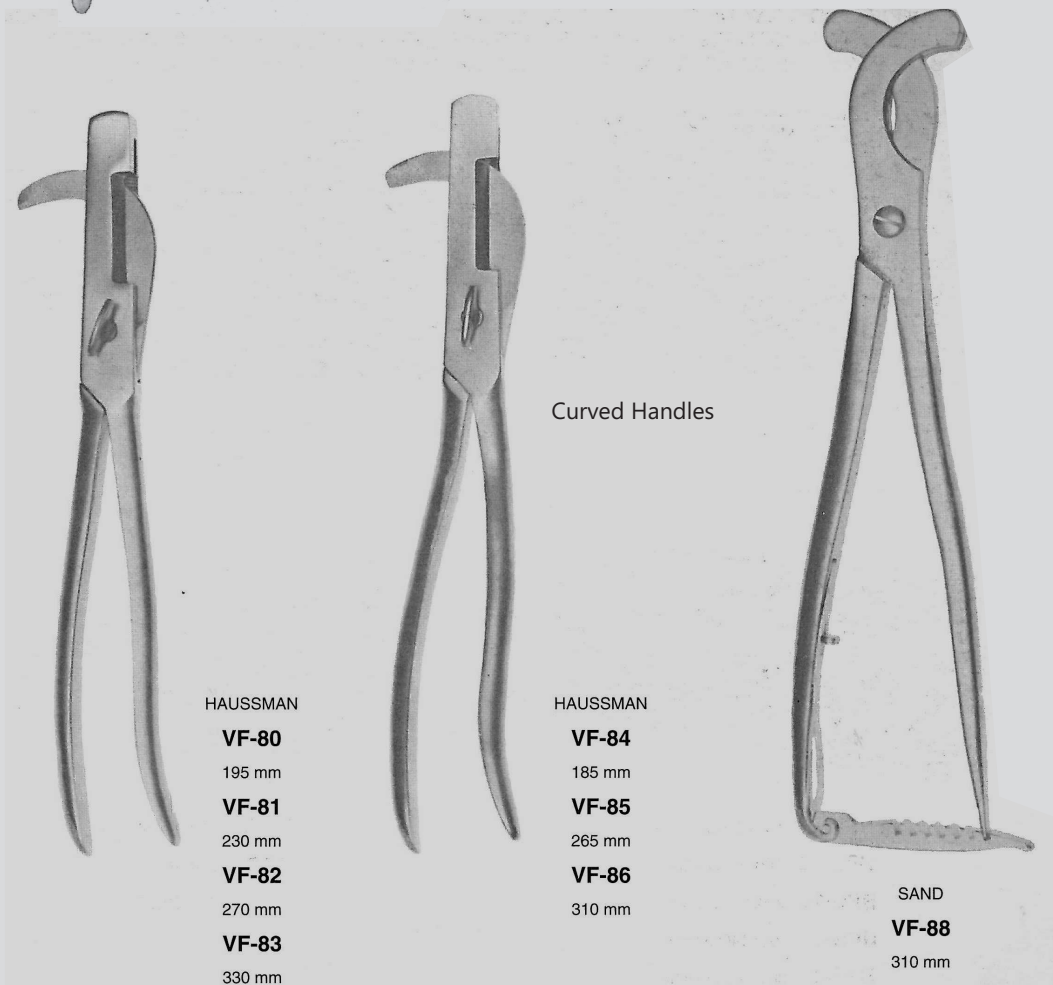

HAUSSMAN
VF-80
195 mm
VF-81
230 mm
VF-82
270 mm
VF-83
330 mm

HAUSSMAN
VF-84
185 mm
VF-85
265 mm
VF-86
310 mm

SAND
VF-88
310 mm

Curved Handles



VF-55

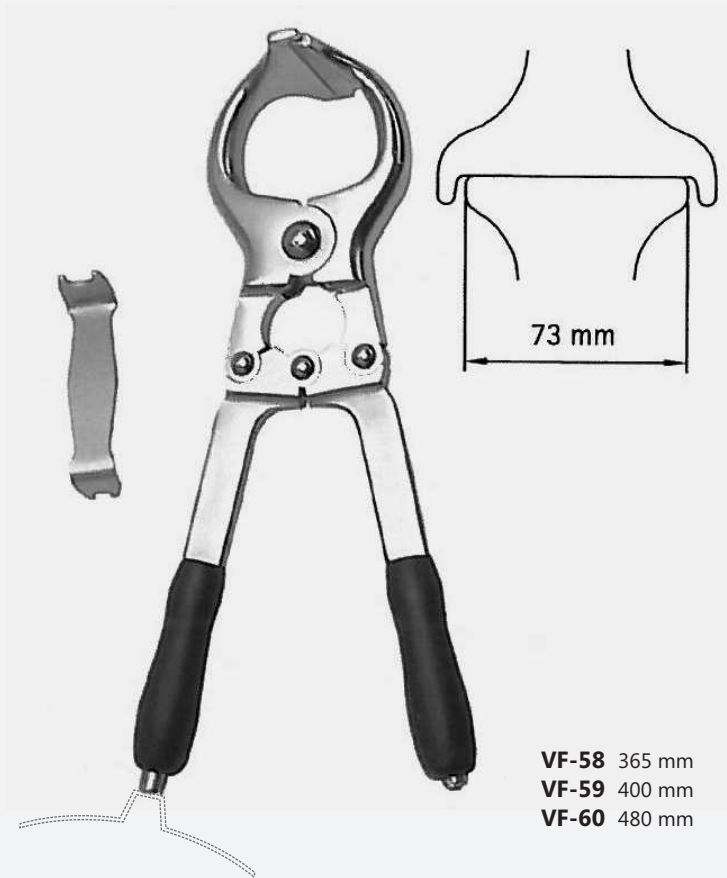

VF-58 365 mm
VF-59 400 mm
VF-60 480 mm

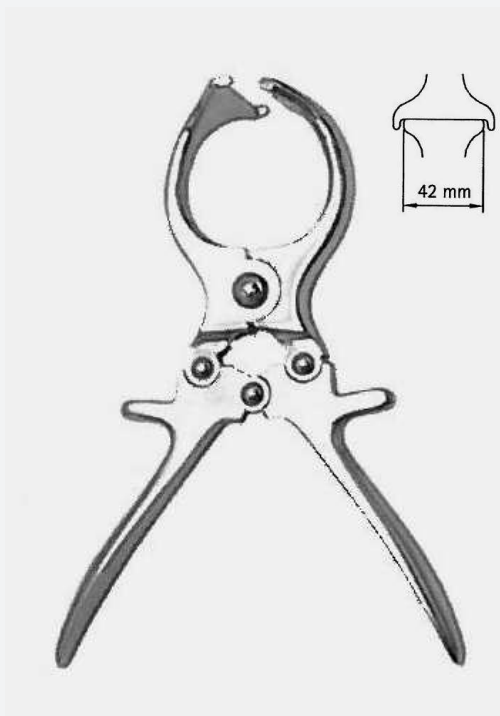

VF-56
230 mm



VF-57
300 mm

Hufinstrumente
Hoof Testing Forceps
Tenaglie per test zoccoli
Forceps para casco
Pinces Hoof

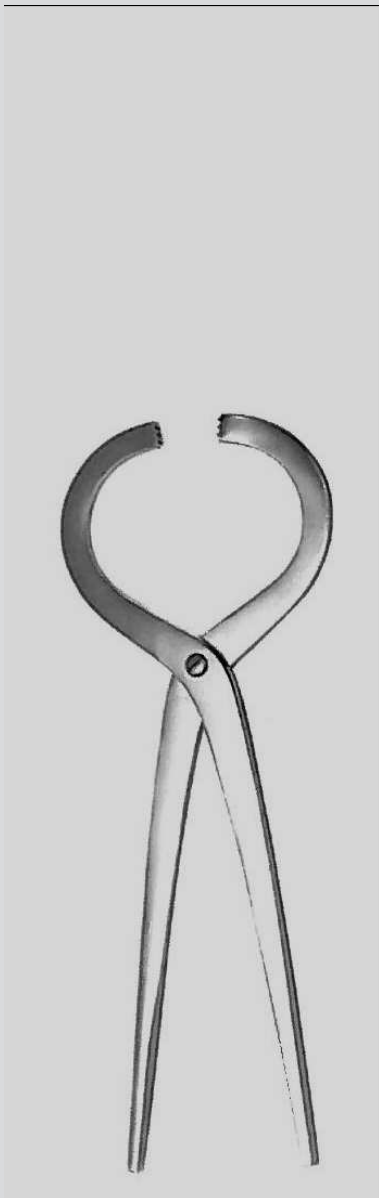

VF-16
300 mm

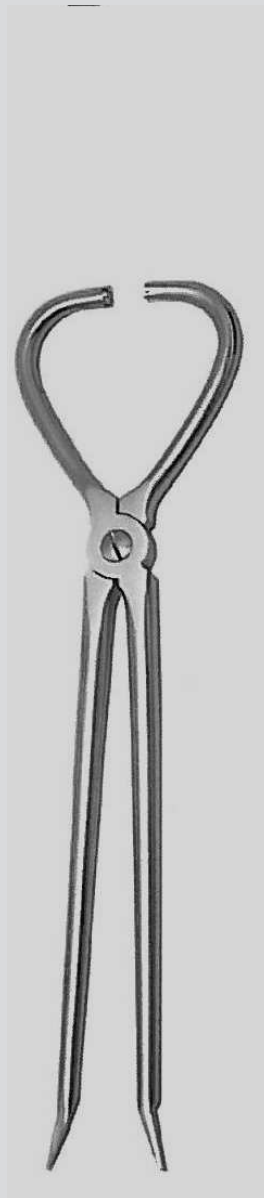

VF-17
380 mm

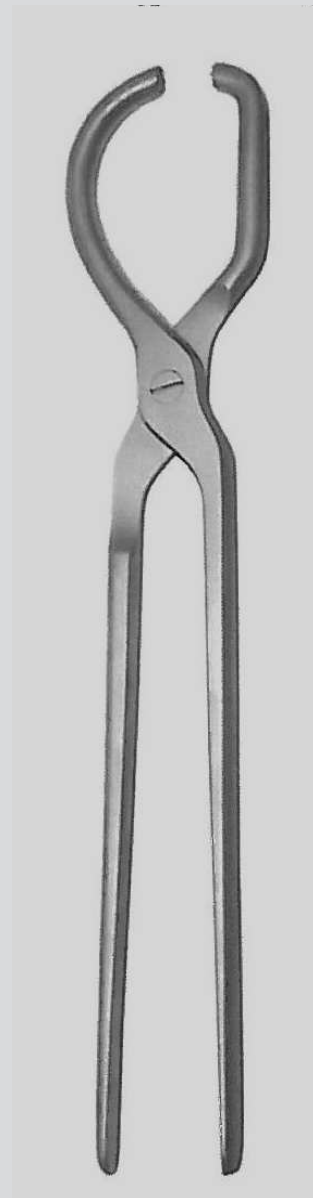

VF-15
405 mm

Hufmesser mit Holzgriff
Hoof knives with wooden handle
Coltelli per zoccoli con manico in legno
Cuchillos para casco con mango de madera
Couteaux sabot avec manche en bois

Holzgriff
Wooden Handle
Manico in legno
Mango de madera
Manche en bois



200 mm

Rechts
Right
Destra
Derecha
Droit

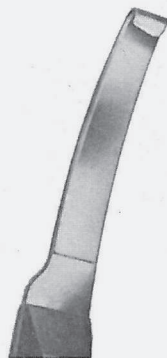

VF-201

Rechts
Right
Destra
Derecha
Droit



VF-202

Links
Left
Sinistra
Izquierda
Gauche

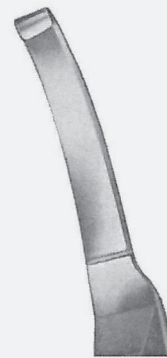

VF-203

Links
Left
Sinistra
Izquierda
Gauche

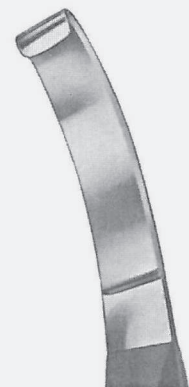

VF-204

Doppelschneidig
Double Cutting
Doppio taglio
Filo doble
Double Coupe



VF-207

Doppelschneidig
Double Cutting
Doppio taglio
Filo doble
Double Coupe



VF-208

Doppelschneidig
Double Cutting
Doppio taglio
Filo doble
Double Coupe



VF-209

Instrumente für Fremdkörperoperation
Instruments for stomach
Divaricatori per stomaco
Instrumentos para estómago
Instruments pour estomac

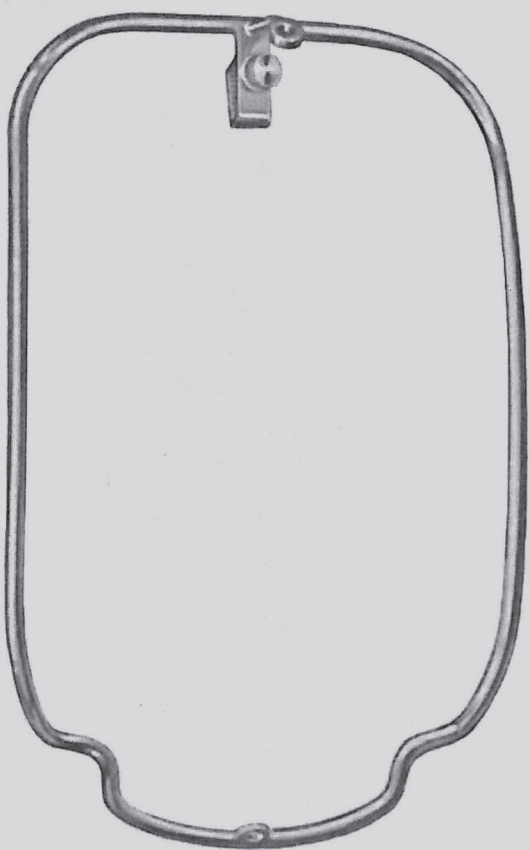

WEINGART
VF-95
280 mm

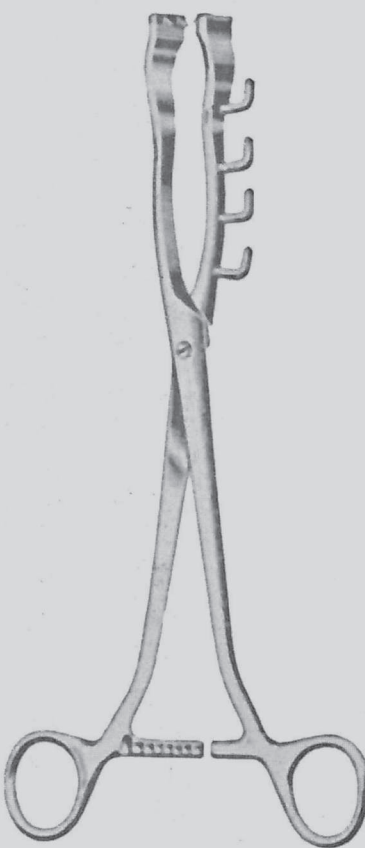

WEINGART
VF-97
240 mm

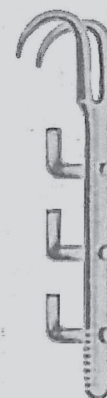

WEINGART
VF-99
80 mm

VF-100
SET COMPLETO DI: N° 1 VF-95
N° 1 VF-97
N° 8 VF-99

VF-100
KIT COMPLET: N° 1 VF-95
N° 1 VF-97
N° 8 VF-99

Hakenzangen
Uterine Forceps
Pinze uterine
Pinzas para útero
Pincas utérine

NICKELPLATED

PINZA UTERINA
VULSELUUM FORCEPS

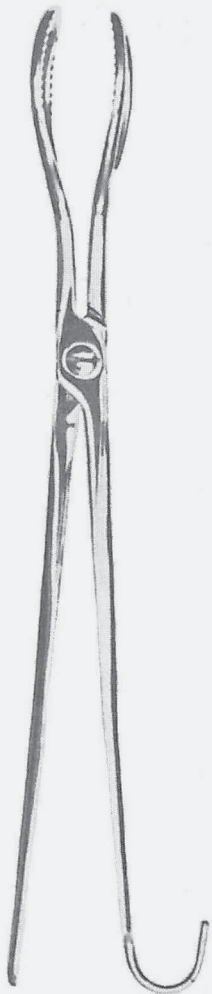

WITT-GERTH
VF-92
450 mm

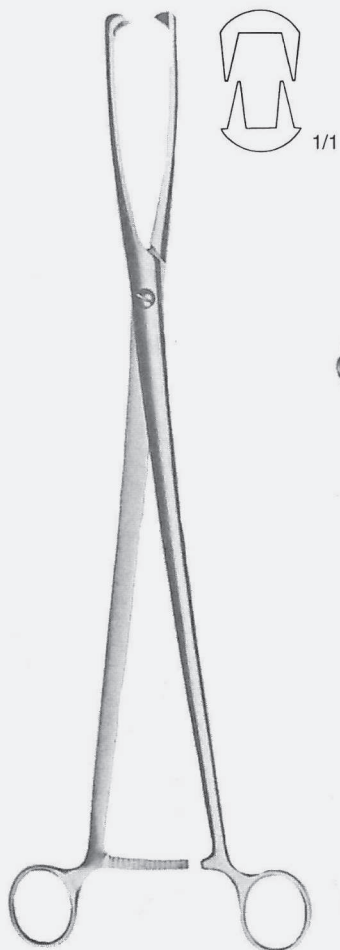

ALBRECHTSEN
VF-94
430 mm

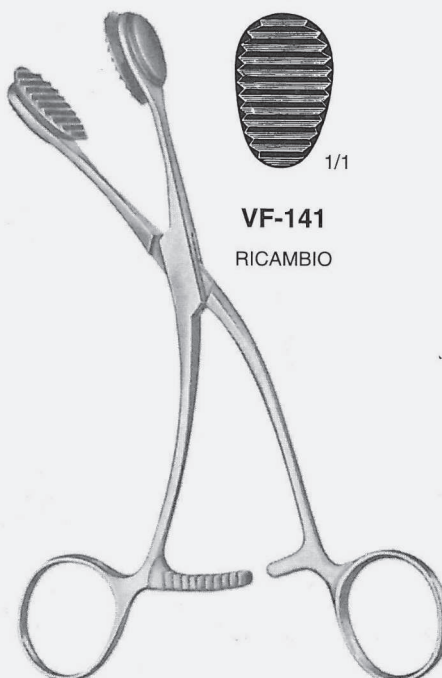

RICAMBIO GOMMINI
2 PEZZI
1 PAAR ERSATZGUMMI
1 PAIR OF RUBBER PADS

VF-140
RICAMBIO

YOUNG
VF-140
280 mm

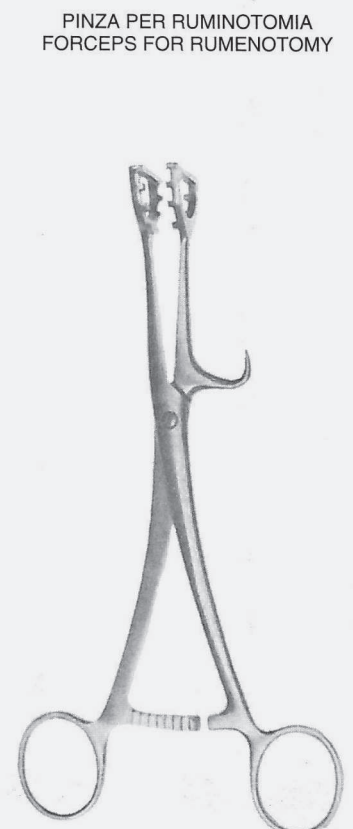

PINZA PER RUMINOTOMIA
FORCEPS FOR RUMENOTOMY

BLERNDINGER
VF-96
195 mm

Instrumente zur Geburtshilfe
Obstetric Instruments
Strumenti per parto
Instrumentos para obstetricia
Instruments pour l'accouchement

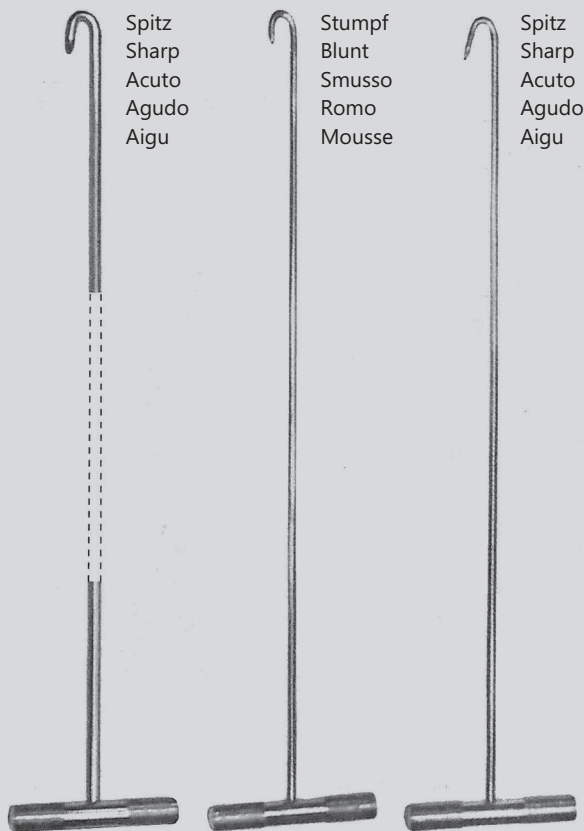

Spitz
Sharp
Acuto
Agudo
Aigu

Stumpf
Blunt
Smusso
Romo
Mousse

Spitz
Sharp
Acuto
Agudo
Aigu

VF-115
800 mm

VF-119
440 mm

VF-118
440 mm

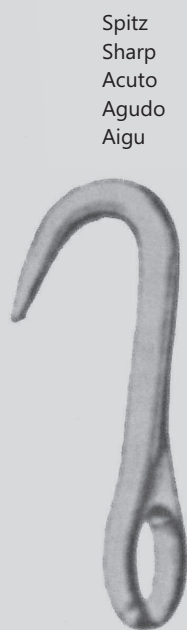

Spitz
Sharp
Acuto
Agudo
Aigu

HARMS
VF-71
80 mm

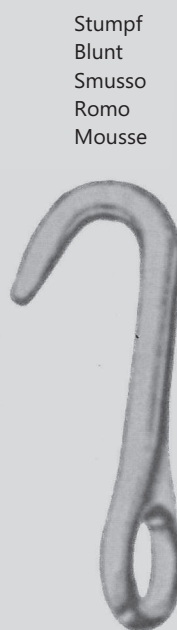

Stumpf
Blunt
Smusso
Romo
Mousse

HARMS
VF-72
80 mm

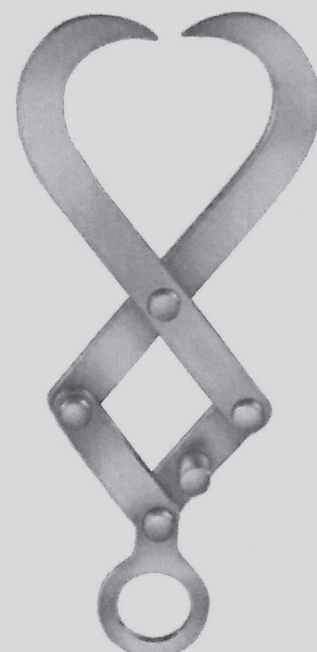

Haken mit 4 Verbindungen für Rückzug Totgeburt
Hook with 4 joints for withdrawal stillbirth
Gancio a 4 snodi per prelevamento feto morto
Crochet avec 4 joints pour retrait de mortinatalité
Gancho con 4 articulaciones para retirada muerte fetal

KREY SCHÖTTLER
VF-70
210 mm

Scheidenspekula
Vaginal Speculum
Speculum vaginali
Espéculos vaginales
Spéculum vaginaux

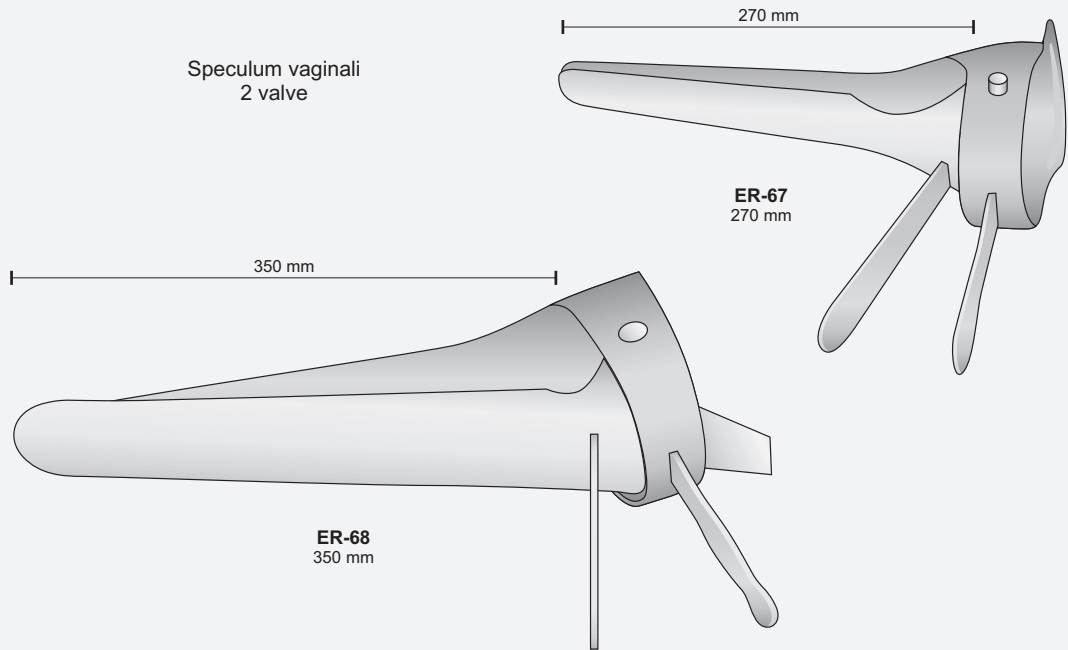

Speculum vaginale 3 valve per grandi animali
Inox

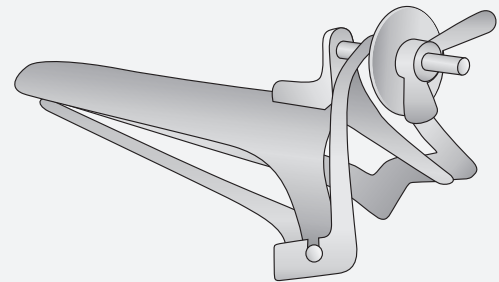

POLANSKY
ER-69
270 mm

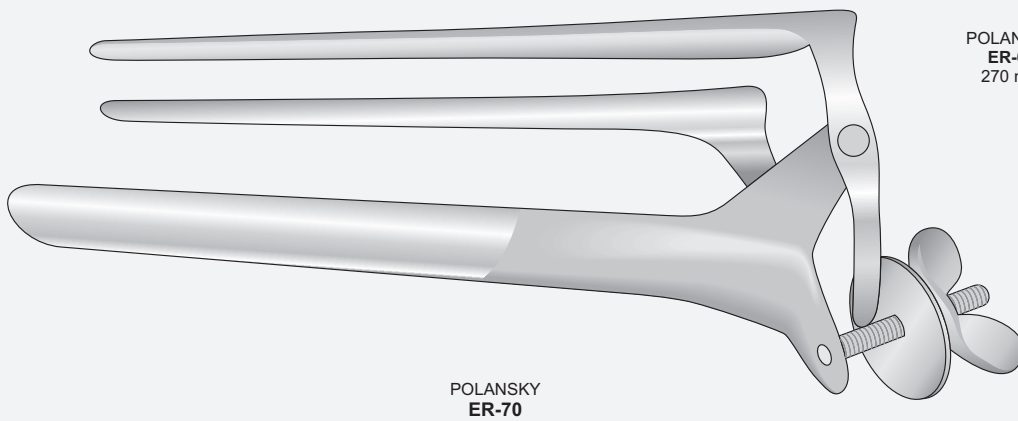

Instrumente zur Geburtshilfe
Obstetric Instruments
Strumenti per parto
Instrumentos para obstetricia
Instruments pour l'accouchement

STRUMENTI PER OSTETRICIA
SCHLINGENFÜHRER EMBRYOTOMY
WIRE & ROPE CARRIERS
OBSTETRIC INSTRUMENTS
INSTRUMENTOS PARA OBSTETRICIA



SAND
VF-47
190 mm

LEICHTES MODELL
LIGHT MODEL



SAND
VF-48
190 mm

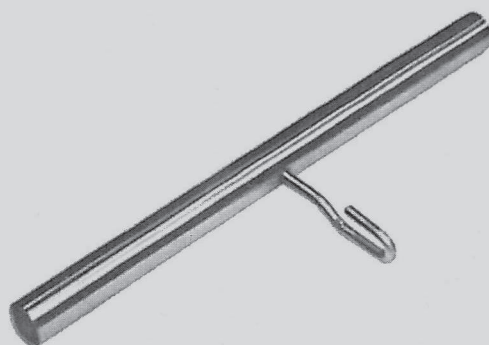

VF-69
250 mm

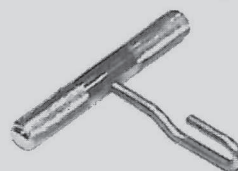

VF-68
100 mm

Instrumente zur Geburtshilfe
Obstetric Instruments
Strumenti per parto
Instrumentos para obstetricia
Instruments pour l'accouchement

With one blade serrated

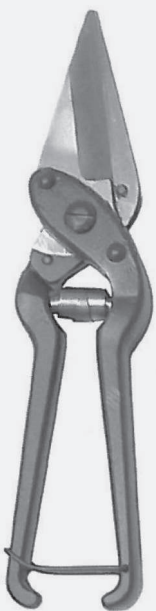

VH-30
240 mm

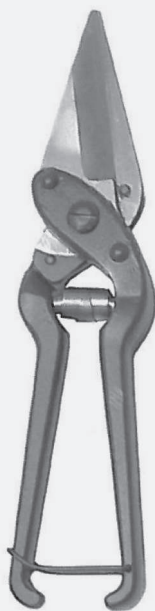

VH-31
240 mm

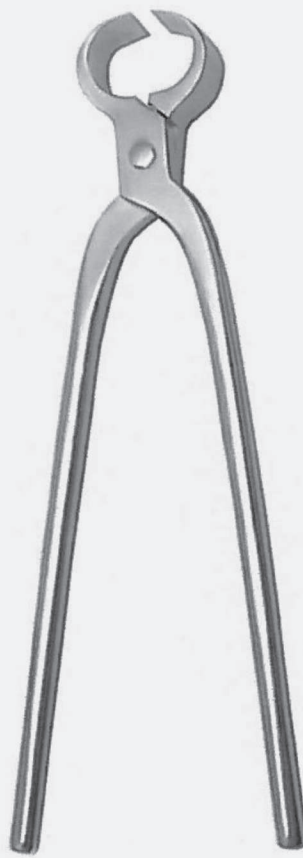

FRANK
VH-32
400 mm

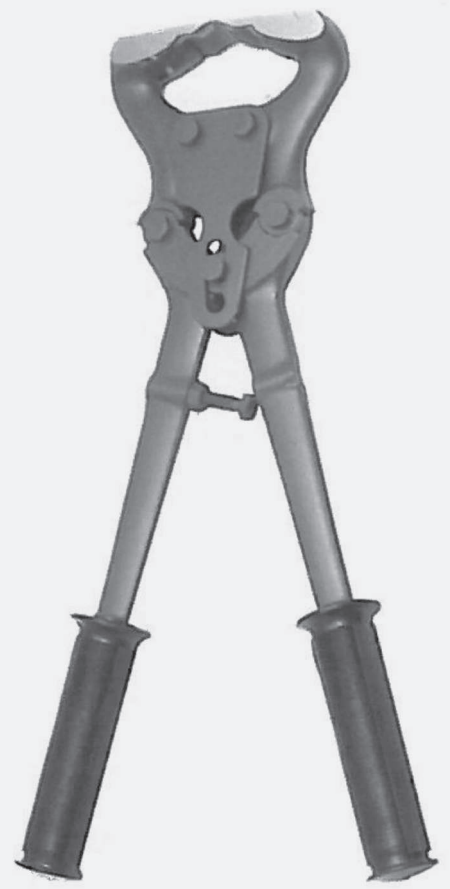

VF-52
420 mm

Dosierspritzen
Dosing Syringe
Siringhe per dosaggi
Jeringas dosificadoras
Seringues pour des doses

E' GARANTITO L'ESATTO DOSAGGIO.
OGNI MOVIMENTO DEL PUNTO INTERMEDIO A VOLUME E' DI 0,1 ML.
EXACT DOSAGE IS GUARANTEED.
EVERY MOVEMENT OF THE LEVER MEANS A VOLUME OF 0,1 ML.

TBC



JECT TBC
SV-21

UNI-MATIC
AUTOMATIC

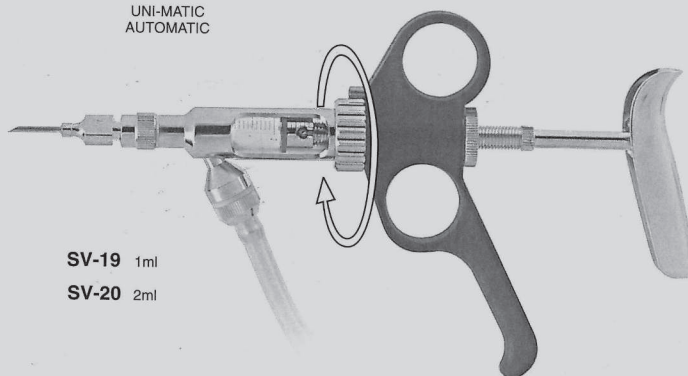

SV-19 1ml

SV-20 2ml

DRENCH-MATIC 20

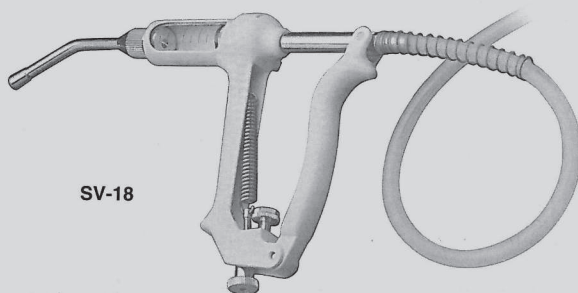

SV-18

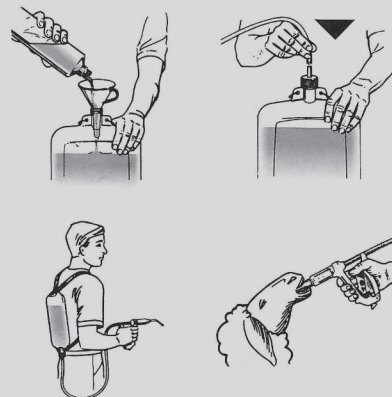

SV-18 Completo di sacca di plastica 2,5 lt.

SV-18S Accessorio sacca di plastica 2,5 lt.

Forbici per dissezione
Dissecting Scissors
Präparierscheren
Ciseaux à dissection
Tijeras para preparaciones

ROUX-REVOLVER

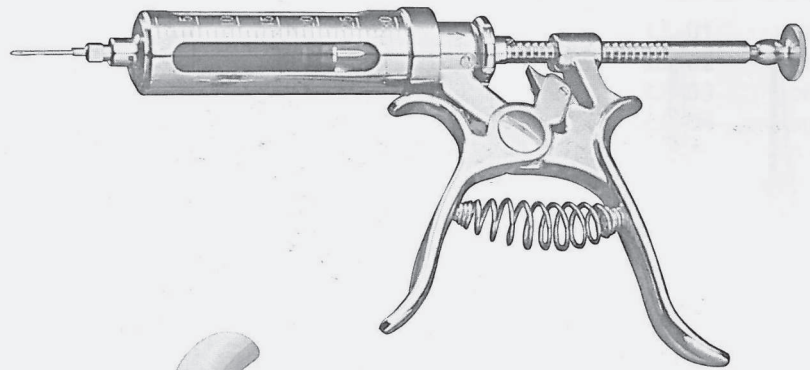

SV-11 10 ML

SV-12 30 ML

SV-13 50 ML

VET-MATIC M/91

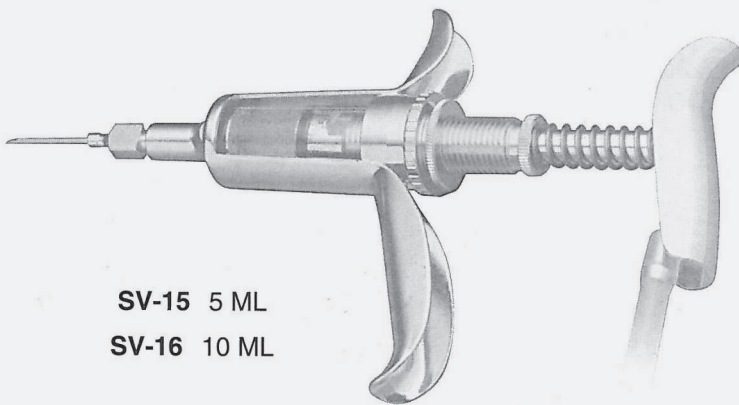

SV-15 5 ML

SV-16 10 ML

50 ML

ROUX-REVOLVER 50 ML CON PROLUNGA



SV-14
650 mm

SV-24
1000 mm

Kanülen Boxen
Needle Luer-Lock
Aghi Luer-Lock
Aguja Luer-Lock
Aguilles Luer-Lock

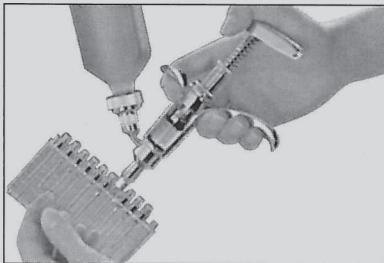
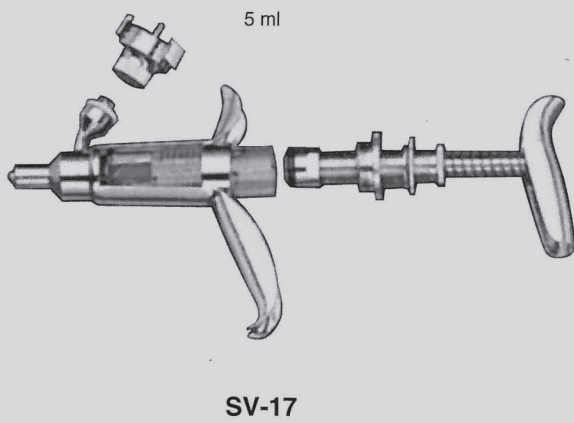

"PREMIUM"

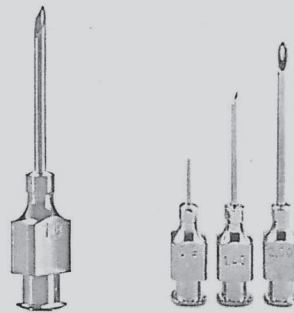

CONO LUER-LOOK

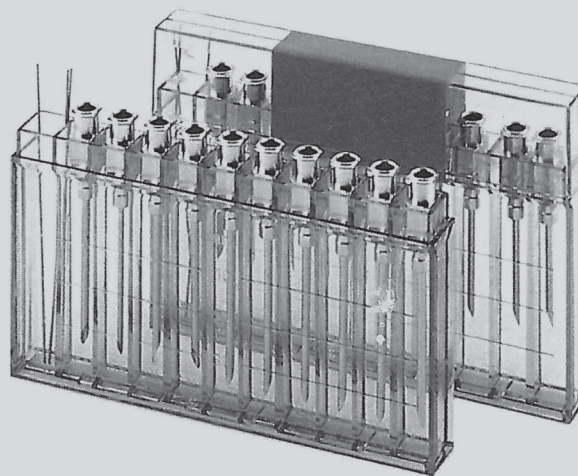

CONFEZIONE 10 PEZZI

MISURA - AGO
MASS - NADEL
MEASURE - NEEDLE
MEDIDA - AGUJA

| | |
|--------------|---------|
| LL-01 | 0,80x10 |
| LL-02 | 0,80x25 |
| LL-03 | 0,90x10 |
| LL-04 | 0,90x15 |
| LL-05 | 0,90x20 |
| LL-06 | 0,90x25 |
| LL-07 | 0,90x35 |
| LL-08 | 100x10 |
| LL-09 | 100x15 |
| LL-10 | 100x20 |
| LL-11 | 120x15 |
| LL-12 | 120x20 |
| LL-13 | 120x25 |
| LL-14 | 140x15 |
| LL-15 | 140x20 |
| LL-16 | 140x25 |
| LL-17 | 140x35 |
| LL-18 | 160x15 |
| LL-19 | 160x20 |
| LL-20 | 160x25 |
| LL-21 | 160x35 |
| LL-22 | 180x15 |
| LL-23 | 180x20 |
| LL-24 | 180x25 |
| LL-25 | 180x35 |
| LL-26 | 200x20 |
| LL-27 | 200x25 |
| LL-28 | 200x35 |
| LL-29 | 140x30 |
| LL-30 | 160x30 |
| LL-31 | 180x30 |
| LL-32 | 200x15 |
| LL-33 | 200x30 |
| LL-34 | 220x25 |
| LL-35 | 240x20 |
| LL-36 | 240x25 |
| LL-37 | 300x30 |

Emasculatori per grandi animali

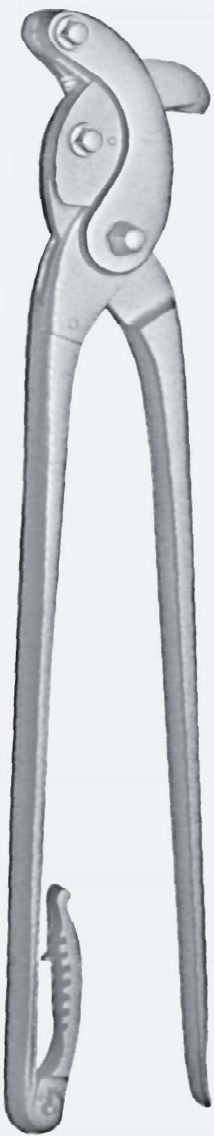

BERTSCHY
VF-300
360 mm



BERTSCHY MOD.
VF-301
350 mm

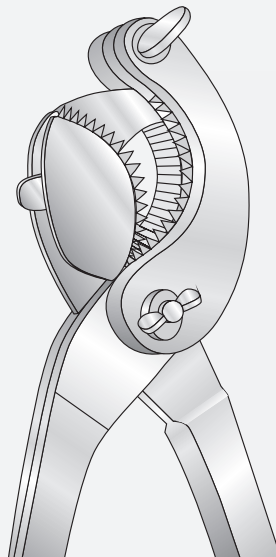

REIMERS
VF-302
310 mm

Ohr Instrumente
Ear Instruments
Taglia orecchie
Instrumentos auriculares
Instruments auriculaires

Punch per orecchio

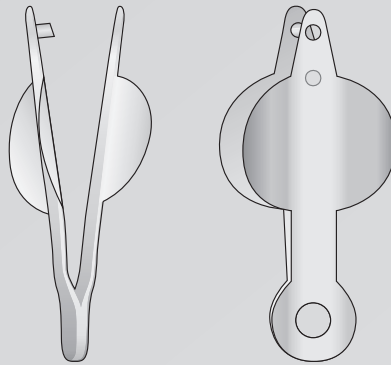

BD-150
50 mm

Lama ricambio

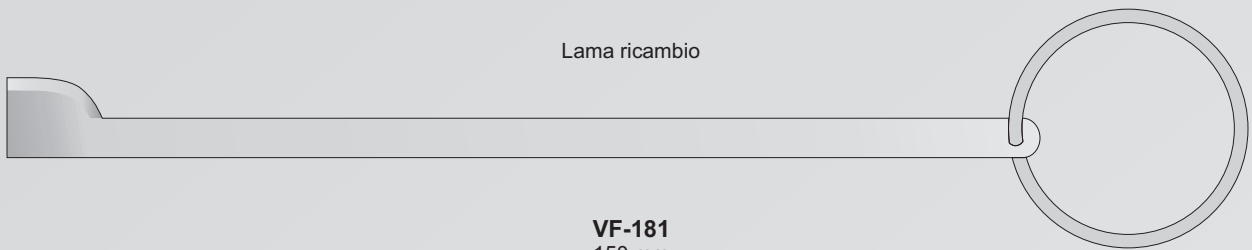

VF-181
150 mm

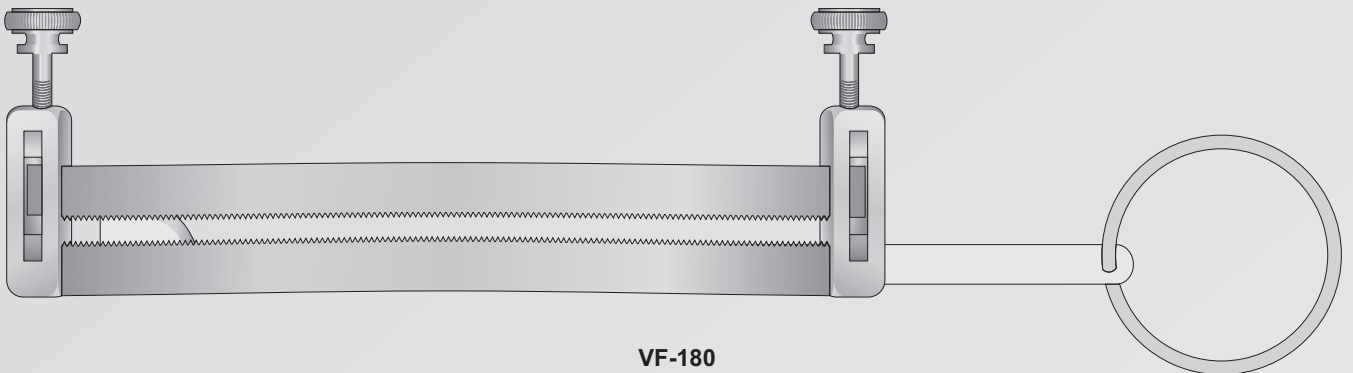

VF-180
130 mm



BONTEMPI
CHIRURGISCHE INSTRUMENTE

Nummernverzeichnis
Alphanumerical Index
Indice alfanumerico
Indice alfanumerico
Index alphanumérique

| | | | | | | | |
|----------|-----|---------|-----|--------|-----|--------|----|
| 1 | 333 | AA-S104 | 3 | BD-117 | 70 | BD-193 | 77 |
| 2 | 333 | AA-S105 | 3 | BD-118 | 70 | BD-194 | 63 |
| 7 | 333 | AA-S203 | 4 | BD-119 | 70 | BD-195 | 63 |
| 13 | 336 | AA-S204 | 4 | BD-120 | 61 | BD-196 | 63 |
| 29 | 334 | AA-S205 | 4 | BD-122 | 61 | BD-20 | 67 |
| 30 | 334 | AA-S253 | 6 | BD-123 | 61 | BD-200 | 61 |
| 33 | 336 | AA-S254 | 6 | BD-124 | 66 | BD-201 | 61 |
| 41 | 336 | AA-S255 | 6 | BD-126 | 66 | BD-202 | 61 |
| 48 | 337 | AA-S403 | 5 | BD-127 | 68 | BD-203 | 61 |
| 49 | 337 | AA-S404 | 5 | BD-128 | 69 | BD-21 | 73 |
| 51 | 335 | AA-S503 | 6 | BD-129 | 69 | BD-210 | 77 |
| 46L | 337 | AA-S504 | 6 | BD-130 | 295 | BD-211 | 77 |
| 51A | 335 | AA-S505 | 6 | BD-131 | 295 | BD-212 | 77 |
| | | | | BD-132 | 295 | BD-213 | 77 |
| 713-101 | 278 | AB-10 | 8 | BD-135 | 64 | BD-214 | 77 |
| 713-102 | 278 | AB-14 | 8 | BD-135 | 296 | BD-215 | 77 |
| 715-101 | 351 | AB-16 | 8 | BD-136 | 64 | BD-216 | 75 |
| 715-102 | 351 | AB-18 | 8 | BD-136 | 296 | BD-217 | 75 |
| 715-103 | 351 | AB-41 | 7 | BD-137 | 69 | BD-22 | 77 |
| 717-100 | 278 | AB-41R | 7 | BD-138 | 70 | BD-23 | 66 |
| 717-102 | 278 | AB-44R | 7 | BD-139 | 70 | BD-230 | 76 |
| 717-112 | 278 | AB-48 | 7 | BD-14 | 73 | BD-231 | 76 |
| 718-1/2 | 350 | AB-49 | 7 | BD-141 | 65 | BD-24 | 66 |
| 718-271 | 350 | AB-50 | 8 | BD-142 | 69 | BD-240 | 63 |
| 718-277 | 350 | | | BD-143 | 69 | BD-241 | 63 |
| 718-3/4 | 350 | AS-10 | 203 | BD-144 | 68 | BD-242 | 63 |
| 718-332 | 350 | AS-16 | 203 | BD-145 | 64 | BD-243 | 63 |
| 718-335 | 350 | AS-19 | 203 | BD-146 | 77 | BD-244 | 63 |
| 718-5/6 | 350 | AS-20 | 203 | BD-147 | 77 | BD-245 | 63 |
| 718-7/8 | 350 | AS-31 | 203 | BD-148 | 67 | BD-246 | 63 |
| 718-M23 | 348 | AS-35 | 203 | BD-149 | 70 | BD-247 | 63 |
| 718-M23A | 348 | AS-36 | 203 | BD-15 | 73 | BD-248 | 63 |
| 718-M23B | 348 | | | BD-150 | 72 | BD-249 | 63 |
| 719-111 | 350 | AT-1 | 348 | BD-150 | 374 | BD-25 | 66 |
| | | AT-12 | 348 | BD-151 | 72 | BD-250 | 76 |
| A-1 | 278 | AT-2L | 348 | BD-152 | 72 | BD-251 | 76 |
| | | AT-2R | 348 | BD-153 | 71 | BD-26 | 66 |
| | | AT-6 | 348 | BD-154 | 71 | BD-27 | 72 |
| AA-100 | 3 | | | BD-155 | 71 | BD-271 | 68 |
| AA-101 | 3 | | | BD-156 | 71 | BD-272 | 68 |
| AA-102 | 3 | BB-46 | 12 | BD-16 | 67 | BD-273 | 68 |
| AA-103 | 3 | BB-46 | 298 | BD-160 | 74 | BD-274 | 68 |
| AA-104 | 3 | BB-48 | 12 | BD-161 | 74 | BD-275 | 68 |
| AA-130 | 6 | | | BD-162 | 74 | BD-276 | 68 |
| AA-200 | 4 | BD-04 | 63 | BD-163 | 74 | BD-277 | 68 |
| AA-201 | 4 | BD-04 | 296 | BD-164 | 74 | BD-278 | 68 |
| AA-202 | 4 | BD-05 | 64 | BD-165 | 74 | BD-279 | 69 |
| AA-203 | 4 | BD-06 | 64 | BD-166 | 74 | BD-28 | 71 |
| AA-204 | 4 | BD-07 | 63 | BD-167 | 74 | BD-280 | 69 |
| AA-250 | 6 | BD-09 | 67 | BD-168 | 74 | BD-281 | 73 |
| AA-251 | 6 | BD-10 | 66 | BD-169 | 74 | BD-282 | 73 |
| AA-401 | 5 | BD-100 | 66 | BD-17 | 71 | BD-283 | 69 |
| AA-402 | 5 | BD-101 | 77 | BD-170 | 75 | BD-284 | 69 |
| AA-403 | 5 | BD-102 | 77 | BD-171 | 75 | BD-286 | 69 |
| AA-404 | 5 | BD-104 | 69 | BD-172 | 75 | BD-287 | 73 |
| AA-70 | 6 | BD-105 | 66 | BD-173 | 75 | BD-288 | 73 |
| AA-80 | 6 | BD-106 | 70 | BD-174 | 61 | BD-289 | 73 |
| AA-90H | 6 | BD-107 | 70 | BD-175 | 72 | BD-29 | 72 |
| AA-B100 | 3 | BD-108 | 70 | BD-176 | 72 | BD-290 | 73 |
| AA-B100 | 4 | BD-109 | 68 | BD-177 | 76 | BD-291 | 73 |
| AA-B100 | 5 | BD-110 | 68 | BD-178 | 76 | BD-292 | 73 |
| AA-B100 | 6 | BD-111 | 68 | BD-179 | 77 | BD-293 | 69 |
| AA-B101 | 3 | BD-112 | 68 | BD-18 | 67 | BD-294 | 69 |
| AA-B101 | 4 | BD-113 | 68 | BD-184 | 71 | BD-295 | 69 |
| AA-B101 | 5 | BD-114 | 68 | BD-185 | 71 | BD-30 | 65 |
| AA-B101 | 6 | BD-115 | 70 | BD-19 | 69 | BD-31 | 65 |
| AA-S103 | 3 | BD-116 | 70 | | | | |

Nummernverzeichnis
Alphanumerical Index
Indice alfanumerico
Indice alfanumerico
Index alphanumérique

| | | | | | | | |
|---------------|-----|----------------|-----|---------------|-----|---------------|-----|
| BD-32 | 62 | BD-72 | 65 | BF-48 | 96 | BT-05 | 166 |
| BD-32 | 295 | BD-73 | 65 | BF-64 | 58 | BT-06 | 166 |
| BD-33 | 62 | BD-74 | 66 | BF-65 | 58 | BT-07 | 166 |
| BD-33 | 295 | BD-75 | 66 | BF-68 | 58 | BT-1 | 139 |
| BD-34 | 62 | BD-76 | 66 | BF-69 | 58 | BT-10 | 293 |
| BD-35 | 62 | BD-78 | 66 | BF-78 | 95 | BT-101 | 143 |
| BD-35 | 295 | BD-79 | 66 | BF-79 | 95 | BT-102 | 143 |
| BD-351 | 75 | BD-80 | 74 | BF-82 | 96 | BT-103 | 143 |
| BD-352 | 75 | BD-81 | 74 | | | BT-104 | 143 |
| BD-353 | 75 | BD-82 | 74 | BM-01 | 130 | BT-105 | 143 |
| BD-354 | 75 | BD-83 | 74 | BM-02 | 130 | BT-106 | 143 |
| BD-355 | 75 | BD-84 | 74 | BM-03 | 130 | BT-107 | 143 |
| BD-356 | 75 | BD-85 | 74 | BM-04 | 130 | BT-108 | 143 |
| BD-36 | 62 | BD-86 | 74 | BM-10 | 121 | BT-141 | 143 |
| BD-36 | 295 | BD-87 | 74 | BM-11 | 121 | BT-142 | 143 |
| BD-37 | 72 | BD-88 | 74 | BM-12 | 121 | BT-143 | 143 |
| BD-370 | 76 | BD-89 | 74 | BM-13 | 121 | BT-144 | 143 |
| BD-371 | 76 | BD-90 | 65 | BM-14 | 121 | BT-145 | 143 |
| BD-372 | 76 | BD-91 | 73 | BM-15 | 119 | BT-146 | 143 |
| BD-373 | 76 | BD-92 | 65 | BM-151 | 118 | BT-147 | 143 |
| BD-374 | 76 | BD-93 | 65 | BM-16 | 119 | BT-148 | 143 |
| BD-375 | 76 | BD-95 | 73 | BM-17 | 115 | BT-15 | 140 |
| BD-377 | 76 | BD-96 | 63 | BM-18 | 115 | BT-16 | 140 |
| BD-38 | 67 | BD-96 | 296 | BM-19 | 119 | BT-18 | 140 |
| BD-380 | 65 | BD-97 | 66 | BM-20 | 119 | BT-19 | 140 |
| BD-381 | 65 | BD-98 | 66 | BM-21 | 120 | BT-190 | 142 |
| BD-382 | 65 | BD-99 | 66 | BM-22 | 120 | BT-191 | 142 |
| BD-39 | 67 | | | BM-23 | 120 | BT-192 | 142 |
| BD-398 | 78 | BEIN-1Z | 341 | BM-24 | 120 | BT-193 | 142 |
| BD-399 | 78 | BEIN-2 | 342 | BM-28 | 116 | BT-194 | 142 |
| BD-40 | 62 | BEIN-2Z | 341 | BM-29 | 115 | BT-195 | 142 |
| BD-400 | 78 | BEIN-3 | 342 | BM-40 | 117 | BT-2 | 139 |
| BD-405 | 78 | BEIN-4 | 342 | BM-41 | 117 | BT-20 | 141 |
| BD-406 | 78 | BEIN-4Z | 341 | BM-51 | 121 | BT-25 | 141 |
| BD-409 | 78 | | | BM-60 | 117 | BT-26 | 140 |
| BD-41 | 62 | BF-01 | 95 | BM-61 | 135 | BT-27 | 140 |
| BD-410 | 78 | BF-02 | 95 | BM-62 | 135 | BT-28 | 139 |
| BD-415 | 78 | BF-05 | 95 | BM-63 | 135 | BT-284 | 141 |
| BD-416 | 78 | BF-06 | 95 | BM-64 | 135 | BT-286 | 141 |
| BD-419 | 78 | BF-07 | 95 | BM-68 | 116 | BT-291 | 141 |
| BD-42 | 62 | BF-08 | 95 | BM-69 | 116 | BT-296 | 203 |
| BD-420 | 78 | BF-10 | 94 | BM-70 | 117 | BT-297 | 203 |
| BD-43 | 62 | BF-11 | 95 | BM-71 | 117 | BT-33 | 139 |
| BD-44 | 64 | BF-12 | 94 | BM-72 | 117 | BT-34 | 139 |
| BD-45 | 64 | BF-13 | 95 | BM-73 | 115 | BT-35 | 139 |
| BD-46 | 64 | BF-20 | 94 | BM-74 | 116 | BT-36 | 139 |
| BD-47 | 64 | BF-22 | 94 | BM-79 | 119 | BT-37 | 165 |
| BD-50 | 61 | BF-23 | 94 | BM-80 | 119 | BT-370 | 140 |
| BD-51 | 64 | BF-24 | 94 | BM-83 | 120 | BT-38 | 142 |
| BD-52 | 58 | BF-25 | 94 | BM-84 | 120 | BT-39 | 142 |
| BD-53 | 73 | BF-26 | 94 | | | BT-40 | 142 |
| BD-54 | 73 | BF-27 | 94 | BR-20 | 329 | BT-41 | 142 |
| BD-56 | 295 | BF-28 | 94 | BR-25 | 329 | BT-42 | 142 |
| BD-57 | 295 | BF-29 | 94 | BR-28 | 329 | BT-43 | 139 |
| BD-58 | 295 | BF-30 | 95 | | | BT-44 | 142 |
| BD-59 | 295 | BF-31 | 95 | BS-1 | 329 | BT-45 | 142 |
| BD-60 | 61 | BF-36 | 96 | BS-100 | 329 | BT-46 | 142 |
| BD-61 | 67 | BF-37 | 96 | BS-105 | 329 | BT-50 | 140 |
| BD-62 | 61 | BF-38 | 96 | BS-20 | 299 | BT-51 | 140 |
| BD-63 | 67 | BF-40 | 96 | BS-23 | 327 | BT-52 | 140 |
| BD-64 | 61 | BF-41 | 96 | BS-27 | 327 | BT-54 | 140 |
| BD-65 | 67 | BF-42 | 96 | BS-30 | 327 | BT-55 | 140 |
| BD-66 | 61 | BF-43 | 96 | BS-40 | 327 | BT-56 | 140 |
| BD-67 | 67 | BF-44 | 96 | BS-41 | 327 | BT-60 | 139 |
| BD-70 | 65 | BF-45 | 96 | BS-42 | 327 | BT-62 | 139 |
| BD-71 | 65 | BF-46 | 96 | | | BT-64 | 139 |

| | | | | | | | |
|--------|-----|--------|-----|--------|-----|--------|-----|
| BT-66 | 139 | BV-32 | 160 | CS-06 | 329 | DB-25 | 278 |
| BT-70 | 139 | BV-320 | 155 | CS-61 | 327 | DB-299 | 325 |
| BT-72 | 139 | BV-321 | 155 | CS-67 | 327 | DB-3 | 325 |
| BT-74 | 139 | BV-322 | 155 | | | DB-30 | 277 |
| BT-77 | 139 | BV-323 | 155 | CT-555 | 330 | DB-31 | 277 |
| BT-97 | 159 | BV-324 | 155 | CT-556 | 330 | DB-32 | 277 |
| BT-98 | 159 | BV-325 | 155 | CT-557 | 330 | DB-36 | 277 |
| BT-99 | 159 | BV-326 | 155 | CT-558 | 330 | DB-37 | 277 |
| | | BV-327 | 155 | CT-559 | 330 | DB-38 | 277 |
| BV-02 | 302 | BV-328 | 155 | CT-560 | 330 | DB-39 | 277 |
| BV-04 | 302 | BV-329 | 155 | CT-561 | 330 | DB-4 | 325 |
| BV-05 | 302 | BV-33 | 160 | CT-562 | 330 | DB-42 | 277 |
| BV-06 | 302 | BV-330 | 155 | CT-563 | 330 | DB-43 | 277 |
| BV-07 | 148 | BV-36 | 146 | CT-564 | 330 | DB-44 | 277 |
| BV-08 | 146 | BV-37 | 146 | CT-565 | 330 | DB-45 | 277 |
| BV-09 | 148 | BV-372 | 158 | CT-566 | 330 | DB-46 | 277 |
| BV-10 | 146 | BV-38 | 146 | CT-567 | 330 | DB-50M | 324 |
| BV-108 | 147 | BV-39 | 146 | CT-568 | 330 | DB-6A | 325 |
| BV-109 | 147 | BV-40 | 161 | CT-569 | 330 | DB-96 | 325 |
| BV-11 | 147 | BV-41 | 161 | CT-660 | 330 | DB-97 | 280 |
| BV-110 | 151 | BV-42 | 161 | CT-670 | 330 | DB-98 | 280 |
| BV-111 | 148 | BV-43 | 161 | CT-672 | 330 | DB-99 | 280 |
| BV-112 | 148 | BV-45 | 146 | CT-702 | 330 | DB-OL | 325 |
| BV-117 | 151 | BV-46 | 159 | | | DB-OLR | 324 |
| BV-118 | 151 | BV-47 | 146 | CU-1/2 | 350 | | |
| BV-119 | 152 | BV-48 | 146 | CU-3/4 | 350 | DK-28 | 339 |
| BV-12 | 146 | BV-52 | 146 | CU-5/6 | 350 | | |
| BV-120 | 152 | BV-58 | 156 | CU-7/8 | 350 | DL-05 | 347 |
| BV-13 | 147 | BV-60 | 156 | | | DL-06 | 347 |
| BV-135 | 154 | BV-62 | 156 | DA-01 | 339 | DL-102 | 344 |
| BV-136 | 154 | BV-67 | 156 | DA-02 | 339 | DL-103 | 344 |
| BV-137 | 154 | BV-68 | 153 | | | DL-112 | 344 |
| BV-138 | 154 | BV-69 | 153 | DB-07 | 323 | DL-113 | 344 |
| BV-139 | 154 | BV-70 | 153 | DB-08 | 323 | DL-123 | 345 |
| BV-14 | 145 | BV-71 | 153 | DB-100 | 281 | DL-124 | 345 |
| BV-141 | 158 | BV-72 | 153 | DB-101 | 202 | DL-20 | 342 |
| BV-142 | 158 | BV-73 | 153 | DB-102 | 202 | DL-21 | 342 |
| BV-143 | 158 | BV-74 | 153 | DB-103 | 202 | DL-22 | 342 |
| BV-145 | 158 | BV-75 | 153 | DB-104 | 202 | DL-30 | 341 |
| BV-146 | 158 | BV-76 | 151 | DB-105 | 202 | DL-31 | 341 |
| BV-148 | 158 | BV-77 | 151 | DB-106 | 281 | DL-37 | 343 |
| BV-14M | 145 | BV-78 | 151 | DB-107 | 281 | DL-38 | 343 |
| BV-15 | 145 | BV-79 | 151 | DB-108 | 281 | DL-40 | 341 |
| BV-150 | 159 | BV-80 | 157 | DB-109 | 281 | DL-41 | 341 |
| BV-151 | 159 | BV-84 | 157 | DB-111 | 279 | DL-56 | 347 |
| BV-152 | 159 | BV-85 | 157 | DB-113 | 279 | DL-73 | 345 |
| BV-16 | 145 | BV-86 | 157 | DB-114 | 279 | DL-78 | 343 |
| BV-17 | 145 | BV-90 | 150 | DB-120 | 280 | DL-79 | 343 |
| BV-18 | 149 | BV-91 | 150 | DB-121 | 280 | DL-81 | 340 |
| BV-19 | 149 | BV-914 | 144 | DB-122 | 280 | DL-82 | 340 |
| BV-20 | 149 | BV-915 | 144 | DB-123 | 279 | DL-83 | 340 |
| BV-21 | 149 | BV-916 | 144 | DB-124 | 279 | DL-84 | 340 |
| BV-22 | 149 | BV-917 | 144 | DB-125 | 279 | DL-85 | 340 |
| BV-23 | 149 | BV-92 | 150 | DB-129 | 279 | DL-86 | 340 |
| BV-24 | 154 | BV-93 | 150 | DB-141 | 202 | DL-87 | 340 |
| BV-25 | 154 | | | DB-143 | 202 | | |
| BV-26 | 148 | C-1 | 174 | DB-145 | 202 | DO-1 | 233 |
| BV-27 | 152 | C-2 | 174 | DB-1L | 324 | DO-1 | 349 |
| BV-28 | 152 | C-3 | 174 | DB-20 | 277 | DO-109 | 233 |
| BV-30 | 160 | C-4 | 174 | DB-20 | 278 | DO-130 | 226 |
| BV-31 | 160 | | | DB-21 | 277 | DO-131 | 226 |
| BV-315 | 145 | CS-01 | 329 | DB-22A | 325 | DO-132 | 226 |
| BV-316 | 145 | CS-02 | 329 | DB-23 | 277 | DO-133 | 226 |
| BV-317 | 155 | CS-03 | 329 | DB-24 | 277 | DO-140 | 226 |
| BV-318 | 155 | CS-04 | 329 | DB-24 | 278 | DO-141 | 226 |
| BV-319 | 155 | CS-05 | 329 | DB-25 | 277 | DO-143 | 226 |

Nummernverzeichnis
Alphanumerical Index
Indice alfanumerico
Indice alfanumerico
Index alphanumérique

| | | | | | | | |
|--------|-----|--------|-----|--------|-----|----------|-----|
| DO-168 | 237 | EA-50 | 103 | FB-296 | 157 | FD-68 | 289 |
| DO-169 | 237 | EA-51 | 103 | FB-297 | 157 | FD-69 | 289 |
| DO-178 | 235 | EA-52 | 103 | FB-298 | 157 | FD-70 | 289 |
| DO-179 | 233 | EA-53 | 103 | FB-30 | 109 | FD-79 | 289 |
| DO-180 | 227 | EA-54 | 103 | FB-31 | 109 | FD-80 | 289 |
| DO-181 | 227 | EA-55 | 103 | FB-37 | 109 | FD-81 | 289 |
| DO-182 | 227 | EA-60 | 319 | FB-46 | 107 | FD-92 | 292 |
| DO-183 | 227 | EA-62 | 319 | FB-50 | 107 | FD-93 | 292 |
| DO-184 | 227 | EA-63 | 319 | FB-51 | 107 | FD-94 | 292 |
| DO-185 | 227 | EA-64 | 319 | FB-88 | 107 | FD-95 | 292 |
| DO-186 | 227 | EA-65 | 319 | FB-89 | 107 | | |
| DO-2 | 233 | EA-66 | 319 | | | FF-102 | 202 |
| DO-2 | 349 | EA-67 | 319 | FD-01 | 288 | FF-103 | 202 |
| DO-267 | 233 | EA-70 | 319 | FD-02 | 288 | FF-104 | 202 |
| DO-3 | 233 | EA-72 | 319 | FD-04 | 288 | FF-105 | 202 |
| DO-3 | 349 | EA-74 | 319 | FD-05 | 288 | FF-120 | 201 |
| DO-30 | 118 | EA-76 | 319 | FD-07 | 289 | FF-121 | 201 |
| DO-31 | 118 | EA-77 | 319 | FD-09 | 289 | FF-122 | 201 |
| DO-32 | 118 | EA-78 | 319 | FD-10 | 287 | FF-123 | 201 |
| DO-33 | 118 | EA-79 | 319 | FD-105 | 291 | FF-124 | 201 |
| DO-44 | 118 | | | FD-106 | 291 | FF-125 | 201 |
| DO-49 | 118 | ER-49 | 318 | FD-107 | 291 | FF-128 | 201 |
| DO-59 | 180 | ER-61 | 318 | FD-108 | 291 | FF-129 | 201 |
| DO-63 | 180 | ER-62 | 318 | FD-109 | 291 | FF-13 | 283 |
| DO-65 | 180 | ER-63 | 318 | FD-11 | 289 | FF-130 | 201 |
| DO-67 | 180 | ER-67 | 367 | FD-110 | 291 | FF-133 | 201 |
| DO-70 | 235 | ER-68 | 367 | FD-12 | 287 | FF-134 | 201 |
| DO-71 | 235 | ER-69 | 367 | FD-124 | 287 | FF-135 | 201 |
| DO-75 | 235 | ER-70 | 367 | FD-125 | 287 | FF-136 | 201 |
| DO-76 | 235 | | | FD-126 | 287 | FF-138 | 201 |
| | | ES-48 | 298 | FD-127 | 287 | FF-139 | 201 |
| DP-101 | 260 | ES-64 | 298 | FD-13 | 287 | FF-13M | 283 |
| DP-102 | 260 | ES-65 | 298 | FD-131 | 298 | FF-13MR | 283 |
| DP-103 | 260 | | | FD-137 | 290 | FF-13MRT | 283 |
| DP-104 | 260 | FB-01 | 101 | FD-138 | 290 | FF-147 | 223 |
| DP-105 | 260 | FB-02 | 101 | FD-15 | 287 | FF-148 | 223 |
| DP-41 | 259 | FB-03 | 108 | FD-152 | 292 | FF-149 | 223 |
| DP-49 | 262 | FB-04 | 108 | FD-153 | 292 | FF-190 | 162 |
| DP-71 | 259 | FB-05 | 108 | FD-154 | 292 | FF-191 | 162 |
| DP-75 | 259 | FB-08 | 108 | FD-155 | 292 | FF-192 | 162 |
| DP-84 | 259 | FB-08 | 108 | FD-18 | 123 | FF-200M | 162 |
| DP-90 | 260 | FB-10 | 109 | FD-20 | 123 | FF-201M | 162 |
| DP-91 | 260 | FB-11 | 108 | FD-21 | 123 | FF-202 | 162 |
| DP-92 | 260 | FB-12 | 108 | FD-214 | 291 | FF-203 | 162 |
| | | FB-13 | 108 | FD-214 | 292 | FF-203 | 162 |
| DR-40 | 339 | FB-14 | 101 | FD-215 | 291 | FF-204 | 162 |
| DR-50 | 339 | FB-15 | 101 | FD-215 | 292 | FF-205 | 162 |
| DR-60 | 339 | FB-17 | 110 | FD-216 | 292 | FF-205 | 162 |
| DR-70 | 339 | FB-18 | 110 | FD-217 | 292 | FF-206 | 162 |
| | | FB-19 | 109 | FD-22 | 122 | FF-206 | 162 |
| EA-10 | 104 | FB-20 | 109 | FD-23 | 123 | FF-207 | 162 |
| EA-11 | 104 | FB-21 | 110 | FD-25 | 123 | FF-401 | 282 |
| EA-12 | 104 | FB-22 | 109 | FD-28 | 122 | FF-402 | 282 |
| EA-13 | 104 | FB-23 | 109 | FD-29 | 123 | FF-403 | 282 |
| EA-14 | 104 | FB-236 | 106 | FD-30 | 122 | FF-404 | 282 |
| EA-15 | 104 | FB-237 | 106 | FD-32 | 122 | FF-72 | 202 |
| EA-20 | 105 | FB-238 | 106 | FD-34 | 122 | FF-73 | 202 |
| EA-21 | 105 | FB-239 | 106 | FD-37 | 122 | FF-74 | 202 |
| EA-30 | 102 | FB-251 | 106 | FD-41 | 288 | | |
| EA-31 | 102 | FB-252 | 106 | FD-42 | 288 | FG-1 | 37 |
| EA-32 | 102 | FB-253 | 106 | FD-43 | 288 | FG-10 | 52 |
| EA-33 | 102 | FB-254 | 106 | FD-44 | 288 | FG-100 | 39 |
| EA-36 | 102 | FB-255 | 106 | FD-64 | 287 | FG-101 | 37 |
| EA-37 | 102 | FB-256 | 106 | FD-65 | 287 | FG-101 | 290 |
| EA-38 | 102 | FB-257 | 106 | FD-66 | 289 | FG-102 | 37 |
| EA-39 | 102 | FB-29 | 109 | FD-67 | 289 | FG-102 | 290 |

| | | | | | | | |
|--------|-----|--------|-----|--------|-----|--------|-----|
| FG-103 | 37 | FG-54 | 38 | FK-16 | 165 | FK-54 | 170 |
| FG-105 | 37 | FG-55 | 38 | FK-164 | 173 | FK-55 | 170 |
| FG-11L | 44 | FG-56 | 38 | FK-168 | 173 | FK-56 | 172 |
| FG-121 | 54 | FG-57 | 38 | FK-169 | 173 | FK-57 | 173 |
| FG-124 | 44 | FG-58 | 44 | FK-17 | 165 | FK-58 | 171 |
| FG-12L | 44 | FG-60 | 54 | FK-174 | 237 | FK-59 | 171 |
| FG-13 | 37 | FG-61 | 54 | FK-175 | 237 | FK-60 | 178 |
| FG-13 | 290 | FG-63 | 30 | FK-176 | 172 | FK-61 | 178 |
| FG-134 | 55 | FG-64 | 30 | FK-177 | 176 | FK-62 | 178 |
| FG-137 | 55 | FG-66 | 54 | FK-178 | 176 | FK-63 | 178 |
| FG-138 | 40 | FG-67 | 54 | FK-179 | 172 | FK-64 | 178 |
| FG-139 | 40 | FG-6C | 54 | FK-18 | 165 | FK-65 | 178 |
| FG-14 | 45 | FG-6R | 54 | FK-19 | 165 | FK-66 | 178 |
| FG-140 | 46 | FG-70 | 52 | FK-193 | 232 | FK-67 | 178 |
| FG-141 | 46 | FG-71 | 52 | FK-194 | 232 | FK-68 | 178 |
| FG-142 | 46 | FG-72 | 52 | FK-195 | 232 | FK-69 | 178 |
| FG-147 | 46 | FG-78 | 52 | FK-196 | 232 | FK-70 | 175 |
| FG-148 | 46 | FG-79 | 52 | FK-197 | 177 | FK-71 | 175 |
| FG-15 | 37 | FG-86 | 52 | FK-198 | 177 | FK-72 | 176 |
| FG-15 | 290 | FG-87 | 52 | FK-199 | 232 | FK-73 | 176 |
| FG-16 | 40 | FG-89 | 52 | FK-1SC | 20 | FK-74 | 176 |
| FG-160 | 260 | FG-92 | 25 | FK-1TC | 25 | FK-75 | 175 |
| FG-161 | 260 | FG-96 | 53 | FK-2 | 46 | FK-76 | 175 |
| FG-167 | 24 | FG-97 | 53 | FK-20 | 168 | FK-77 | 175 |
| FG-168 | 24 | | | FK-230 | 166 | FK-78 | 175 |
| FG-17 | 40 | FK-01 | 178 | FK-232 | 166 | FK-79 | 176 |
| FG-18 | 40 | FK-02 | 178 | FK-234 | 166 | FK-80 | 166 |
| FG-19C | 54 | FK-03 | 178 | FK-243 | 238 | FK-81 | 171 |
| FG-19R | 54 | FK-04 | 178 | FK-244 | 238 | FK-82 | 166 |
| FG-1SC | 20 | FK-05 | 178 | FK-247 | 167 | FK-83 | 175 |
| FG-1TC | 24 | FK-06 | 178 | FK-248 | 167 | FK-84 | 175 |
| FG-2 | 37 | FK-07 | 178 | FK-249 | 167 | FK-85 | 234 |
| FG-209 | 38 | FK-08 | 178 | FK-250 | 167 | FK-86 | 234 |
| FG-209 | 290 | FK-1 | 46 | FK-251 | 167 | FK-89 | 232 |
| FG-21 | 44 | FK-100 | 216 | FK-252 | 166 | FK-90 | 215 |
| FG-210 | 38 | FK-101 | 216 | FK-254 | 167 | FK-91 | 215 |
| FG-210 | 290 | FK-102 | 216 | FK-255 | 167 | FK-92 | 215 |
| FG-211 | 38 | FK-103 | 216 | FK-256 | 167 | FK-93 | 172 |
| FG-212 | 38 | FK-104 | 216 | FK-257 | 167 | FK-94 | 234 |
| FG-22 | 44 | FK-105 | 217 | FK-258 | 167 | FK-95 | 234 |
| FG-23 | 36 | FK-106 | 217 | FK-260 | 166 | FK-96 | 236 |
| FG-24 | 36 | FK-107 | 217 | FK-261 | 166 | FK-97 | 236 |
| FG-25 | 36 | FK-108 | 217 | FK-262 | 166 | FK-98 | 236 |
| FG-26 | 36 | FK-109 | 217 | FK-263 | 166 | FK-99 | 236 |
| FG-27 | 36 | FK-11 | 238 | FK-27 | 168 | | |
| FG-28 | 45 | FK-110 | 179 | FK-28 | 168 | FL-01 | 222 |
| FG-2SC | 20 | FK-111 | 179 | FK-2SC | 20 | FL-03 | 225 |
| FG-2TC | 24 | FK-112 | 179 | FK-2TC | 25 | FL-04 | 225 |
| FG-31 | 55 | FK-113 | 179 | FK-30 | 168 | FL-05 | 225 |
| FG-32 | 55 | FK-114 | 179 | FK-31 | 177 | FL-06 | 221 |
| FG-33 | 55 | FK-115 | 179 | FK-32 | 177 | FL-100 | 228 |
| FG-34 | 53 | FK-116 | 179 | FK-33 | 177 | FL-101 | 228 |
| FG-35 | 53 | FK-119 | 234 | FK-34 | 177 | FL-102 | 228 |
| FG-36 | 44 | FK-12 | 169 | FK-35 | 177 | FL-103 | 228 |
| FG-37 | 44 | FK-12 | 169 | FK-36 | 177 | FL-104 | 221 |
| FG-4 | 37 | FK-120 | 179 | FK-37 | 177 | FL-105 | 221 |
| FG-40 | 204 | FK-121 | 179 | FK-38 | 177 | FL-108 | 221 |
| FG-43 | 39 | FK-122 | 179 | FK-39 | 177 | FL-10M | 222 |
| FG-44 | 39 | FK-123 | 179 | FK-45 | 168 | FL-11 | 222 |
| FG-5 | 37 | FK-124 | 179 | FK-46 | 168 | FL-110 | 228 |
| FG-50 | 38 | FK-125 | 179 | FK-47 | 173 | FL-112 | 221 |
| FG-50 | 290 | FK-126 | 179 | FK-48 | 168 | FL-114 | 225 |
| FG-51 | 38 | FK-13 | 238 | FK-49 | 168 | FL-115 | 225 |
| FG-51 | 290 | FK-133 | 169 | FK-51 | 169 | FL-116 | 225 |
| FG-52 | 38 | FK-14 | 238 | FK-52 | 169 | FL-117 | 228 |
| FG-53 | 38 | FK-15 | 165 | FK-53 | 169 | FL-118 | 225 |

Nummernverzeichnis
Alphanumerical Index
Indice alfanumerico
Indice alfanumerico
Index alphanumérique

| | | | | | | | |
|--------|-----|---------|-----|---------|----|---------|-----|
| FL-119 | 228 | FL-30 | 223 | FM-127 | 45 | FM-28 | 42 |
| FL-12 | 222 | FL-31 | 223 | FM-13 | 48 | FM-29 | 42 |
| FL-128 | 222 | FL-32 | 226 | FM-130 | 30 | FM-296 | 19 |
| FL-13 | 225 | FL-33 | 223 | FM-131 | 30 | FM-297 | 19 |
| FL-132 | 225 | FL-34 | 229 | FM-132 | 30 | FM-298 | 19 |
| FL-135 | 225 | FL-35 | 223 | FM-133 | 30 | FM-299 | 19 |
| FL-136 | 225 | FL-359 | 229 | FM-134 | 31 | FM-29SC | 21 |
| FL-14 | 225 | FL-36 | 229 | FM-135 | 31 | FM-2F | 35 |
| FL-15 | 225 | FL-380 | 230 | FM-136 | 31 | FM-2SC | 20 |
| FL-150 | 215 | FL-381 | 230 | FM-137 | 31 | FM-3 | 35 |
| FL-151 | 215 | FL-382 | 230 | FM-139 | 32 | FM-30 | 42 |
| FL-152 | 215 | FL-41 | 229 | FM-14 | 48 | FM-300 | 19 |
| FL-153 | 215 | FL-42 | 229 | FM-140 | 32 | FM-301 | 19 |
| FL-16 | 226 | FL-43 | 229 | FM-141 | 32 | FM-306 | 23 |
| FL-160 | 227 | FL-44 | 229 | FM-142 | 32 | FM-308 | 23 |
| FL-162 | 227 | FL-45 | 229 | FM-143 | 32 | FM-30SC | 21 |
| FL-164 | 227 | FL-46 | 229 | FM-145 | 27 | FM-31 | 42 |
| FL-166 | 227 | FL-53 | 226 | FM-146 | 27 | FM-318 | 19 |
| FL-168 | 227 | FL-54 | 226 | FM-147 | 27 | FM-319 | 19 |
| FL-17 | 226 | FL-58 | 226 | FM-148 | 27 | FM-32 | 42 |
| FL-170 | 227 | FL-59 | 229 | FM-149 | 27 | FM-328 | 23 |
| FL-172 | 227 | FL-60 | 229 | FM-15 | 48 | FM-33 | 42 |
| FL-174 | 227 | FL-61 | 229 | FM-150 | 27 | FM-337 | 23 |
| FL-176 | 227 | FL-62 | 229 | FM-151 | 27 | FM-34 | 42 |
| FL-178 | 227 | FL-63 | 228 | FM-152 | 27 | FM-343 | 23 |
| FL-18 | 226 | FL-64 | 228 | FM-153 | 27 | FM-35 | 43 |
| FL-180 | 227 | FL-81 | 228 | FM-154 | 33 | FM-350 | 25 |
| FL-181 | 225 | FL-82 | 228 | FM-155 | 33 | FM-36 | 43 |
| FL-182 | 227 | FL-83 | 228 | FM-156 | 33 | FM-37 | 43 |
| FL-183 | 225 | FL-84 | 231 | FM-159 | 33 | FM-38 | 43 |
| FL-184 | 225 | FL-85 | 231 | FM-16 | 48 | FM-39 | 43 |
| FL-185 | 225 | FL-86 | 231 | FM-160 | 28 | FM-3F | 35 |
| FL-186 | 225 | FL-87 | 231 | FM-161 | 28 | FM-3SC | 20 |
| FL-187 | 225 | FL-88 | 231 | FM-162 | 28 | FM-4 | 35 |
| FL-188 | 225 | FL-89 | 231 | FM-163 | 28 | FM-40 | 43 |
| FL-189 | 225 | FL-91 | 228 | FM-17 | 48 | FM-41 | 41 |
| FL-19 | 226 | FL-92 | 228 | FM-175 | 53 | FM-42 | 41 |
| FL-20 | 223 | FL-93 | 228 | FM-18 | 48 | FM-43 | 41 |
| FL-206 | 230 | FL-94 | 229 | FM-180 | 51 | FM-44 | 41 |
| FL-207 | 230 | FL-95 | 229 | FM-181 | 51 | FM-45 | 41 |
| FL-208 | 230 | FL-96 | 229 | FM-19 | 48 | FM-46 | 41 |
| FL-209 | 230 | FL-97 | 229 | FM-1F | 35 | FM-47 | 39 |
| FL-21 | 223 | FL-98 | 229 | FM-1SC | 20 | FM-47 | 290 |
| FL-22 | 223 | FL-99 | 229 | FM-2 | 35 | FM-48 | 39 |
| FL-253 | 223 | | | FM-20 | 47 | FM-48 | 290 |
| FL-254 | 223 | FLOHR-1 | 343 | FM-201 | 29 | FM-49 | 42 |
| FL-255 | 223 | FLOHR-2 | 343 | FM-202 | 29 | FM-4F | 35 |
| FL-256 | 223 | FLOHR-3 | 343 | FM-203 | 29 | FM-4SC | 20 |
| FL-257 | 223 | | | FM-204 | 29 | FM-5 | 47 |
| FL-258 | 223 | FM-1 | 35 | FM-205 | 29 | FM-50 | 26 |
| FL-259 | 223 | FM-10 | 43 | FM-206 | 29 | FM-51 | 26 |
| FL-260 | 229 | FM-100 | 34 | FM-207 | 29 | FM-52 | 26 |
| FL-261 | 229 | FM-100L | 34 | FM-208 | 29 | FM-53 | 26 |
| FL-262 | 229 | FM-102 | 34 | FM-209 | 29 | FM-54 | 26 |
| FL-263 | 226 | FM-104 | 34 | FM-21 | 47 | FM-55 | 26 |
| FL-264 | 226 | FM-109 | 39 | FM-210 | 29 | FM-56 | 26 |
| FL-265 | 226 | FM-11 | 48 | FM-211 | 29 | FM-57 | 26 |
| FL-266 | 226 | FM-110 | 49 | FM-212 | 29 | FM-58 | 26 |
| FL-267 | 226 | FM-111 | 49 | FM-22 | 47 | FM-59 | 26 |
| FL-268 | 226 | FM-118 | 25 | FM-23 | 47 | FM-5SC | 21 |
| FL-269 | 226 | FM-119 | 25 | FM-24 | 47 | FM-6 | 47 |
| FL-286 | 231 | FM-12 | 39 | FM-24SC | 21 | FM-60 | 26 |
| FL-287 | 231 | FM-120 | 45 | FM-25 | 47 | FM-61 | 26 |
| FL-288 | 231 | FM-121 | 45 | FM-25SC | 21 | FM-62 | 42 |
| FL-289 | 231 | FM-122 | 45 | FM-26 | 53 | FM-63 | 42 |
| FL-29 | 229 | FM-126 | 45 | FM-27 | 42 | FM-66 | 24 |

| | | | | | | | |
|--------|-----|--------|-----|--------|-----|---------|-----|
| FM-67 | 24 | FO-172 | 199 | FO-56 | 187 | G-4 | 352 |
| FM-68 | 24 | FO-173 | 199 | FO-57 | 187 | G-5 | 352 |
| FM-69 | 24 | FO-174 | 199 | FO-58 | 188 | G-8 | 13 |
| FM-6SC | 21 | FO-175 | 199 | FO-59 | 188 | | |
| FM-7 | 41 | FO-18 | 191 | FO-60 | 188 | GF-10 | 311 |
| FM-70 | 45 | FO-180 | 199 | FO-61 | 188 | GF-106 | 211 |
| FM-71 | 45 | FO-181 | 199 | FO-62 | 195 | GF-12 | 311 |
| FM-74 | 45 | FO-182 | 199 | FO-63 | 204 | GF-187 | 323 |
| FM-75 | 45 | FO-183 | 199 | FO-64 | 193 | GF-188 | 323 |
| FM-76 | 49 | FO-184 | 199 | FO-64L | 193 | GF-189 | 323 |
| FM-77 | 49 | FO-185 | 199 | FO-65 | 194 | GF-19 | 311 |
| FM-78 | 49 | FO-186 | 199 | FO-66 | 188 | GF-20 | 313 |
| FM-79 | 49 | FO-187 | 199 | FO-66L | 188 | GF-200 | 323 |
| FM-8 | 41 | FO-188 | 199 | FO-67 | 194 | GF-22 | 311 |
| FM-80 | 50 | FO-189 | 199 | FO-68 | 188 | GF-23 | 311 |
| FM-81 | 50 | FO-19 | 184 | FO-69 | 194 | GF-240 | 312 |
| FM-82 | 50 | FO-20 | 190 | FO-71 | 187 | GF-241 | 312 |
| FM-83 | 50 | FO-22 | 183 | FO-72 | 187 | GF-242 | 312 |
| FM-84 | 50 | FO-220 | 183 | FO-73 | 187 | GF-242B | 312 |
| FM-85 | 50 | FO-222 | 198 | FO-74 | 187 | GF-243 | 312 |
| FM-86 | 51 | FO-223 | 198 | FO-75 | 187 | GF-244 | 312 |
| FM-87 | 51 | FO-224 | 198 | FO-76 | 186 | GF-29 | 311 |
| FM-88 | 51 | FO-225 | 198 | FO-78 | 194 | GF-30 | 312 |
| FM-89 | 51 | FO-229 | 183 | FO-79 | 193 | GF-31 | 312 |
| FM-9 | 43 | FO-23 | 183 | FO-80 | 204 | GF-32 | 312 |
| FM-96 | 25 | FO-230 | 183 | FO-80R | 204 | GF-33 | 312 |
| | | FO-24 | 183 | FO-81 | 193 | GF-34 | 312 |
| FO-100 | 197 | FO-240 | 193 | FO-82 | 195 | GF-35 | 312 |
| FO-101 | 197 | FO-241 | 193 | FO-84 | 195 | GF-40 | 323 |
| FO-102 | 197 | FO-242 | 193 | FO-85 | 183 | GF-41 | 312 |
| FO-103 | 197 | FO-25 | 183 | FO-87 | 183 | GF-42 | 312 |
| FO-104 | 197 | FO-28 | 190 | FO-88 | 183 | GF-46 | 311 |
| FO-105 | 195 | FO-29 | 190 | FO-89 | 183 | GF-53 | 313 |
| FO-108 | 188 | FO-30 | 190 | FO-90 | 196 | GF-55 | 313 |
| FO-11 | 191 | FO-301 | 200 | FO-91 | 196 | GF-57 | 313 |
| FO-110 | 196 | FO-302 | 200 | FO-92 | 196 | GF-62 | 310 |
| FO-112 | 196 | FO-303 | 200 | FO-93 | 194 | GF-64 | 310 |
| FO-114 | 196 | FO-304 | 200 | FO-94 | 194 | GF-66 | 310 |
| FO-115 | 196 | FO-305 | 200 | FO-96 | 196 | GF-89 | 214 |
| FO-116 | 196 | FO-31 | 190 | | | GF-90 | 214 |
| FO-117 | 197 | FO-32 | 190 | FR-158 | 278 | GF-95 | 358 |
| FO-118 | 197 | FO-34 | 190 | FR-159 | 278 | | |
| FO-119 | 197 | FO-35 | 190 | FR-16 | 349 | GFC | 36 |
| FO-12 | 191 | FO-350 | 200 | FR-160 | 278 | GFC-S | 57 |
| FO-120 | 197 | FO-36 | 191 | FR-161 | 278 | GFC-SC | 22 |
| FO-121 | 197 | FO-370 | 200 | FR-162 | 278 | GFC-TC | 24 |
| FO-122 | 197 | FO-38 | 191 | FR-163 | 278 | | |
| FO-123 | 197 | FO-380 | 200 | FR-164 | 278 | GFR | 36 |
| FO-124 | 197 | FO-390 | 200 | FR-165 | 278 | GFR-S | 57 |
| FO-125 | 198 | FO-40 | 185 | FR-17 | 349 | GFR-SC | 22 |
| FO-126 | 198 | FO-41 | 185 | | | GFR-TC | 24 |
| FO-127 | 198 | FO-42 | 185 | FREER | 165 | | |
| FO-128 | 198 | FO-43 | 183 | FREER | 349 | GFS-SC | 22 |
| FO-129 | 198 | FO-44 | 186 | | | | |
| FO-13 | 191 | FO-45 | 183 | G-10 | 13 | GS-01 | 328 |
| FO-130 | 192 | FO-46 | 189 | G-12 | 13 | GS-02 | 328 |
| FO-131 | 192 | FO-47 | 189 | G-14 | 13 | GS-06 | 328 |
| FO-133 | 192 | FO-47L | 189 | G-16 | 13 | GS-07 | 328 |
| FO-134 | 192 | FO-48 | 189 | G-18 | 13 | GS-10 | 328 |
| FO-138 | 184 | FO-49 | 189 | G-20 | 13 | GS-11 | 328 |
| FO-139 | 184 | FO-50 | 186 | G-22 | 13 | GS-13 | 328 |
| FO-14 | 191 | FO-51 | 186 | G-24 | 13 | GS-14 | 328 |
| FO-15 | 184 | FO-52 | 186 | G-26 | 13 | GS-20 | 58 |
| FO-16 | 190 | FO-53 | 186 | G-28 | 13 | GS-21 | 58 |
| FO-17 | 184 | FO-54 | 186 | G-3 | 352 | GS-22 | 58 |
| FO-171 | 199 | FO-55 | 187 | G-30 | 13 | GS-23 | 57 |

Nummernverzeichnis
Alphanumerical Index
Indice alfanumerico
Indice alfanumerico
Index alphanumérique

| | | | | | | | |
|--------|-----|--------|-----|-------|-----|--------|-----|
| GS-24 | 57 | KI-209 | 269 | KI-37 | 265 | L-5 | 348 |
| GS-25 | 57 | KI-210 | 269 | KI-38 | 265 | L-6 | 348 |
| GS-26 | 57 | KI-211 | 269 | KI-39 | 265 | L-7 | 348 |
| GS-27 | 57 | KI-212 | 269 | KI-40 | 264 | L-8 | 348 |
| GS-28 | 57 | KI-22 | 264 | KI-41 | 264 | L-9 | 348 |
| GS-29 | 57 | KI-220 | 266 | KI-42 | 264 | | |
| | | KI-221 | 266 | KI-43 | 264 | LB-10 | 11 |
| HE-1 | 344 | KI-222 | 266 | KI-44 | 264 | LB-11 | 11 |
| HE-2 | 344 | KI-223 | 266 | KI-45 | 264 | LB-12 | 11 |
| HE-3 | 344 | KI-224 | 266 | KI-46 | 264 | LB-12D | 11 |
| | | KI-225 | 266 | KI-47 | 264 | LB-13 | 11 |
| KI-00 | 264 | KI-226 | 266 | KI-48 | 264 | LB-15 | 11 |
| KI-01 | 264 | KI-227 | 266 | KI-49 | 264 | LB-18 | 11 |
| KI-02 | 264 | KI-228 | 266 | KI-50 | 267 | LB-20 | 11 |
| KI-10 | 273 | KI-229 | 266 | KI-51 | 267 | LB-21 | 11 |
| KI-100 | 264 | KI-230 | 268 | KI-52 | 267 | LB-22 | 11 |
| KI-102 | 264 | KI-231 | 268 | KI-53 | 267 | LB-23 | 11 |
| KI-114 | 264 | KI-232 | 268 | KI-54 | 267 | LB-24 | 11 |
| KI-115 | 264 | KI-233 | 266 | KI-55 | 267 | LB-25 | 11 |
| KI-116 | 264 | KI-238 | 268 | KI-56 | 267 | LB-36 | 11 |
| KI-117 | 264 | KI-240 | 268 | KI-57 | 267 | LB-361 | 12 |
| KI-118 | 264 | KI-242 | 268 | KI-58 | 267 | LB-361 | 298 |
| KI-120 | 264 | KI-244 | 268 | KI-60 | 265 | LB-362 | 12 |
| KI-122 | 264 | KI-246 | 268 | KI-61 | 265 | LB-363 | 12 |
| KI-125 | 264 | KI-248 | 268 | KI-62 | 265 | LB-364 | 12 |
| KI-130 | 264 | KI-25 | 264 | KI-63 | 265 | LB-364 | 298 |
| KI-14 | 264 | KI-252 | 267 | KI-64 | 265 | LB-365 | 12 |
| KI-15 | 264 | KI-254 | 267 | KI-65 | 265 | LB-365 | 298 |
| KI-16 | 264 | KI-256 | 267 | KI-66 | 265 | LB-366 | 12 |
| KI-160 | 267 | KI-258 | 267 | KI-67 | 265 | LB-367 | 12 |
| KI-161 | 267 | KI-260 | 267 | KI-68 | 265 | LB-367 | 298 |
| KI-17 | 264 | KI-262 | 267 | KI-69 | 265 | LB-368 | 12 |
| KI-175 | 269 | KI-264 | 267 | KI-70 | 265 | LB-369 | 12 |
| KI-176 | 269 | KI-280 | 267 | KI-71 | 265 | | |
| KI-177 | 269 | KI-282 | 267 | KI-72 | 265 | LG-1 | 36 |
| KI-178 | 269 | KI-284 | 267 | KI-74 | 265 | LG-1SC | 22 |
| KI-179 | 269 | KI-286 | 267 | KI-75 | 265 | LG-2SC | 22 |
| KI-18 | 264 | KI-288 | 267 | KI-76 | 265 | | |
| KI-180 | 269 | KI-29 | 265 | KI-77 | 265 | LK-1 | 57 |
| KI-181 | 269 | KI-290 | 267 | KI-78 | 265 | LK-2 | 57 |
| KI-182 | 269 | KI-293 | 268 | KI-80 | 265 | LK-3 | 57 |
| KI-183 | 269 | KI-294 | 268 | KI-82 | 265 | | |
| KI-184 | 269 | KI-295 | 268 | KI-85 | 265 | LL-01 | 372 |
| KI-185 | 269 | KI-296 | 268 | KI-90 | 265 | LL-02 | 372 |
| KI-186 | 269 | KI-297 | 268 | KI-99 | 264 | LL-03 | 372 |
| KI-187 | 269 | KI-298 | 268 | | | LL-04 | 372 |
| KI-188 | 269 | KI-30 | 264 | KO-1 | 165 | LL-05 | 372 |
| KI-189 | 269 | KI-300 | 269 | KO-16 | 162 | LL-06 | 372 |
| KI-190 | 269 | KI-301 | 269 | KO-2 | 165 | LL-07 | 372 |
| KI-191 | 269 | KI-306 | 247 | KO-47 | 162 | LL-08 | 372 |
| KI-192 | 269 | KI-307 | 247 | | | LL-09 | 372 |
| KI-193 | 269 | KI-308 | 247 | L-0 | 348 | LL-10 | 372 |
| KI-194 | 269 | KI-31 | 265 | L-1 | 348 | LL-11 | 372 |
| KI-195 | 269 | KI-32 | 265 | L-11 | 348 | LL-12 | 372 |
| KI-196 | 269 | KI-322 | 269 | L-2 | 348 | LL-13 | 372 |
| KI-197 | 269 | KI-33 | 265 | L-21 | 348 | LL-14 | 372 |
| KI-198 | 269 | KI-330 | 268 | L-22 | 348 | LL-15 | 372 |
| KI-199 | 269 | KI-331 | 268 | L-23 | 348 | LL-16 | 372 |
| KI-20 | 264 | KI-332 | 268 | L-24 | 348 | LL-17 | 372 |
| KI-202 | 269 | KI-333 | 268 | L-25 | 348 | LL-18 | 372 |
| KI-203 | 269 | KI-334 | 268 | L-26 | 348 | LL-19 | 372 |
| KI-204 | 269 | KI-335 | 268 | L-27 | 348 | LL-20 | 372 |
| KI-205 | 269 | KI-336 | 268 | L-28 | 348 | LL-21 | 372 |
| KI-206 | 269 | KI-34 | 265 | L-29 | 348 | LL-22 | 372 |
| KI-207 | 269 | KI-35 | 265 | L-3 | 348 | LL-23 | 372 |
| KI-208 | 269 | KI-36 | 265 | L-4 | 348 | LL-24 | 372 |

| | | | | | | | |
|--------|-----|--------|-----|--------|-----|---------|-----|
| LL-25 | 372 | LS-227 | 239 | LS-49 | 271 | LX-92TC | 254 |
| LL-26 | 372 | LS-228 | 239 | LS-50 | 271 | LX-95TC | 254 |
| LL-27 | 372 | LS-229 | 239 | LS-51 | 272 | LX-96TC | 254 |
| LL-28 | 372 | LS-23 | 270 | LS-52 | 272 | LX-98 | 347 |
| LL-29 | 372 | LS-231 | 241 | LS-53 | 272 | LX-99 | 254 |
| LL-30 | 372 | LS-232 | 241 | LS-54 | 272 | | |
| LL-31 | 372 | LS-233 | 239 | LS-55 | 272 | MA-1 | 352 |
| LL-32 | 372 | LS-234 | 241 | LS-56 | 272 | MA-2 | 352 |
| LL-33 | 372 | LS-235 | 250 | LS-57 | 272 | MA-3 | 352 |
| LL-34 | 372 | LS-236 | 239 | LS-58 | 272 | MA-6 | 13 |
| LL-35 | 372 | LS-236 | 240 | LS-59 | 272 | MA-B1 | 11 |
| LL-36 | 372 | LS-237 | 240 | LS-60 | 272 | MA-B2 | 11 |
| LL-37 | 372 | LS-238 | 240 | LS-73 | 244 | MA-B3 | 11 |
| | | LS-239 | 240 | LS-74 | 244 | MA-B3L | 11 |
| LS-04 | 300 | LS-24 | 270 | LS-75 | 244 | MA-B3M | 11 |
| LS-06 | 247 | LS-240 | 246 | LS-76 | 263 | MA-B4 | 11 |
| LS-07 | 300 | LS-241 | 239 | LS-76L | 263 | MA-B4L | 11 |
| LS-08 | 300 | LS-241 | 240 | LS-78 | 263 | MA-B7 | 11 |
| LS-09 | 247 | LS-242 | 246 | LS-78L | 263 | | |
| LS-10 | 273 | LS-244 | 246 | LS-80 | 244 | MC-11 | 345 |
| LS-100 | 247 | LS-25 | 270 | LS-81 | 244 | MC-12 | 345 |
| LS-101 | 262 | LS-26 | 270 | LS-82 | 244 | MC-13 | 345 |
| LS-102 | 262 | LS-27 | 270 | LS-83 | 244 | | |
| LS-103 | 262 | LS-28 | 270 | LS-84 | 244 | MF-172 | 297 |
| LS-104 | 262 | LS-29 | 270 | LS-85 | 244 | MF-173 | 297 |
| LS-105 | 262 | LS-30 | 270 | LS-90 | 243 | MF-177 | 296 |
| LS-106 | 247 | LS-300 | 238 | LS-91 | 243 | MF-200 | 297 |
| LS-11 | 273 | LS-301 | 238 | LS-91S | 243 | MF-201 | 297 |
| LS-110 | 269 | LS-302 | 238 | LS-92 | 243 | MF-205 | 297 |
| LS-112 | 242 | LS-303 | 238 | LS-93 | 243 | MF-206 | 297 |
| LS-113 | 242 | LS-310 | 249 | LS-94 | 242 | MF-249 | 296 |
| LS-114 | 242 | LS-311 | 249 | LS-95 | 242 | | |
| LS-115 | 242 | LS-312 | 249 | LS-96 | 242 | MIR-08 | 349 |
| LS-116 | 245 | LS-313 | 249 | LS-97 | 242 | | |
| LS-117 | 245 | LS-314 | 249 | LS-98 | 242 | MO-10 | 349 |
| LS-119 | 245 | LS-315 | 249 | LS-99 | 247 | MO-8 | 349 |
| LS-12 | 273 | LS-316 | 251 | LX-101 | 254 | | |
| LS-120 | 246 | LS-317 | 251 | LX-102 | 255 | NK-03 | 294 |
| LS-121 | 245 | LS-318 | 251 | LX-103 | 256 | NK-04 | 294 |
| LS-122 | 262 | LS-32 | 273 | LX-104 | 255 | NK-06 | 293 |
| LS-123 | 262 | LS-320 | 250 | LX-105 | 256 | NK-08 | 293 |
| LS-124 | 245 | LS-321 | 250 | LX-106 | 256 | NK-1 | 12 |
| LS-125 | 274 | LS-322 | 250 | LX-107 | 257 | NK-10 | 293 |
| LS-126 | 274 | LS-323 | 250 | LX-108 | 184 | NK-100 | 10 |
| LS-127 | 251 | LS-324 | 250 | LX-109 | 184 | NK-101 | 10 |
| LS-128 | 251 | LS-325 | 250 | LX-110 | 184 | NK-102 | 10 |
| LS-13 | 273 | LS-326 | 250 | LX-111 | 184 | NK-106 | 302 |
| LS-135 | 274 | LS-329 | 250 | LX-112 | 204 | NK-12 | 12 |
| LS-136 | 274 | LS-33 | 273 | LX-113 | 205 | NK-131 | 302 |
| LS-137 | 274 | LS-330 | 250 | LX-114 | 205 | NK-14 | 293 |
| LS-138 | 274 | LS-40 | 271 | LX-115 | 205 | NK-16 | 293 |
| LS-139 | 274 | LS-400 | 261 | LX-116 | 184 | NK-18 | 293 |
| LS-14 | 273 | LS-405 | 261 | LX-120 | 205 | NK-2 | 12 |
| LS-140 | 274 | LS-406 | 261 | LX-121 | 205 | NK-20 | 293 |
| LS-15 | 273 | LS-407 | 261 | LX-122 | 205 | NK-21 | 294 |
| LS-16 | 273 | LS-408 | 261 | LX-125 | 252 | NK-22 | 294 |
| LS-17 | 273 | LS-409 | 261 | LX-130 | 253 | NK-23 | 294 |
| LS-199 | 248 | LS-41 | 271 | LX-131 | 253 | NK-24 | 294 |
| LS-20 | 270 | LS-410 | 262 | LX-134 | 253 | NK-245 | 278 |
| LS-200 | 248 | LS-42 | 271 | LX-135 | 258 | NK-25 | 294 |
| LS-201 | 248 | LS-43 | 271 | LX-136 | 258 | NK-26 | 294 |
| LS-202 | 248 | LS-44 | 271 | LX-138 | 260 | NK-27 | 294 |
| LS-21 | 270 | LS-45 | 271 | LX-139 | 260 | NK-28 | 294 |
| LS-22 | 270 | LS-46 | 271 | LX-70 | 346 | NK-29 | 294 |
| LS-222 | 241 | LS-47 | 271 | LX-80 | 258 | NK-3 | 12 |
| LS-224 | 241 | LS-48 | 271 | LX-82 | 254 | NK-30 | 10 |

Nummernverzeichnis
Alphanumerical Index
Indice alfanumerico
Indice alfanumerico
Index alphanumérique

| | | | | | | | |
|--------|-----|--------|-----|-------|-----|-------|-----|
| NK-32 | 10 | OL-156 | 213 | OM-20 | 317 | P-134 | 89 |
| NK-34 | 10 | OL-157 | 213 | OM-22 | 317 | P-135 | 81 |
| NK-36 | 10 | OL-158 | 213 | OM-23 | 317 | P-136 | 92 |
| NK-38 | 10 | OL-159 | 213 | OM-24 | 317 | P-137 | 92 |
| NK-40 | 10 | OL-16 | 310 | OM-26 | 317 | P-138 | 92 |
| NK-401 | 297 | OL-17 | 310 | OM-30 | 9 | P-139 | 92 |
| NK-403 | 297 | OL-18 | 310 | OM-32 | 317 | P-14 | 105 |
| NK-41 | 294 | OL-19 | 309 | OM-34 | 317 | P-140 | 105 |
| NK-42 | 294 | OL-20 | 295 | OM-36 | 317 | P-141 | 105 |
| NK-420 | 301 | OL-22 | 299 | OM-38 | 317 | P-15 | 81 |
| NK-421 | 301 | OL-22 | 310 | OM-45 | 9 | P-16 | 82 |
| NK-422 | 301 | OL-23 | 310 | OM-46 | 9 | P-17 | 88 |
| NK-43 | 294 | OL-24 | 310 | OM-80 | 15 | P-170 | 92 |
| NK-44 | 294 | OL-25 | 309 | OM-81 | 15 | P-171 | 92 |
| NK-45 | 294 | OL-26 | 309 | OM-82 | 15 | P-172 | 92 |
| NK-46 | 294 | OL-27 | 309 | | | P-173 | 92 |
| NK-47 | 294 | OL-28 | 309 | OR-11 | 300 | P-179 | 93 |
| NK-48 | 293 | OL-29 | 309 | OR-13 | 300 | P-18 | 83 |
| NK-49 | 293 | OL-30 | 310 | OR-15 | 300 | P-180 | 93 |
| NK-50 | 10 | OL-31 | 310 | OR-17 | 300 | P-181 | 93 |
| NK-51 | 10 | OL-32 | 310 | OR-19 | 300 | P-19 | 83 |
| NK-52 | 10 | OL-33 | 310 | | | P-191 | 91 |
| NK-53 | 10 | OL-34 | 309 | OSB-1 | 349 | P-192 | 91 |
| NK-54 | 10 | OL-36 | 299 | OSB-2 | 349 | P-193 | 91 |
| NK-55 | 10 | OL-36 | 309 | | | P-194 | 91 |
| NK-56 | 10 | OL-37 | 309 | P-0 | 13 | P-195 | 91 |
| NK-59 | 293 | OL-38 | 309 | P-00 | 13 | P-196 | 91 |
| NK-60 | 296 | OL-39 | 309 | P-01 | 13 | P-197 | 91 |
| NK-62 | 296 | OL-40 | 214 | P-02 | 13 | P-198 | 111 |
| NK-64 | 296 | OL-41 | 213 | P-03 | 13 | P-199 | 111 |
| NK-66 | 296 | OL-42 | 213 | P-04 | 13 | P-20 | 85 |
| NK-69 | 296 | OL-43 | 213 | P-05 | 13 | P-200 | 91 |
| NK-70 | 296 | OL-44 | 213 | P-06 | 13 | P-201 | 90 |
| NK-79 | 301 | OL-45 | 213 | P-06A | 13 | P-202 | 90 |
| NK-80 | 301 | OL-46 | 213 | P-06B | 13 | P-203 | 90 |
| NK-82 | 301 | OL-47 | 213 | P-06C | 13 | P-204 | 90 |
| NK-83 | 301 | OL-48 | 213 | P-06D | 13 | P-205 | 90 |
| NK-84 | 301 | OL-49 | 213 | P-08 | 88 | P-206 | 90 |
| NK-86 | 301 | OL-50 | 299 | P-09 | 88 | P-208 | 90 |
| NK-92 | 302 | OL-51 | 299 | P-10 | 105 | P-209 | 90 |
| NK-95 | 10 | OL-52 | 299 | P-100 | 89 | P-21 | 85 |
| NK-96 | 10 | OL-53 | 299 | P-100 | 298 | P-210 | 92 |
| NK-97 | 293 | OL-54 | 299 | P-101 | 81 | P-211 | 90 |
| NK-98 | 293 | OL-55 | 299 | P-102 | 81 | P-212 | 90 |
| NK-99 | 293 | OL-56 | 299 | P-103 | 111 | P-213 | 90 |
| | | OL-57 | 299 | P-104 | 88 | P-214 | 90 |
| OL-01 | 213 | OL-58 | 299 | P-11 | 105 | P-215 | 91 |
| OL-04 | 213 | OL-63 | 309 | P-113 | 111 | P-216 | 91 |
| OL-05 | 213 | OL-64 | 309 | P-114 | 111 | P-217 | 91 |
| OL-06 | 309 | OM-04 | 14 | P-115 | 89 | P-218 | 101 |
| OL-07 | 299 | OM-05 | 14 | P-118 | 89 | P-219 | 101 |
| OL-07 | 309 | OM-07 | 14 | P-119 | 89 | P-22 | 85 |
| OL-08 | 299 | OM-09 | 295 | P-12 | 105 | P-221 | 83 |
| OL-08 | 309 | OM-10 | 9 | P-120 | 87 | P-224 | 111 |
| OL-09 | 309 | OM-101 | 15 | P-120 | 298 | P-225 | 111 |
| OL-10 | 309 | OM-102 | 15 | P-121 | 87 | P-226 | 111 |
| OL-11 | 309 | OM-103 | 15 | P-121 | 298 | P-23 | 85 |
| OL-13 | 310 | OM-104 | 15 | P-122 | 82 | P-24 | 85 |
| OL-14 | 310 | OM-12 | 9 | P-123 | 93 | P-248 | 83 |
| OL-15 | 310 | OM-13 | 9 | P-125 | 93 | P-249 | 83 |
| OL-150 | 213 | OM-14 | 9 | P-129 | 89 | P-25 | 85 |
| OL-151 | 213 | OM-15 | 9 | P-13 | 105 | P-250 | 84 |
| OL-152 | 213 | OM-16 | 14 | P-130 | 101 | P-251 | 84 |
| OL-153 | 213 | OM-17 | 14 | P-131 | 101 | P-252 | 84 |
| OL-154 | 213 | OM-18 | 14 | P-132 | 89 | P-253 | 84 |
| OL-155 | 213 | OM-19 | 14 | P-133 | 89 | P-254 | 84 |

| | | | | | | | |
|-------|-----|---------|-----|--------|-----|--------|-----|
| P-255 | 84 | P-71 | 86 | PF-46 | 308 | PH-63 | 133 |
| P-256 | 84 | P-72 | 86 | PF-48 | 308 | PH-64 | 133 |
| P-257 | 84 | P-73 | 86 | PF-49 | 308 | PH-65 | 126 |
| P-258 | 84 | P-74 | 86 | PF-50 | 308 | PH-66 | 126 |
| P-259 | 84 | P-75 | 86 | PF-51 | 308 | PH-68 | 126 |
| P-26 | 85 | P-76 | 86 | PF-52 | 308 | PH-69 | 126 |
| P-260 | 84 | P-77 | 86 | PF-53 | 307 | PH-70 | 134 |
| P-261 | 84 | P-78 | 86 | PF-54 | 307 | PH-71 | 126 |
| P-262 | 84 | P-79 | 87 | PF-55 | 307 | PH-72 | 127 |
| P-263 | 84 | P-81 | 82 | PF-56 | 307 | PH-73 | 126 |
| P-264 | 87 | P-82 | 82 | PF-57 | 307 | PH-74 | 134 |
| P-265 | 87 | P-84 | 87 | PF-58 | 307 | PH-75 | 127 |
| P-266 | 82 | P-85 | 87 | PF-59 | 307 | PH-76 | 127 |
| P-267 | 82 | P-86 | 82 | PF-7 | 307 | PH-77 | 128 |
| P-27 | 85 | P-87 | 82 | PF-80 | 307 | PH-78 | 134 |
| P-28 | 83 | P-89 | 87 | PF-82 | 307 | PH-80 | 131 |
| P-285 | 101 | P-91 | 81 | PF-83 | 307 | PH-81 | 131 |
| P-286 | 101 | P-92 | 81 | | | PH-82 | 131 |
| P-287 | 101 | P-93 | 81 | PH-101 | 129 | PH-83 | 131 |
| P-288 | 101 | P-94 | 81 | PH-102 | 129 | PH-84 | 131 |
| P-29 | 83 | P-95 | 81 | PH-103 | 129 | PH-90 | 128 |
| P-3 | 352 | P-96 | 81 | PH-104 | 129 | | |
| P-30 | 85 | P-97 | 81 | PH-110 | 129 | PO-100 | 124 |
| P-308 | 88 | P-98 | 81 | PH-111 | 129 | PO-34 | 125 |
| P-31 | 85 | P-99 | 111 | PH-112 | 129 | PO-35 | 125 |
| P-312 | 88 | | | PH-113 | 129 | PO-36 | 125 |
| P-313 | 88 | PEB-1 | 338 | PH-114 | 129 | PO-40 | 132 |
| P-32 | 85 | PEB-17S | 335 | PH-115 | 127 | PO-46 | 124 |
| P-324 | 89 | PEB-2 | 338 | PH-117 | 127 | PO-47 | 124 |
| P-33 | 85 | PEB-3 | 338 | PH-118 | 127 | PO-48 | 124 |
| P-34 | 85 | PEB-4 | 338 | PH-119 | 127 | PO-50 | 124 |
| P-35 | 85 | PEB-5 | 338 | PH-120 | 127 | PO-51 | 124 |
| P-36 | 85 | PEB-6 | 338 | PH-121 | 127 | PO-52 | 124 |
| P-37 | 85 | PEB-7 | 338 | PH-122 | 127 | PO-55 | 125 |
| P-38 | 83 | | | PH-123 | 127 | PO-56 | 125 |
| P-39 | 83 | PF-10 | 308 | PH-124 | 127 | PO-59 | 135 |
| P-4 | 352 | PF-13 | 308 | PH-125 | 127 | PO-60 | 132 |
| P-40 | 86 | PF-14 | 307 | PH-127 | 128 | PO-65 | 132 |
| P-41 | 86 | PF-15 | 307 | PH-128 | 128 | PO-66 | 124 |
| P-42 | 86 | PF-17 | 307 | PH-129 | 128 | PO-67 | 132 |
| P-43 | 86 | PF-19 | 307 | PH-130 | 128 | PO-71 | 132 |
| P-44 | 86 | PF-20 | 307 | PH-131 | 128 | PO-78 | 132 |
| P-45 | 86 | PF-21 | 307 | PH-132 | 131 | PO-79 | 132 |
| P-46 | 86 | PF-22 | 307 | PH-133 | 131 | PO-80 | 132 |
| P-47 | 86 | PF-23 | 307 | PH-134 | 131 | PO-81 | 132 |
| P-48 | 86 | PF-24 | 307 | PH-38 | 133 | PO-82 | 125 |
| P-49 | 87 | PF-25 | 307 | PH-39 | 133 | PO-83 | 125 |
| P-5 | 352 | PF-26 | 307 | PH-40 | 134 | PO-84 | 125 |
| P-50 | 89 | PF-27 | 307 | PH-41 | 134 | PO-85 | 125 |
| P-52 | 89 | PF-28 | 307 | PH-42 | 134 | PO-86 | 124 |
| P-53 | 89 | PF-29 | 307 | PH-43 | 134 | PO-87 | 125 |
| P-54 | 87 | PF-30 | 307 | PH-44 | 134 | PO-88 | 132 |
| P-55 | 87 | PF-31 | 307 | PH-45 | 134 | PO-89 | 135 |
| P-56 | 83 | PF-32 | 307 | PH-46 | 134 | PO-90 | 132 |
| P-57 | 83 | PF-33 | 307 | PH-48 | 133 | PO-91 | 132 |
| P-58 | 83 | PF-34 | 307 | PH-52 | 134 | PO-92 | 125 |
| P-59 | 83 | PF-35 | 307 | PH-53 | 126 | PO-94 | 132 |
| P-60 | 88 | PF-36 | 307 | PH-54 | 126 | PO-95 | 124 |
| P-61 | 82 | PF-37 | 307 | PH-55 | 252 | PO-96 | 124 |
| P-62 | 82 | PF-38 | 307 | PH-56 | 252 | PO-97 | 130 |
| P-63 | 82 | PF-39 | 308 | PH-57 | 252 | PO-97L | 130 |
| P-64 | 82 | PF-40 | 308 | PH-58 | 128 | PO-98 | 124 |
| P-65 | 91 | PF-41 | 308 | PH-59 | 252 | PO-99 | 130 |
| P-66 | 91 | PF-42 | 308 | PH-59 | 127 | PO-99L | 130 |
| P-67 | 91 | PF-43 | 308 | PH-61 | 133 | | |
| P-70 | 86 | PF-44 | 307 | PH-62 | 133 | R-1 | 351 |

Nummernverzeichnis
Alphanumerical Index
Indice alfanumerico
Indice alfanumerico
Index alphanumérique

| | | | | | | | |
|-------|-----|---------|-----|--------|-----|-------|-----|
| R-2 | 351 | TR-41 | 209 | VF-26 | 356 | VH-28 | 355 |
| R-3 | 351 | TR-42 | 209 | VF-28 | 357 | VH-30 | 369 |
| | | TR-43 | 209 | VF-29 | 357 | VH-31 | 369 |
| RH-4 | 352 | TR-44 | 209 | VF-300 | 373 | VH-32 | 369 |
| RH-5 | 352 | TR-45 | 209 | VF-301 | 373 | VH-40 | 253 |
| | | TR-46 | 209 | VF-302 | 373 | VH-48 | 346 |
| SC-1 | 56 | TR-49 | 213 | VF-32 | 357 | VH-49 | 346 |
| SC-13 | 56 | TR-50 | 213 | VF-37 | 357 | VH-50 | 346 |
| SC-14 | 56 | TR-51 | 209 | VF-38 | 356 | VH-51 | 346 |
| SC-15 | 56 | TR-52 | 209 | VF-39 | 356 | VH-52 | 346 |
| SC-2 | 56 | TR-53 | 209 | VF-40 | 318 | VH-52 | 369 |
| SC-3 | 56 | TR-54 | 209 | VF-42 | 318 | VH-53 | 346 |
| SC-5 | 56 | TR-55 | 209 | VF-42 | 318 | VH-54 | 346 |
| SC-9 | 56 | TR-56 | 209 | VF-47 | 368 | VH-55 | 346 |
| | | TR-57 | 209 | VF-48 | 368 | VH-56 | 358 |
| SD-M | 348 | TR-60 | 211 | VF-50 | 357 | VH-58 | 358 |
| | | TR-61 | 210 | VF-55 | 361 | VH-60 | 358 |
| SL-1 | 174 | TR-62 | 210 | VF-56 | 361 | VH-74 | 358 |
| SL-2 | 174 | TR-68 | 211 | VF-57 | 361 | | |
| | | TR-69 | 211 | VF-58 | 361 | VS-20 | 329 |
| SM-1 | 351 | TR-76 | 215 | VF-59 | 361 | VS-26 | 329 |
| SM-11 | 351 | TR-77 | 215 | VF-60 | 361 | VS-30 | 329 |
| SM-12 | 351 | | | VF-68 | 368 | | |
| SM-13 | 351 | TS-101 | 326 | VF-69 | 368 | WG-10 | 165 |
| SM-15 | 351 | TS-102 | 326 | VF-70 | 366 | WG-12 | 165 |
| SM-3 | 351 | TS-103 | 326 | VF-71 | 366 | WG-14 | 165 |
| SM-4 | 351 | TS-104 | 326 | VF-72 | 366 | | |
| | | | | VF-73 | 359 | | |
| SO-10 | 351 | VF-100 | 364 | VF-74 | 359 | | |
| SO-3 | 351 | VF-102 | 320 | VF-75 | 359 | | |
| SO-4 | 351 | VF-102M | 320 | VF-76 | 359 | | |
| | | VF-110 | 319 | VF-77 | 359 | | |
| SV-11 | 371 | VF-112 | 319 | VF-78 | 359 | | |
| SV-12 | 371 | VF-113 | 319 | VF-80 | 360 | | |
| SV-13 | 371 | VF-114 | 319 | VF-81 | 360 | | |
| SV-15 | 371 | VF-115 | 366 | VF-82 | 360 | | |
| SV-16 | 371 | VF-116 | 320 | VF-83 | 360 | | |
| SV-17 | 372 | VF-117 | 319 | VF-84 | 360 | | |
| SV-18 | 370 | VF-118 | 366 | VF-85 | 360 | | |
| SV-19 | 370 | VF-119 | 366 | VF-86 | 360 | | |
| SV-20 | 370 | VF-120 | 346 | VF-88 | 360 | | |
| SV-21 | 370 | VF-121 | 346 | VF-89 | 320 | | |
| | | VF-121M | 346 | VF-90 | 320 | | |
| TG-10 | 224 | VF-122 | 346 | VF-92 | 365 | | |
| TG-11 | 224 | VF-124 | 320 | VF-94 | 365 | | |
| TG-12 | 224 | VF-126 | 347 | VF-95 | 364 | | |
| TG-20 | 224 | VF-127 | 347 | VF-96 | 364 | | |
| TG-21 | 224 | VF-130 | 320 | VF-97 | 364 | | |
| TG-22 | 224 | VF-131 | 320 | VF-98 | 257 | | |
| TG-23 | 224 | VF-132 | 319 | VF-98M | 257 | | |
| TG-40 | 224 | VF-141 | 365 | VF-99 | 364 | | |
| TG-41 | 224 | VF-15 | 362 | | | | |
| | | VF-16 | 362 | VH-10 | 320 | | |
| TR-14 | 212 | VF-168 | 359 | VH-10 | 355 | | |
| TR-16 | 212 | VF-169 | 359 | VH-100 | 367 | | |
| TR-18 | 212 | VF-17 | 362 | VH-12 | 355 | | |
| TR-20 | 209 | VF-180 | 374 | VH-14 | 355 | | |
| TR-21 | 209 | VF-181 | 374 | VH-15 | 355 | | |
| TR-22 | 209 | VF-201 | 363 | VH-16 | 346 | | |
| TR-23 | 209 | VF-202 | 363 | VH-18 | 355 | | |
| TR-24 | 209 | VF-203 | 363 | VH-20 | 253 | | |
| TR-25 | 209 | VF-204 | 363 | VH-21 | 253 | | |
| TR-26 | 209 | VF-207 | 363 | VH-23 | 253 | | |
| TR-30 | 214 | VF-208 | 363 | VH-24 | 355 | | |
| TR-35 | 210 | VF-209 | 363 | VH-25 | 258 | | |
| TR-40 | 209 | VF-25 | 356 | VH-26 | 355 | | |



Bontempi

SURGICAL INSTRUMENTS
PORTUGAL

Passion for Excellence

Rua Poeta de Bocage, nº 15-F, Letra J
1600-240 Lisboa
T: + 351 210 968 925
F: + 351 210 968 925

info@bontempiportugal.pt
www.bontempiportugal.pt