



Bontempi

SURGICAL INSTRUMENTS
PORTUGAL

Passion for Excellence



Additions and New Products

Plastische und Ästhetische Chirurgie
Plastic and Aesthetic Surgery
Chirurgia Plastica ed Estetica
Cirugía Plástica y Estética
Chirurgie plastique et esthétique

Chirurgische Scheren

Operating Scissors

Forbici chirurgiche

Tijeras para cirugia

Ciseaux quirurgicaux

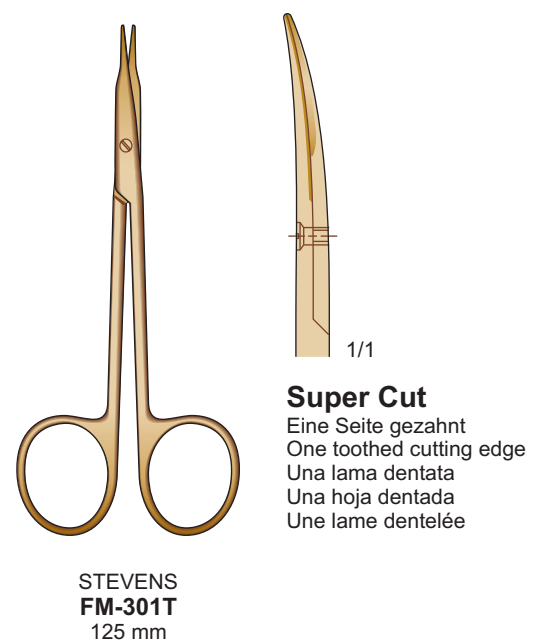
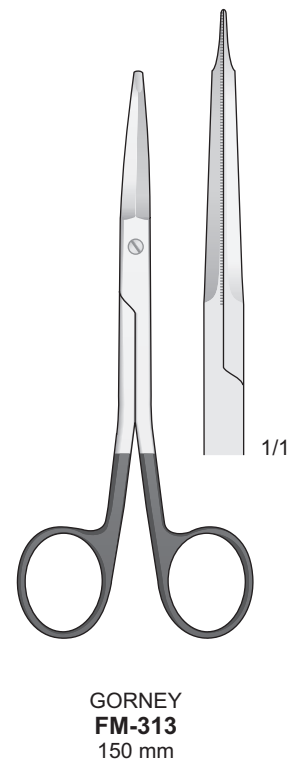
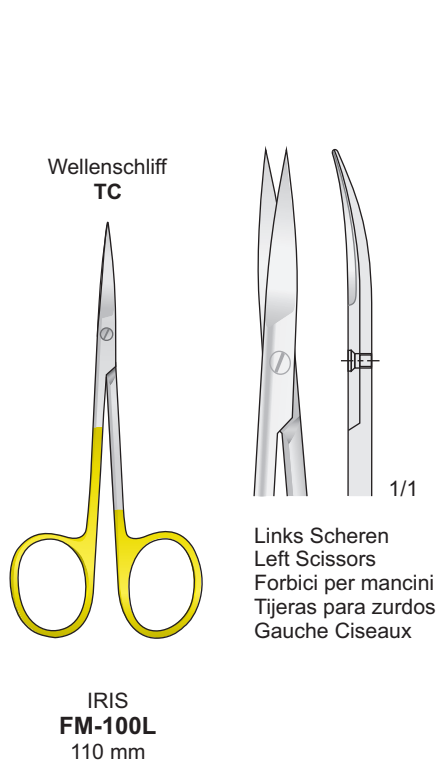

Chirurgische Scheren

Operating Scissors

Forbici chirurgiche

Tijeras para cirugía

Ciseaux quirurgicaux

Super Cut

Mit einer Schneide gezahnt
With one blade serrated
Con una lama dentellata
Con una hoja dentada
Avec une lame dentèle

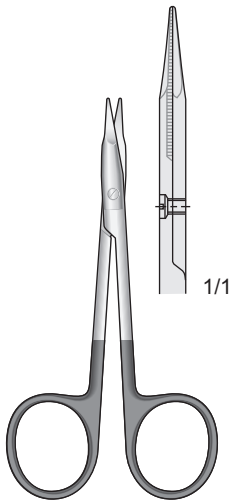

STEVENS
FM-302
105 mm

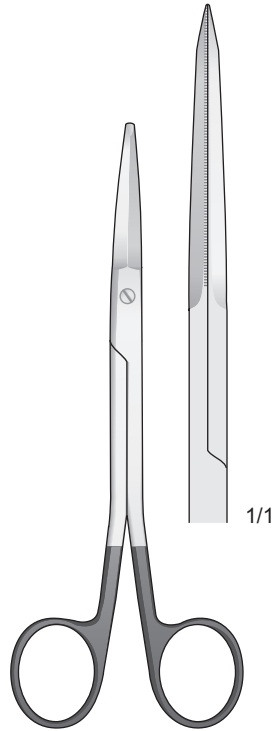

FACE-LIFT
FM-308
160 mm

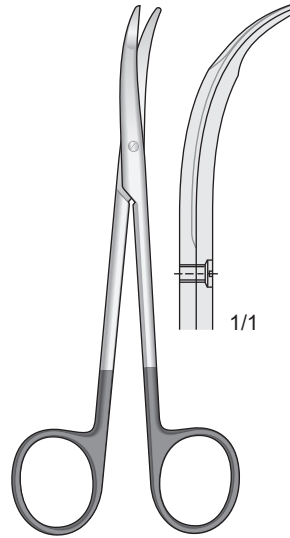

FOMON
FG-163
140 mm

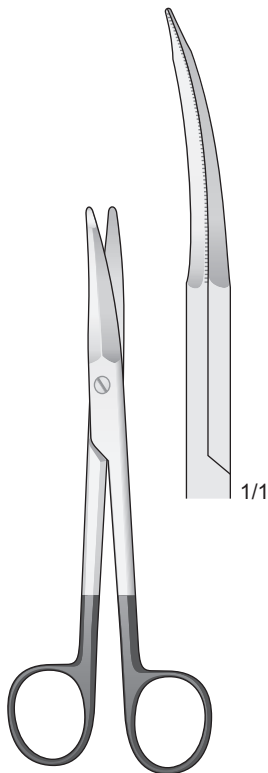

REES-FACE-LIFT
FM-304
150 mm

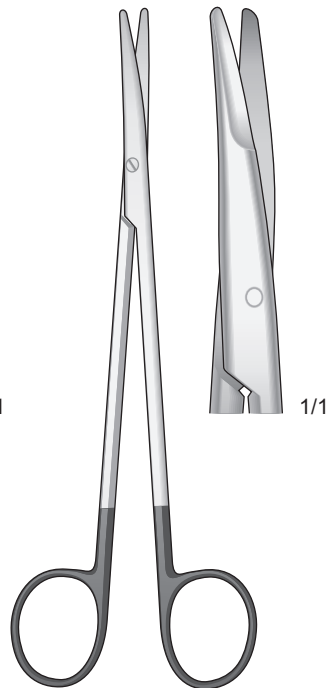

METZENBAUM
FM-318/FM-319
180 mm

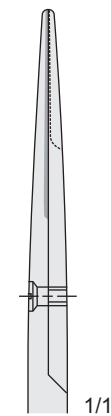

FM-318
180 mm

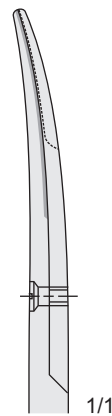

FM-319
180 mm

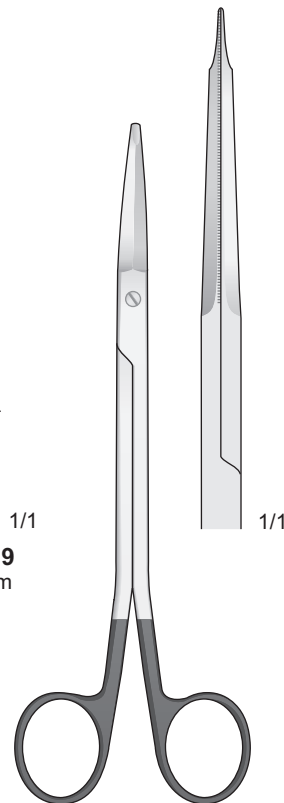

FREEMANN-KAYE
FM-332
180 mm

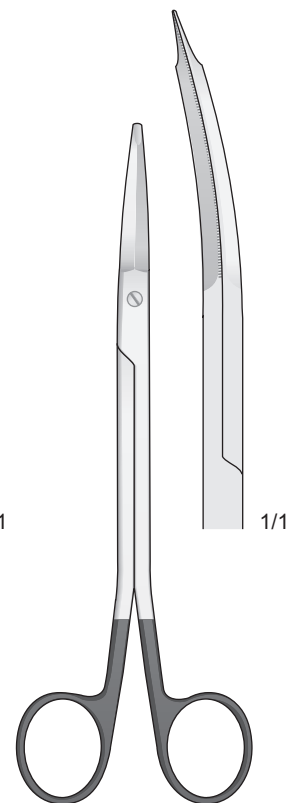

FREEMANN-KAYE
FM-333
180 mm

Vergoldet Super Cut

Mit einer Schneide gezahnt
With one blade serrated
Con una lama dentellata
Con una hoja dentada
Avec une lame dentèle

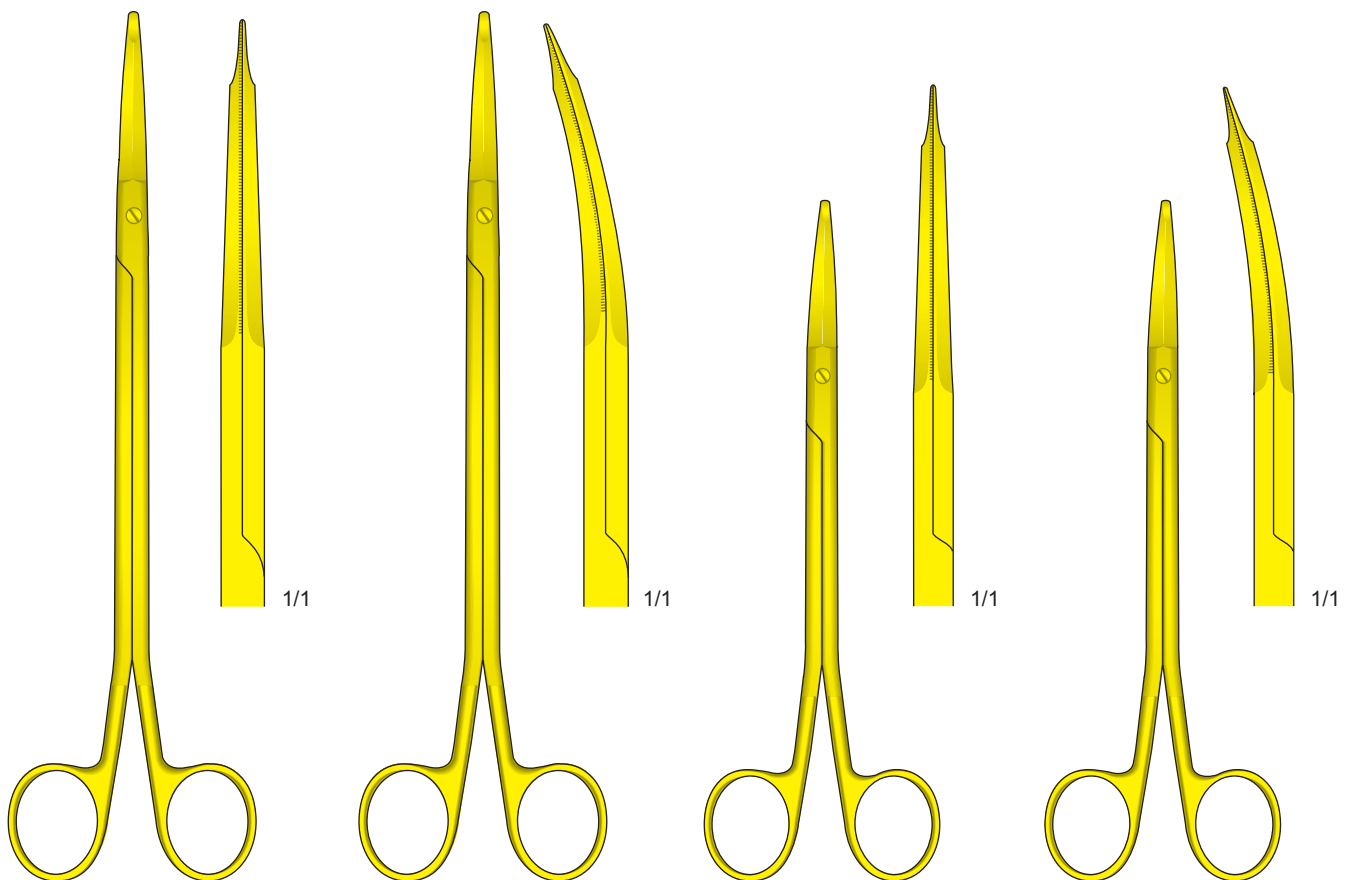

GORNEY
FM-313G
230 mm

GORNEY
FM-314G
230 mm

FREEMAN KAYE
FM-332G
180 mm

FREEMAN KAYE
FM-333G
180 mm

Scheren Gezahnt

Serrated scissors

Forbici dentellate

Tijeras dentadas

Ciseaux dentelé

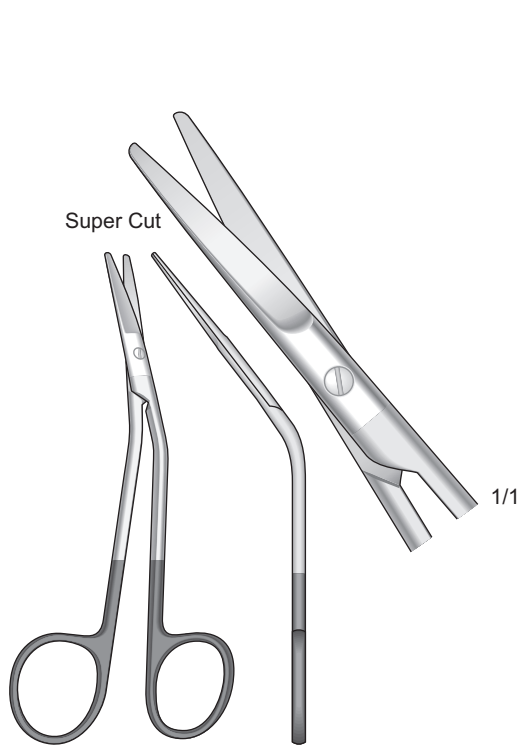

FOMON
FG-192
130 mm

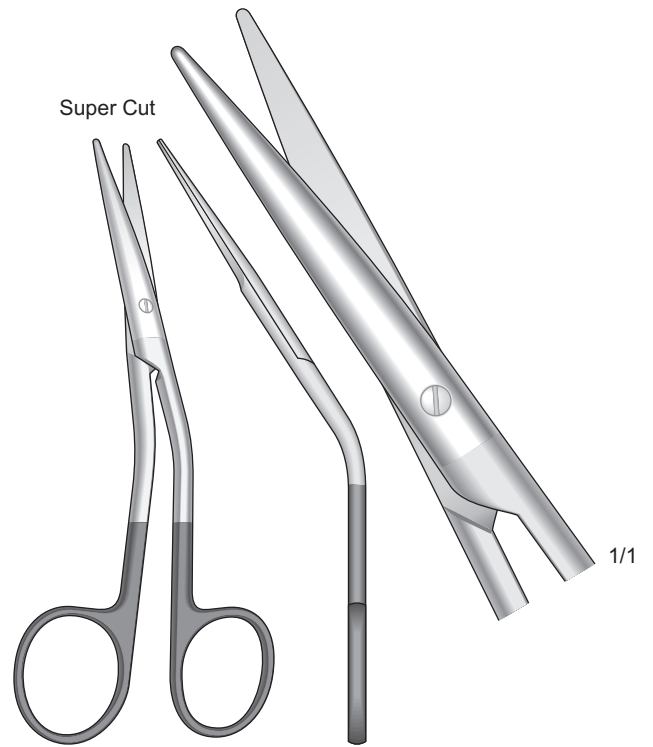

COTTLE
FG-193
160 mm

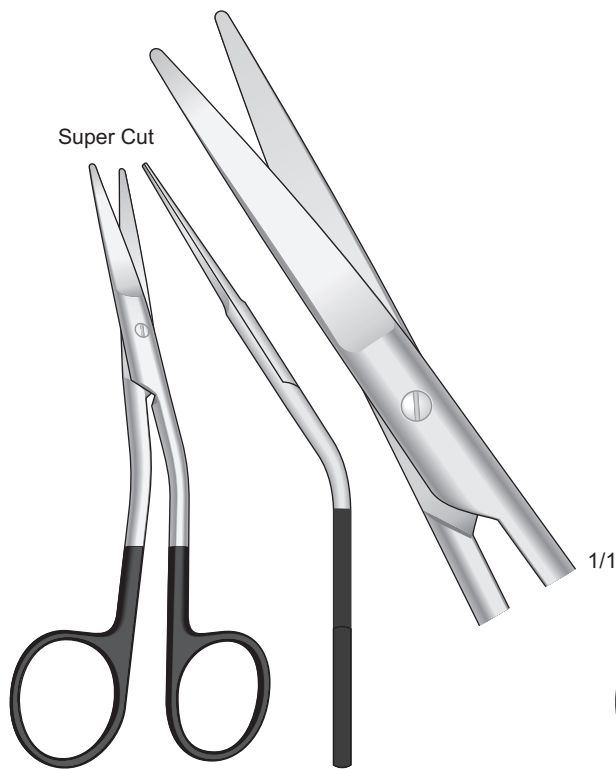

COTTLE
FG-194
160 mm

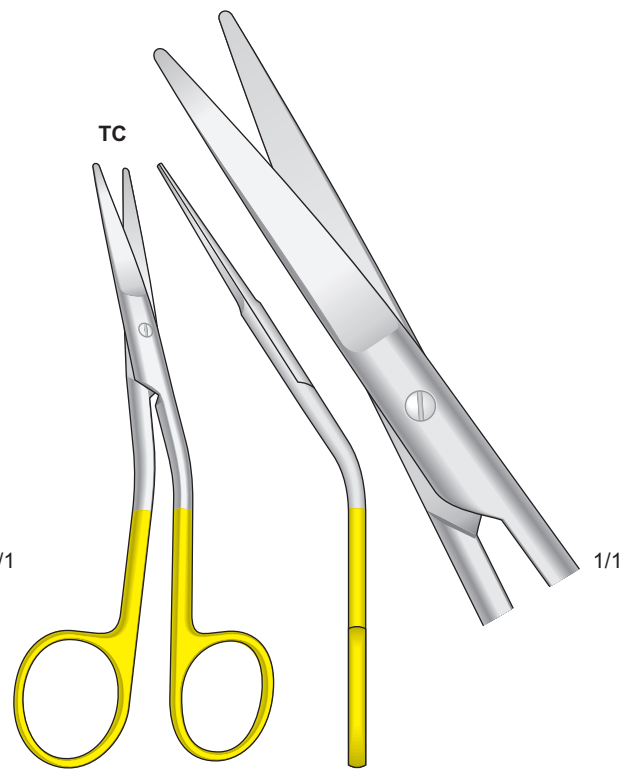

COTTLE
FG-195
160 mm

Knochensplitterscheren

Bone cutting scissors

Forbici ossivore

Tijeras para huesos

Ciseaux à os

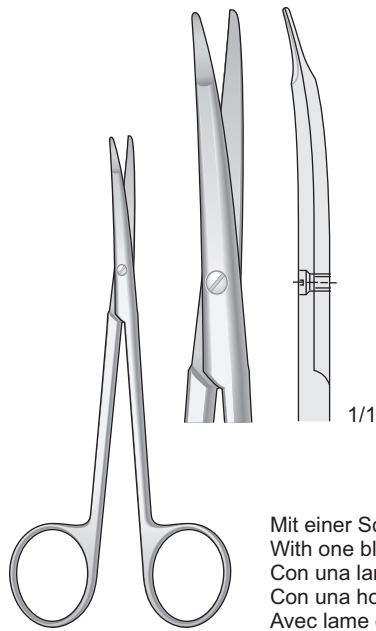

Mit einer Schneide gezahnt
With one blade serrated
Con una lama zigrinata
Con una hoja dentada
Avec lame dentée

**KILNER
FG-121**
130 mm

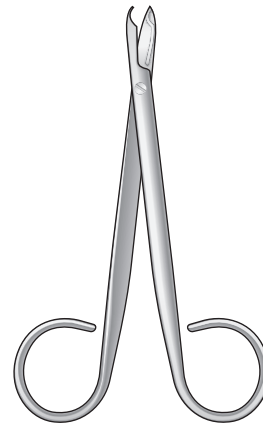

SC-3
110 mm

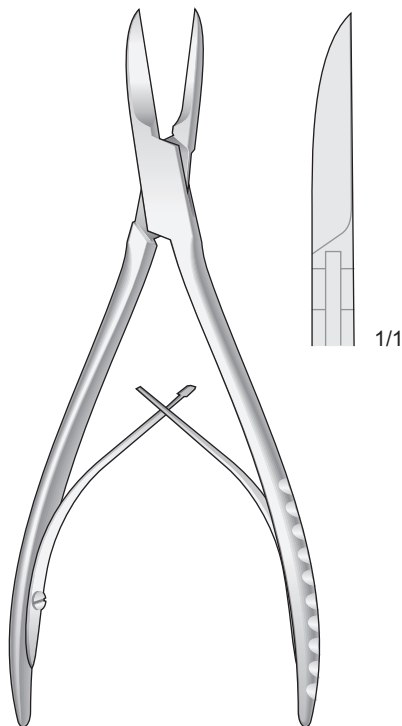

**COTTLE-KAZANJIAN
FO-95**
190 mm

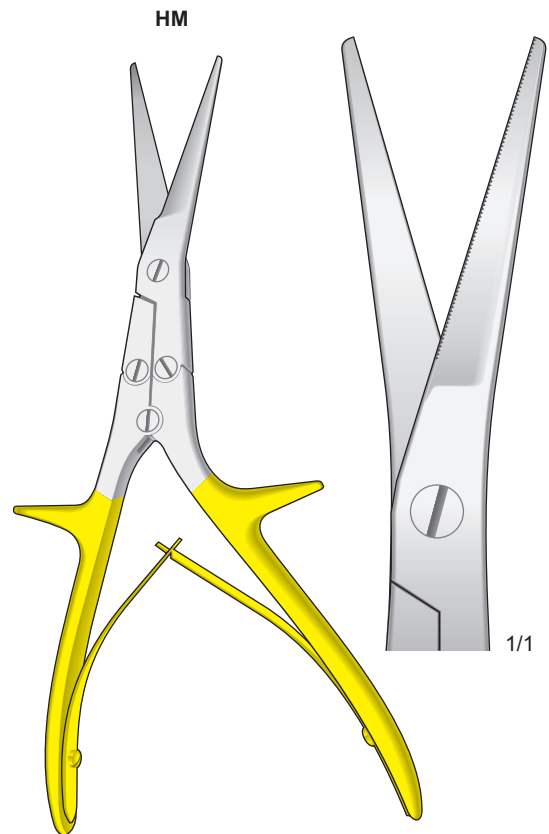

**GORNEY
FO-190**
205 mm

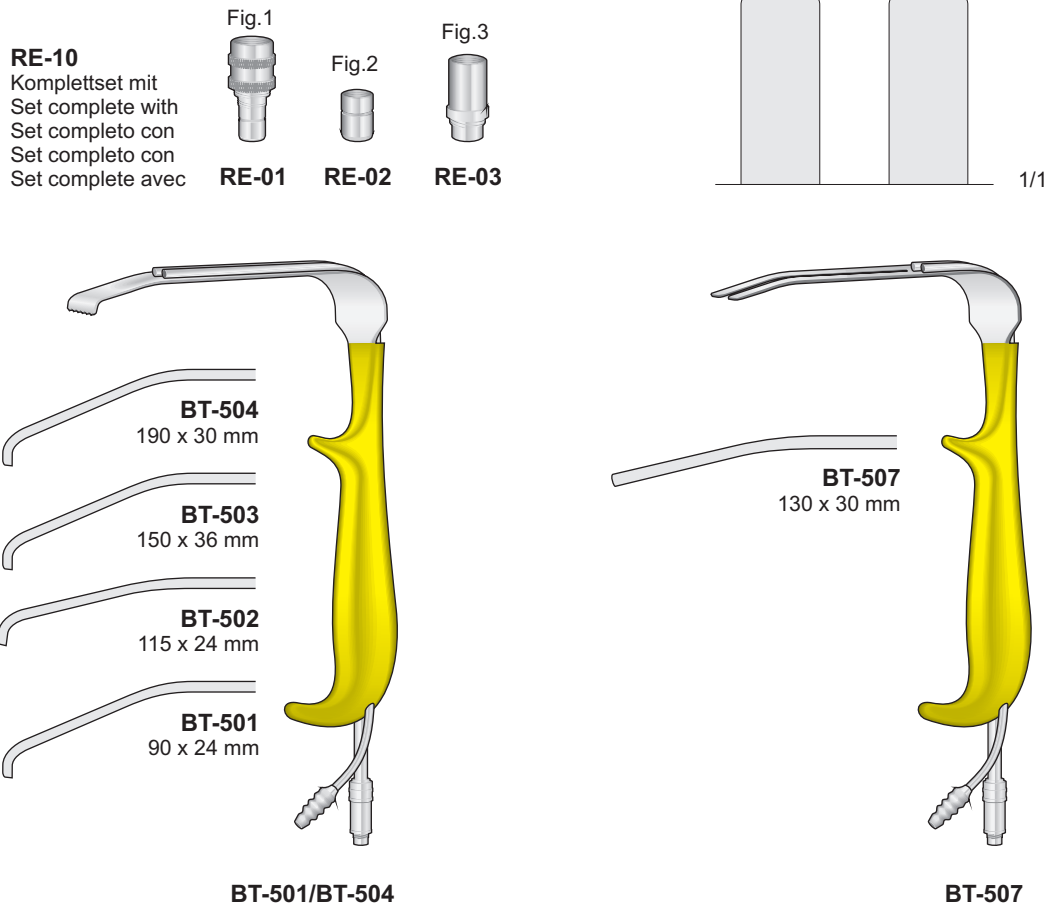
Wundhaken mit
FiberoptikstabRetractors with
Fiber opticDivaricatore con
fibra otticaRetractor con
iluminación de luz fríaEcarteur avec illumination
à lumière froide

Fiber Optic Retractor - Divaricatore a fibra ottica

Advantages - Vantaggi

Sterilizable. Removable. Protected fiber-optic piece
Oval Shaped optic end for great light field
Retractor with concave blade for added operative space and visibility
Equiped with universal adapters WOLF, STORZ, OLYMPUS
German Stainless Steel, cool Fiber optic light sterilizable till 134°C

Asportabile e sterilizzabile. Fibra ottica protetta su tutto lo strumento per garantire una maggiore stabilità e sicurezza del movimento
Progettato e realizzato per garantire all'operatore massima maneggevolezza ed alta intensità di luce fredda in tutte quelle situazioni che comportano una visione operatoria a cielo chiuso
Grazie ai suoi tre attacchi universali WOLF, STORZ e OLYMPUS, facilita l'operatore nel potersi muovere da un ambito ambulatoriale ad uno ospedaliero senza dover rinunciare a un campo visivo indispensabile per la sua professione
Acciaio tedesco Fiber Optic luce fredda, Sterilizzabile fino a 134°C

Sizes - Misure dei divaricatori:

BT-501 90 x 24 mm	RE-01 Fig.1
BT-502 115 x 24 mm	RE-02 Fig.2
BT-503 150 x 36 mm	RE-03 Fig.3
BT-504 190 x 30 mm	RE-10 Set Fig.1 + Fig.2 + Fig.3

Wundhaken mit
Fiberoptikstab oval

Retractors with
Fiber optic oval

Divaricatori a
fibre ottiche ovale

Retractor con
iluminación de luz fría

Ecarteur avec
illumination à lumière froide

Spiral Breast Retractor
Retrattore della mammella a spirale

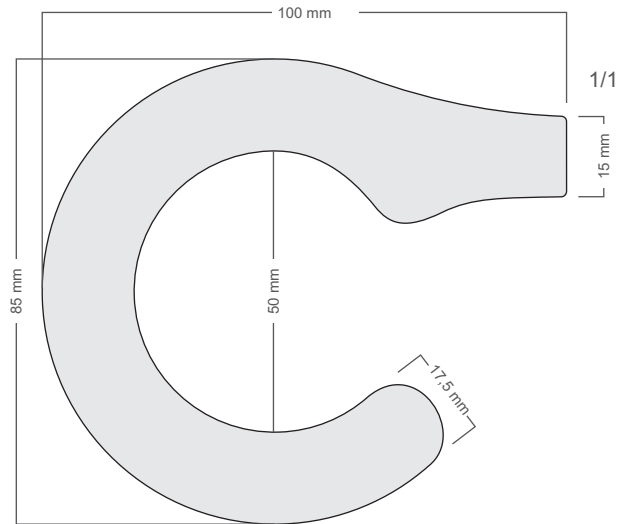
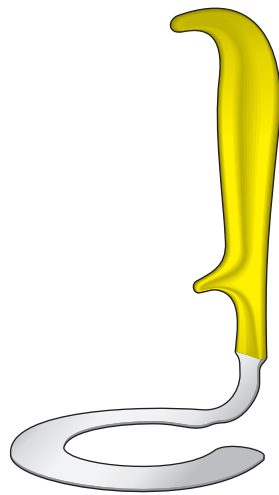

BT-506
150 mm

Wundhaken mit Fiberoptikstab
Retractors with Fiber optic illumination
Divaricatori con illuminazione a fibre ottiche
Retractor con iluminación de luz fría
Ecarteur avec illumination à lumière froide

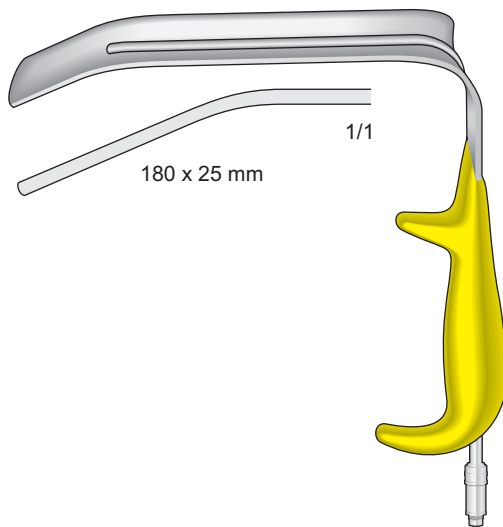

BT-505

Wundhaken
Retractor
Divaricatore
Separador
Ecarteur

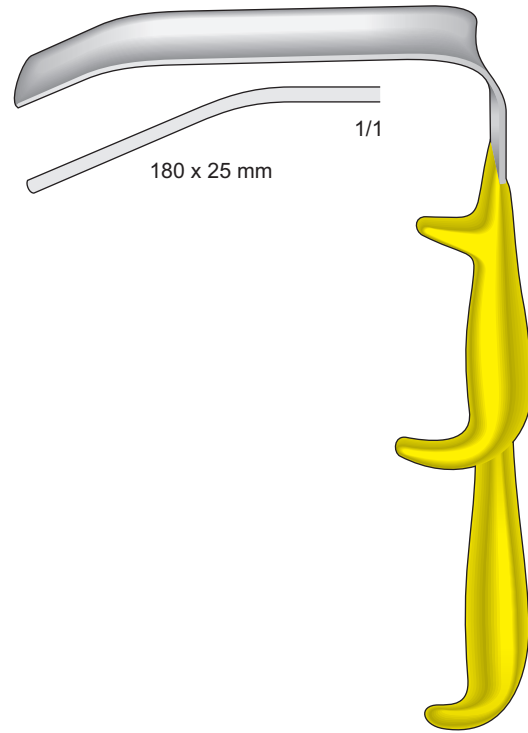

BT-510

**Glasfaser
-technik****Optical Fiber
Technology****Tecnologia
a fibre ottiche****Tecnología de
fibra óptica****Technologie de
la fibre optique****HT-LED**

LED Coldlight Technology for medical applications
Tecnologia LED a luce fredda per applicazioni mediche



Lamp: Lampada	LED-HTS
Lifespan: Durata	> 40.000 h
Light guide connection: Collegamento luce	System STORZ
Safety Standard: Standard di sicurezza	IEC 60601-1, 60601-1-2
Power Supply: Alimentazione	100-240VAC 50/60 Hz
Power consumption: Consumo di energia	30 W
Dimensions (WxHxD): Dimensioni (LxAxP)	360x80x310 mm
Weight: Peso	Approx. 5,8 Kg

HT-180X

ColdLight Source Technology for medical applications
Fonte di luce fredda per applicazioni mediche

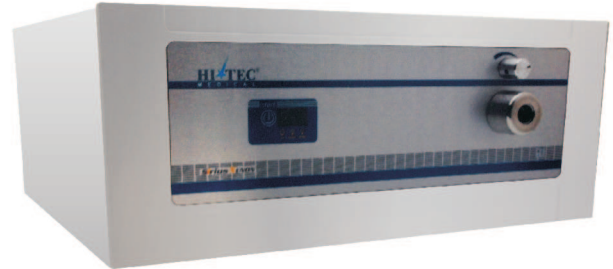

Lamp: Lampada	Xenon 180 W
Light guide connection: Collegamento luce	System STORZ
Safety Standard: Standard di sicurezza	IEC 60601-1, 60601-1-2
Power Supply: Alimentazione	100-240VAC 50/60 Hz
Power consumption: Consumo di energia	230 W
Dimensions (WxHxD): Dimensioni (LxAxP)	360x150x310 mm
Weight: Peso	Approx. 11,0 Kg

HT-250S

ColdLight Source Technology for medical applications
Fonte di luce fredda per applicazioni mediche



Lamp: Lampada	2 x Halogen 250 W
Color Temperature: Temperatura di colore	Approx. 3200K
Light guide connection: Collegamento luce	System STORZ
Power Supply: Alimentazione	115-230VAC 50/60 Hz
Power consumption: Consumo di energia	265 W
Dimensions (WxHxD): Dimensioni (LxAxP)	360x150x310 mm
Weight: Peso	Approx. 11,0 Kg

HT-131K

Fiber Optic Cable
Cavo a fibra ottica



Cable Diameter: Diametro del cavo	3,5 mm
Length: Lunghezza	230 cm
Sterilization: Sterilizzazione	Autoclavable

HT-134K

Fiber Optic Cable
Cavo a fibra ottica



Cable Diameter: Diametro del cavo	3,5 mm
Length: Lunghezza	300 cm
Sterilization: Sterilizzazione	Autoclavable

Wundhaken

Retractors

Divaricatori

Separadores

Ecarteurs

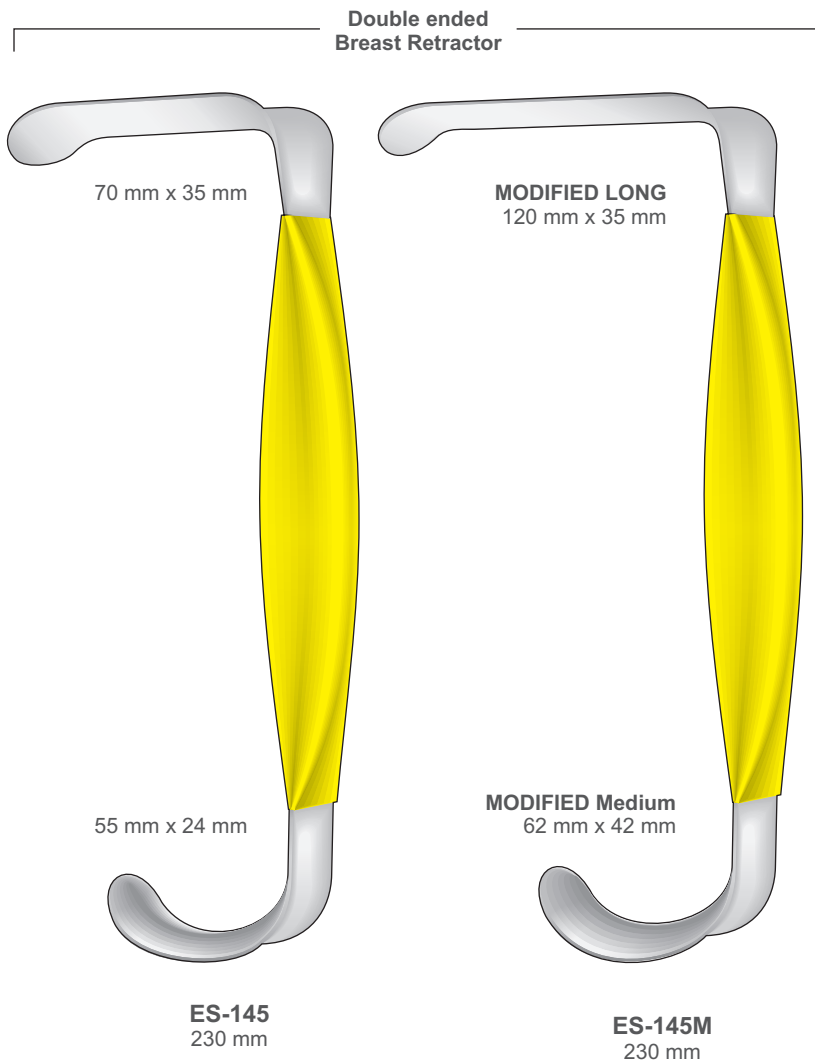

Mit Fiberoptikstab
With Fiber optic
Con illuminazione a fibre ottiche
Con iluminación de luz fría
Avec illumination à lumière froide

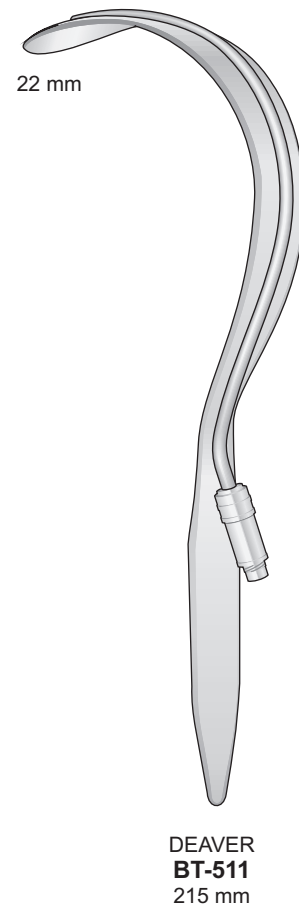

Dissector

Dissector

Dissettori

Disecadores

Dissecteur

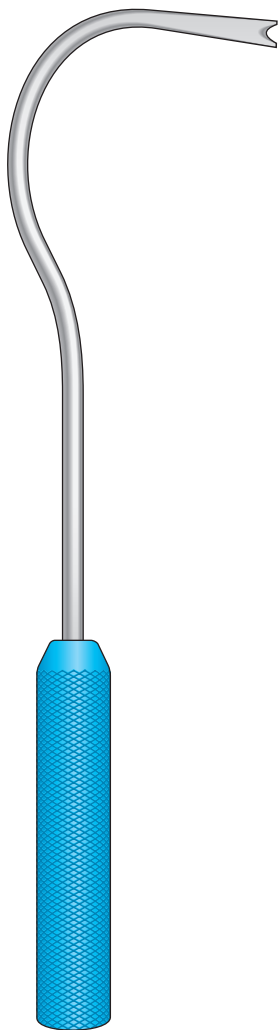

FOERSTER
ES-146
270 mm

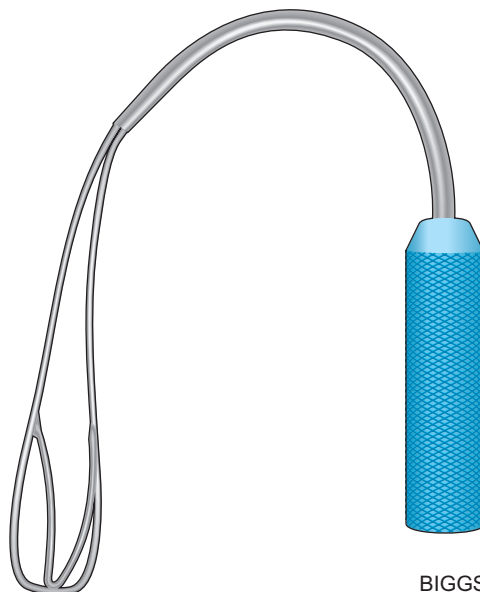

BIGGS
ES-148



AGRIS-DINGMAN
ES-147
360 mm

Areola-Marker

Areola Marking

Marca Areola

Apuntar Areola

Couteaux à mamelles



Brustheber
Breast Elevator
Elevatore mammario
Elevador mamario
Élévateur mammaire

ES-450
280 mm

Scharf - Sharp
Taglienti - Cortante
Tranchant

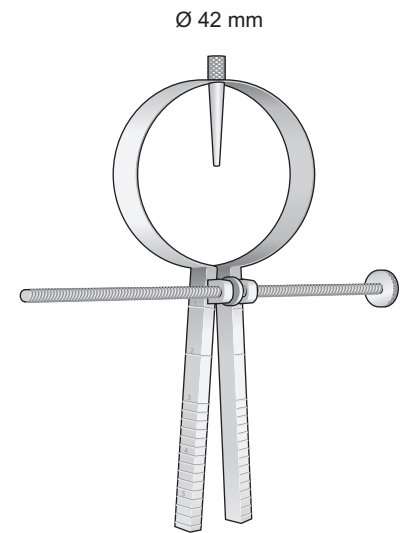
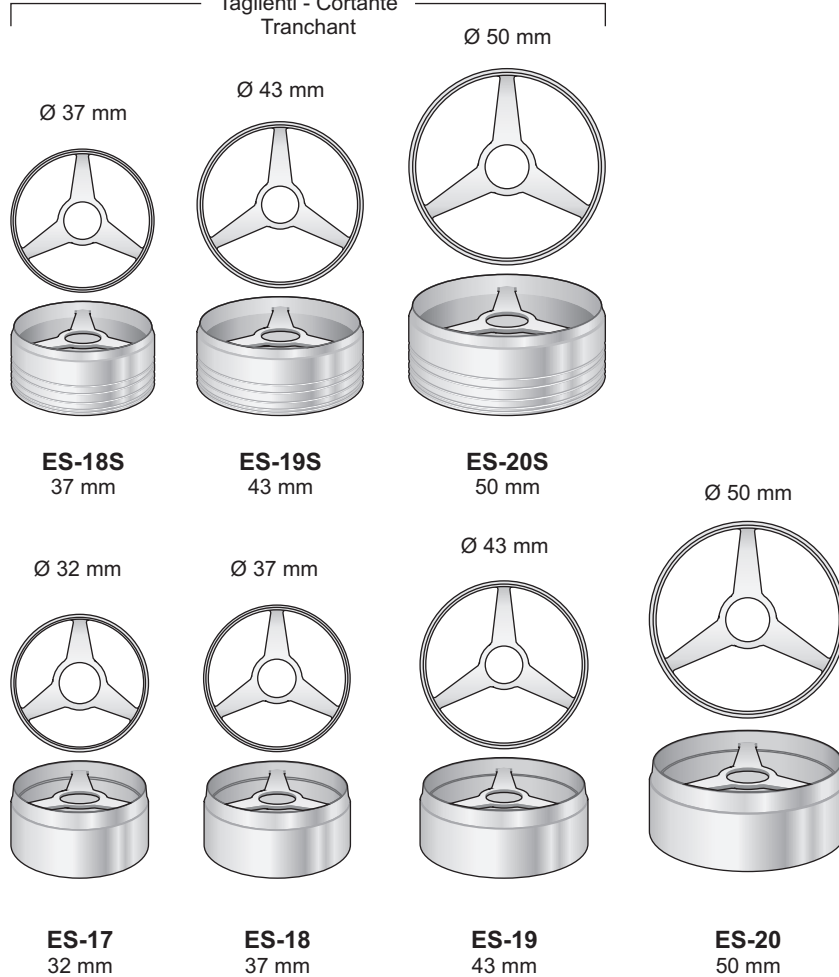

Ø 42 mm

ES-165
110 mm

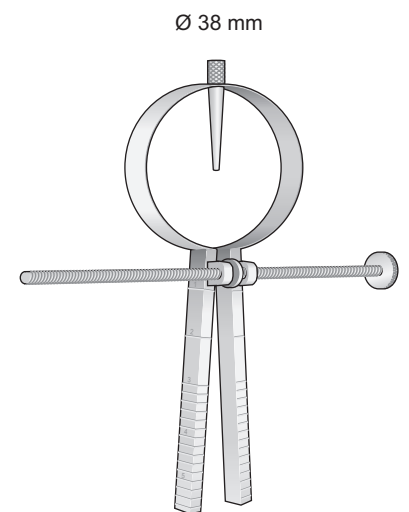

Ø 38 mm

ES-164
105 mm

Dissektoren

Dissectors

Dissettori

Separadores

Dissecteurs

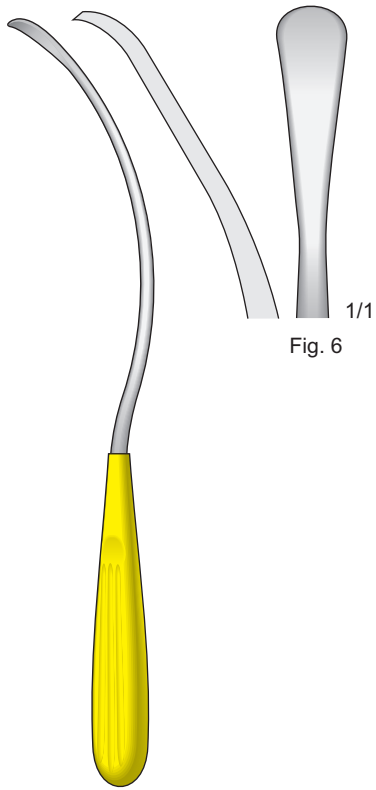

Fig. 6

ES-136
255 mm

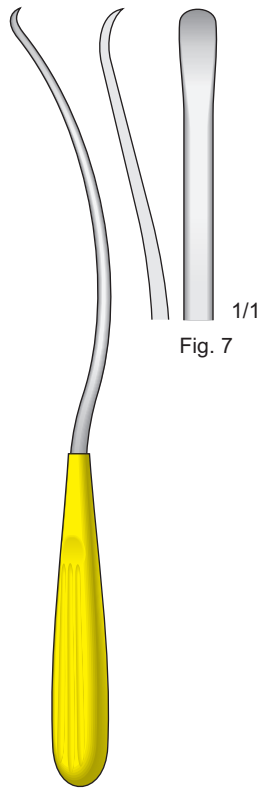

Fig. 7

ES-137
260 mm

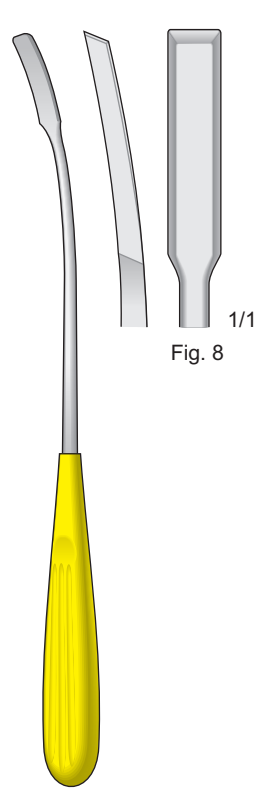

Fig. 8

ES-138
250 mm

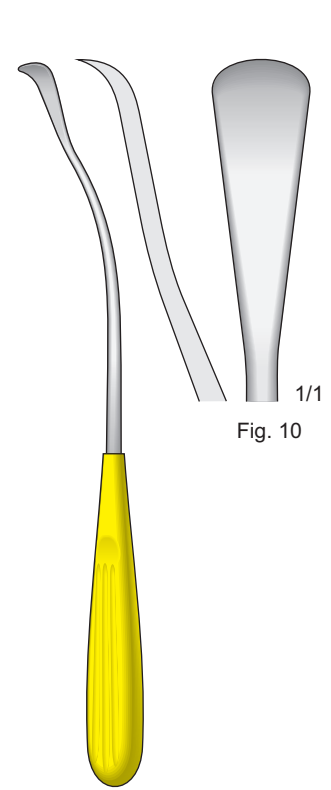

Fig. 10

ES-139
230 mm

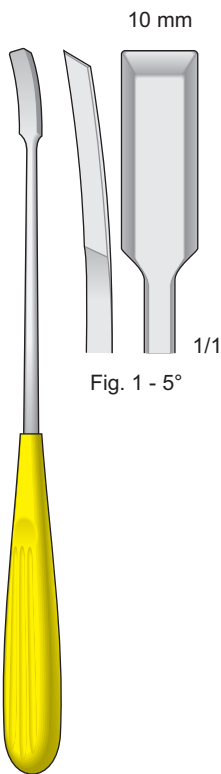

Fig. 1 - 5°

ES-131
240 mm

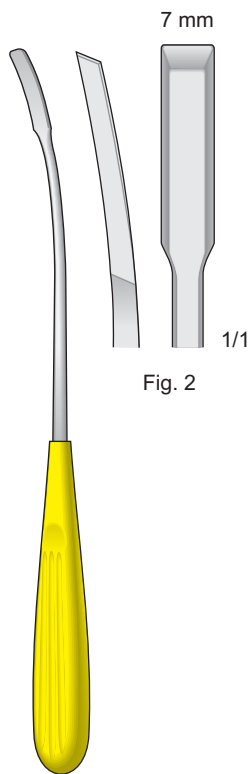

Fig. 2

ES-132
240 mm

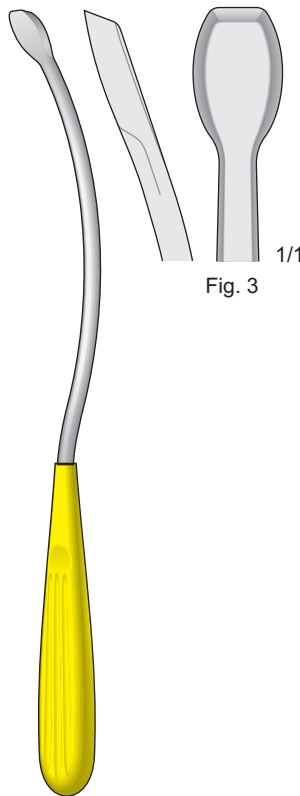

Fig. 3

ES-133
265 mm

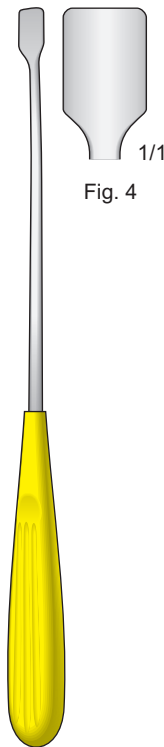

Fig. 4

ES-134
250 mm

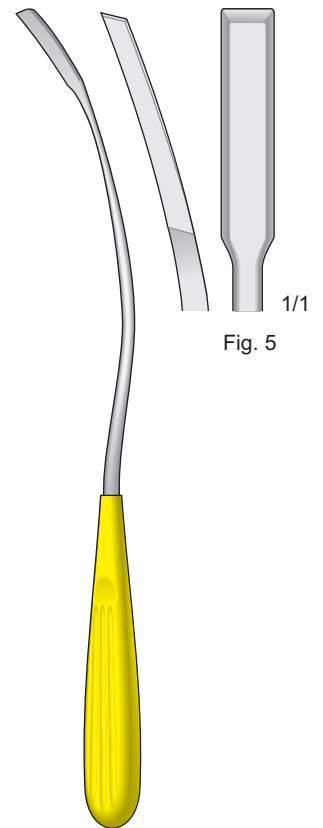

Fig. 5

ES-135
280 mm

Dissektoren
Elevatoren

Dissectors
Elevators

Dissettori
Elevatori

Separadores
Elevadores

Dissecteurs
Elevateurs

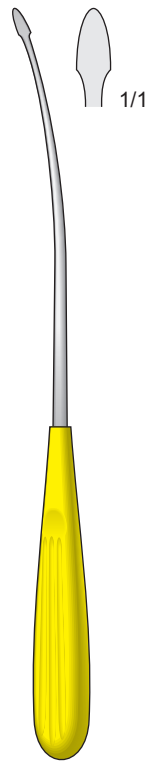

ES-216
235 mm

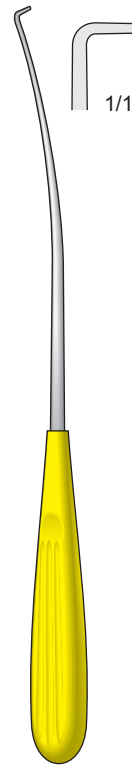

ES-217
235 mm

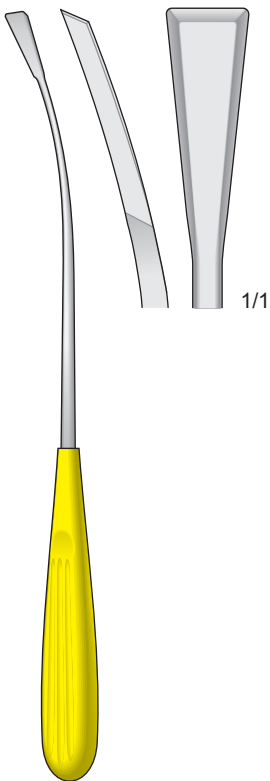

ES-211
240 mm

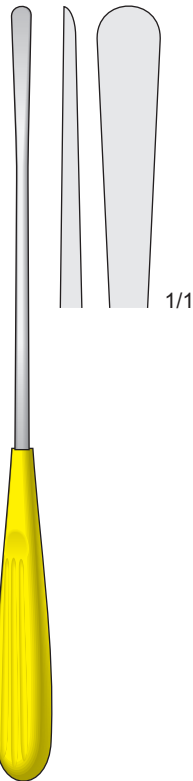

ES-212
240 mm

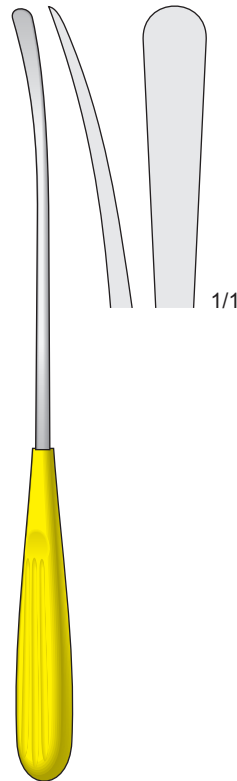

ES-213
240 mm

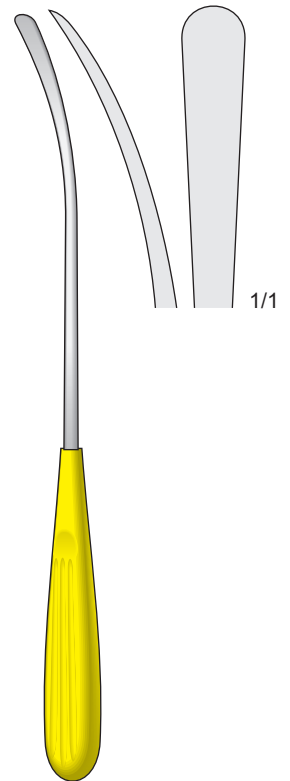

ES-215
240 mm

**Dissector
Wundhaken**

**Dissector
Retractors**

**Dissettori
Divaricatori**

**Disecadores
Separadores**

**Dissecteur
Ecarteur**

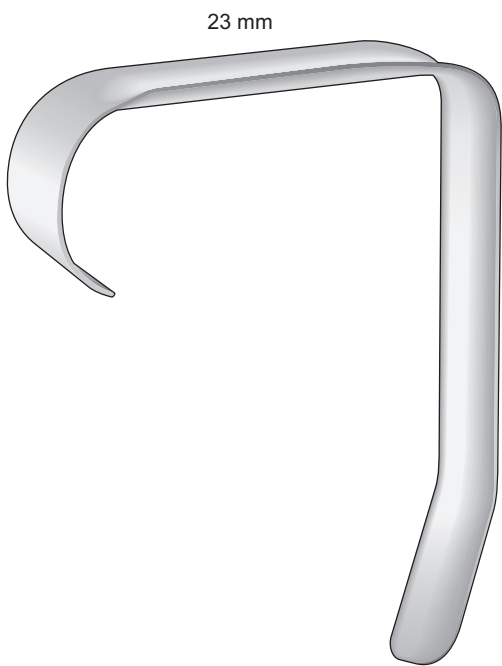

**FACE-LIFT
ES-163**
120 mm



**CONVERSE
DO-207**
50 mm

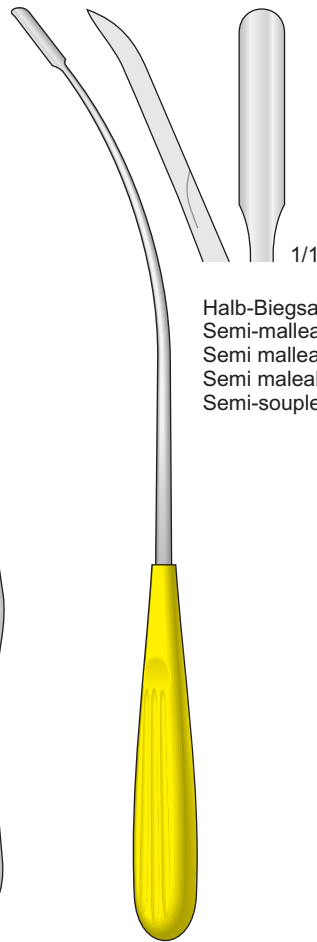

ES-219
270 mm



ES-144
330 mm

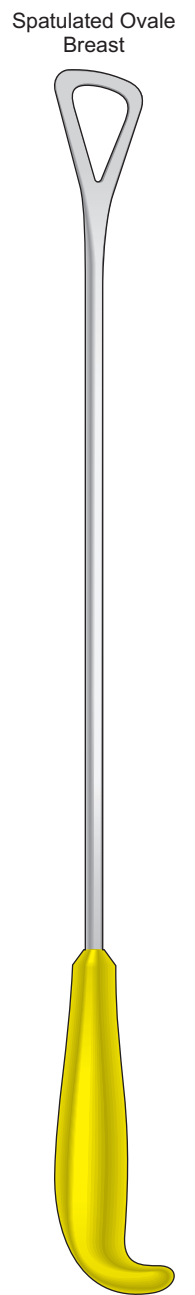

ES-149
390 mm

Elevator für Lifting

Face Lifting Elevator

Scollatore per lifting

Separador para lifting

Décolleur à lifting

Rostfrei - Stainless Steel
Acciaio - Acero
Acer

Schwarz Verchromt
Black anodized
Cromato nero
Cromado en negro
Chromé noir

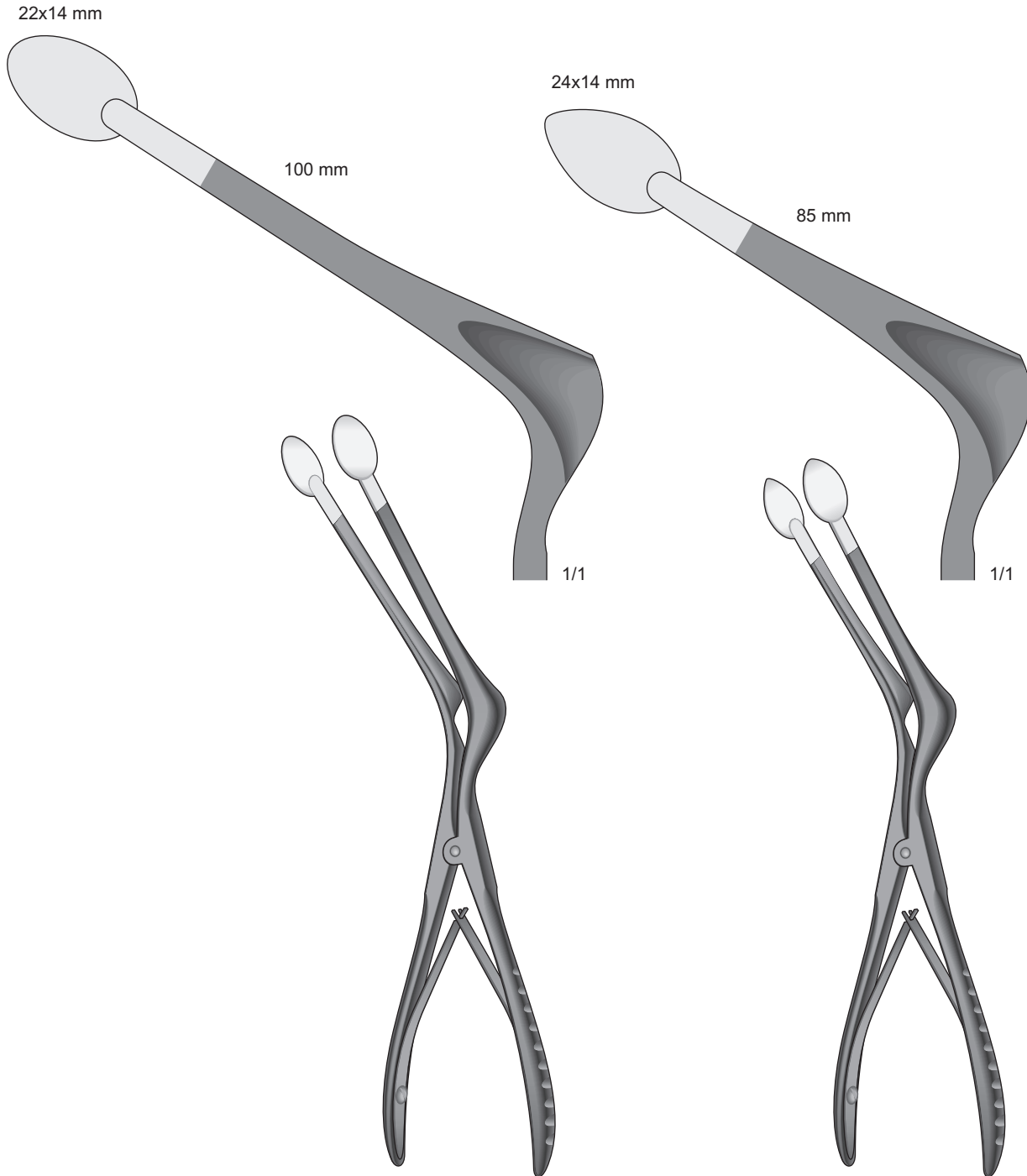

MENEGHINI
OM-230
200 mm

MENEGHINI
OM-231
180 mm

Elevator für Lifting

Face Lifting Elevator

Scollatore per lifting

Separador para lifting

Décolleur à lifting

Protettore oculare
Conchiglia protettiva per Blefaroplastica

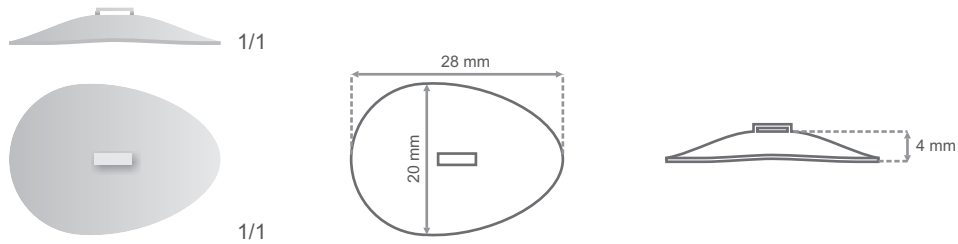

NK-400

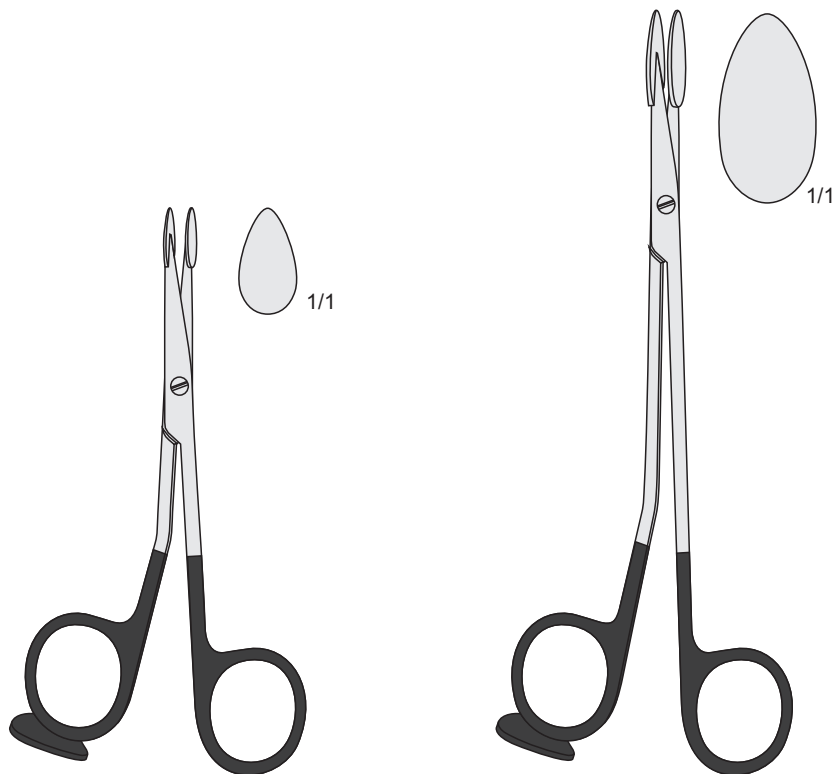

FM-400
130 mm

FM-401
180 mm

Wundhaken mit
Fiberoptikstab oval

Retractors with
Fiber optic oval

Divaricatore a
fibra ottica ovale

Retractor con
iluminación de luz fría

Ecarteur avec
illumination à lumière froide

Sterilizable. Removable. Protected fiber-optic piece
Oval Shaped optic end for great light field
Retractor with concave blade for added operative space and visibility
Equiped with universal adapters WOLF, STORZ, OLYMPUS

Mit Absaugkanülen
With Suction Tube
Con aspirazione
Con aspiración
Avec aspiration

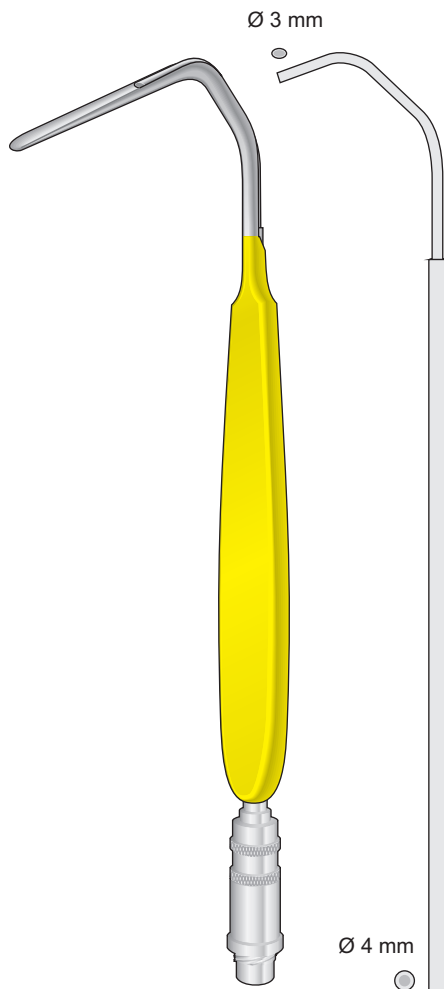
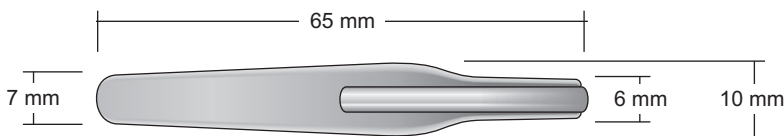

RE-10
Komplettset mit
Set complete with
Set completo con
Set completo con
Set complete avec

RE-01 RE-02 RE-03

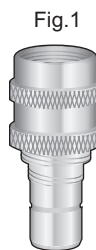

RE-01



RE-02



RE-03

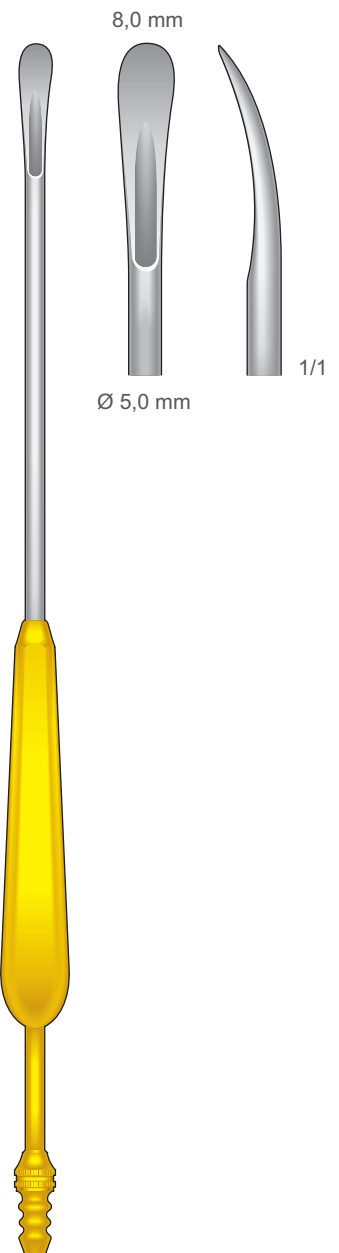

DO-401
185 mm

DO-401R
182 mm

ES-130
270 mm

Nasen Spekula

Nasal specula

Speculum nasali

Espéculos nasales

Spéculums nasaux

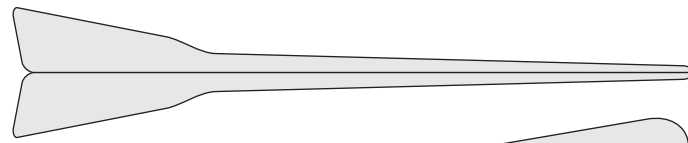

90 mm

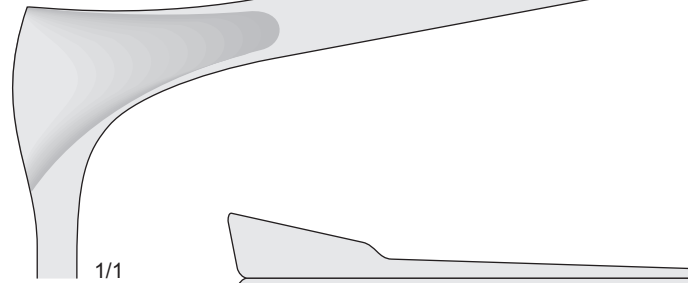

OM-192L
150 mm

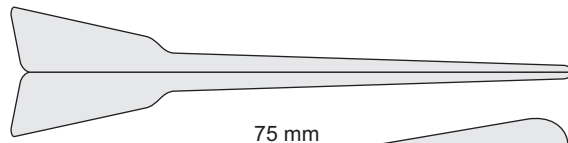

75 mm

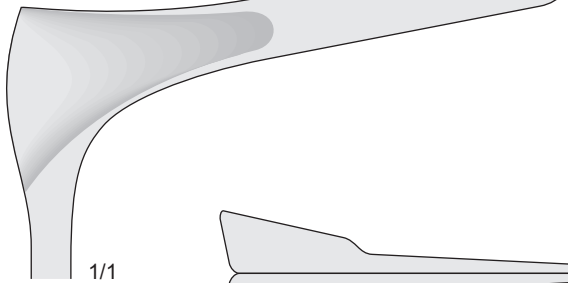

OM-192
150 mm

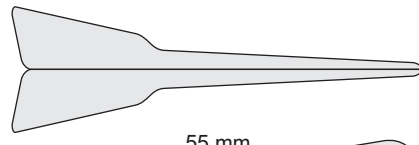

55 mm

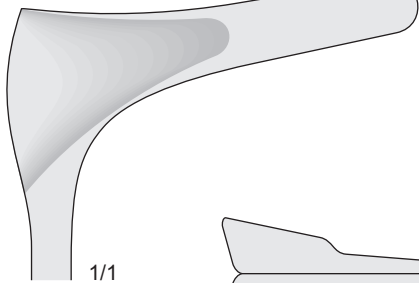

OM-191
140 mm

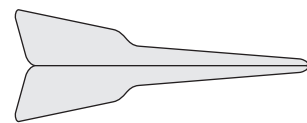

40 mm

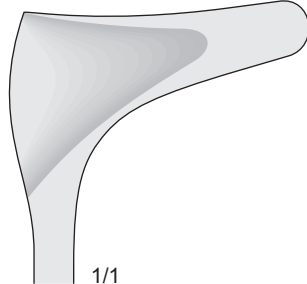

OM-190
130 mm

Dünnes Blatt
Thin valve
Valve piatte

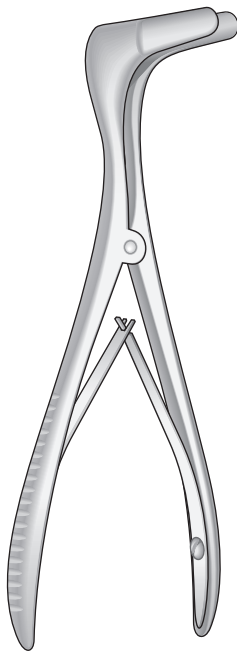

KILLIAN
OM-190/OM-192

Nasen Spekula

Nasal specula

Speculum nasali

Espéculos nasales

Spéculums nasaux

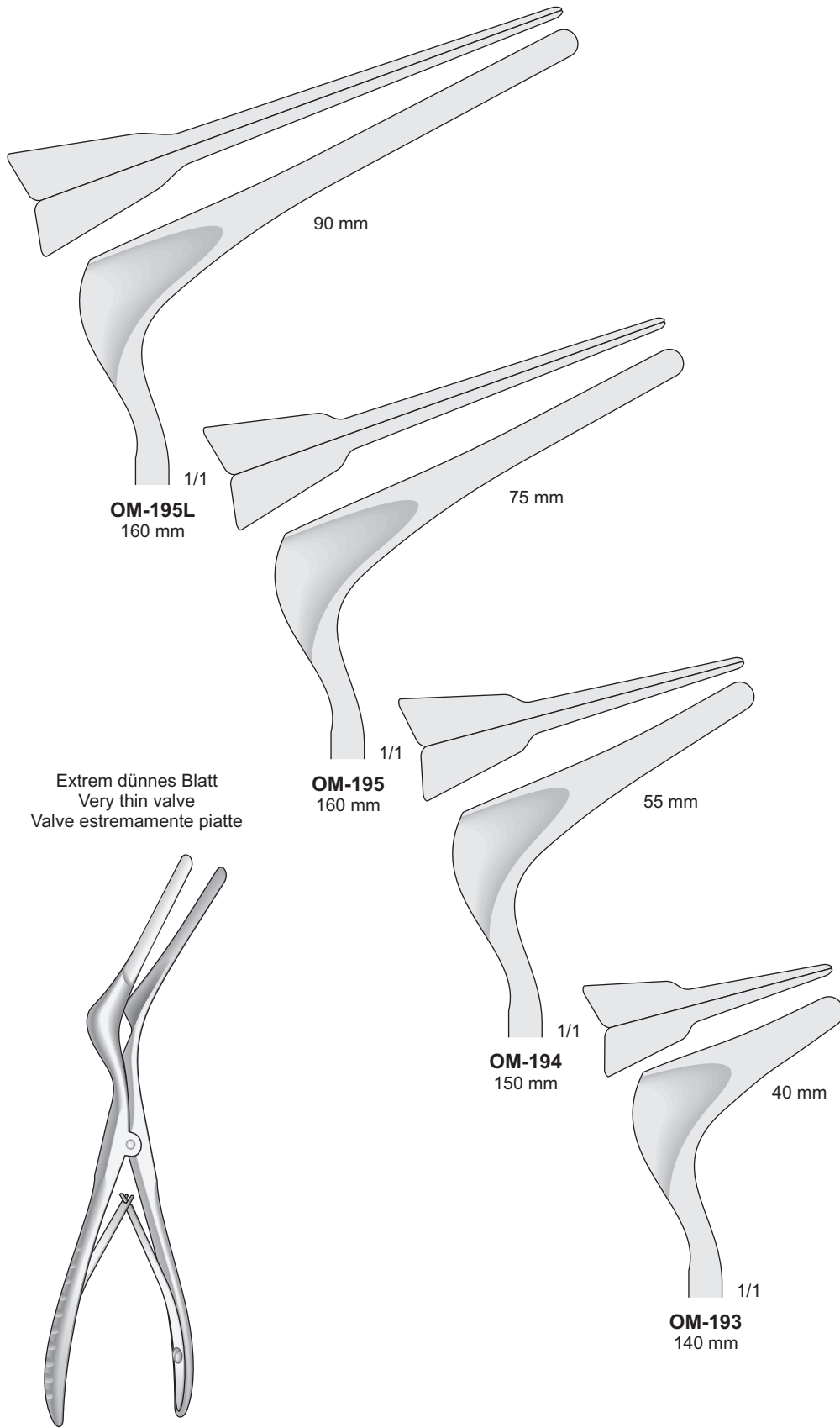

COTTLE
OM-193/OM-195

Nasen Spekula

Nasal specula

Speculum nasali

Espéculos nasales

Spéculums nasaux

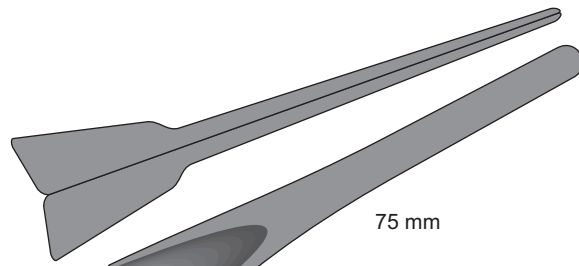

75 mm

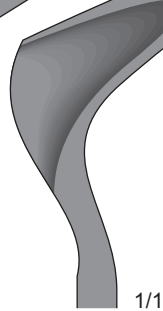

1/1

OM-198
160 mm

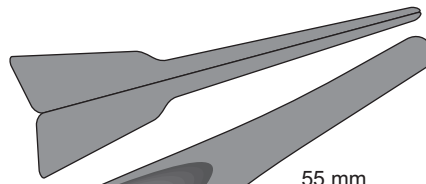

55 mm



1/1

OM-197
150 mm

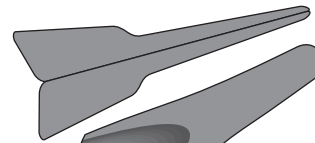

40 mm

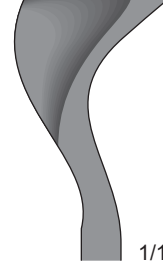

1/1

OM-196
140 mm

Schwarz Verchromt
Black Finish
Cromato nero

Extrem dünnes Blatt
Very thin valve
Valve estremamente piatta

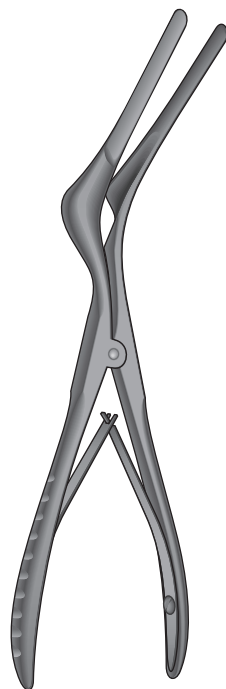

COTTLE
OM-196/OM-198

Nasen Spekula

Nasal specula

Speculum nasali

Espéculos nasales

Spéculums nasaux

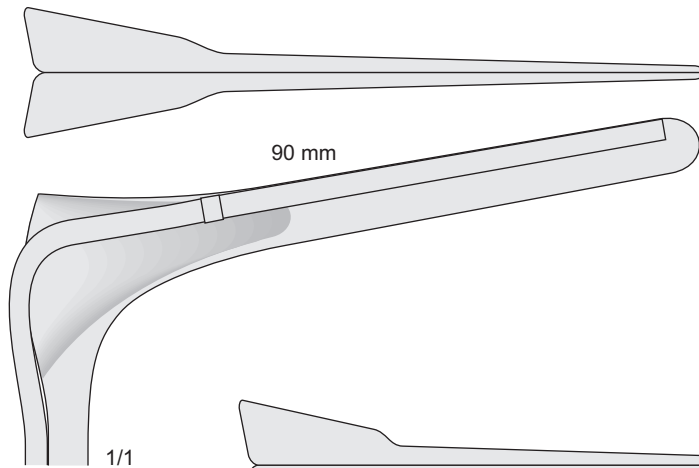

OM-243
150 mm

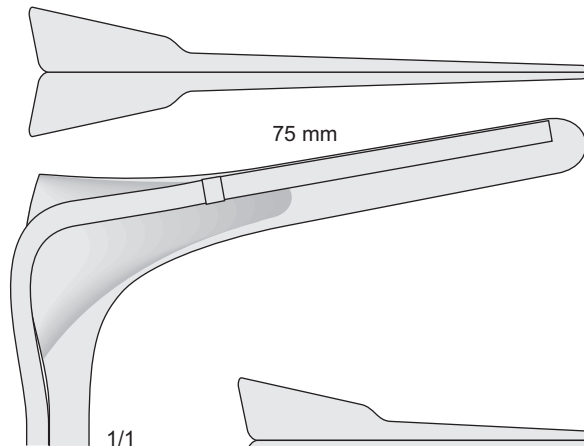

OM-242
150 mm

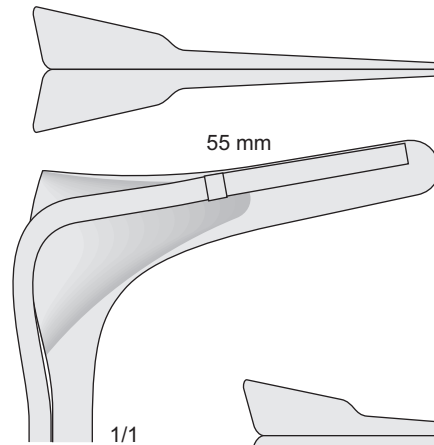

OM-241
140 mm

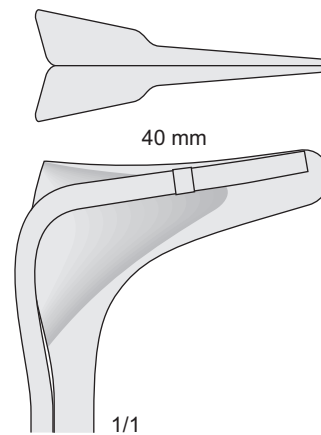

OM-240
130 mm

Dünnes Blatt
Thin valve
Valve piatte

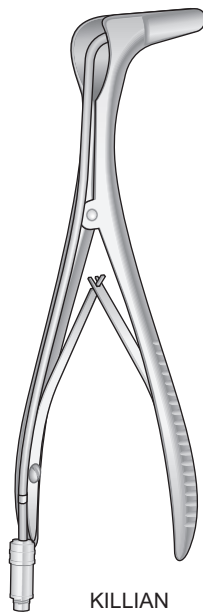

KILLIAN
OM-240/OM-243

Mit Faseroptikstab
With Fiber optic illumination
Con illuminazione a fibre ottiche
Con iluminación de luz fría
Avec illumination à lumière froide

Nasen Spekula

Nasal specula

Speculum nasali

Espéculos nasales

Spéculum nasaux

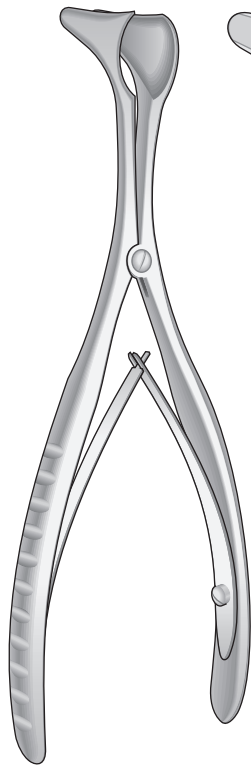

HARTMANN-HALLE
OM-108M
150 mm

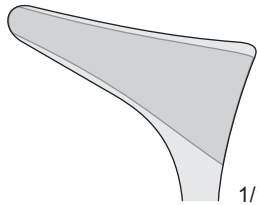

OM-108M
Fig. 2

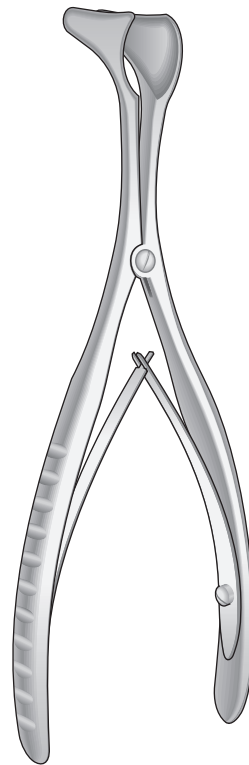

HARTMANN-HALLE
OM-106/OM-109
150 mm

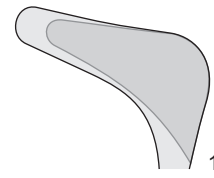

OM-106
Fig. 00

Kinder
Children
Bambini
Niños
Enfants

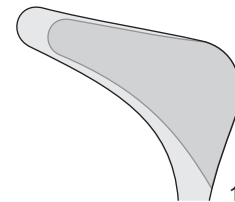

OM-107
27 mm
Fig. 1

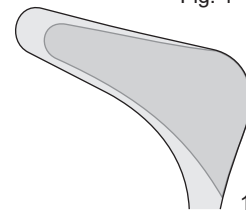

OM-108
31 mm
Fig. 2

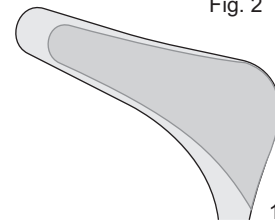

OM-109
35 mm
Fig. 3

Endoplastikinstrumente

Endoplastic
Instruments

Strumenti per
Endoplastica

Instrumentos para
Endoplastica

Instruments pour
Endoplastique

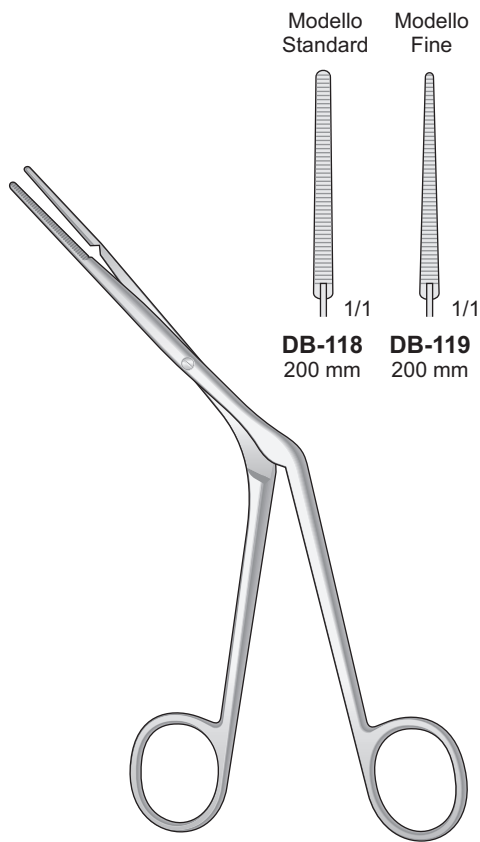

WESTMACOTT
DB-118/DB-119
200 mm

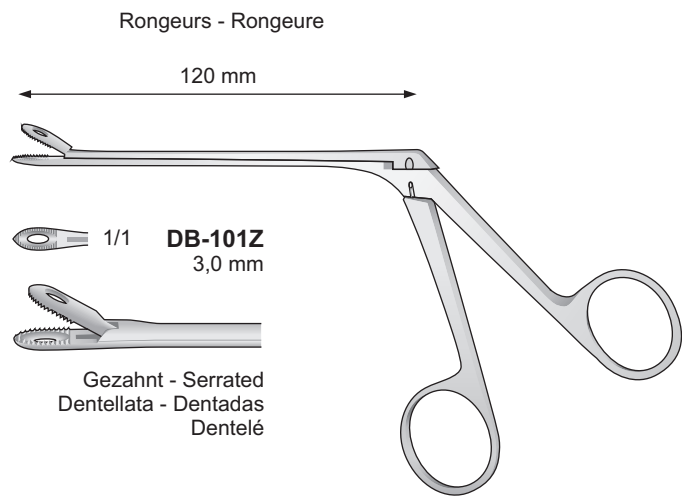

WEIL-BLAKESLEY
DB-101Z
190 mm

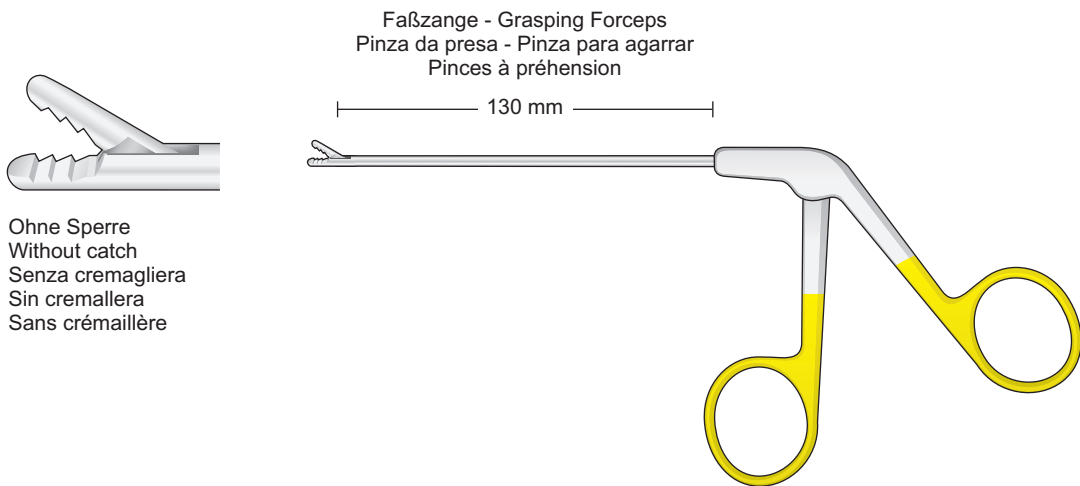

Ohne Sperre
Without catch
Senza cremagliera
Sin cremallera
Sans crémaillère

FO-350

Endoplastikinstrumente

Endoplastic
Instruments

Strumenti per
Endoplastica

Instrumentos para
Endoplastica

Instruments pour
Endoplastique

Gerade - Straight
Diritta - Recto - Droit



FO-370
Ø 2,7 mm

30° rechts - right
destra - derecha - droite



FO-371
Ø 2,7 mm

30° links - left - sinistra
izquierda - gauche



FO-372
Ø 2,7 mm

Hakenstanzen mit Schaufel - Hook Punches with Scoop
Pinze per biopsia con pala - Pinzas para biopsia con pala
Pincers à biopsie à pelle

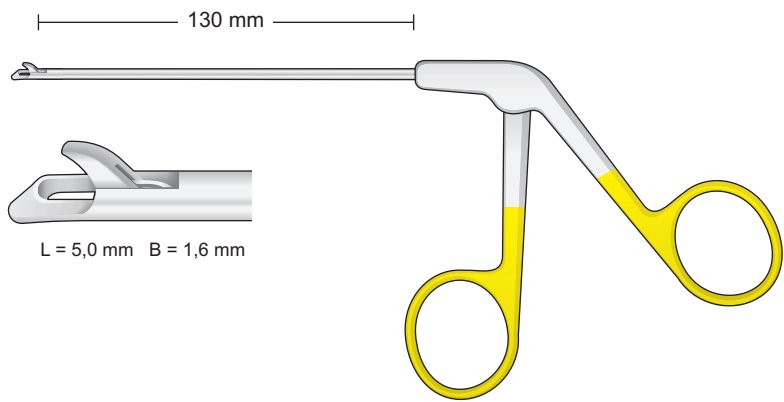

FO-370/FO-372

Gerade - Straight
Diritta - Recto - Droit



FO-390
Ø 2,7 mm

30° rechts - right
destra - derecha - droite



FO-391
Ø 2,7 mm

30° links - left - sinistra
izquierda - gauche



FO-392
Ø 2,7 mm

15° auf - up - sopra



FO-397
Ø 2,7 mm

Hakenschere - Hook Scissors
Pinze a gancio - Tijeras de gancho
Pincers - ciseaux

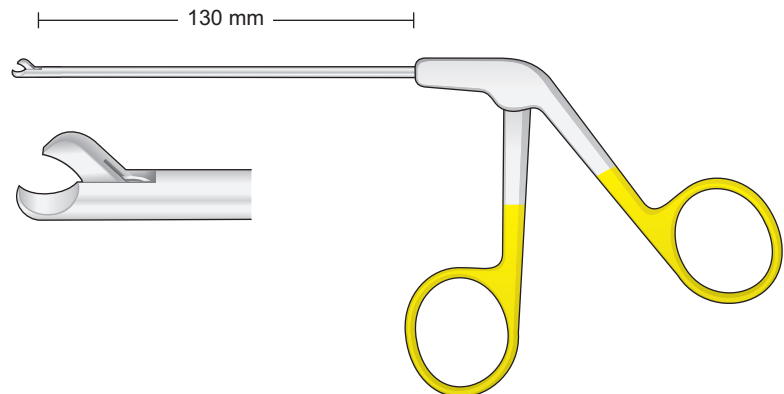

FO-390/FO-397

Feine Wundhäkchen

Fine Retractors

Divaricatori fini

Separadores finas

Ecarteurs très fins

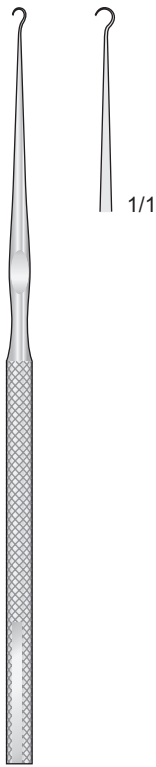

KILNER
BT-53
150 mm

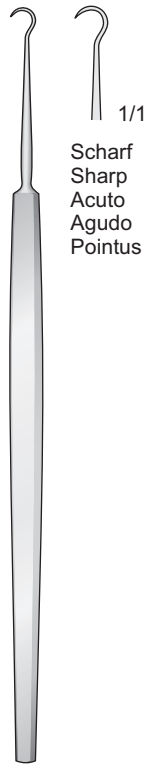

FRAZIER
BT-362 130 mm
BT-363 180 mm

Scharf
Sharp
Acuto
Agudo
Pointus

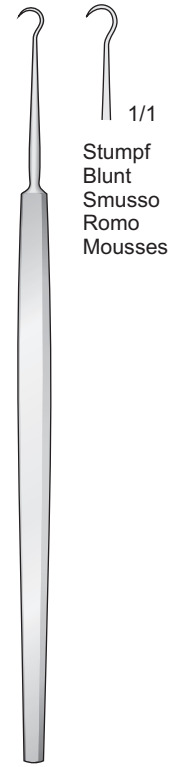

FRAZIER
BT-364 130 mm
BT-365 180 mm

Stumpf
Blunt
Smusso
Romo
Mousses

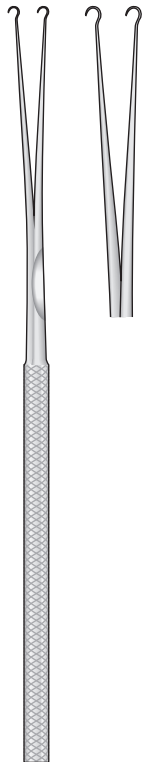

BARSKY
BT-370
150 mm

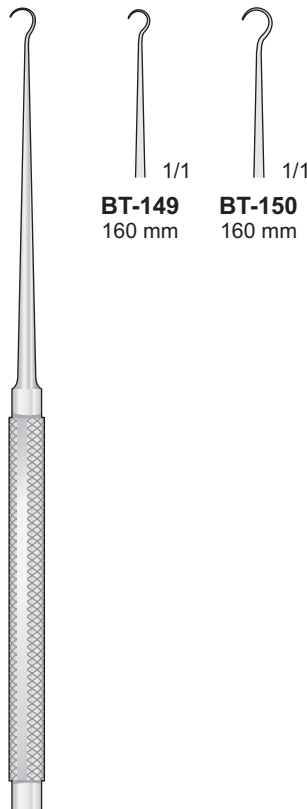

KLEINERT-KUTZ
BT-149/BT-150
160 mm

BT-149
160 mm

BT-150
160 mm

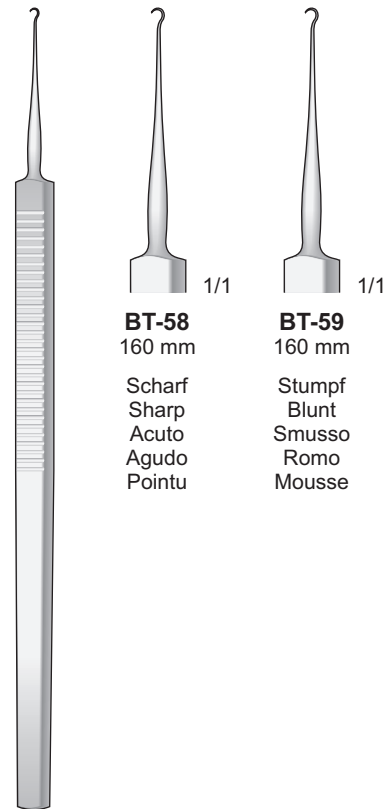

GRAEFE
BT-58/BT-59
160 mm

BT-58
160 mm

BT-59
160 mm

Scharf
Sharp
Acuto
Agudo
Pointu

Stumpf
Blunt
Smusso
Romo
Mousse

**Dissector
Wundhaken**



ES-110
125 mm

**Dissector
Retractors**



BT-21
110 mm

**Dissettori
Divaricatori**

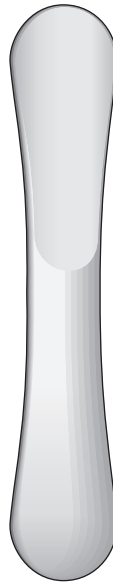

JAEGER
OM-09
110 mm

**Disecadores
Separadores**

Nasenflügelhaken
Alar Retractor
Divaricatore per alette nasali
Separador para las alas nasales
Ecarteur pour les ailes du nez

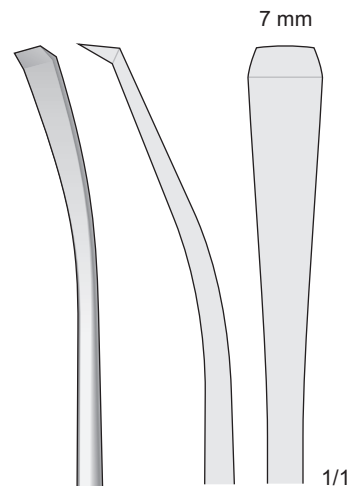

MENEGHINI
ES-221
215 mm

Measuring and Sculpturing
the lateral crus in open Rhinoplasty
Scultura delle crus laterali
nella Rinoplastica aperta

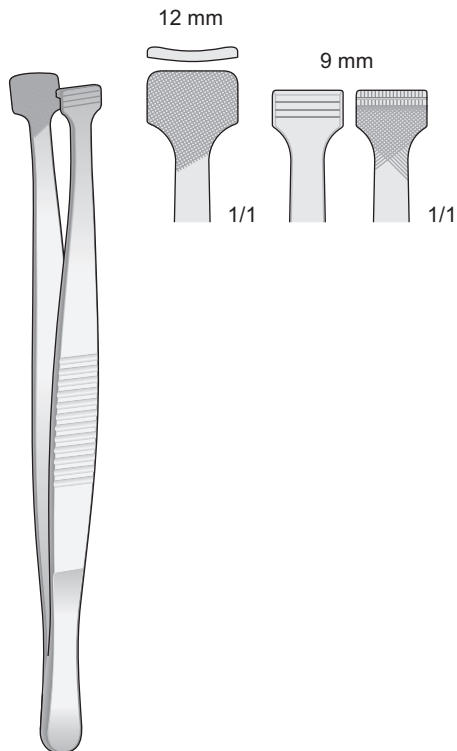

MENEGHINI
BD-350
125 mm

MICHELI-PELLEGRINI
FR-190
150 mm

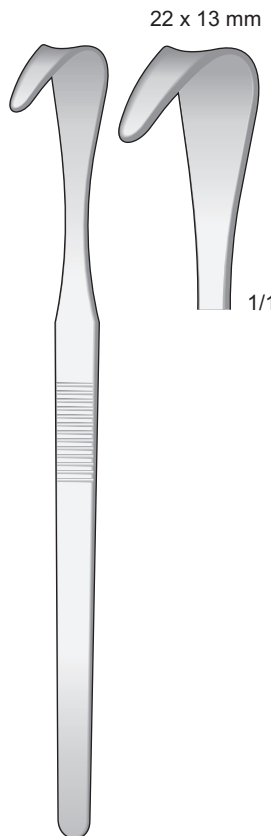

COTTLE
BT-138
150 mm

Osteotome

Osteotomes

Osteotomi

Osteòtomos

Ostéotomes



JOSEPH
FR-34
150 mm

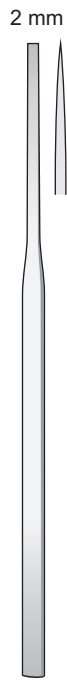

MINI-LAMBOTTE
FL-19
125 mm



TESSIER
FL-413/FL-416
160 mm



FL-413
2 mm



FL-414
3 mm



FL-415
5 mm



FL-416
7 mm

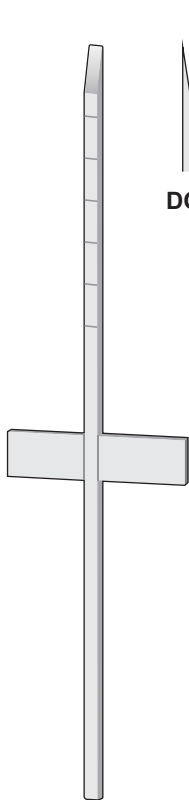

COTTLE
DO-219
180 mm

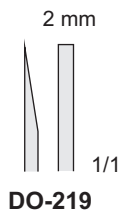

DO-219

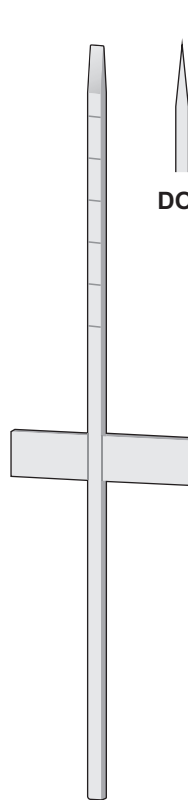

COTTLE
DO-228/DO-239
180 mm

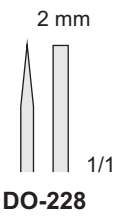

DO-228

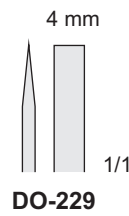

DO-229

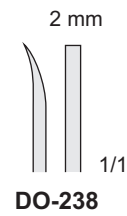

DO-238

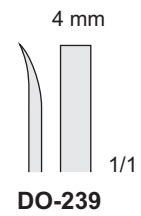

DO-239

Osteotome

Osteotomes

Osteotomi

Osteótomos

Ostéotomes

2 mm

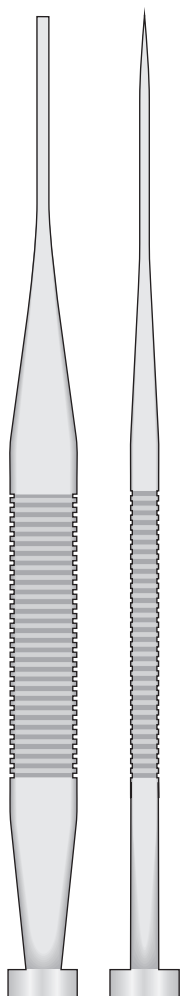

DO-113
170 mm

3 mm

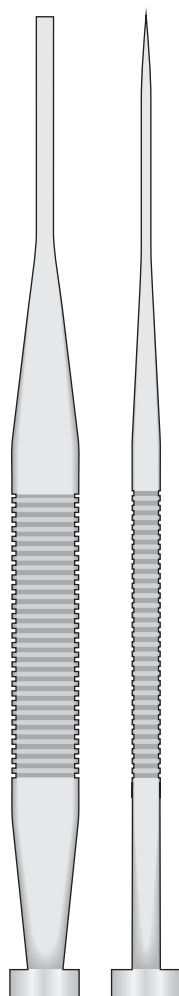

DO-114
170 mm

4 mm

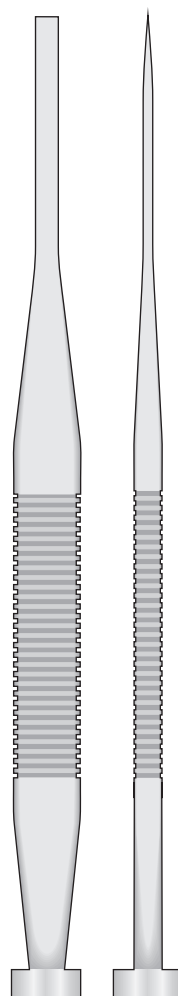

DO-115
170 mm

4 mm

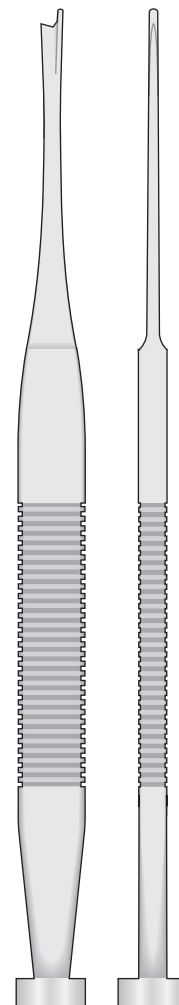

DO-116
170 mm



DO-135
185 mm

Osteotome

Osteotomes

Osteotomi

Osteòtomos

Ostéotomes

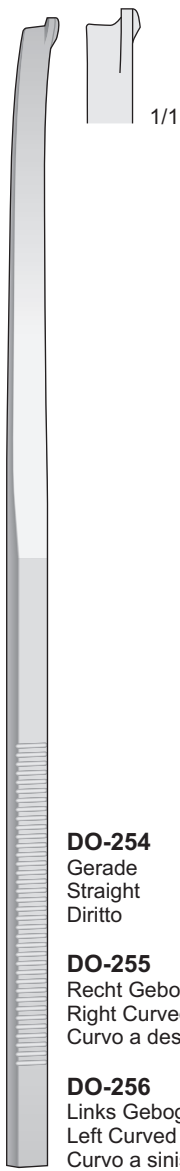

GUNTER
DO-254/DO-256
200 mm

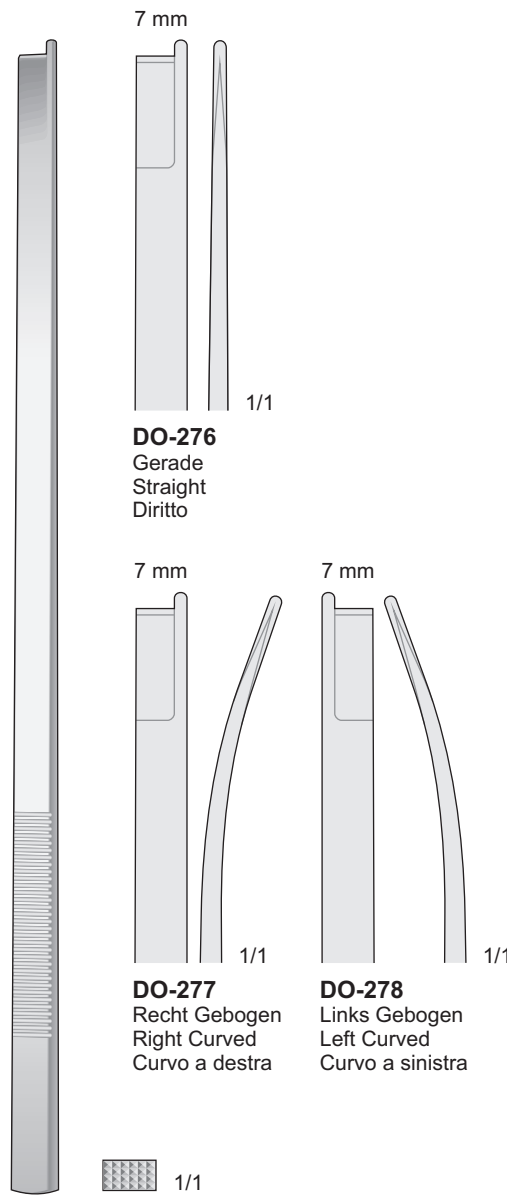

NEIVERT-ANDERSON
DO-276/DO-278
205 mm

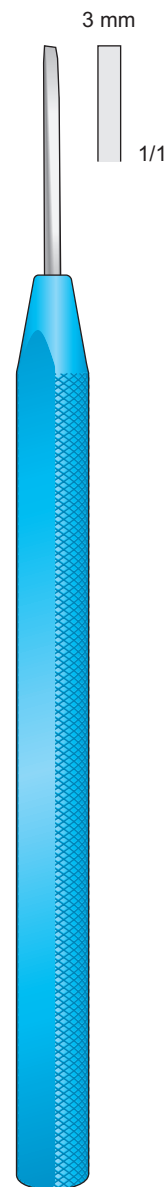

REES
DO-275
205 mm

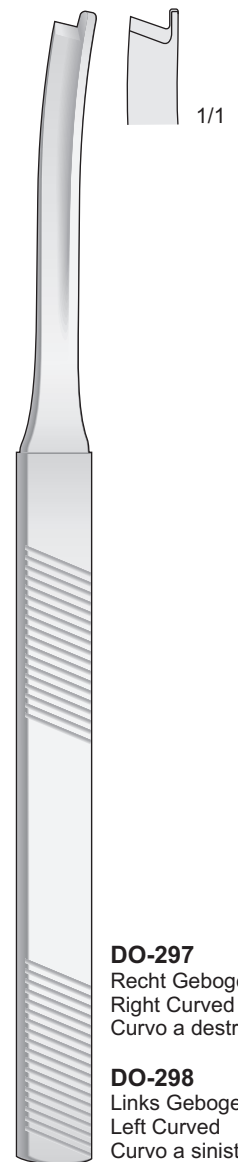

RISTOW
DO-297/DO-298
205 mm

Osteotome

Osteotomes

Osteotomi

Osteòtomos

Ostéotomes

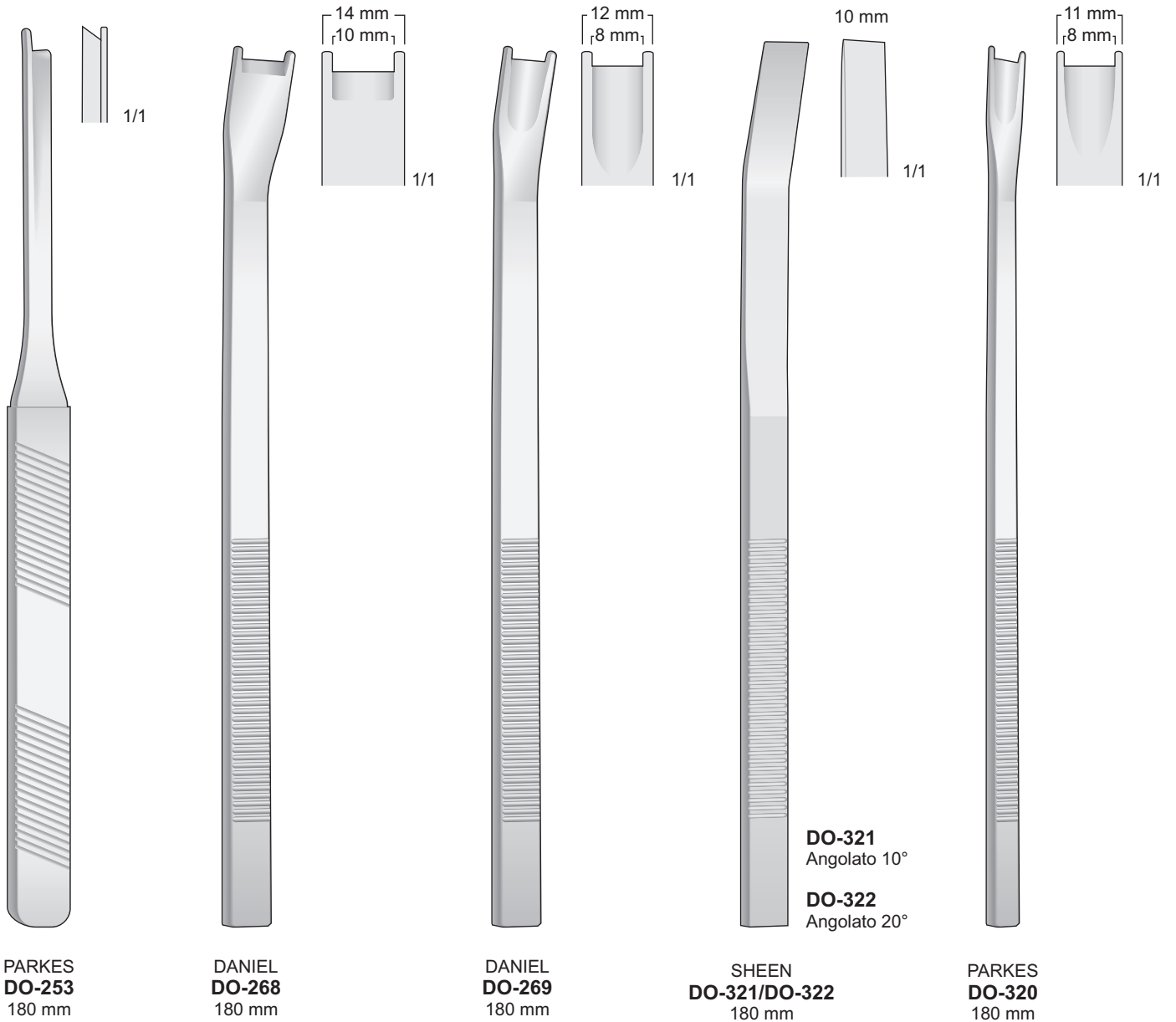

Osteotome mit
Doppelt Protezion

Osteotome with
Double Guarded

Osteotomi con
doppia protezione

Osteotom con
doble protezion

Osteotome avec
double protection

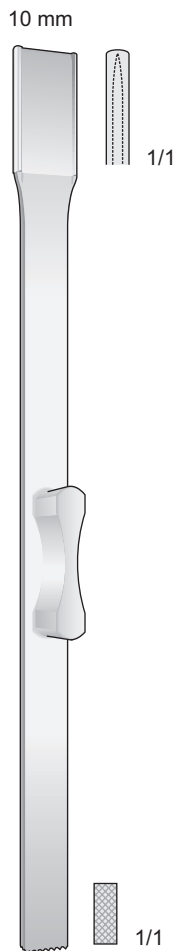

DO-208
160 mm

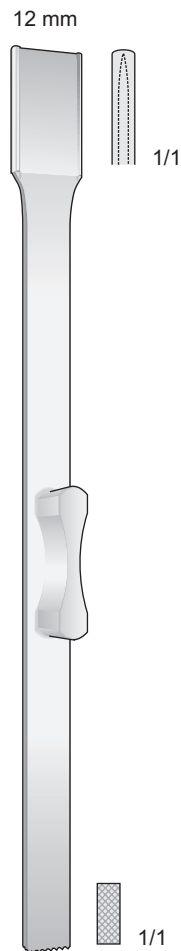

DO-209
160 mm

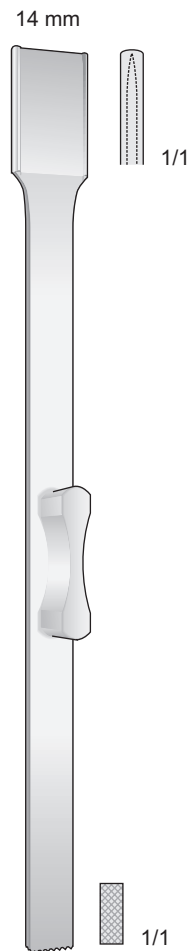

DO-210
160 mm

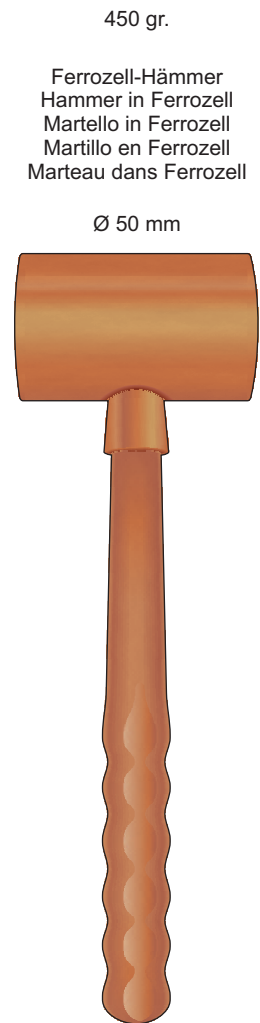

FL-129
260 mm

Knochenfeilen

Bone files

Lime per osso

Limas para huesos

Limes à os



Kopfhautklemme
Scalp Haemostatic
forceps
Pinza emostatica per
il cuoio capelluto
Pinza hemostáticas
para pericraneo

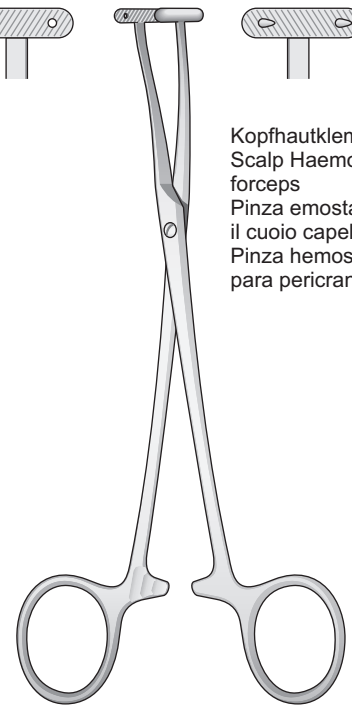

DE MARTEL
FB-119
145 mm

Intranasal Brecher
Intranasal Hammer
Martello intranasale



QUISLING
FL-137
175 mm

Diamantaufage
Diamond Jaw
Punte diamantate

7 mm

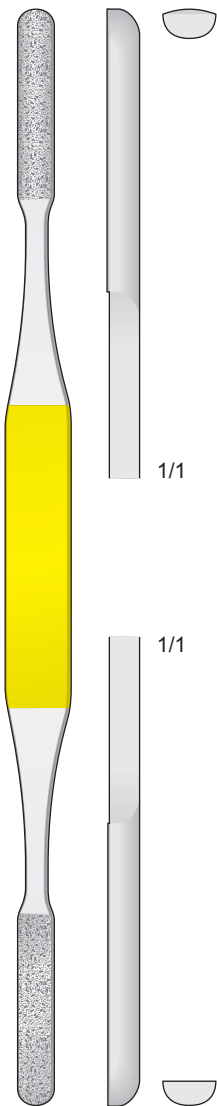

DO-316
215 mm

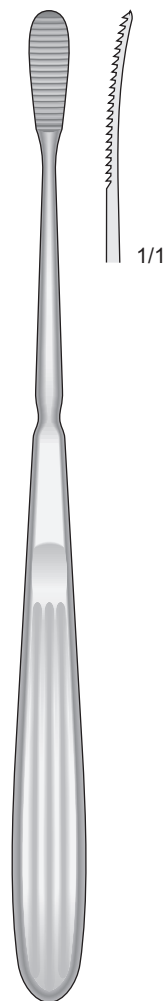

DO-300
190 mm



DO-267
190 mm

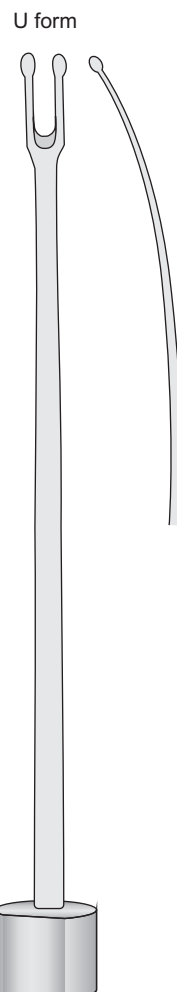

OBWEGESER
DO-110
185 mm

Mikro Pinzetten

Delicate forceps

Micro Pinzette

Pinzas finos

Micro pincas

Mikro Precision Pinzetten

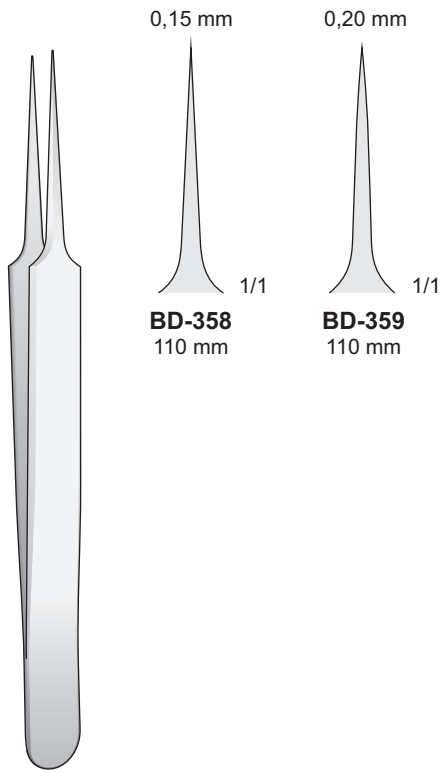

0,15 mm

0,20 mm

BD-358
110 mm

BD-359
110 mm

BD-358/BD-359
110 mm

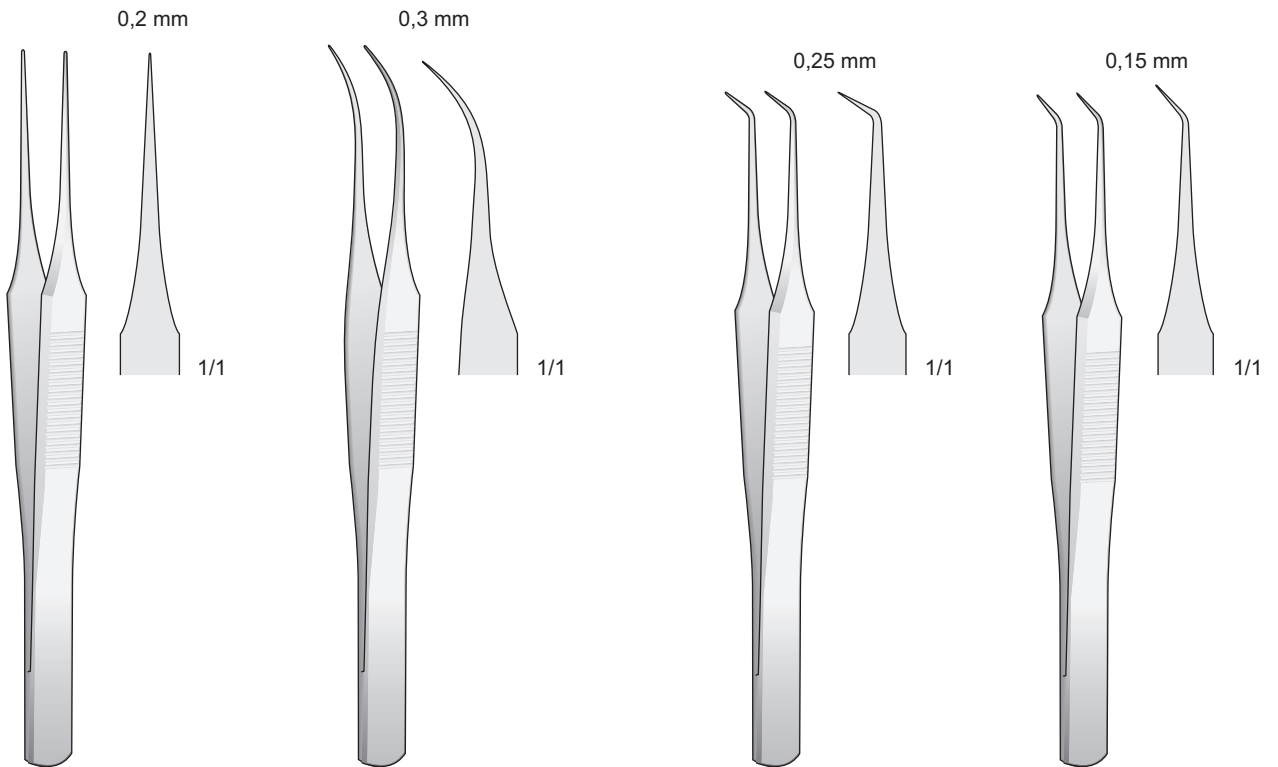

0,2 mm

0,3 mm

0,25 mm

0,15 mm

BD-360
110 mm

BD-361
110 mm

BD-362
100 mm

BD-363
100 mm

Mikro Pinzetten

Delicate forceps

Micro Pinzette

Pinzas finos

Micro pinces

Mikro Precision Pinzetten

Mikro diamantiertes Maul - Micro Diamond Jaw
Micro punta diamantata - Micro boca diamantada
Micro mors diamanté



1/1
1x2 Zähne
1x2 Tooth
1x2 Denti
1x2 Dientes
1x2 Dents



1/1
9x9 Zähne
9x9 Tooth
9x9 Denti
9x9 Dientes
9x9 Dents

CASTROVIEJO
BD-347 0.5 mm
BD-348 0.9 mm
120 mm

BROWN
BD-349
120 mm



0,4 mm
1/1



0,4 mm
1/1



0,4 mm
1/1



0,4 mm
1/1

BD-364
110 mm

BD-365
110 mm

BD-366
130 mm

BD-367
130 mm

Mikro Pinzetten

Delicate forceps

Micro Pinzette

Pinzas finos

Micro pincers

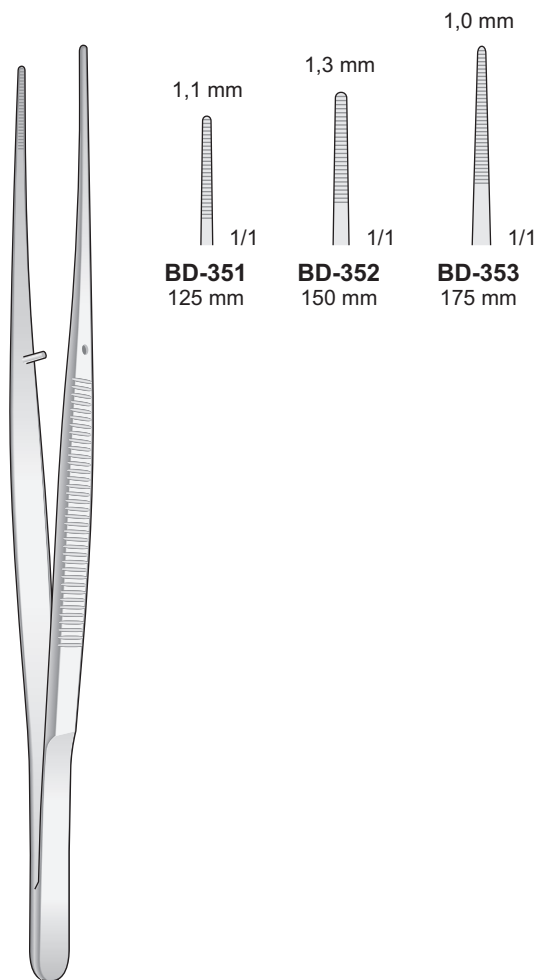

BD-351/BD-353

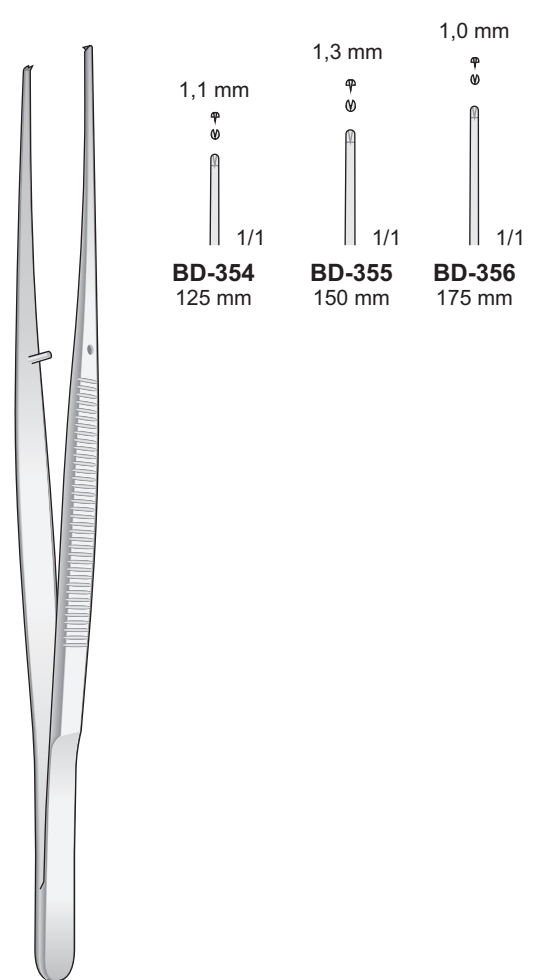

BD-354/BD-355

Chirurgische Pinzetten
Anatomische Pinzetten

Tissue forceps
Dressing forceps

Pinzette chirurgiche
Pinzette anatomiche

Pinzas quirúrgicas
Pinzas de diseccion

Pinces chirurgicales
Pinces anatomiques

Mit Fadenplatte
With tying platform
Con piano prendifilo
Con piattaforma
Avec plateaux pour monofil

1,0 mm

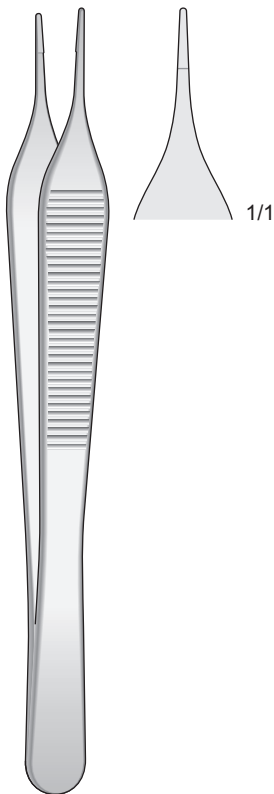

ADSON
BD-370
120 mm

Mit Fadenplatte
With tying platform
Con piano prendifilo
Con piattaforma
Avec plateaux pour monofil

1,0 mm

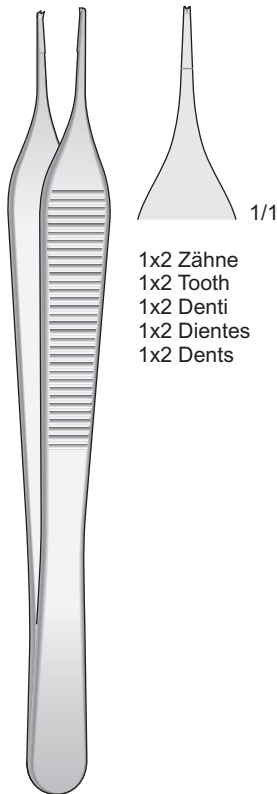

ADSON
BD-371
120 mm

Extra fein
Extra fine
Extra fine

Gebogen
Curved
Curva



MICRO-ADSON
BD-372
120 mm

Extra fein
Extra fine
Extra fine

Gebogen
Curved
Curva

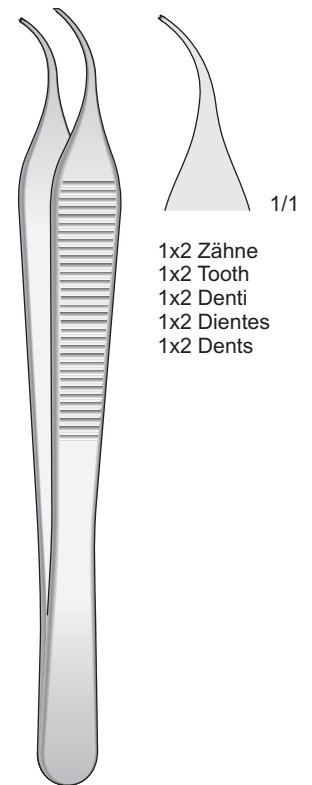

MICRO-ADSON
BD-373
120 mm

1x2 Zähne
1x2 Tooth
1x2 Denti
1x2 Dientes
1x2 Dents

1x2 Zähne
1x2 Tooth
1x2 Denti
1x2 Dientes
1x2 Dents

Chirurgische Pinzetten
Anatomische Pinzetten

Tissue forceps
Dressing forceps

Pinzette chirurgische
Pinzette anatomiche

Pinzas quirúrgicas
Pinzas de diseccion

Pincas quirurgicales
Pincas anatomiques

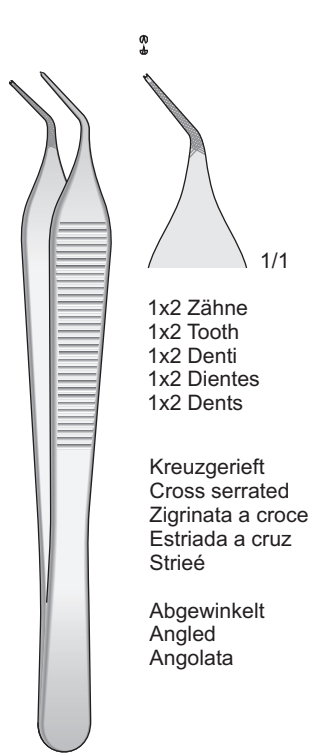

1x2 Zähne
1x2 Tooth
1x2 Denti
1x2 Dientes
1x2 Dents

Kreuzgerieft
Cross serrated
Zigrinata a croce
Estrada a cruz
Striéé

Abgewinkelt
Angled
Angolata

MICRO-ADSON
BD-376
120 mm

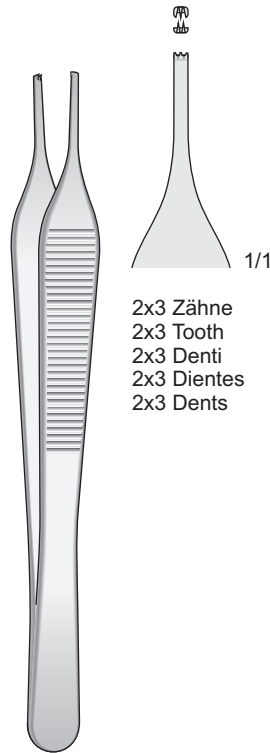

2x3 Zähne
2x3 Tooth
2x3 Denti
2x3 Dientes
2x3 Dents

ADSON
BD-377
120 mm

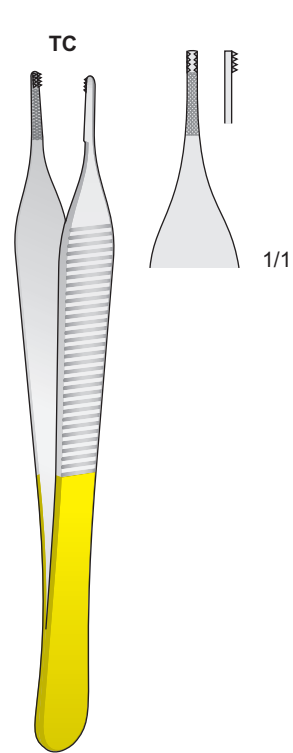

ADSON-BROWN
BD-253
120 mm

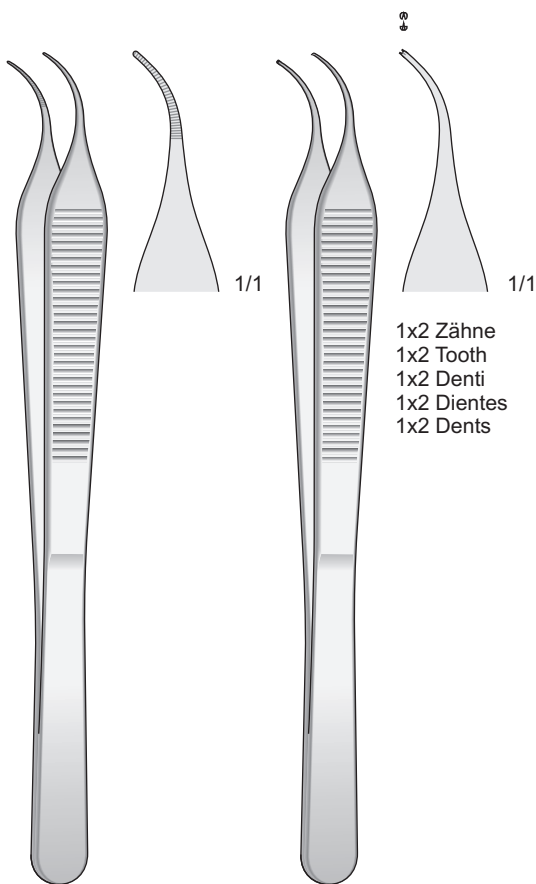

1x2 Zähne
1x2 Tooth
1x2 Denti
1x2 Dientes
1x2 Dents

MICRO-ADSON
BD-374
150 mm

MICRO-ADSON
BD-375
150 mm

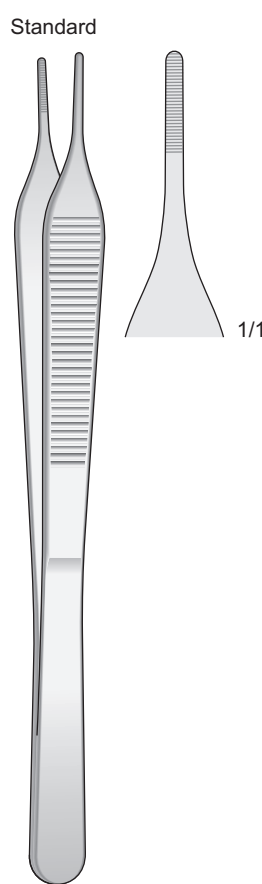

ADSON
BD-380
150 mm

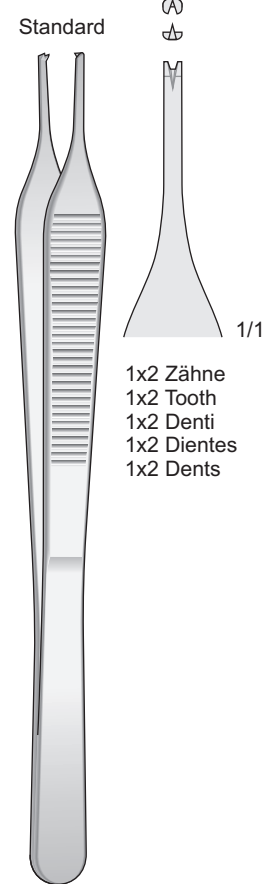

1x2 Zähne
1x2 Tooth
1x2 Denti
1x2 Dientes
1x2 Dents

ADSON
BD-381
150 mm

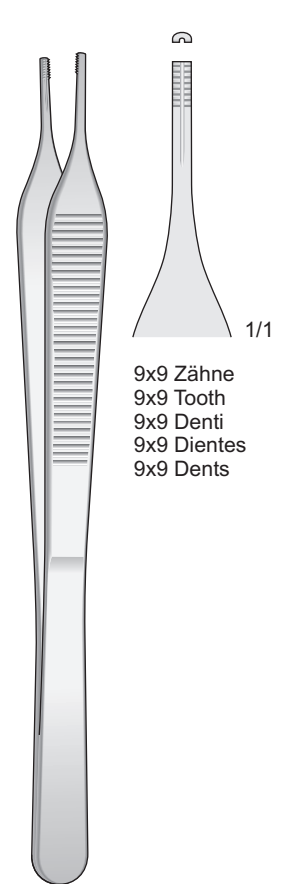

9x9 Zähne
9x9 Tooth
9x9 Denti
9x9 Dientes
9x9 Dents

ADSON-BROWN
BD-382
150 mm

Chirurgische Pinzetten
Anatomische Pinzetten

Tissue forceps
Dressing forceps

Pinzette chirurgiche
Pinzette anatomiche

Pinzas quirùrgicas
Pinzas de diseccion

Pincas quirurgicales
Pincas anatomicas

Pinzette bipolari per coagulazione

Con rivestimento isolante in plastica sterilizzabile

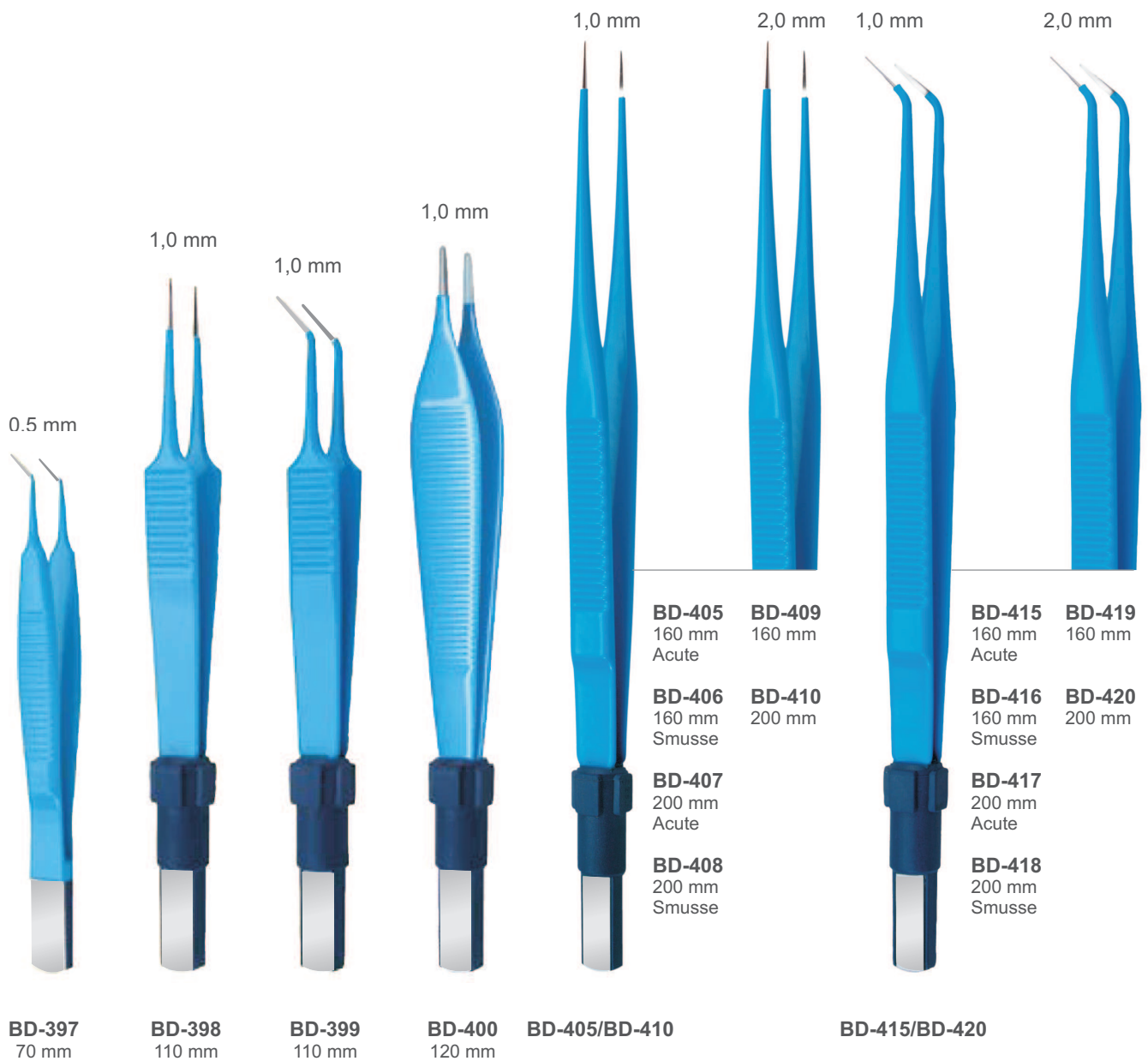

Chirurgische Pinzetten
Anatomische Pinzetten

Tissue forceps
Dressing forceps

Pinzette chirurgiche
Pinzette anatomiche

Pinzas quirúrgicas
Pinzas de disección

Pinces quirúrgicas
Pinces anatómicas

Pinzette bipolari per coagulazione

Con rivestimento isolante in plastica sterilizzabile

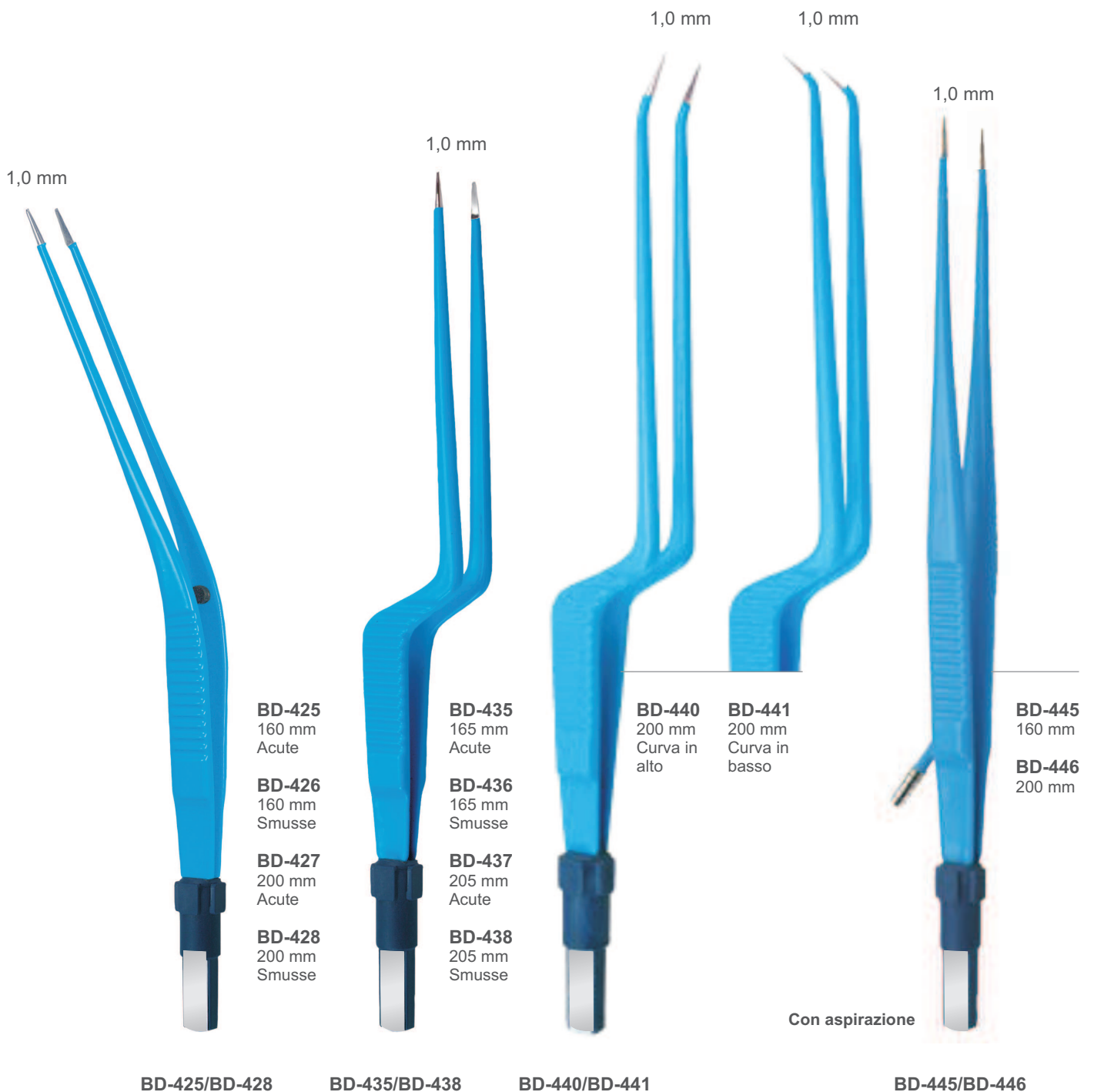

Kanüle
für Liposculture

Cannula
for Liposculture

Cannule da
Liposcultura

Cânulas de
Liposcultura

Canules pour
liposculture

Luer-Lock Cannule

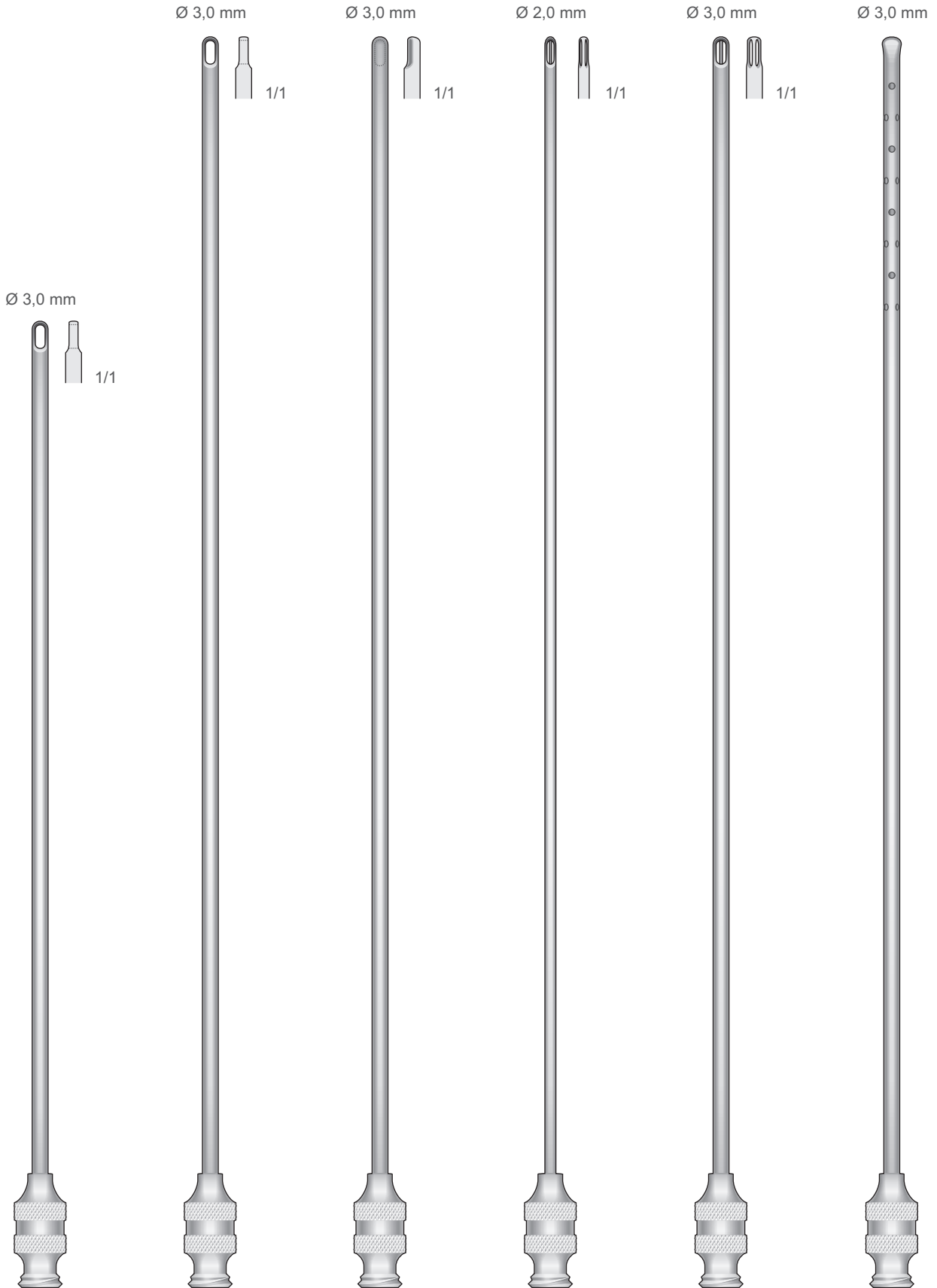

ES-311
150 mm

ES-312
200 mm

ES-313
200 mm

ES-314
200 mm

ES-315
200 mm

ES-316
200 mm

Kanüle
für Liposculture

Cannula
for Liposculture

Cannule da
Liposcultura

Cânulas de
Liposcultura

Canules pour
liposculture

Luer-Lock Cannule

Ø 2,0 mm

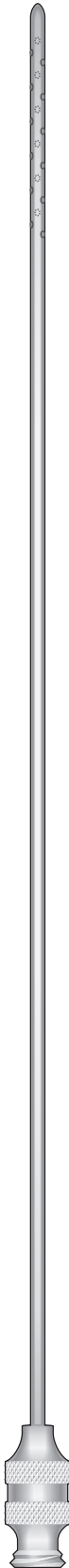

ES-317
200 mm

Ø 3,0 mm



ES-318
200 mm

Ø 3,0 mm



ES-319
300 mm

Ø 2,5 mm

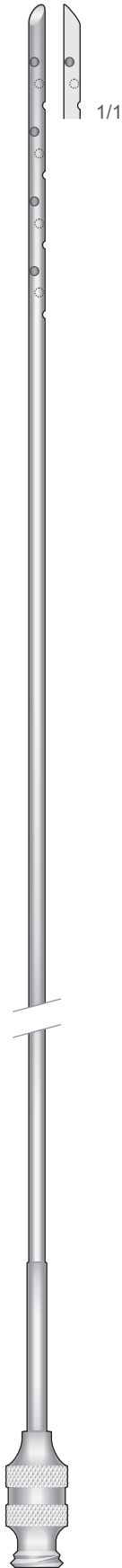

ES-320
250 mm

Ø 3,0 mm

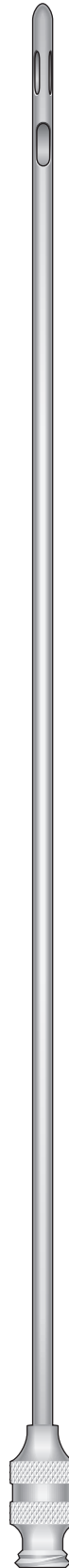

ES-321
200 mm

Ø 3,0 mm



ES-322
300 mm

Ø 3,0 mm



ES-323
250 mm

Infiltration Kanüle

Infiltration Cannula

Cannule da infiltrazione

Cànulas de infiltración

Canules pour infiltration

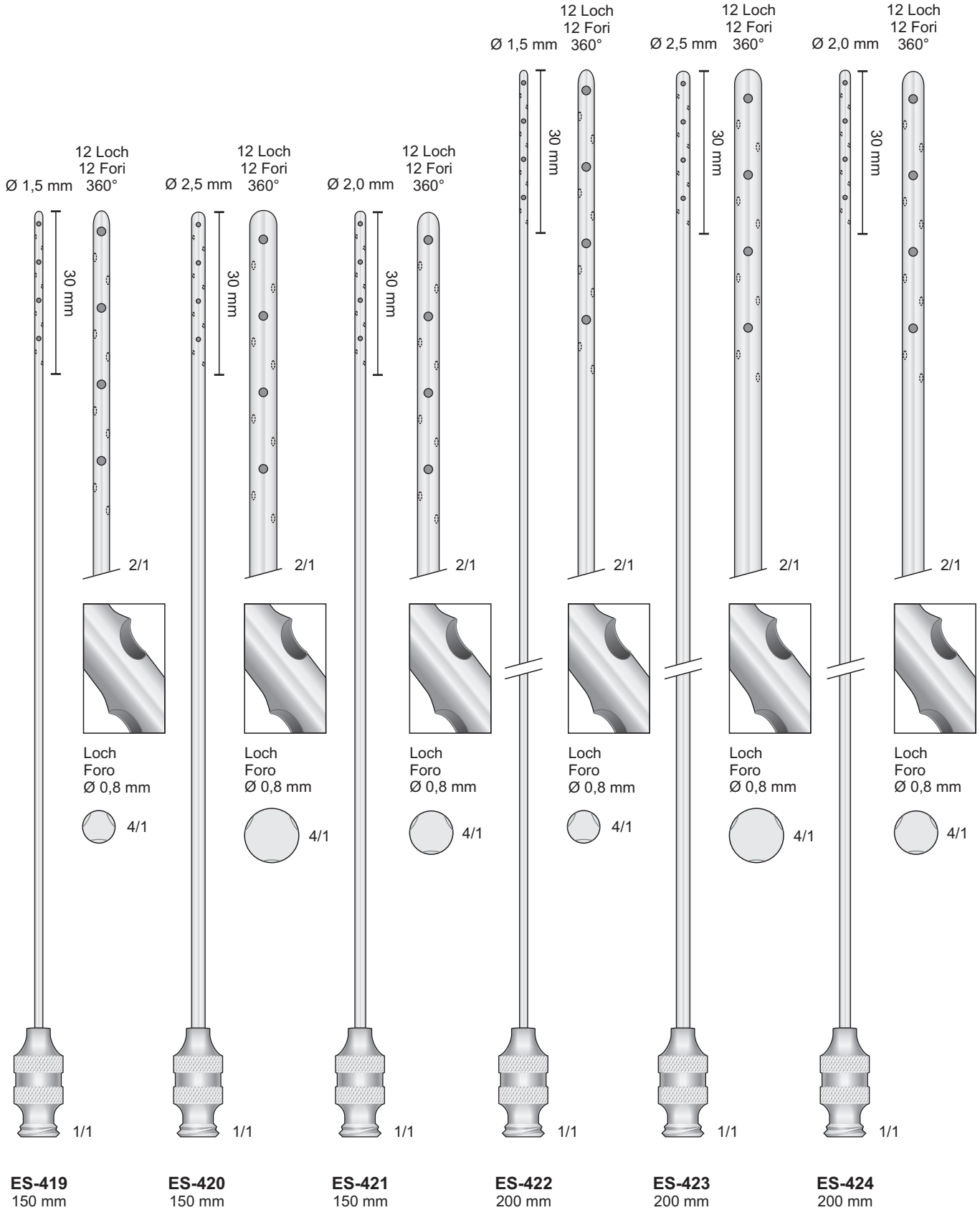

**Makro
Absaugkanülen**

**Macro
Suctions Tubes**

**Macro cannule
per aspirazione**

**Macro Cànulas
aspiradoras**

**Macro Canules
aspiratrices**

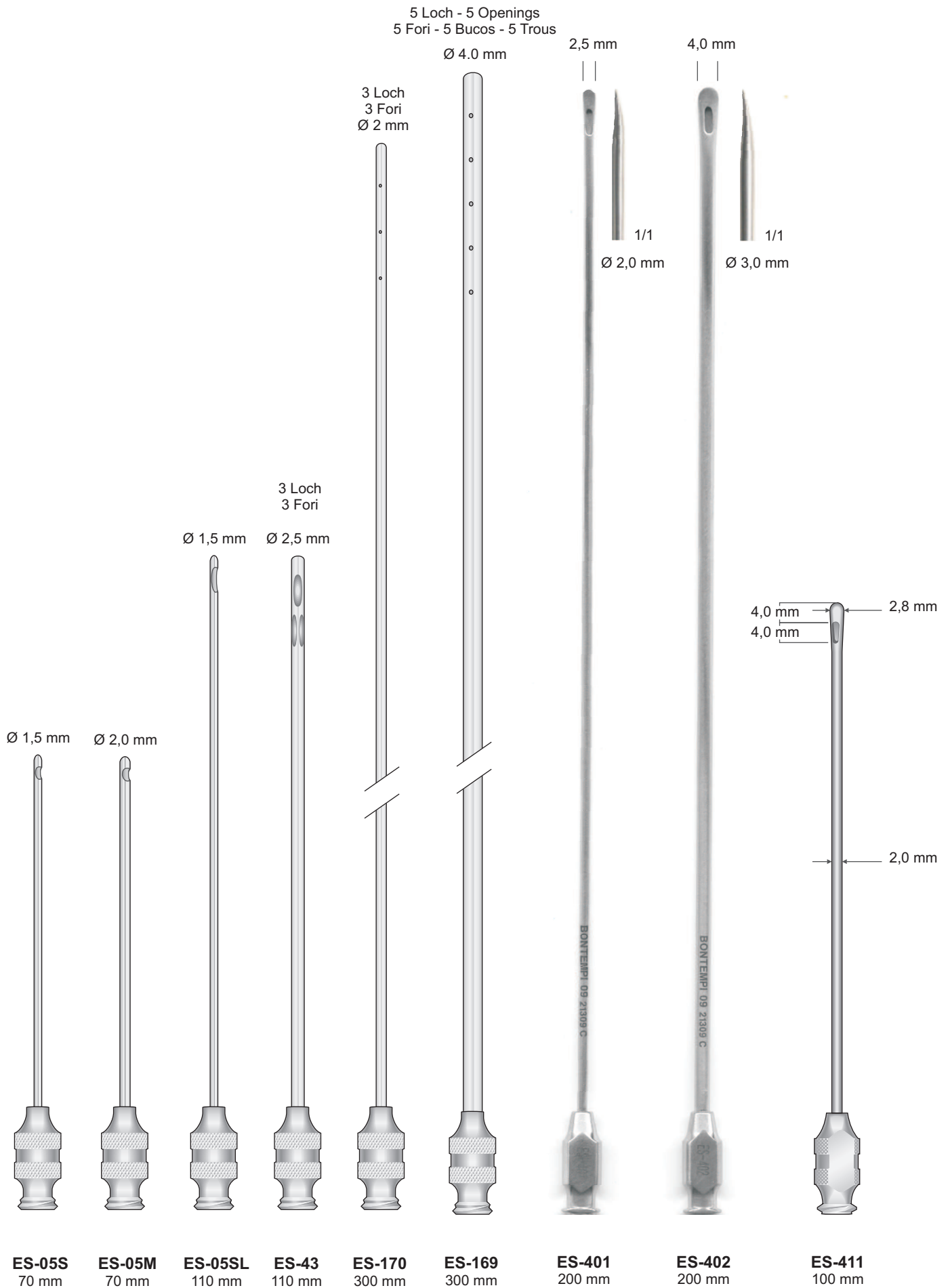

Griff Rostfrei Stainless Steel Handles Manici in acciaio Inox Mangos de acero inoxidable Manche en acier inoxydable

Rostfreies Verbindungsteil zum Kanüle-Nadel
Connection piece for cannula-needles
Raccordo inox per cannula-ago
Juntura inox para jeringa-agujas
Adapter en acier pour canule-aiguilles

Universal Adapter for Syringe

Aluminium Blau
Aluminium Blue
Alluminio Blu
Aluminio Azul
Aluminium Bleu



ES-02

Griff Rostfrei
Stainless Steel Handle
Manico in acciaio Inox
Mango de acero inoxidable
Manche en acier inoxydable

Ø 15 mm



ES-29
195 mm

130 mm



Luer Lock

SD-50
50 ml

Raccordo per
due siringhe



Luer Lock

Luer Lock

1/1

ES-03
21 mm



ES-301
160 mm



ES-04



ES-302
155 mm

Raccordo
Luer Lock



1/1

ES-306
34 mm

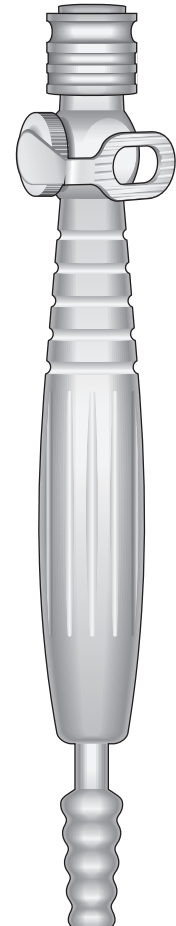

ES-303
155 mm

Infiltration Kanüle

Infiltration Cannula

Cannule da infiltrazione

Càndulas de infiltración

Canules pour infiltration

Ø 2,0 mm

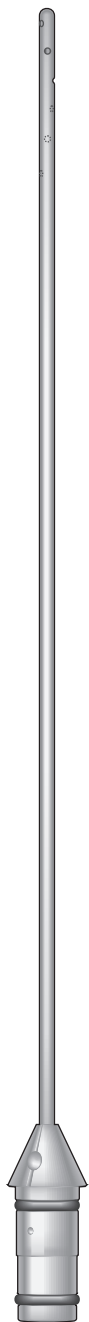

ES-331
150 mm

Ø 3,0 mm

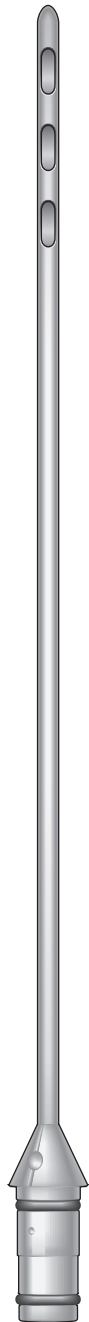

ES-339
150 mm

Ø 4,0 mm

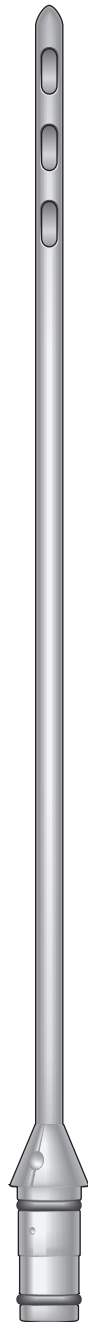

ES-340
150 mm

Ø 3,0 mm



ES-341
250 mm

Ø 4,0 mm

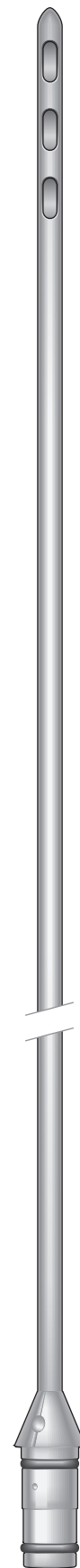

ES-342
250 mm

Ø 4,0 mm

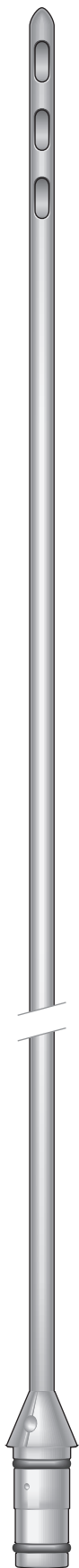

ES-343
300 mm

Infiltration Kanüle

Infiltration Cannula

Cannule da infiltrazione

Cànullas de infiltración

Canules pour infiltration

ES-346	Ø 2,0 mm	150 mm
ES-347	Ø 3,0 mm	150 mm
ES-348	Ø 4,0 mm	150 mm
ES-349	Ø 5,0 mm	150 mm
ES-350	Ø 2,0 mm	250 mm
ES-351	Ø 3,0 mm	250 mm
ES-352	Ø 4,0 mm	250 mm
ES-353	Ø 5,0 mm	250 mm
ES-354	Ø 6,0 mm	250 mm
ES-355	Ø 3,0 mm	300 mm
ES-356	Ø 4,0 mm	300 mm
ES-357	Ø 5,0 mm	300 mm
ES-358	Ø 6,0 mm	300 mm
ES-359	Ø 3,0 mm	150 mm
ES-360	Ø 3,0 mm	250 mm
ES-361	Ø 4,0 mm	150 mm
ES-362	Ø 4,0 mm	250 mm
ES-363	Ø 4,0 mm	300 mm

ES-344
150 mm

ES-345
200 mm

MERCEDES
ES-346/ES-358

LAS VEGAS
ES-359/ES-363

**Makro
Absaugkanülen**

**Macro
Suctions Tubes**

**Macro cannule
per aspirazione**

**Macro Cánulas
aspiradoras**

**Macro Canules
aspiratrices**

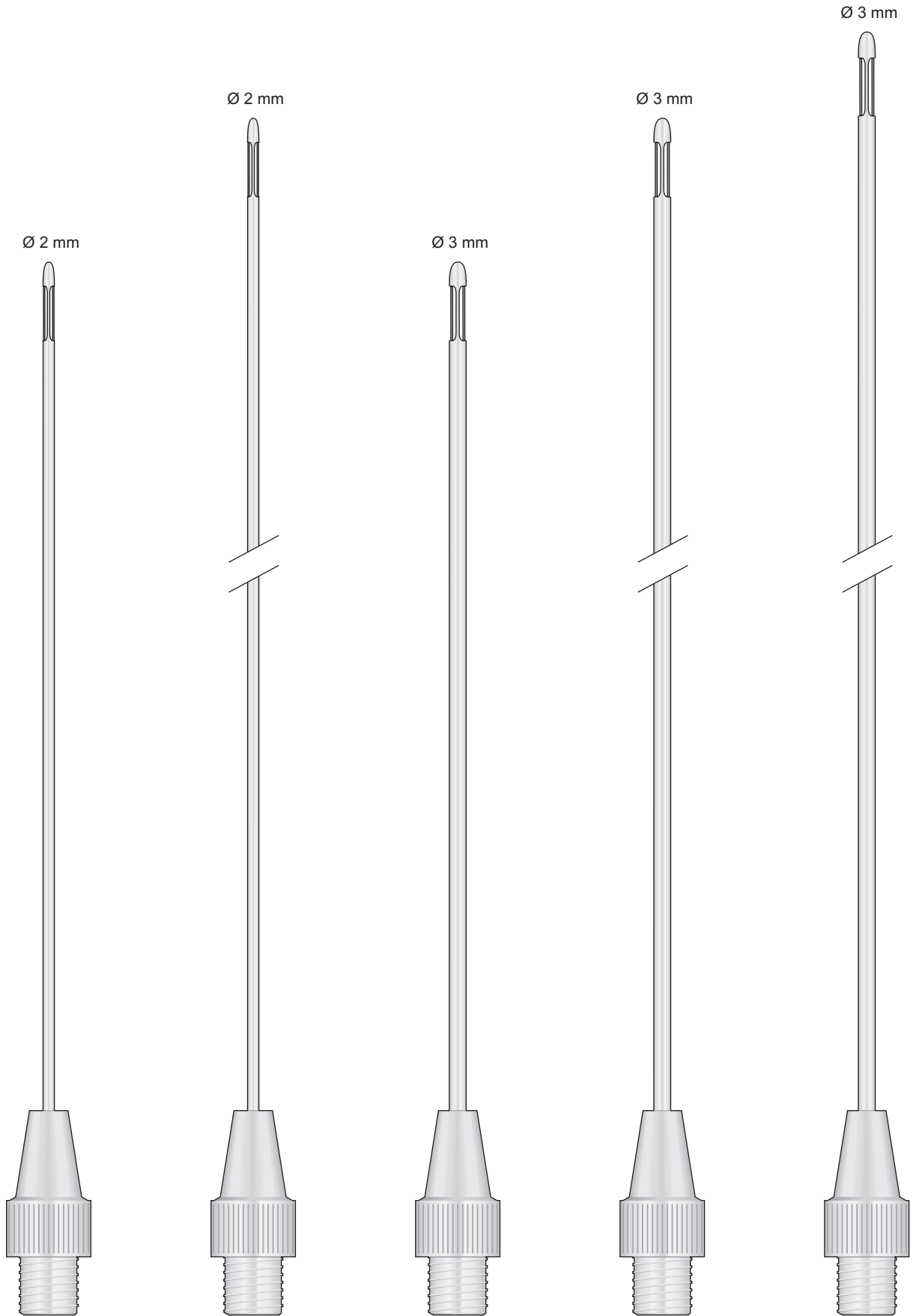

MERCEDES
ES-180
150 mm

MERCEDES
ES-181
250 mm

MERCEDES
ES-182
150 mm

MERCEDES
ES-183
250 mm

MERCEDES
ES-184
300 mm

**Makro
Absaugkanülen**

**Macro
Suctions Tubes**

**Macro cannule
per aspirazione**

**Macro Cánulas
aspiradoras**

**Macro Canules
aspiratrices**

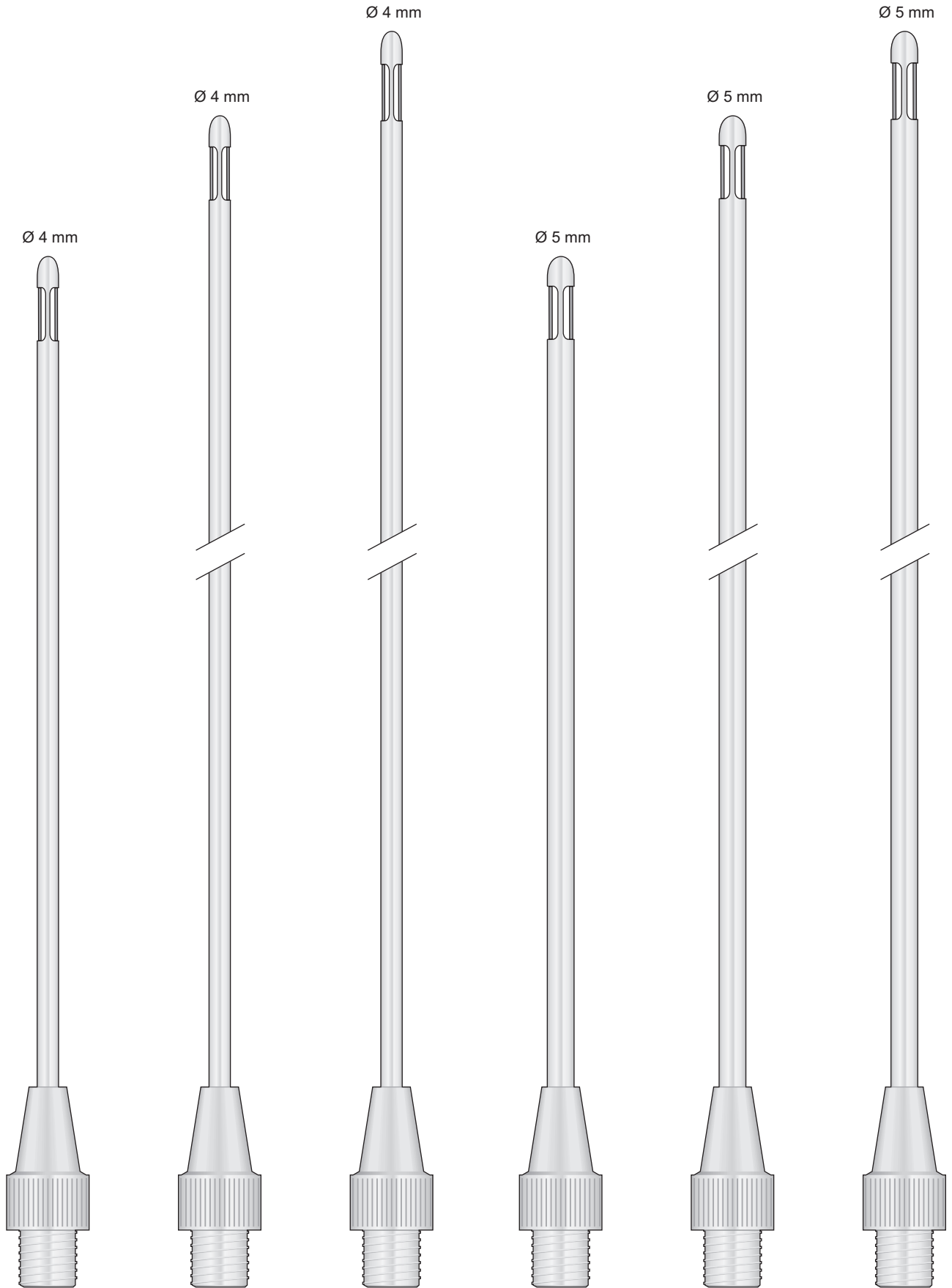

MERCEDES
ES-185
150 mm

MERCEDES
ES-186
250 mm

MERCEDES
ES-187
300 mm

MERCEDES
ES-188
150 mm

MERCEDES
ES-189
250 mm

MERCEDES
ES-190
300 mm

**Makro
Absaugkanülen**

**Macro
Suctions Tubes**

**Macro cannule
per aspirazione**

**Macro Cánulas
aspiradoras**

**Macro Canules
aspiratrices**

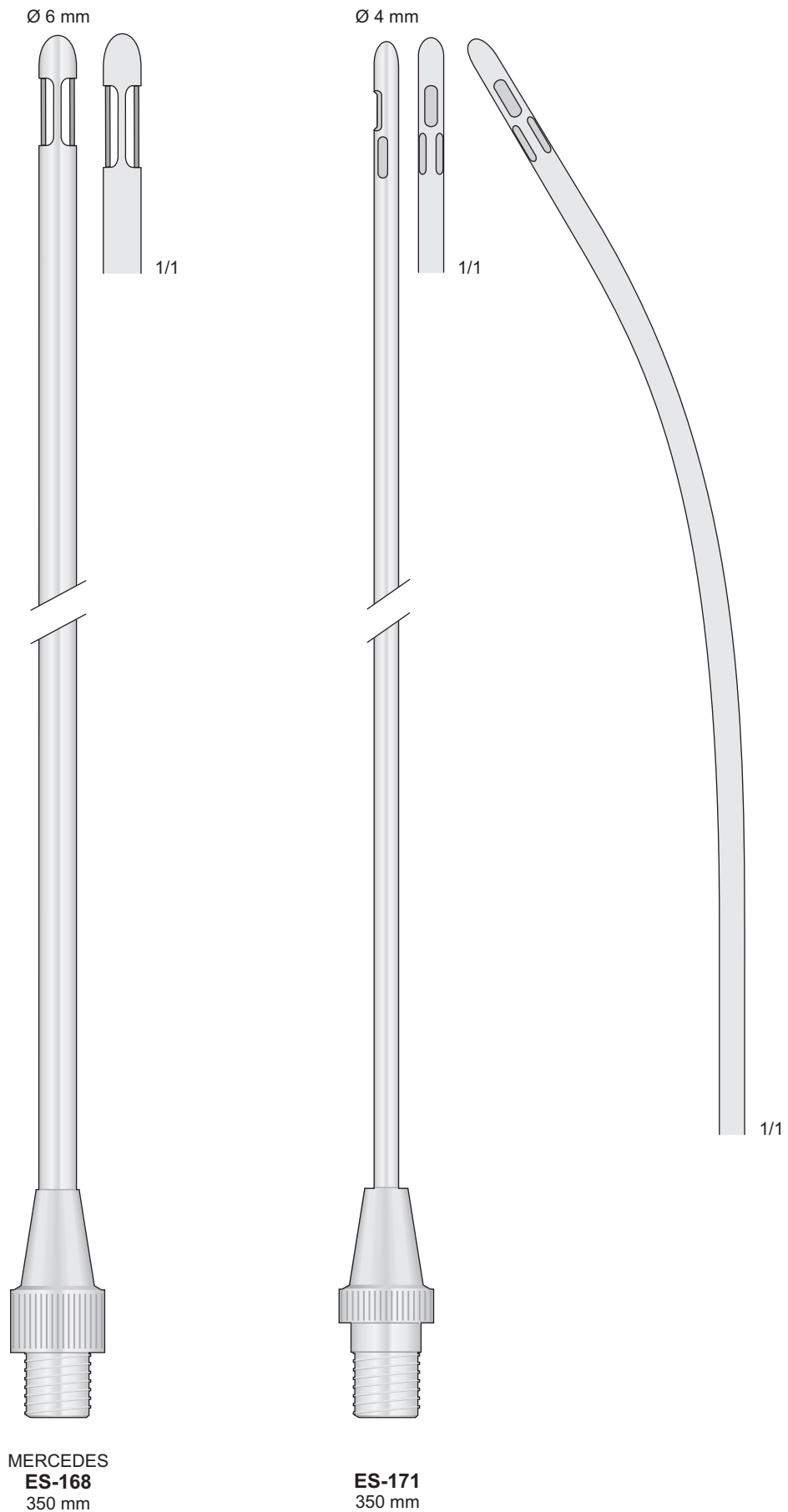

**Makro
Absaugkanülen**

**Macro
Suctions Tubes**

**Macro cannule
per aspirazione**

**Macro Cànulas
aspiradoras**

**Macro Canules
aspiratrices**

Absaugkanülen für Fettleibige - Needles and Tubes for obese patients
Aghi da infiltrazione per grandi obesi - Cànulas aspiradoras para obeso
Canules aspiratrices pour obèse

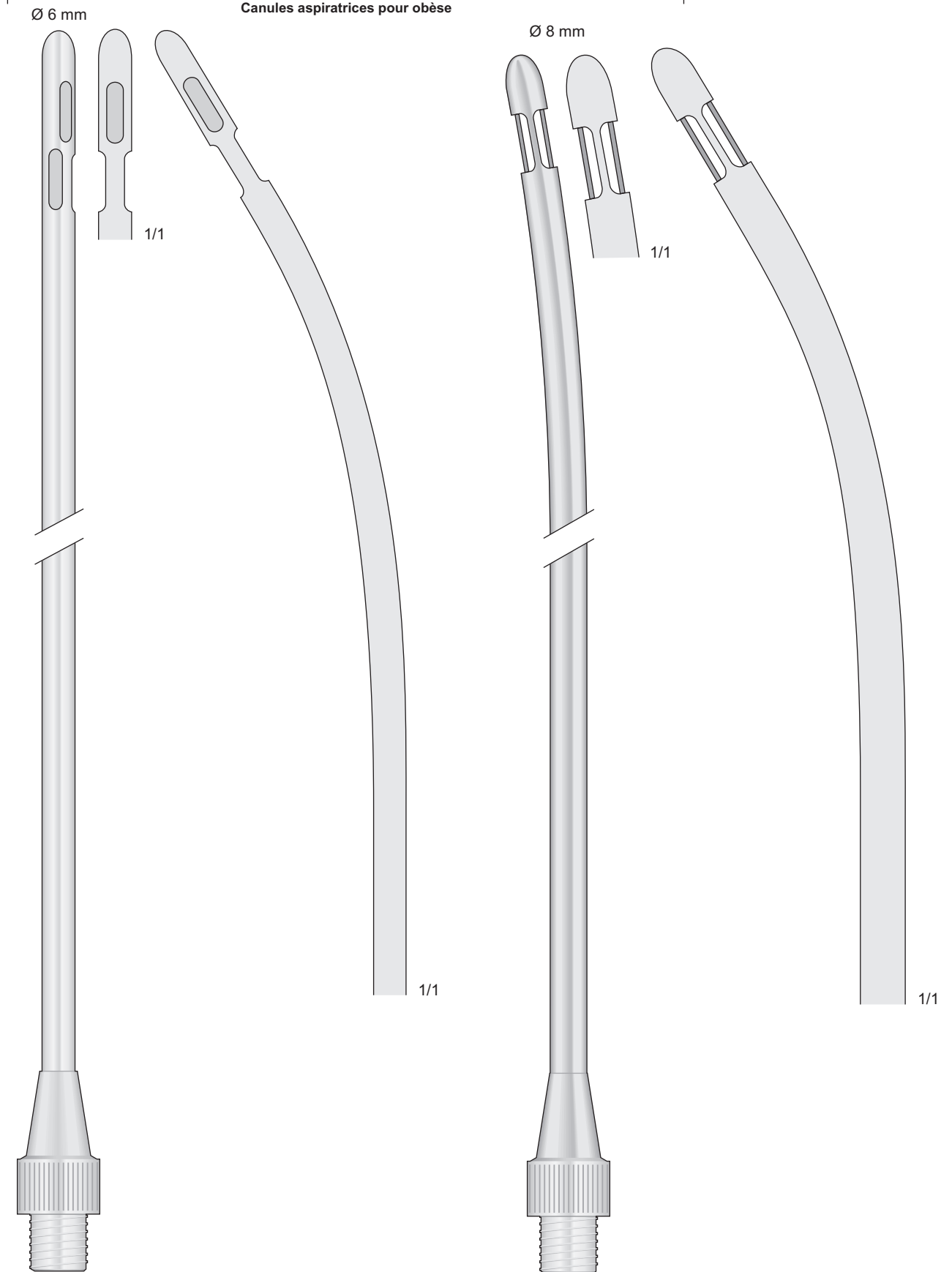

ES-172
350 mm

**MERCEDES
ES-173**
350 mm

Infiltration Kanüle

Infiltration Cannula

Cannule da infiltrazione

Cánulas de infiltración

Canules pour infiltration

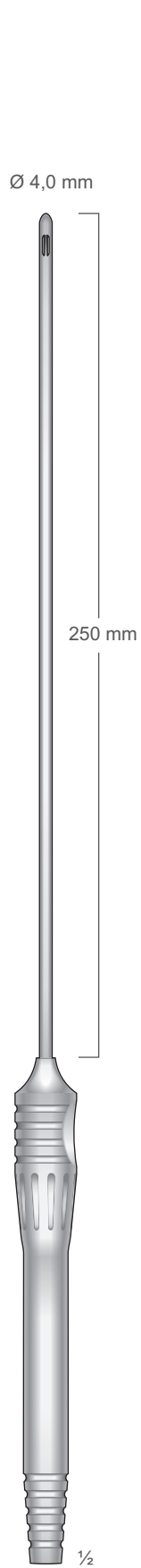

MERCEDES
ES-372
400 mm

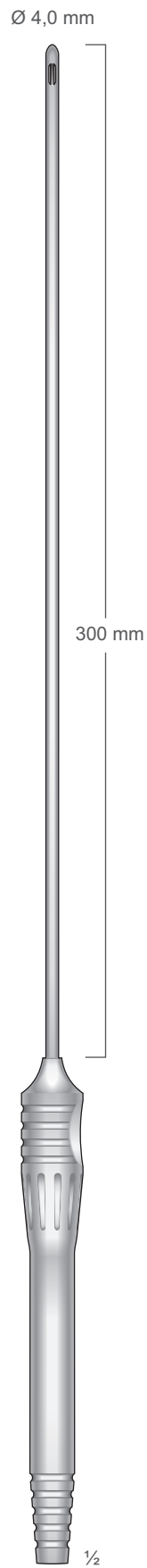

MERCEDES
ES-373
450 mm

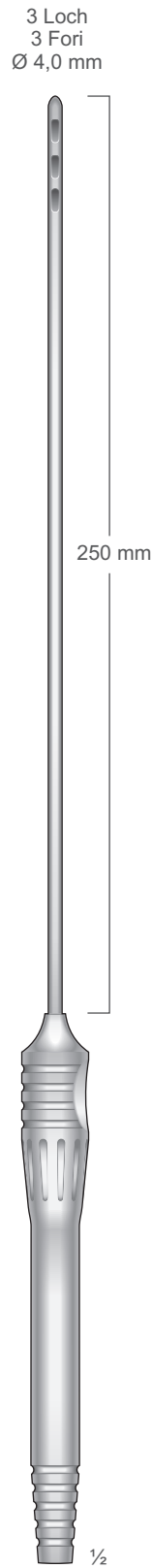

ES-374
400 mm

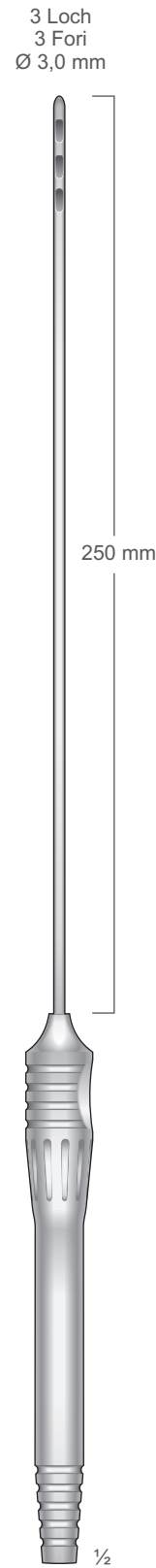

ES-374S
400 mm

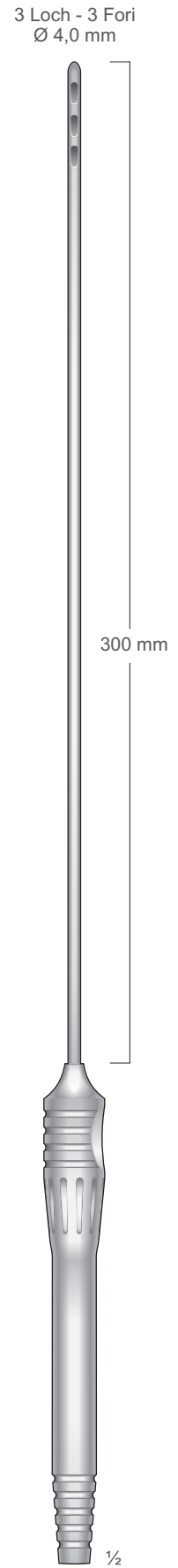

ES-375
450 mm

Kanülenreinigungs
bürsten

Cleaning brush
for tubes

Scovolini per
pulizia cannule

Cepillo para
limpiar cánulas

Brosse de nettoyage
pour canules

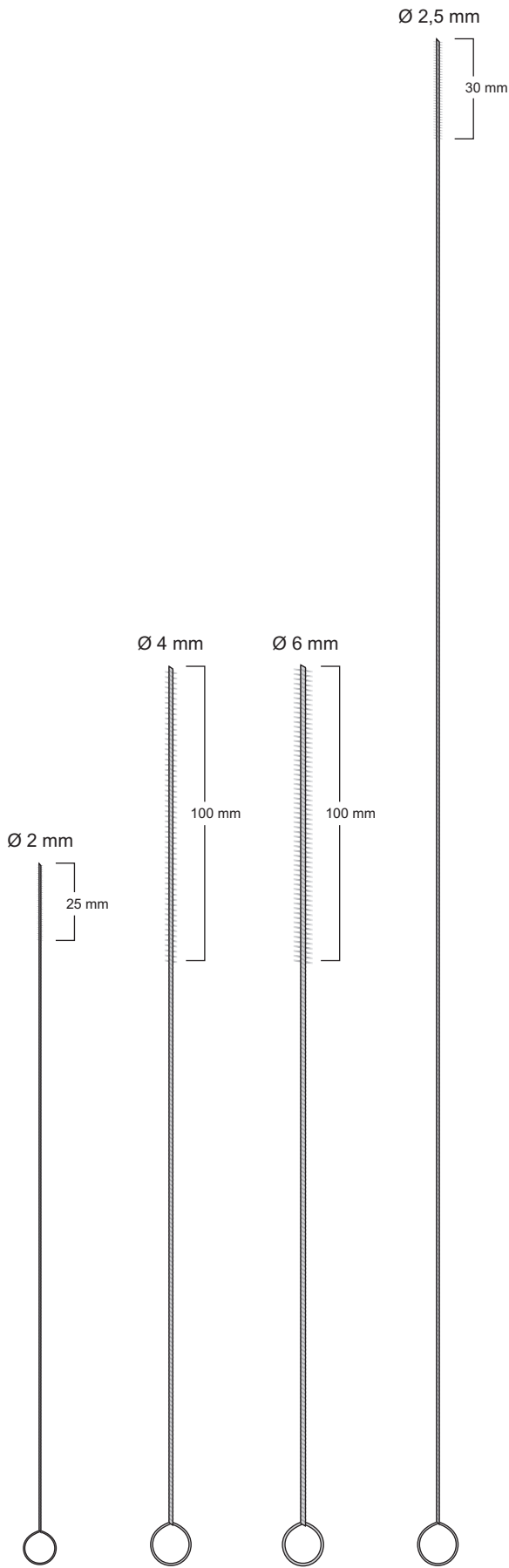

GF-182
215 mm

GF-183
300 mm

GF-185
300 mm

GF-186
500 mm

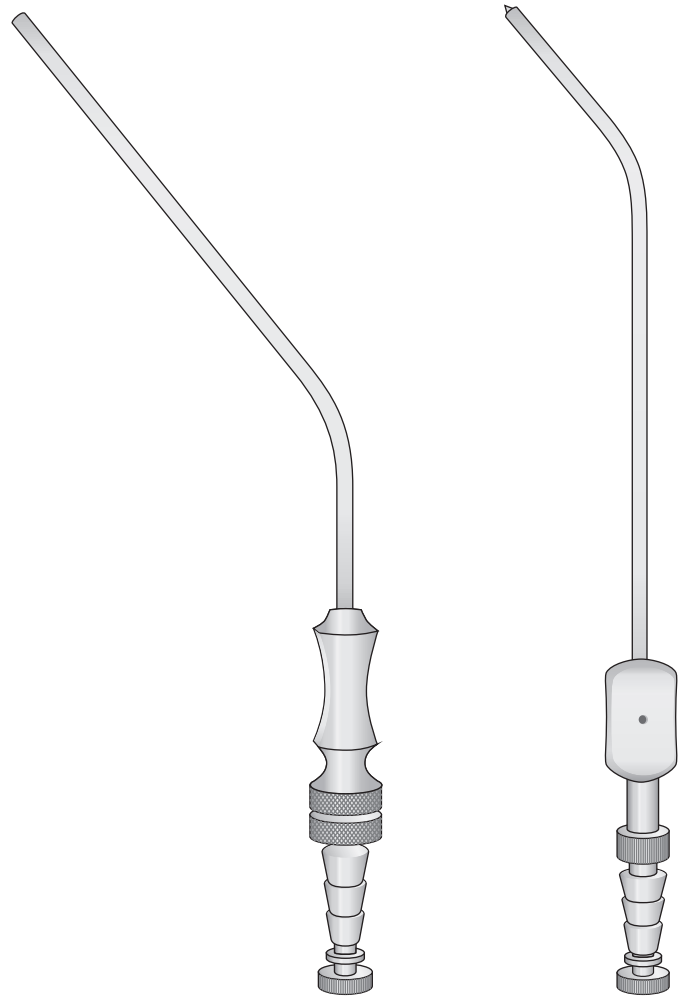

FRAZIER
GF-241B Ch. 8 2,7 mm
GF-242B Ch. 10 3,3 mm
180 mm

PLESTER
GF-151B Ch. 8 2,7 mm
GF-152B Ch. 10 3,3 mm
200 mm

Various Instruments

Strumenti vari

Instrumentos varios

new

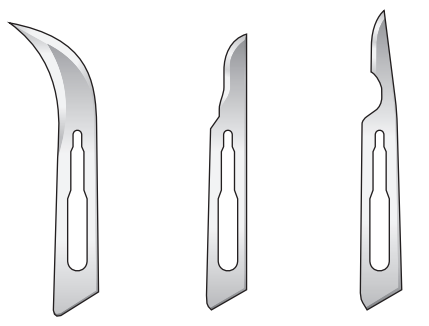

LB-12D LB-15A LB-15C

Pinza per unghie
Nail nipper
Nagelspaltzange
Pince à ongles
Pinzas corta uñas

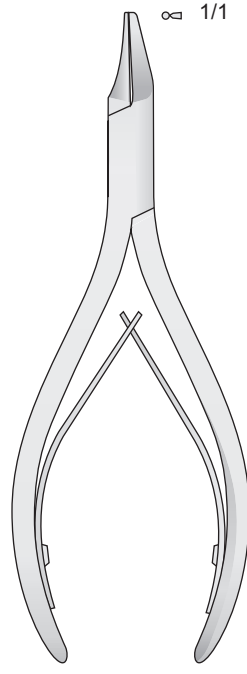

DP-09
135 mm

2,5 x 1,4 mm 0,2 x 4,0 mm



DP-109
130 mm

Raspatorien, Dissektoren
Raspatories, Dissector
Raschiatori, Dissettori
Separadores
Rugines

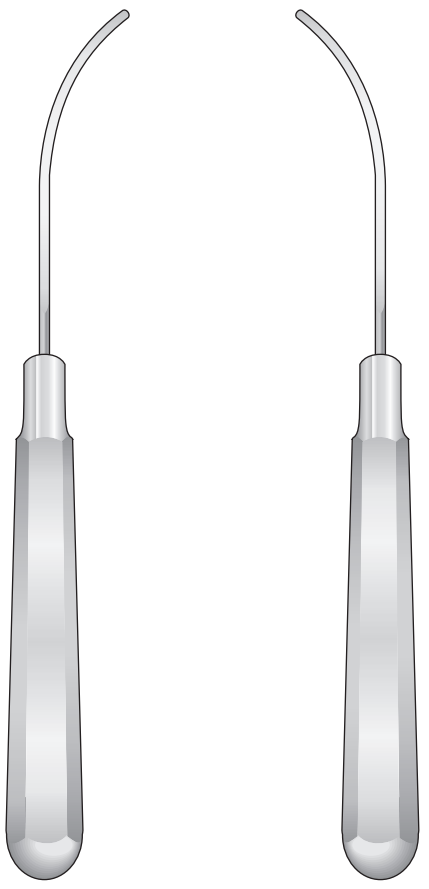

DINGMANN
DO-265
155 mm
1-L

DINGMANN
DO-266
155 mm
2-R

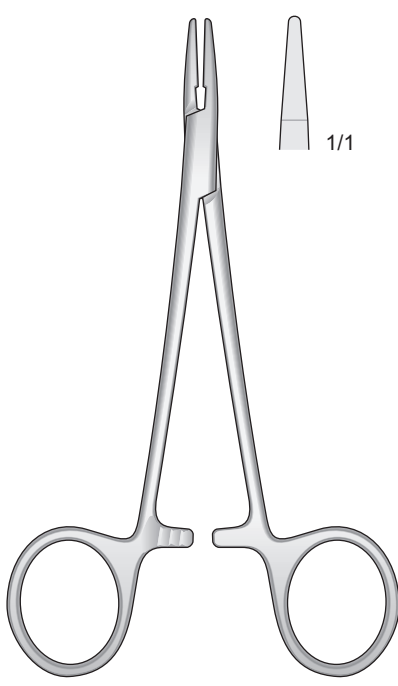

HALSEY
PH-37
130 mm

Pinza per rimozione
punti metallici

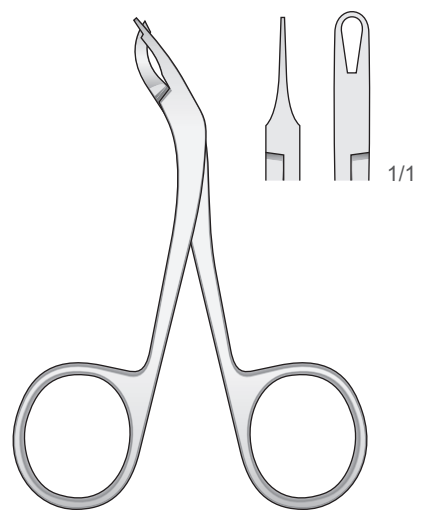

BF-64
115 mm

Dermatome

Dermatomes

Dermatomi

Dermàtomos

Dermatomes

Dermatome komplett mit 1 auswechselbarer Klinge und 2 Spannplatten
 Dermatome complete with 1 interchangeable blade and 2 skin plates
 Dermatomo a mano, con una lama intercambiabile, completo di 2 placche per stendere la pelle
 Dermatomo completo, con 1 hoja intercambiabile y 2 placas para extender la piel
 Dermatome avec 1 lame interchangeable et 2 plaques pour tendre la peau

Einstellbar von 0,1 bis 3,0 mm
 Adjustable from 0,1 to 3,0 mm
 Regolazione da 0,1 a 3,0 mm
 Regulable de 0,1 hasta 3,0 mm
 Réglable en épaisseur de 0,1 à 3,0 mm

Einstellbar von 0,1 bis 4,0 mm
 Adjustable from 0,1 to 4,0 mm
 Regolazione da 0,1 a 4,0 mm
 Regulable de 0,1 hasta 4,0 mm
 Réglable en épaisseur de 0,1 à 4,0 mm

Für handelsübliche Rasierklingen
 For usual razor blades
 Per lamette standard
 Para hojas de afeitar usuales
 Pour lames de rasoir modèle standard

Spanplatte
 Skin Fixing Plate
 Placca per stendere la pelle
 Placa para extender la piel
 Plaque pour tendre la peau



**SCHINK
DE-10**



**SILVER
DE-11
190 mm**

Ersatzklinge, allein
 Spare Blade only
 Lama di ricambio sola
 Hoja de repuesto
 Lame de rechange, seule



**SILVER
DE-12
43 mm**

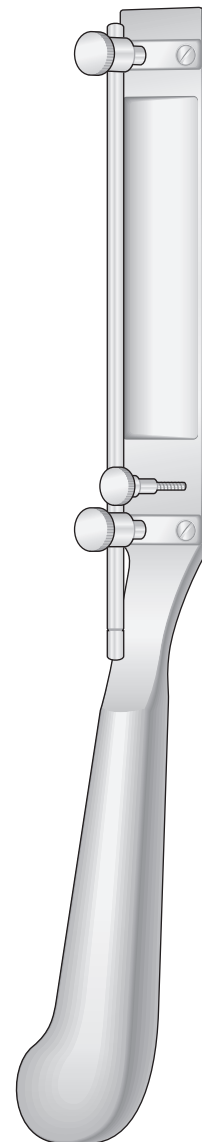

**SCHINK
DE-13
300 mm**

Ersatzklinge, allein
 Spare Blade only
 Lama di ricambio sola
 Hoja de repuesto
 Lame de rechange, seule



**SCHINK
DE-14
102 mm**

Dermatome

Dermatomes

Dermatomi

Dermátomos

Dermatomes

Dermatome komplett mit 1 auswechselbarer Klinge und 2 Spannplatten
 Dermatome complete with 1 interchangeable blade and 2 skin plates

Dermatomo a mano, con una lama intercambiabile, completo di 2 placche per stendere la pelle
 Dermatomo completo, con 1 hoja intercambiable y 2 placas para extender la piel
 Dermatome avec 1 lame interchangeable et 2 plaques pour tendre la peau

Einstellbar von 0,1 bis 1,5 mm
 Adjustable from 0,1 to 1,5 mm
 Regolazione da 0,1 a 1,5 mm
 Regulable de 0,1 hasta 1,5 mm
 Réglable en épaisseur de 0,1 à 1,5 mm

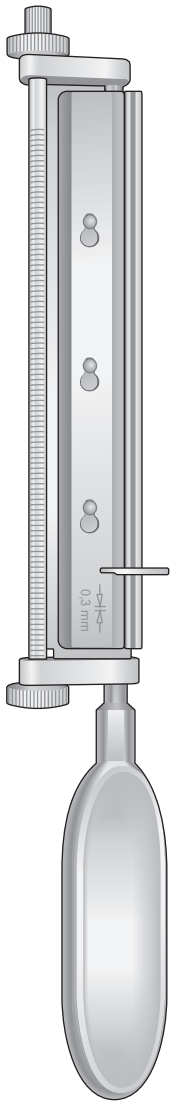

**WATSON
DE-15**
300 mm



**COBBETT
DE-16**
300 mm

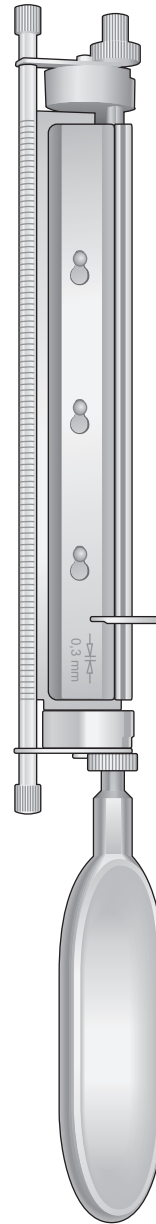

**HUMBY
DE-17**
320 mm

Ersatzklinge, allein
 Spare Blade only
 Lama di ricambio sola
 Hoja de repuesto
 Lame de rechange, seule



**HUMBY
DE-18**
157 mm

Haken Stripper

Vein Stripper

Uncini per vene

Sonda para varices

Stripper a anneau

ES-150
Komplettset mit 3 Stück - Set complete with 3 pieces
Set completo con 3 pezzi - Set completo con 3 piezas
Set complete avec 3 pièces

ES-151 + ES-152 + ES-153

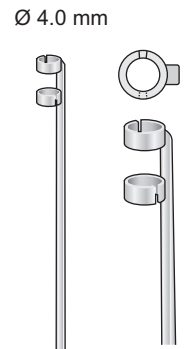

ES-151
120 mm



ES-152
125 mm



ES-153
130 mm



ES-154
135 mm



**FISCHER
FO-235**
310 mm

Original Arkansas



DB-96
ARKANSAS n°8
100 x 50 x 13 mm

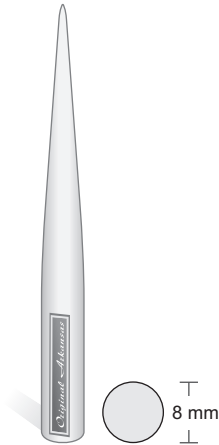

DB-299
ARKANSAS
conica n° 299
90 mm

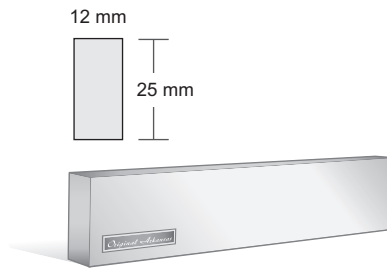

DB-4
ARKANSAS n°4
100 mm

Special Gummi für Metal
Special Rubber for Metal
Gomme speciali per metalli

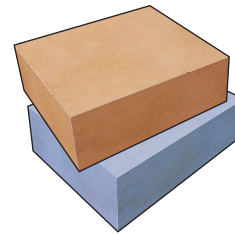

DB-07
50 x 40 x 20 mm
Fein - Fine
Grana Fine
Finas - Fin

DB-08
50 x 40 x 20 mm
Größ - Large
Grana grossa
Grande - Large

Instrumente-Reinigungsbürste
Brush for instruments
Spazzolino per pulizia strumenti
Cepillo para instrumentos
Brosse pour instruments



SCHARPENOIL
DB-OL
30 cc

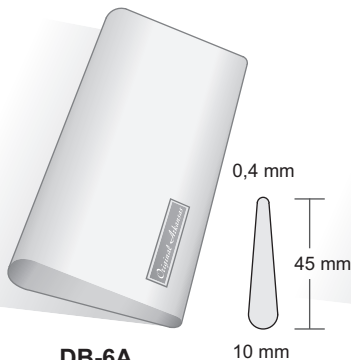

DB-6A
ARKANSAS n°6A
100 mm

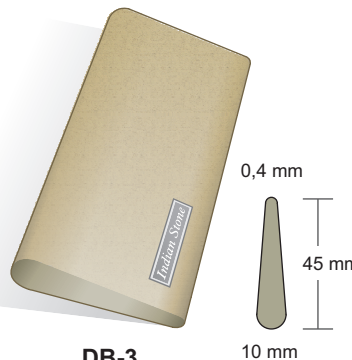

DB-3
INDIA n°6
100 mm

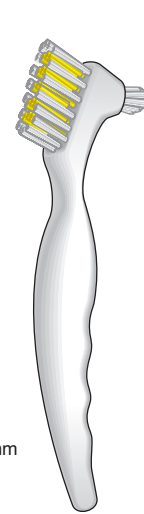

DB-11
155 mm

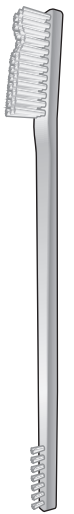

DB-12
175 mm

**Steril
Container**

**Sterilizing
containers**

**Contenitori per
sterilizzare**

**Contenedores
para esterilización**

**Containers
pour stérilizer**

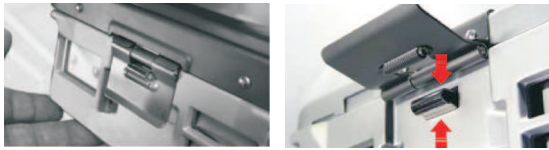

Kleinsetcontainer / Mini Container

Außen / outside / esterno
exterior / extérieur
300 x 140 x 40 mm

Innen / inside / interno
interior / intérieur
280 x 130 x 27 mm

- CT-555N
- CT-556N
- CT-557N
- CT-558N
- CT-559N

Kleinsetcontainer / Mini Container

Außen / outside / esterno
exterior / extérieur
300 x 140 x 70 mm

Innen / inside / interno
interior / intérieur
280 x 130 x 55 mm

- CT-560N
- CT-561N
- CT-562N
- CT-563N
- CT-564N

Kleinsetcontainer / Mini Container

Außen / outside / esterno
exterior / extérieur
300 x 140 x 100 mm

Innen / inside / interno
interior / intérieur
280 x 130 x 84 mm

- CT-565N
- CT-566N
- CT-567N
- CT-568N
- CT-569N

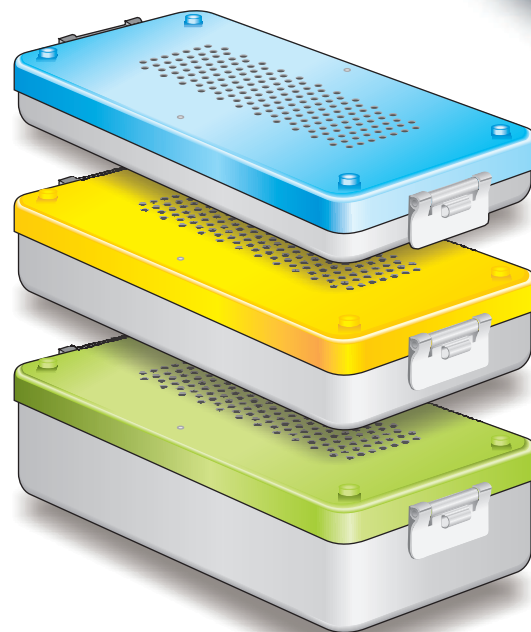

TS-103

260 x 120 mm - 6 mm

Silikon Noppenmatten
Silicon Mats
Tappeti in aghi di silicone
Tapete en agujas de silicona
Tapis de silicone

Sterilisierbar
Autoclavable
Autoclavabili
Esterilizable
Stérilisable

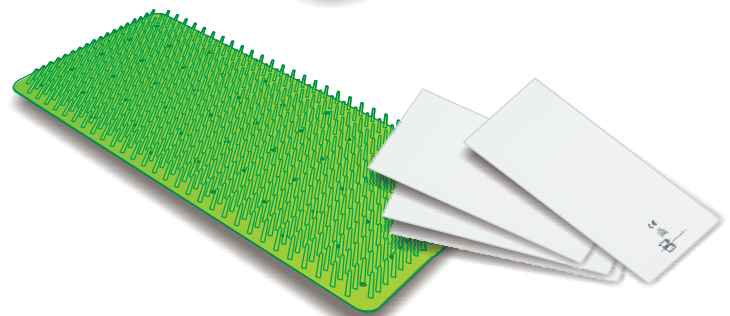

CT-660

94 x 215 mm - Box 1 pc.

Teflon Filter für 1200 Zyklen
Teflon Filter for 1200 cycles
Filtro in teflon per 1200 cicli
Filtro de teflón para 1200 ciclos
Filtre de téflon pour 1200 cycles

CT-670

Box 100 pc.

Kunststoff-Dichtungen
Plastic seals
Sigilli di plastica
Sellos de plástico
Scellés en plastique

CT-672

Box 100 pc.

Label Einweg
Disposable-Label
Etichetta monouso
Etiqueta desechables
Étiquettes jetables

CT-702

65 x 65 mm

Baumwolle Handtuch Verpackung
Cotton Towel Packaging
Telo in cotone per confezionamento
Embalaje de toallas de algodón
Emballage de serviettes de coton



Indice alfanumerico		Alfanumerical Index		Nummernverzeichnis		Index alphabétique		Indice alfanumerico	
Articolo	Pagina	Articolo	Pagina	Articolo	Pagina	Articolo	Pagina	Articolo	Pagina
BD-253	39	BT-362	27	DO-219	29				
BD-347	36	BT-363	27	DO-228	29				
BD-348	36	BT-364	27	DO-229	29				
BD-349	36	BT-365	27	DO-238	29				
BD-350	28	BT-370	27	DO-239	29				
BD-351	37	BT-501	8	DO-253	32				
BD-352	37	BT-502	8	DO-254	31				
BD-353	37	BT-503	8	DO-255	31				
BD-354	37	BT-504	8	DO-256	31				
BD-355	37	BT-505	9	DO-265	56				
BD-356	37	BT-506	9	DO-266	56				
BD-358	35	BT-507	8	DO-267	34				
BD-359	35	BT-510	9	DO-268	32				
BD-360	35	BT-511	11	DO-269	32				
BD-361	35			DO-275	31				
BD-362	35	CT-555	61	DO-276	31				
BD-363	35	CT-556	61	DO-277	31				
BD-364	36	CT-557	61	DO-278	31				
BD-365	36	CT-558	61	DO-297	31				
BD-366	36	CT-559	61	DO-298	31				
BD-367	36	CT-560	61	DO-300	34				
BD-370	38	CT-561	61	DO-316	34				
BD-371	38	CT-562	61	DO-320	32				
BD-372	38	CT-563	61	DO-321	32				
BD-373	38	CT-564	61	DO-322	32				
BD-374	39	CT-565	61	DO-401	19				
BD-375	39	CT-566	61	DO-401R	19				
BD-376	39	CT-567	61						
BD-377	39	CT-568	61	DP-109	56				
BD-380	39	CT-569	61						
BD-381	39	CT-660	61	ES-02	46				
BD-382	39	CT-670	61	ES-03	46				
BD-397	40	CT-672	61	ES-04	46				
BD-398	40	CT-702	61	ES-05M	45				
BD-399	40			ES-05S	45				
BD-400	40	DB-07	60	ES-05SL	45				
BD-405	40	DB-08	60	ES-18S	13				
BD-406	40	DB-3	60	ES-19S	13				
BD-407	40	DB-4	60	ES-20S	13				
BD-408	40	DB-6A	60	ES-20	13				
BD-409	40	DB-11	60	ES-29	46				
BD-410	40	DB-12	60	ES-43	45				
BD-415	40	DB-15	60	ES-86	50				
BD-416	40	DB-96	60	ES-87	50				
BD-417	40	DB-101Z	25	ES-110	28				
BD-418	40	DB-118	25	ES-130	19				
BD-419	40	DB-119	25	ES-131	14				
BD-420	40	DB-299	60	ES-132	14				
BD-425	41	DB-OL	60	ES-133	14				
BD-426	41			ES-134	14				
BD-427	41	DE-10	57	ES-135	14				
BD-428	41	DE-11	57	ES-136	14				
BD-435	41	DE-12	57	ES-137	14				
BD-436	41	DE-13	57	ES-138	14				
BD-437	41	DE-14	57	ES-139	14				
BD-438	41	DE-15	58	ES-144	16				
BD-440	41	DE-16	58	ES-145	11				
BD-441	41	DE-17	58	ES-145M	11				
BD-445	41	DE-18	58	ES-146	12				
BD-446	41			ES-147	12				
		DO-110	34	ES-148	12				
BF-64	56	DO-113	30	ES-149	16				
		DO-114	30	ES-150	51				
BT-21	28	DO-115	30	ES-151	59				
BT-53	27	DO-116	30	ES-152	59				
BT-58	27	DO-135	30	ES-153	59				
BT-59	27	DO-207	16	ES-154	59				
BT-138	28	DO-208	33	ES-163	16				
BT-149	27	DO-209	33	ES-164	13				
BT-150	27	DO-210	33	ES-165	13				



Indice alfanumerico		Alfanumerical Index		Nummernverzeichnis		Index alphabétique		Indice alfanumerico	
Articolo	Pagina	Articolo	Pagina	Articolo	Pagina	Articolo	Pagina	Articolo	Pagina
ES-168	52	ES-363	48	GF-183	55				
ES-169	45	ES-372	54	GF-185	55				
ES-170	45	ES-373	54	GF-186	55				
ES-171	52	ES-374	54	GF-241B	55				
ES-172	53	ES-374S	54	GF-242B	55				
ES-173	53	ES-375	54			HT-131K	10		
ES-179	50	ES-401	45			HT-134K	10		
ES-180	49	ES-402	45			HT-180X	10		
ES-181	49	ES-411	45			HT-250S	10		
ES-182	49	ES-419	44			HT-LED	10		
ES-183	49	ES-420	44						
ES-184	49	ES-421	44			LB-12D	56		
ES-185	51	ES-422	44			LB-15A	56		
ES-186	51	ES-423	44			LB-15C	56		
ES-187	51	ES-424	44						
ES-188	51	ES-450	44			NK-400	18		
ES-189	51								
ES-190	51	FB-119	44			OM-09	28		
ES-191	50					OM-106	24		
ES-192	50	FG-121	7			OM-107	24		
ES-211	15	FG-163	4			OM-108	24		
ES-212	15	FG-192	6			OM-108M	24		
ES-213	15	FG-193	6			OM-109	24		
ES-215	15	FG-194	6			OM-190	20		
ES-216	15	FG-195	6			OM-191	20		
ES-217	15					OM-192	20		
ES-219	16	FL-19	29			OM-192L	20		
ES-221	28	FL-129	33			OM-193	21		
ES-301	46	FL-137	34			OM-194	21		
ES-302	46	FL-413	29			OM-195	21		
ES-303	46	FL-414	29			OM-195L	21		
ES-306	46	FL-415	29			OM-196	22		
ES-311	42	FL-416	29			OM-197	22		
ES-312	42					OM-198	22		
ES-313	42	FM-100L	3			OM-230	17		
ES-314	42	FM-300T	3			OM-231	17		
ES-315	42	FM-301T	3			OM-240	23		
ES-316	42	FM-302	4			OM-241	23		
ES-317	43	FM-304	4			OM-242	23		
ES-318	43	FM-308	4			OM-243	23		
ES-319	43	FM-313	3						
ES-320	43	FM-313G	5			PH-37	56		
ES-321	43	FM-314G	5						
ES-322	43	FM-318	4			RE-01	8, 19		
ES-323	43	FM-319	4			RE-02	8, 19		
ES-331	47	FM-332	4			RE-03	8, 19		
ES-339	47	FM-332G	5			RE-10	8, 19		
ES-340	47	FM-333	4						
ES-341	47	FM-333G	5			SC-3	7		
ES-342	47	FM-400	18						
ES-343	47	FM-401	18			SD-50	46		
ES-344	48								
ES-345	48	FO-95	7			TS-103	61		
ES-346	48	FO-190	7						
ES-347	48	FO-235	44						
ES-348	48	FO-350	25						
ES-349	48	FO-370	26						
ES-350	48	FO-371	26						
ES-351	48	FO-372	26						
ES-352	48	FO-390	26						
ES-353	48	FO-391	26						
ES-354	48	FO-392	26						
ES-355	48	FO-397	26						
ES-356	48								
ES-357	48	FR-34	29						
ES-358	48	FR-190	28						
ES-359	48								
ES-360	48	GF-151B	55						
ES-361	48	GF-152B	55						
ES-362	48	GF-182	55						



Bontempi

SURGICAL INSTRUMENTS
PORTUGAL

Passion for Excellence

Rua Poeta de Bocage, nº 15-F, Letra J
1600-240 Lisboa
T: + 351 210 968 925
F: + 351 210 968 925

info@bontempiportugal.pt
www.bontempiportugal.pt