



Bontempi

SURGICAL INSTRUMENTS
PORTUGAL

Passion for Excellence



Katalog der Kieferorthopädie
Catalogue of Orthodontics
Catalogo di Ortodonzia
Catálogo de Ortodoncia
Catalogue de l'Orthodontie

Drahtschneidezange
Wire Cutting Pliers
Tronchesi
Alicate para cortar
Pince coupante



BONTEMPI
CHIRURGISCHE INSTRUMENTE

Passion for excellence

Schneidezangen
Ligaturen-Cutter

Cutters
Ligature Cutters

Tronchesi
Tronchesi per legature

Alicates de corte
Alicates para cortar ligaduras

Pincès coupantes
Pincès coupe-ligatures

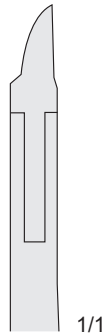

1/1

○ Max Ø 0.3 mm (.012")

Ligaturen Schneidezange
Ligature Cutters
Solo per rimuovere le legature
Alicates para cortar ligaduras
Pince à sectionner les ligatures

Für weichen und harten Draht
For soft and hard Wire
Per fili sottili e morbidi
Para alambre blando y duro
Pour fil léger e dur

ANGLE
LX-95
130 mm

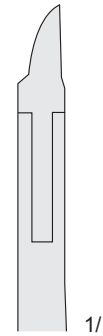

1/1



Mit Hartmetalleinsätzen
With Hard Metal Inserts
Con punte in metallo duro
Con puntas de metal duro
Avec mors en métal dur

○ Max Ø 0.4 mm (.016")

Ligaturen Schneidezange
Ligature Cutters
Solo per rimuovere le legature
Alicates para cortar ligaduras
Pince à sectionner les ligatures

Für weichen und harten Draht
For soft and hard Wire
Per fili sottili e morbidi
Para alambre blando y duro
Pour fil léger e dur

ANGLE
LX-95TC
130 mm

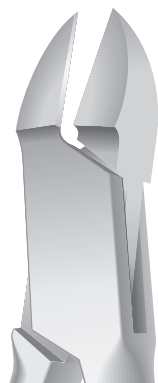

1/1

○ Max Ø 1.0 mm (.040")

Seitenschneider
Side Cutters
Taglio laterale
De corte lateral
Coupante latérale

Für harten Draht
For hard Wire
Per fili grossi e duri
Para alambre duro
Pour fil dur

LX-96
150 mm

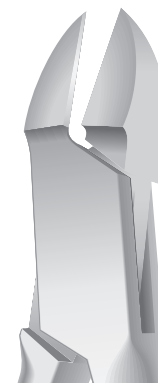

1/1



Mit Hartmetalleinsätzen
With Hard Metal Inserts
Con punte in metallo duro
Con puntas de metal duro
Avec mors en métal dur

○ Max Ø 1.0 mm (.040")

Seitenschneider
Side Cutters
Taglio laterale
De corte lateral
Coupante latérale

Für harten Draht
For hard Wire
Per fili grossi e duri
Para alambre duro
Pour fil dur

LX-96TC
150 mm

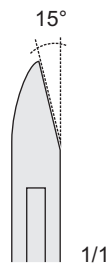
Schneidezangen
Ligaturen-CutterCutters
Ligature CuttersTronchesi
Tronchesi per legatureAlicates de corte
Alicates para cortar ligadurasPinces coupantes
Pinces coupe-ligatures

Mit Hartmetalleinsätzen
With Hard Metal Inserts
Con punte in metallo duro
Con puntas de metal duro
Avec mors en métal dur

- Max Ø 0.7 mm (.028")
- 0.56 x 0.71 mm (.022" x .028")
- ⊗ 0.53 x 0.64 mm (.021" x .025")

Für harten Draht
For hard Wire
Per fili duri, grossi e intrecciati
Para alambre duro
Pour fil dur

LX-90
125 mm

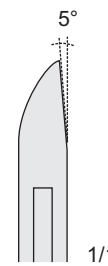

Mit Hartmetalleinsätzen
With Hard Metal Inserts
Con punte in metallo duro
Con puntas de metal duro
Avec mors en métal dur

- Max Ø 0.7 mm (.028")
- 0.56 x 0.71 mm (.022" x .028")
- ⊗ 0.53 x 0.64 mm (.021" x .025")

Für harten Draht
For hard Wire
Per fili duri, grossi e intrecciati
Para alambre duro
Pour fil dur

LX-91
125 mm

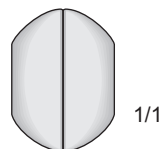
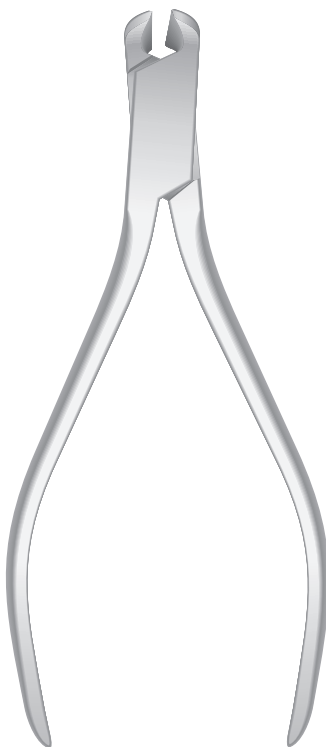

Kopfschneider
End Cutters
Tronchese frontale
Cortafrios frontal
Pince coupante droite

- Max Ø 1.0 mm (.040")

Für harten Draht
For hard Wire
Per fili duri e grossi
Para alambre duro
Pour fil dur

LX-92
145 mm

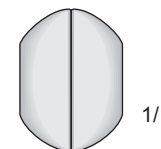

Mit Hartmetalleinsätzen
With Hard Metal Inserts
Con punte in metallo duro
Con puntas de metal duro
Avec mors en métal dur

Kopfschneider
End Cutters
Tronchese frontale
Cortafrios frontal
Pince coupante droite

- Max Ø 1.0 mm (.040")

Für harten Draht
For hard Wire
Per fili duri e grossi
Para alambre duro
Pour fil dur

LX-92TC
145 mm

Ligaturen
Schneidezangen -Mini

Mini
Ligature Cutters

Mini Tronchesino
per legature

Mini Alicates
para cortar ligaduras

Mini Pincers
coupe-ligatures

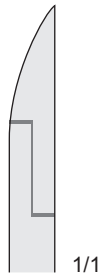
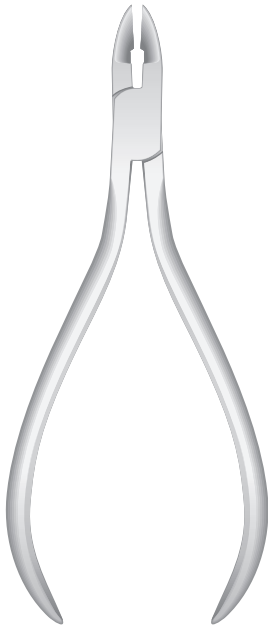

Mit Hartmetalleinsätzen
With Hard Metal Inserts
Con punte in metallo duro
Con puntas de metal duro
Avec mors en métal dur

○ Max Ø 0.2 mm (.010")

Ligaturen Schneidezange
Ligature Cutters
Solo per rimuovere le legature
Alicates para cortar ligaduras
Pince à sectionner les ligatures

Für weichen Draht
For soft Wire
Per fili sottili e morbidi
Para alambre blando
Pour fil léger

LX-86
125 mm

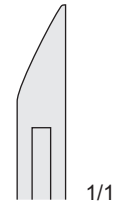
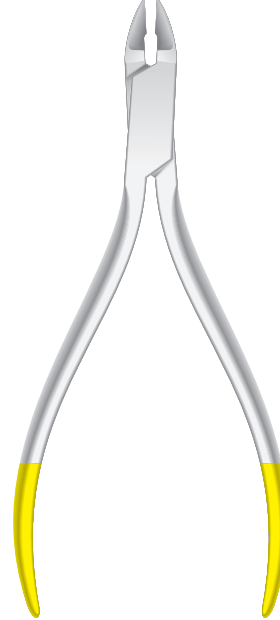

Mit Hartmetalleinsätzen
With Hard Metal Inserts
Con punte in metallo duro
Con puntas de metal duro
Avec mors en métal dur

○ Max Ø 0.3 mm (.012")

Ligaturen Schneidezange
Ligature Cutters
Solo per rimuovere le legature
Alicates para cortar ligaduras
Pince à sectionner les ligatures

Für weichen Draht
For soft Wire
Per fili sottili e morbidi
Para alambre blando
Pour fil léger

LX-93
125 mm

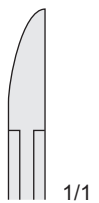
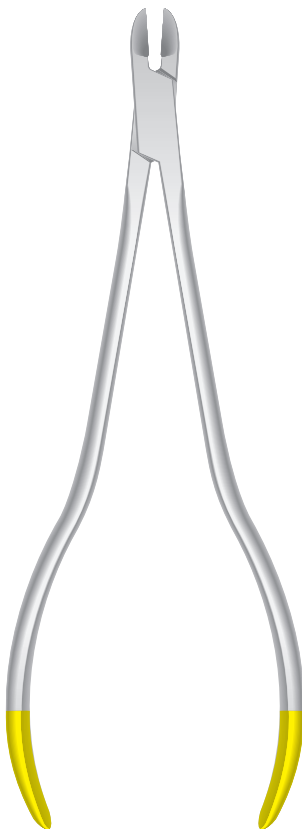

Mit Hartmetalleinsätzen
With Hard Metal Inserts
Con punte in metallo duro
Con puntas de metal duro
Avec mors en métal dur

○ Max Ø 0.3 mm (.012")

Long Handle
Con manici lunghi

Ligaturen Schneidezangen -Mini
Mini Ligature Cutter
Solo per rimuovere le legature
Alicates de corte mini
Pince coupante mini

Für weichen Draht
For soft Wire
Per fili sottili e morbidi
Para alambre blando
Pour fil léger

LX-98
175 mm

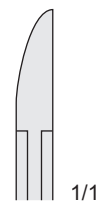

Mit Hartmetalleinsätzen
With Hard Metal Inserts
Con punte in metallo duro
Con puntas de metal duro
Avec mors en métal dur

○ Max Ø 0.3 mm (.012")

Ligaturen Schneidezangen -Mini
Mini Ligature Cutter
Solo per rimuovere le legature
Alicates de corte mini
Pince coupante mini

Für weichen Draht
For soft Wire
Per fili sottili e morbidi
Para alambre blando
Pour fil léger

LX-97
120 mm

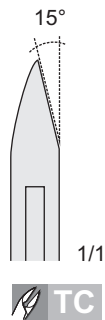
Schneidezangen
Ligaturen-CutterCutters
Ligature CuttersTronchesi
Tronchesi per legatureAlicates de corte
Alicates para cortar ligadurasPinces coupantes
Pinces coupe-ligatures

Mit Hartmetalleinsätzen
With Hard Metal Inserts
Con punte in metallo duro
Con puntas de metal duro
Avec mors en métal dur

- Max Ø 0.5 mm (.020")
- 0.41 x 0.56 mm (.016" x .022")

Ligature Cutter
Angled 15°

Für weichen und harten Draht
For soft and hard Wire
Per fili duri, sottili e medi
Para alambre blando y duro
Pour fil léger e dur

LX-94
125 mm

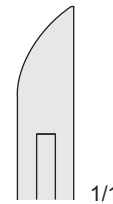

Mit Hartmetalleinsätzen
With Hard Metal Inserts
Con punte in metallo duro
Con puntas de metal duro
Avec mors en métal dur

- Max Ø 0.5 mm (.020")
- 0.41 x 0.56 mm (.016" x .022")

Für weichen und harten Draht
For soft and hard Wire
Per fili duri, sottili e medi
Para alambre blando y duro
Pour fil léger e dur

LX-99
120 mm

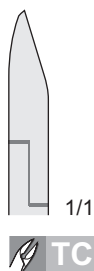

Mit Hartmetalleinsätzen
With Hard Metal Inserts
Con punte in metallo duro
Con puntas de metal duro
Avec mors en métal dur

- Max Ø 0.4 mm (.016")

Ligaturen-Cutter
Ligature Cutter

Für weichen und harten Draht
For soft and hard Wire
Per filo leggero e duro
Para alambre blando y duro
Pour fil léger e dur

LX-88
115 mm

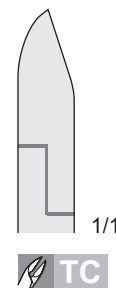

Mit Hartmetalleinsätzen
With Hard Metal Inserts
Con punte in metallo duro
Con puntas de metal duro
Avec mors en métal dur

- Max Ø 0.7 mm (.028")
- 0.56 x 0.71 mm (.022" x .028")
- ⊗ 0.53 x 0.64 mm (.021" x .025")

Bogen-Cutter
Arch Cutter

Für weichen und harten Draht
For soft and hard Wire
Per fili duri, grossi e intrecciati
Para alambre blando y duro
Pour fil léger e dur

LX-89
120 mm

**Distal-Schneider
mit Drahtfangvorrichtung**

**Distal Cutters with
wire holding device**

**Tronchesi distali con
trattenuta del filo**

**Alicates de corte
distal con dispositivo
retenedor del alambre**

**Pinces à couper distale
avec dispositif de
rétention**

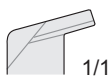

Mit Hartmetalleinsätzen
With Hard Metal Inserts
Con punte in metallo duro
Con puntas de metal duro
Avec mors en métal dur

- Max Ø 0.5 mm (.020")
- 0.41 x 0.56 mm (.016" x .022")
- ⊗ Max Ø 0.4 mm (.0155")

Distal-Schneider mit Drahtfangvorrichtung
Distal Cutter with wire holding device
Tronchesi distale con trattenuta del filo
Alicates de corte distal con dispositivo
retenedor del alambre
Pinces à couper distale avec
dispositif de rétention

Für weichen und harten Draht
For soft and hard Wire
Per fili duri, sottili e medi
Para alambre blando y duro
Pour fil léger e dur

LX-DS6
125 mm



Mit Hartmetalleinsätzen
With Hard Metal Inserts
Con punte in metallo duro
Con puntas de metal duro
Avec mors en métal dur

- Max Ø 0.5 mm (.020")
- 0.41 x 0.56 mm (.016" x .022")
- ⊗ Max Ø 0.4 mm (.0155")

Distal-Schneider mit Drahtfangvorrichtung
Distal Cutter with wire holding device
Tronchesi distale con trattenuta del filo
Alicates de corte distal con dispositivo
retenedor del alambre
Pinces à couper distale avec
dispositif de rétention

Für weichen und harten Draht
For soft and hard Wire
Per fili duri, sottili e medi
Para alambre blando y duro
Pour fil léger e dur

LX-DS1
125 mm

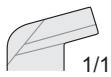

Mit Hartmetalleinsätzen
With Hard Metal Inserts
Con punte in metallo duro
Con puntas de metal duro
Avec mors en métal dur

- Max Ø 0.4 mm (.016")
- 0.41 x 0.41 mm (.016" x .016")

Distal-Schneider mit Drahtfangvorrichtung
Distal Cutter with wire holding device
Tronchesi distale con trattenuta del filo
Alicates de corte distal con dispositivo
retenedor del alambre
Pinces à couper distale avec
dispositif de rétention

Für weichen und harten Draht
For soft and hard Wire
Per fili duri e sottili
Para alambre blando y duro
Pour fil léger e dur

LX-DS2
125 mm

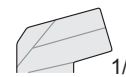

Mit Hartmetalleinsätzen
With Hard Metal Inserts
Con punte in metallo duro
Con puntas de metal duro
Avec mors en métal dur

- Max Ø 0.5 mm (.020")
- 0.41 x 0.56 mm (.016" x .022")
- ⊗ Max Ø 0.4 mm (.0155")

Distal-Schneider mit Drahtfangvorrichtung
Distal Cutter with wire holding device
Tronchesi distale con trattenuta del filo
Alicates de corte distal con dispositivo
retenedor del alambre
Pinces à couper distale avec
dispositif de rétention

Für weichen und harten Draht
For soft and hard Wire
Per fili duri, sottili e medi
Para alambre blando y duro
Pour fil léger e dur

LX-DS4
125 mm

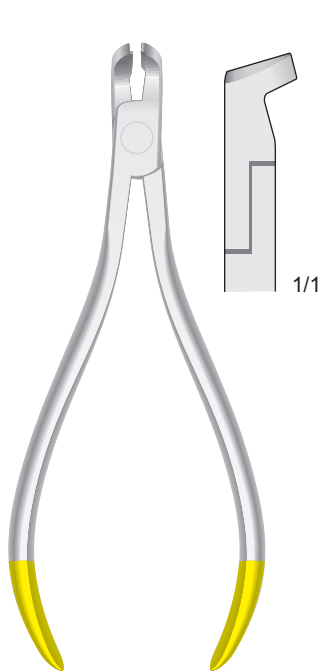
**Distal-Schneider
mit Drahtfangvorrichtung****Distal Cutters with
wire holding device****Tronchesi distali con
trattenuta del filo****Alicates de corte
distal con dispositivo
retenedor del alambre****Pinces à couper distale
avec dispositif de
rétention**

Mit Hartmetalleinsätzen
With Hard Metal Inserts
Con punte in metallo duro
Con puntas de metal duro
Avec mors en métal dur

- Max Ø 0.5 mm (.020")
- 0.41 x 0.56 mm (.016" x .022")
- ⌘ Max Ø 0.4 mm (.0155")

Distal-Schneider mit Drahtfangvorrichtung
Distal Cutter with wire holding device
Tronchesi distale con trattenuta del filo
Alicates de corte distal con dispositivo
retenedor del alambre
Pinces à couper distale avec
dispositif de rétention

Für weichen und harten Draht
For soft and hard Wire
Per fili duri, sottili e medi
Para alambre blando y duro
Pour fil léger e dur

LX-DS5
120 mm

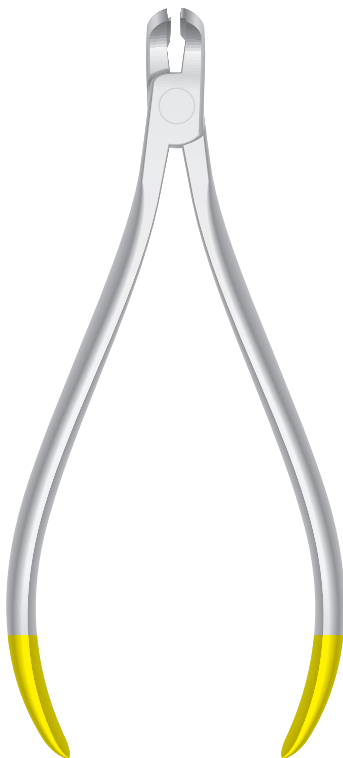

Mit Hartmetalleinsätzen
With Hard Metal Inserts
Con punte in metallo duro
Con puntas de metal duro
Avec mors en métal dur

- Max Ø 0.5 mm (.020")
- 0.41 x 0.56 mm (.016" x .022")
- ⌘ Max Ø 0.4 mm (.0155")

Distal-Schneider mit Drahtfangvorrichtung
Distal Cutter with wire holding device
Tronchesi distale con trattenuta del filo
Alicates de corte distal con dispositivo
retenedor del alambre
Pinces à couper distale avec
dispositif de rétention

Long Handle
Con manici lunghi

Für weichen und harten Draht
For soft and hard Wire
Per fili duri, sottili e medi
Para alambre blando y duro
Pour fil léger e dur

LX-DS3
150 mm

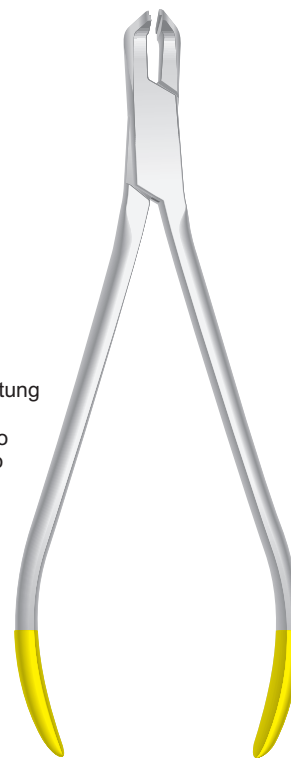

Mit Hartmetalleinsätzen
With Hard Metal Inserts
Con punte in metallo duro
Con puntas de metal duro
Avec mors en métal dur

- Max Ø 0.5 mm (.020")
- 0.41 x 0.56 mm (.016" x .022")
- ⌘ Max Ø 0.4 mm (.0155")

Distal-Schneider mit Drahtfangvorrichtung
Distal Cutter with wire holding device
Tronchesi distale con trattenuta del filo
Alicates de corte distal con dispositivo
retenedor del alambre
Pinces à couper distale avec
dispositif de rétention

Für weichen und harten Draht
For soft and hard Wire
Per fili duri, sottili e medi
Para alambre blando y duro
Pour fil léger e dur

LX-DS6L
150 mm

Kieferorthopädie Zangen
Orthodontics Pliers
Pinze per ortodonzia
Alicates para ortodoncia
Pinces pour Orthodontie



BONTEMPI
CHIRURGISCHE INSTRUMENTE

Passion for excellence

Drahtbiegeezangen

Wire bending Pliers

Pinze per piegare fili

Alicates para doblar alambre

Pinces à courber les fils



DP-31
125 mm

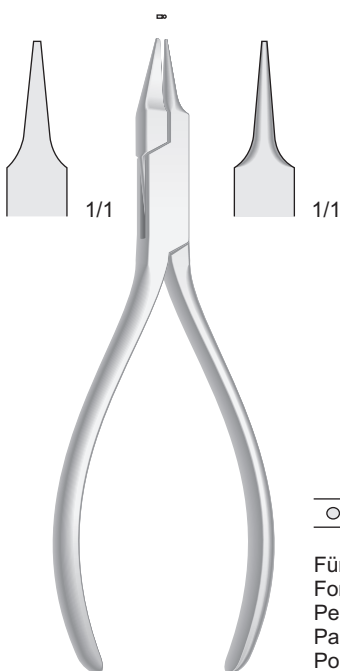

DP-55
135 mm

○ Max Ø 0.5 mm (.020")

Für weichen Draht
For soft Wire
Per filo leggero
Para alambre blando
Pour fil léger



DP-57
130 mm

○ Max Ø 0.5 mm (.020")

Für weichen Draht
For soft Wire
Per filo leggero
Para alambre blando
Pour fil léger

**Light Wire-Biegezange,
Begg Typ**

**Begg-type light wire
Bending Pliers**

**Pinze a becco
di uccello**

**Alicates para doblar,
tipo Begg**

**Pinces à courber
type Begg**

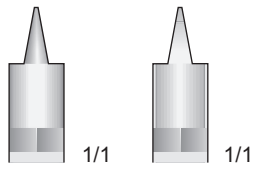

○ Max Ø 0.6 mm (.024")

Lightwire-Zange mit Schneider
Light wire Plier with cutter
Pinza per filo leggero
con tronchese
Alicates para alambre ligero
con dispositivo para cortar
Pince pour light wire avec trancher

DP-106
135 mm

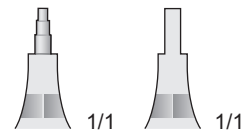

○ Max Ø 0.4 mm (.016")

Lightwire-Zange mit Schneider
Light wire Plier with cutter
Pinza per filo leggero
con tronchese
Alicates para alambre ligero
con dispositivo para cortar
Pince pour light wire avec trancher

DP-108
135 mm

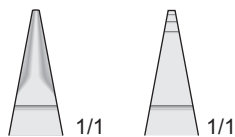

○ Max Ø 0.7 mm (.028")

DP-26
130 mm

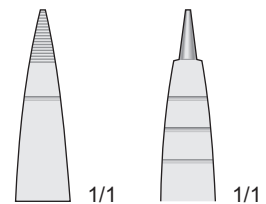

○ Max Ø 0.7 mm (.028")

JARABAK
DP-63
140 mm

Light Wire-Biegezange,
Begg Typ

Begg-type light wire
Bending Pliers

Pinze a becco
di uccello

Alicates para doblar,
tipo Begg

Pincers à courber
type Begg

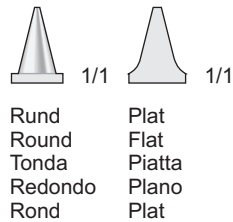

Rund
Round
Tonda
Redondo
Rond

Plat
Flat
Piatta
Plano
Plat

○ Max Ø 0.7 mm (.028")

Für weichen und harten Draht
For soft and hard Wire
Per filo leggero e duro
Para alambre blando y duro
Pour fil léger e dur

ANGLE
DP-01
125 mm

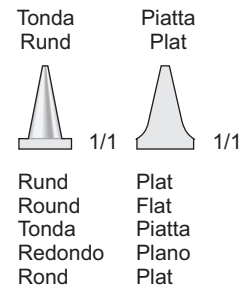

Tonda
Rund

Piatta
Plat

Rund
Round
Tonda
Redondo
Rond

Plat
Flat
Piatta
Plano
Plat



Mit Hartmetalleinsätzen
With Hard Metal Inserts
Con punte in metallo duro
Con puntas de metal duro
Avec mors en métal dur

○ Max Ø 0.7 mm (.028")

Für weichen und harten Draht
For soft and hard Wire
Per filo leggero e duro
Para alambre blando y duro
Pour fil léger e dur

ANGLE
DP-01TC
125 mm

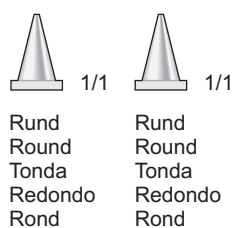

Rund
Round
Tonda
Redondo
Rond

Rund
Round
Tonda
Redondo
Rond

○ Max Ø 0.7 mm (.028")

Für weichen und harten Draht
For soft and hard Wire
Per filo leggero e duro
Para alambre blando y duro
Pour fil léger e dur

DP-02
125 mm

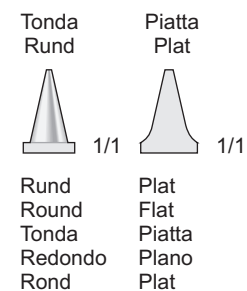

Rund
Round
Tonda
Redondo
Rond

Plat
Flat
Piatta
Plano
Plat

○ Max Ø 0.7 mm (.028")

Für weichen und harten Draht
For soft and hard Wire
Per filo leggero e duro
Para alambre blando y duro
Pour fil léger e dur

ANGLE
DP-07
125 mm

Spezialzangen

Special Pliers
Utility Pliers

Pinze di utilità
Pinze speciali

Alicates especiales

Pinces spéciales

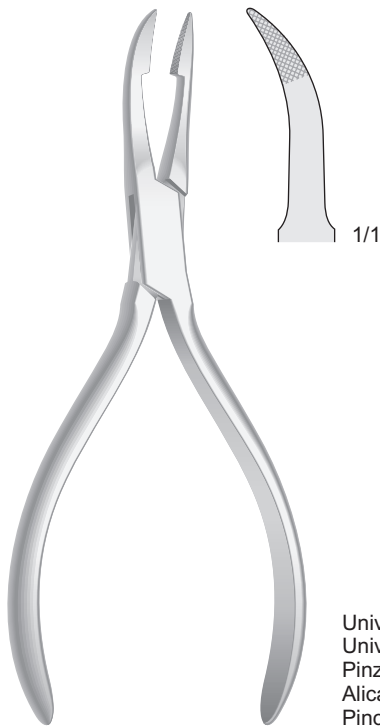

WEINGART
DP-03
145 mm

Universalzange
Universal Pliers
Pinze universali
Alicates universales
Pince universelle

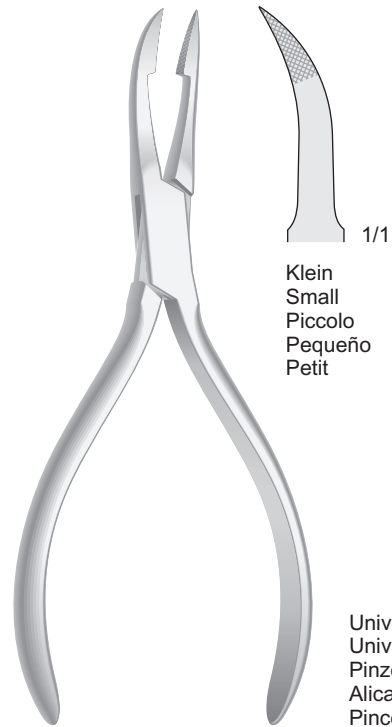

WEINGART
DP-03S
145 mm

Universalzange
Universal Pliers
Pinze universali
Alicates universales
Pince universelle

Klein
Small
Piccolo
Pequeño
Petit



WEINGART
DP-112
140 mm



Mit Hartmetalleinsätzen
With Hard Metal Inserts
Con punte in metallo duro
Con puntas de metal duro
Avec mors en métal dur

Universalzange
Universal Pliers
Pinze universali
Alicates universales
Pince universelle



WEINGART
DP-113
140 mm

Universalzange
Universal Pliers
Pinze universali
Alicates universales
Pince universelle

Spezialzangen

Special Pliers
Utility Pliers

Pinze di utilità
Pinze speciali

Alicates especiales

Pinces spéciales



HOW
DP-05/DP-05S
145 mm

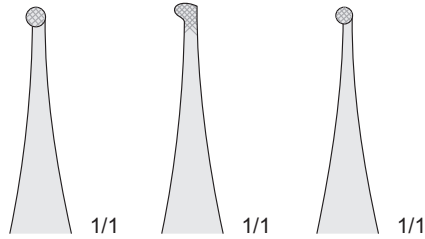

DP-05
145 mm

DP-05L
145 mm

DP-05S
145 mm

Klein
Small
Piccolo
Pequeño
Petit

Universalzange für die Multibandtechnik
Universal Forceps for Multiband Technique
Pinze di utilità per archi
Alicates para formar bandas
Pinces à former les rubans



HOW
DP-06/DP-06S
140 mm

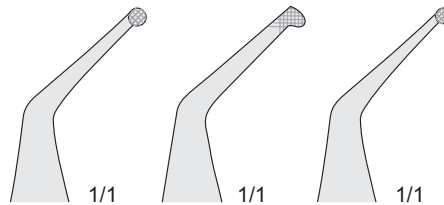

DP-06
145 mm

DP-06L
145 mm

DP-06S
145 mm

Klein
Small
Piccolo
Pequeño
Petit

Universalzange für die Multibandtechnik
Universal Forceps for Multiband Technique
Pinze di utilità per archi
Alicates para formar bandas
Pinces à former les rubans

Drahtbiegeezangen

Wire Bending Pliers

Pinze per piegare fili

Alicates para doblar alambres

Pinces à pliers les fils



○ Max Ø 0.5 mm (.020")

Für weichen und harten Draht
For soft and hard Wire
Per filo leggero e duro
Para alambre blando y duro
Pour fil léger e dur

**ADERER
DP-44**
115 mm

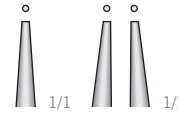

○ Max Ø 0.6 mm (.024")

Für weichen und harten draht
For soft and hard wire
Per filo leggero e duro
Para alambre blando y duro
Pour fil mou et dur

**ADERER
DP-123**
125 mm

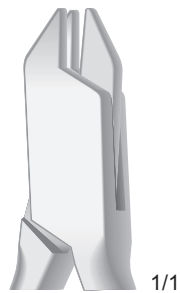

Modello robusto
Modelo robusto
Modèle fort

○ Max Ø 0.9 mm (.036")

Für weichen und harten Draht
For soft and hard Wire
Per filo leggero e duro
Para alambre blando y duro
Pour fil léger e dur

**ADERER
DP-25**
125 mm



○ Max Ø 0.7 mm (.028")

Für weichen und harten Draht
For soft and hard Wire
Per filo leggero e duro
Para alambre blando y duro
Pour fil léger e dur

**ADERER
DP-40**
125 mm

Drahtbiegeezangen

Wire Bending Pliers

Pinze per piegare fili

Alicates para doblar alambres

Pinces à pliers les fils

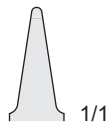

○ Max Ø 0.7 mm (.028")

Für weichen und harten Draht
For soft and hard Wire
Per filo leggero e duro
Para alambre blando y duro
Pour fil léger e dur

ADAMS
DP-47
125 mm



1,0 x 1,0 mm

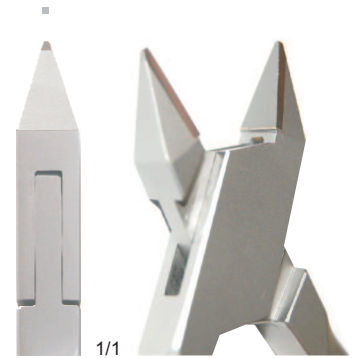

○ Max Ø 1.0 mm (.040")

Pinza da ortodonzia tipo ASH
in acciaio inossidabile con inserti al
Carburo di Tungsteno.
I becchi sono temprati per una presa
ottimale sul filo d'acciaio.

DP-145
135 mm

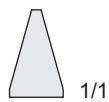

○ Max Ø 0.7 mm (.028")

Für weichen und harten Draht
For soft and hard Wire
Per filo leggero e duro
Para alambre blando y duro
Pour fil léger e dur

ADAMS
DP-43
125 mm

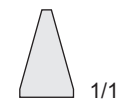

Mit Hartmetalleinsätzen
With Hard Metal Inserts
Con punte in metallo duro
Con puntas de metal duro
Avec mors en métal dur

○ Max Ø 0.7 mm (.028")

Für weichen und harten Draht
For soft and hard Wire
Per filo leggero e duro
Para alambre blando y duro
Pour fil léger e dur

ADAMS
DP-43TC
125 mm

Bogenbiegeezangen Arch Forming Pliers Pinze per formare archi Alicates para doblar arcos Pincas à courber les arcs

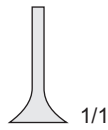

- Max Ø 0.7 mm (.028")
- 0.56 x 0.71 mm (.022" x .028")

Für Vierkant-Drähte
For Edgewise wires
Per fili quadrati
Para alambres rectangulares
Pour fils rectangulaire

ANGLE-TWEED
DP-60
130 mm



Diametro del filo fino a .025

10 mm

1/1

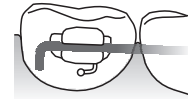
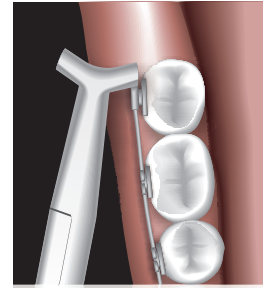

Per ottenere la piegatura del filo verso il basso:
posizionare la pinza Hammerhead parallela alla base del dente, con il lato femmina rivolto verso il basso.

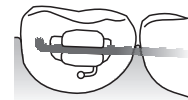

Per ottenere la piegatura del filo verso il dente:
posizionare la pinza Hammerhead perpendicolare alla base del dente, con il lato femmina rivolto verso il dente.

HAMMERHEAD
DP-143
155 mm

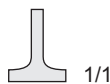

- Max Ø 0.7 mm (.028")
- 0.56 x 0.71 mm (.022" x .028")

Für Vierkant-Drähte
For Edgewise wires
Per fili quadrati
Para alambres rectangulares
Pour fils rectangulaire

ANGLE-TWEED
DP-76
125 mm

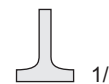

Mit Hartmetalleinsätzen
With Hard Metal Inserts
Con punte in metallo duro
Con puntas de metal duro
Avec mors en métal dur

- Max Ø 0.7 mm (.028")
- 0.56 x 0.71 mm (.022" x .028")

Für Vierkant-Drähte
For Edgewise wires
Per fili quadrati
Para alambres rectangulares
Pour fils rectangulaire

ANGLE-TWEED
DP-76TC
125 mm

Drahtbiegeezangen

Wire Bending Pliers

Pinze per piegare fili

Alicates para doblar alambres

Pinces à plier les fils



TORQUE
DP-141A
125 mm

○ Max Ø 0,55 x 0,64 mm



TORQUE
DP-141B
125 mm

○ Max Ø 0,55 x 0,64 mm

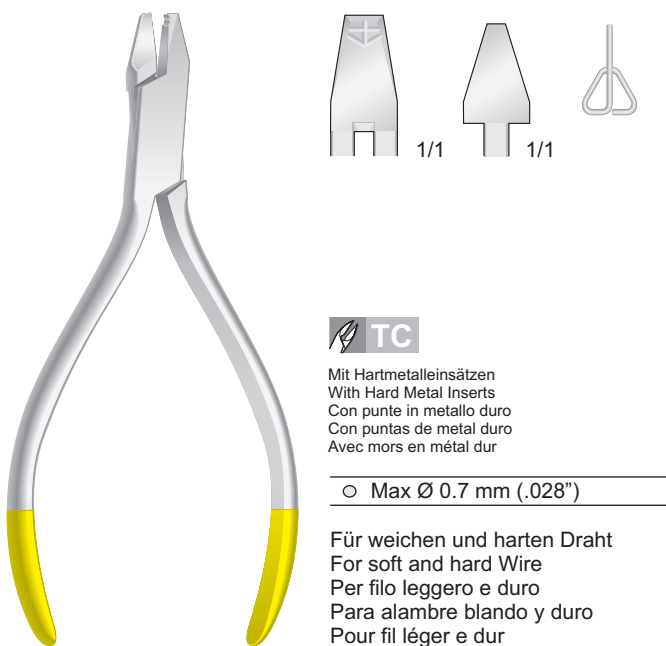

DP-110
125 mm



Mit Hartmetalleinsätzen
With Hard Metal Inserts
Con punte in metallo duro
Con puntas de metal duro
Avec mors en métal dur

○ Max Ø 0.7 mm (.028")

Für weichen und harten Draht
For soft and hard Wire
Per filo leggero e duro
Para alambre blando y duro
Pour fil léger e dur

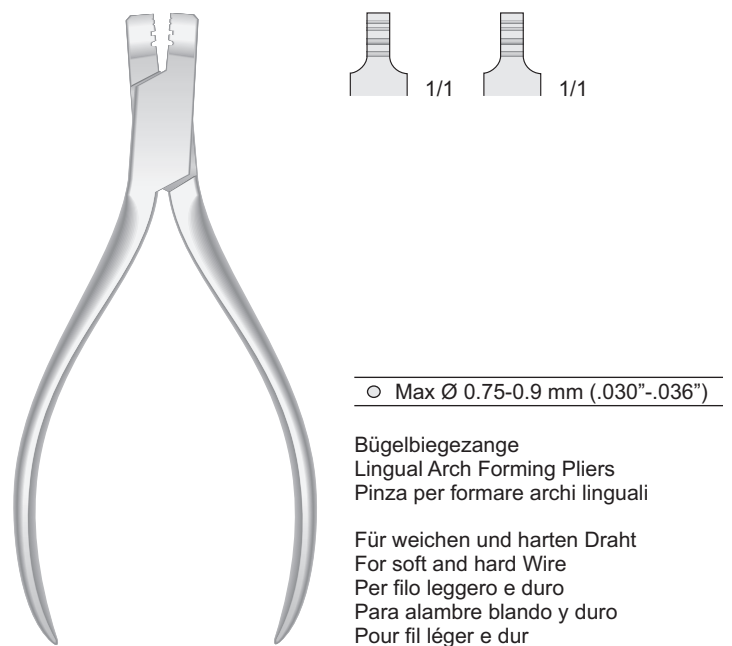

DP-107
125 mm

○ Max Ø 0.75-0.9 mm (.030"-0.036")

Bügelbiegezange
Lingual Arch Forming Pliers
Pinza per formare archi linguali

Für weichen und harten Draht
For soft and hard Wire
Per filo leggero e duro
Para alambre blando y duro
Pour fil léger e dur

Schlaufen und
Bogenbiegezangen

Loop and Arch
Forming Pliers

Pinze per anse
e per formare archi

Alicates para ansas
para formar arcos

Pinces à former les
anses et les arcs



TWEED
DP-115
135 mm

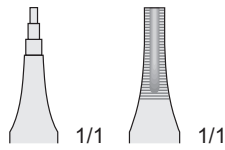

○ Max Ø 0.7 mm (.028")

Für weichen und harten Draht
For soft and hard Wire
Per filo leggero e duro
Para alambre blando y duro
Pour fil léger e dur



TWEED
DP-70/DP-70A

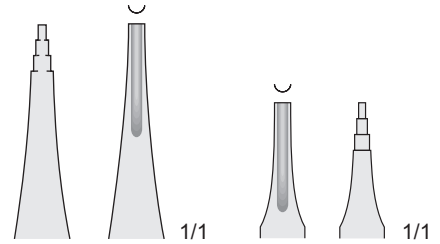

DP-70
140 mm

DP-70A
135 mm

○ Max Ø 0.5 mm (.020")

Für weichen und harten Draht
For soft and hard Wire
Per filo leggero e duro
Para alambre blando y duro
Pour fil léger e dur



DE LA ROSA
DP-79/DP-79A
125 mm

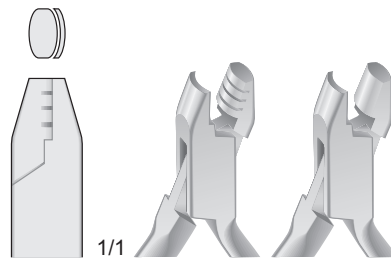

DP-79 DP-79A

DP-79
Mit Führungsrillen 016" - .018" - .022"
With Groove Guides 016" - .018" - .022"
Con guide per 016" - .018" - .022"
Con guida para 016" - .018" - .022"
Avec guidage de 016" - .018" - .022"

Konturenzangen
Arch contouring Pliers
Pinze per formare archi
Alicates para formar arcos
Pinces pour former les arcs

Pinze per formare loop



NANCE
DP-81
125 mm

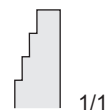

○ Max Ø 0.7 mm (.028")

Schlaufen-Biegezange
Loop Bending Pliers
Pinza per anse
Alicates para formar ansas
Pince à former les anses

Schlaufen und
Bogenbiegezaugen

Loop and Arch
Forming Pliers

Pinze per anse
e per formare archi

Alicates para ansas
para formar arcos

Pincès à former les
anses et les arcs



TWEED
DP-72
135 mm

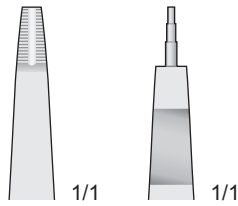

○ Max Ø 0.7 mm (.028")

Mit auswechselbarer Hartmetallspitze
With Replacable tool steel tips
Con vite per stop e punta sostituibile
Con punta de acero duro recambiable
Avec embout en métal dur interchangeable

Für weichen und harten Draht
For soft and hard Wire
Per filo leggero e duro
Para alambre blando y duro
Pour fil léger e dur



DP-72R

Ersatzspitzen
Replacements tips
Punta di ricambio
Punta de recambio
Embout de rechange



TWEED
DP-74
140 mm

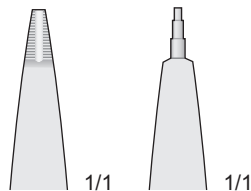

○ Max Ø 0.7 mm (.028")

Für weichen und harten Draht
For soft and hard Wire
Per filo leggero e duro
Para alambre blando y duro
Pour fil léger e dur



YOUNG
DP-73
130 mm

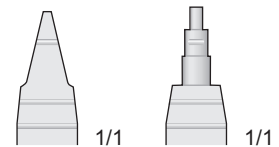

○ Max Ø 0.7 mm (.028")

Für weichen und harten Draht
For soft and hard Wire
Per filo leggero e duro
Para alambre blando y duro
Pour fil léger e dur

Hohlkehllzangen Loop Forming Pliers, Gauge Pinze scanlate, concave e convesse Alicates acanalados Pincas a mors concave et rond

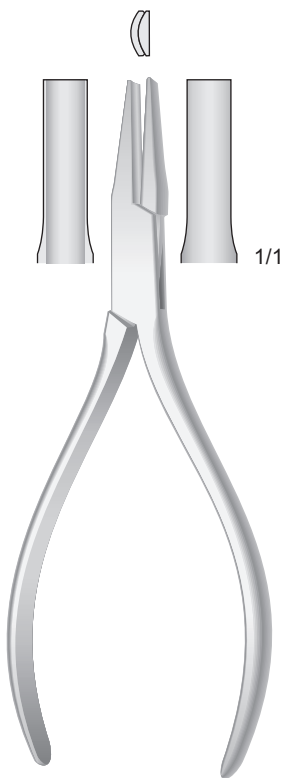

HOLLOW-CHOP
DP-69
140 mm

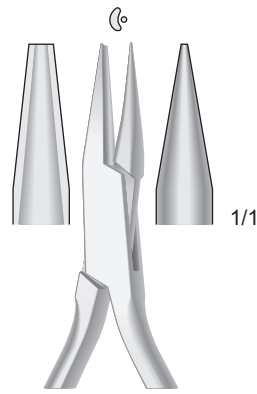

DP-68
140 mm

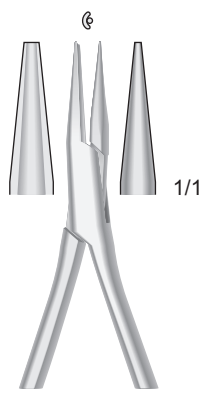

DP-59
125 mm

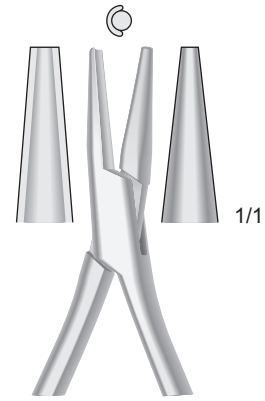

DP-67
130 mm

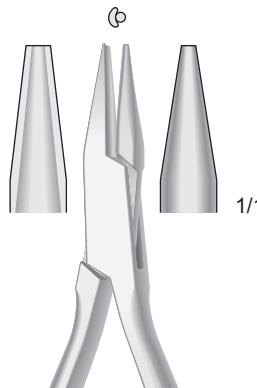

DP-61
135 mm

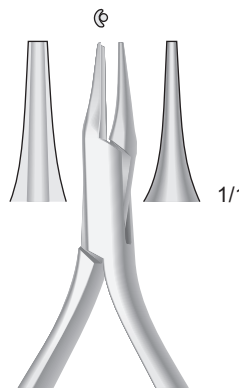

DP-65
135 mm

○ Max Ø 0.5 mm (.020")

Für weichen und harten Draht
For soft and hard Wire
Per filo leggero e duro
Para alambre blando y duro
Pour fil léger e dur



HOLLOW-CHOP
DP-69A
130 mm

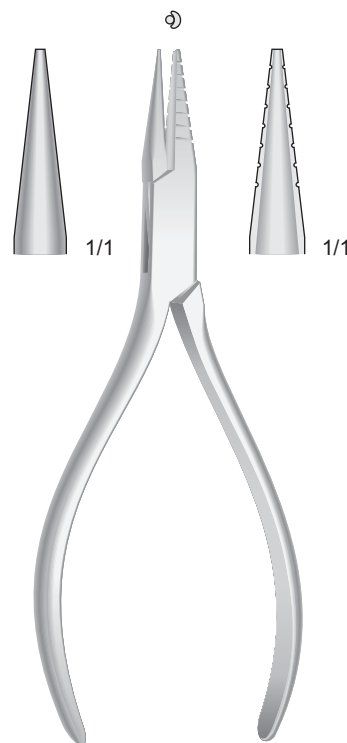

SCHWARZ
DP-58
140 mm

Hohlkehllzangen mit Graduierung
Bending Pliers with graduation
Pinza scanlata con graduazione
Alicates de media caña con graduación
Pince à plier moyenne fine

○ Max Ø 1.0 mm (.039")

Für weichen und harten Draht
For soft and hard Wire
Per filo leggero e duro
Para alambre blando y duro
Pour fil léger e dur

Hohlkehlzangen

Loop Forming
Pliers, Gauge

Pinze scanalate,
concave e convesse

Alicates
acanalados

Pinces a mors
concave et rond

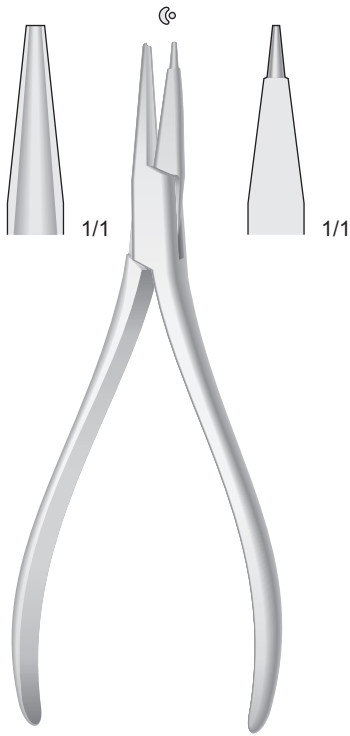

JARABAK
DP-63A
140 mm



ANDERSEN
DP-64
130 mm



MC KELLOPS
DP-62
160 mm

Pinze per formare Loop
Una punta concava e una conica
per fili tondi

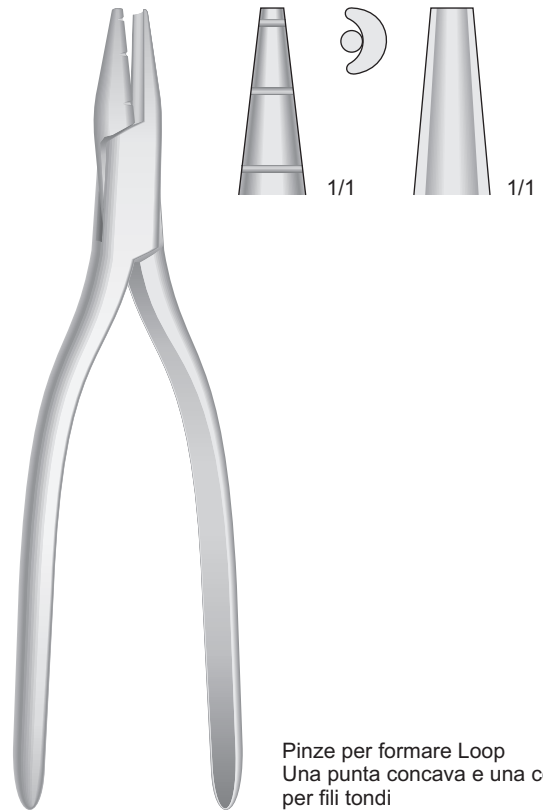

MC KELLOPS
DP-66
160 mm

Pinze per formare Loop
Una punta concava e una conica
per fili tondi

Abnehmezangen

Removing Pliers

Pinze per rimozione

Alicates para remover

Pinces à ôter-enlever

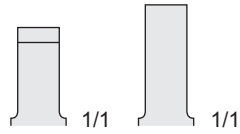

Frontzahn Bandabnehmezange
Anterior Band removing Plier
Pinza per togliere le bande anteriori
Alicates para quitar bandas anteriores
Pince à enlever les bagues antérieures

ADERER
DP-35
130 mm

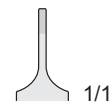

DP-48
125 mm

Bracket-Abnehmezangen
Bracket Removing Pliers
Pinze per rimuovere gli attacchi
diretti (Asporta Brackets)
Alicates para quitar Brackets
Pince à ôter les Brackets



DP-56
135 mm

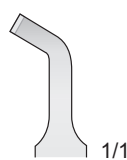

Abgewinkelt 45°
Angulated 45°
Angolata 45°
Angulado 45°
Pliée 45°

DP-78
135 mm

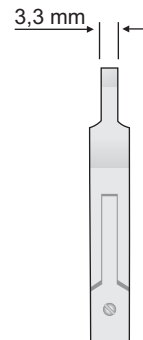

DP-117
135 mm



Mit Hartmetalleinsätzen
With Hard Metal Inserts
Con punte in metallo duro
Con puntas de metal duro
Avec mors en métal dur

Bandabnehmzangen

Removing Pliers

Pinze per rimuovere
le bande

Alicates para
remover bandas

Pince à enlever
les bagues



ADERER
DP-36T
135 mm



Bandabnehmmezange
Band remover
Pinza per rimuovere le bande
Alicates para quitar bandas
Pinces à détacher les bagues

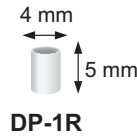

DP-1R

Ersatz-Plastikschutzkappen für:
Replacements Plastic tips for:
Punte di ricambio in teflon per:
Puntas de recambio de plástico para:
Pointes plastiques interchangeables pour:
DP-36, DP-36TC, DP-37

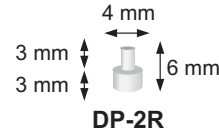

DP-2R

Ersatz-Plastikschutzkappen für:
Replacements Plastic tips for:
Punte di ricambio in teflon per:
Puntas de recambio de plástico para:
Pointes plastiques interchangeables pour:
DP-36T

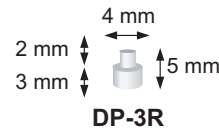

DP-3R

Ersatz-Plastikschutzkappen für:
Replacements Plastic tips for:
Punte di ricambio in teflon per:
Puntas de recambio de plástico para:
Pointes plastiques interchangeables pour:
DP-36T

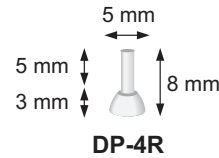

DP-4R

Ersatz-Plastikschutzkappen für:
Replacements Plastic tips for:
Punte di ricambio in teflon per:
Puntas de recambio de plástico para:
Pointes plastiques interchangeables pour:
DP-36T

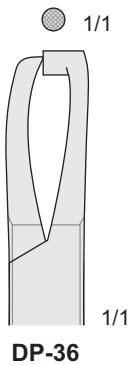

DP-36

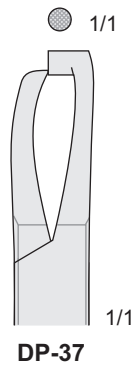

DP-37

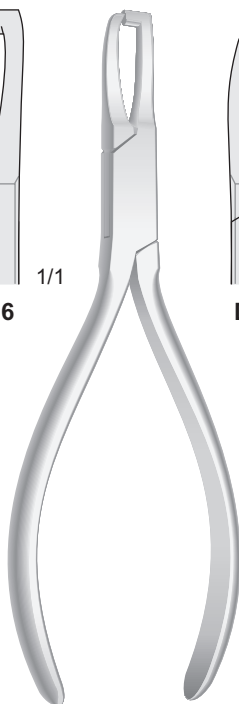

OLIVER
DP-36/DP-37
140 mm

Bandabnehmmezange
Band remover
Pinza per rimuovere le bande
Alicates para quitar bandas
Pinces à détacher les bagues

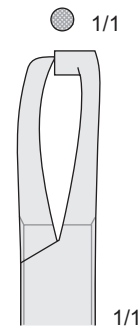

OLIVER
DP-36TC
140 mm



Mit Hartmetalleinsätzen
With Hard Metal Inserts
Con punte in metallo duro
Con puntas de metal duro
Avec mors en métal dur

Bandabnehmmezange
Band remover
Pinza per rimuovere le bande
Alicates para quitar bandas
Pinces à détacher les bagues

Flachzangen

Nose Flat Pliers

Pinze a punte piatte

Alicates planos

Pinces à mors plats

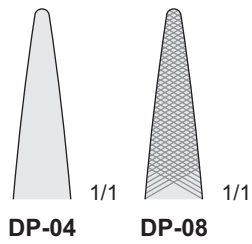
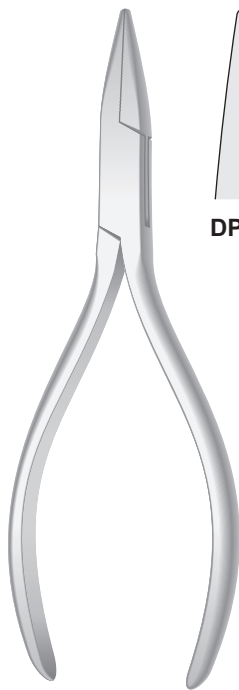

DP-04

DP-08

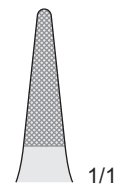

Mit Hartmetalleinsätzen
With Hard Metal Inserts
Con punte in metallo duro
Con puntas de metal duro
Avec mors en métal dur

DP-04/DP-08
140 mm

DP-08TC
140 mm



FISCHER
DP-10
150 mm

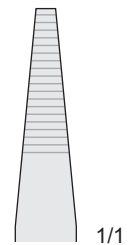
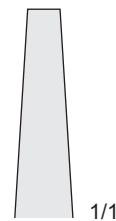
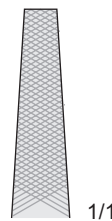
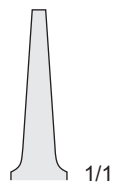
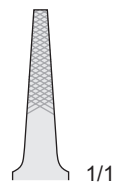
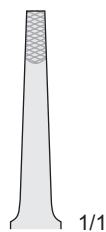

DP-11
135 mm

DP-12
135 mm

DP-13
140 mm

DP-14
140 mm

DP-30
140 mm

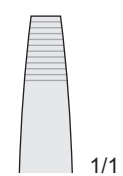
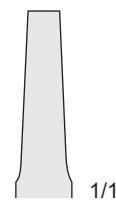
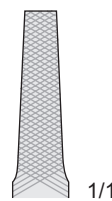
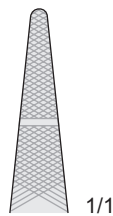
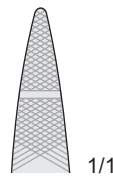

GOSLEE
DP-16
135 mm

GOSLEE
DP-17
140 mm

DP-19
140 mm

DP-20
140 mm

DP-32
140 mm

Flachzangen

Nose Flat Pliers

Pinze a punte piatte

Alicates planos

Pinces à mors plats



GOSLEE
DP-18/DP-18A
140 mm

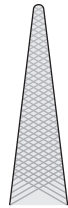

DP-18
140 mm



1/1

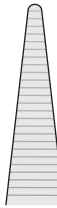

DP-18A
140 mm

1/1

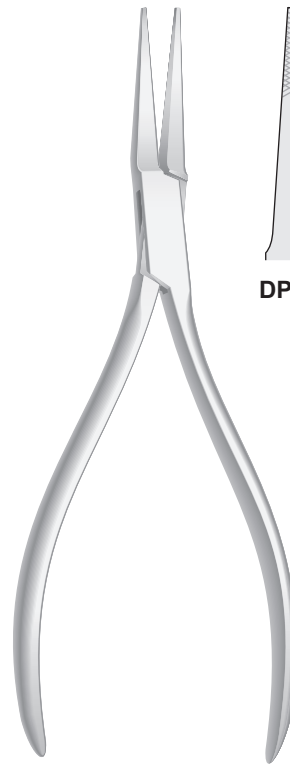

DP-15/DP-15L
150 mm



DP-15

1/1



DP-15L

1/1



OLIVER
DP-39
130 mm



1/1



DP-27
125 mm

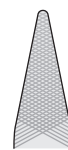

1/1

○ Max Ø 0.7 mm (.028")

Für weichen und harten Draht
For soft and hard Wire
Per filo leggero e duro
Para alambre blando y duro
Pour fil léger e dur

Drahtbiegezangen

Wire bending Pliers

Pinze per piegare fili

Alicates para doblar alambre

Pincès à courber les fils

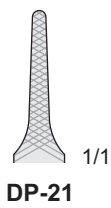

Drahtbiegezange
Wire bending Pliers
Pinza piegafili
Alicates para
doblar alambre
Pincès à courber
les fils

PEESO
DP-21
135 mm

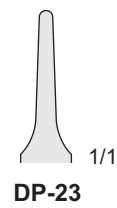

Drahtbiegezange
Wire bending Pliers
Pinza piegafili
Alicates para
doblar alambre
Pincès à courber
les fils

PEESO
DP-23
135 mm

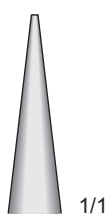

Feines Modell
Fine model
Modello fine

Rundzange
Round Pliers
Pinze con
punta tonda
Alicates de
pico redondo
Pincès à
mors ronds

DP-22
140 mm

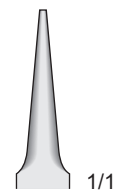

Rundzange
Round Pliers
Pinze con
punta tonda
Alicates de
pico redondo
Pincès à
mors ronds

LANGENBECK
DP-22M
140 mm

Drahtbiegezaugen

Wire bending Pliers

Pinze per piegare fili

Alicates para doblar alambre

Pinces à courber les fils



○ Max Ø 1.0 mm (.039")

Schlaufenbiegezauge
Loop Bending Pliers
Pinze per ansa
Alicates para ansas
Pinces à former les anses

DP-88
140 mm

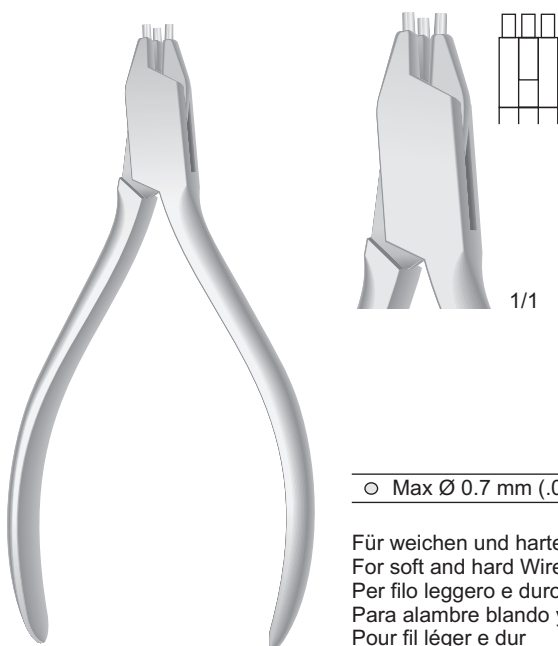

○ Max Ø 0.7 mm (.028")

Für weichen und harten Draht
For soft and hard Wire
Per filo leggero e duro
Para alambre blando y duro
Pour fil léger e dur

DP-87
125 mm

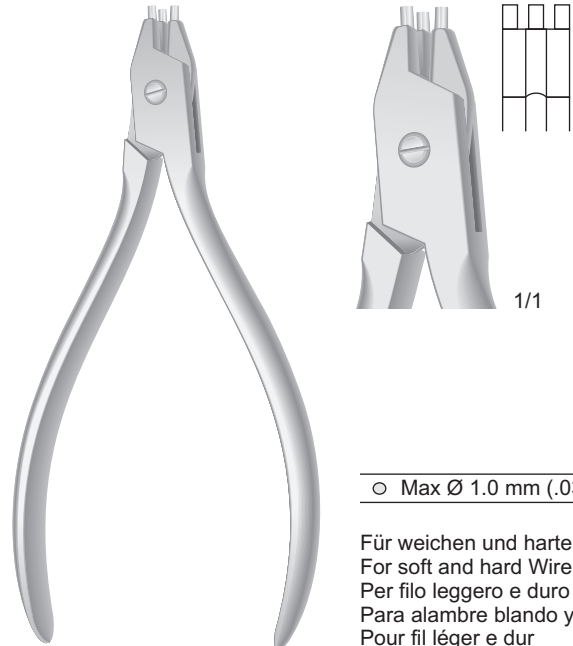

○ Max Ø 1.0 mm (.039")

Für weichen und harten Draht
For soft and hard Wire
Per filo leggero e duro
Para alambre blando y duro
Pour fil léger e dur

DP-87A
130 mm

Drahtbiegeezangen

Wire bending Pliers

Pinze per piegare fili

Alicates para doblar alambre

Pinces à courber les fils

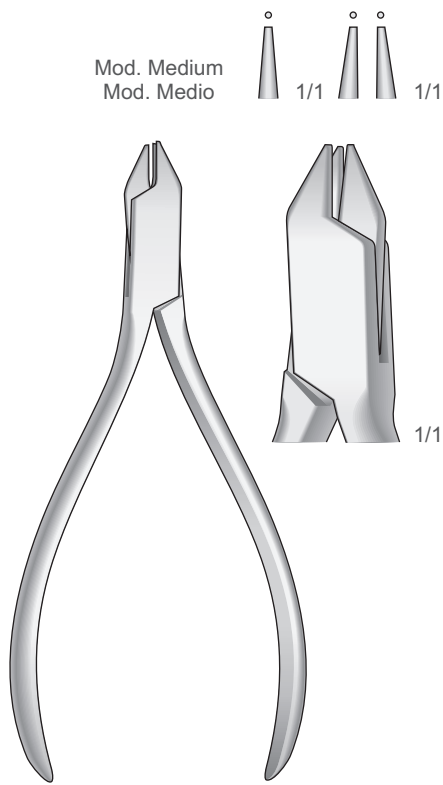

ADERER
DP-116
125 mm

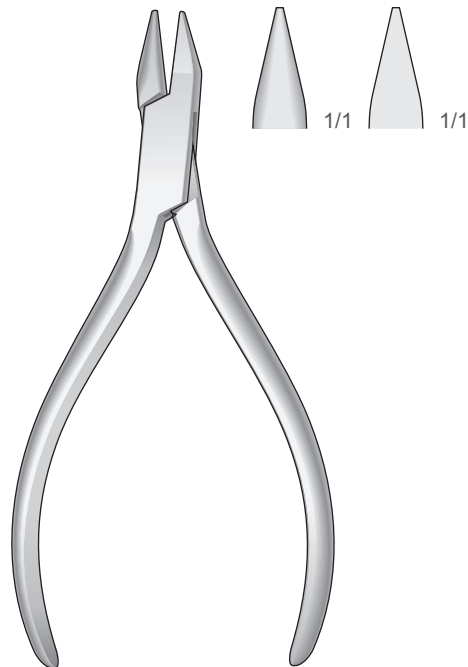

DP-118
130 mm

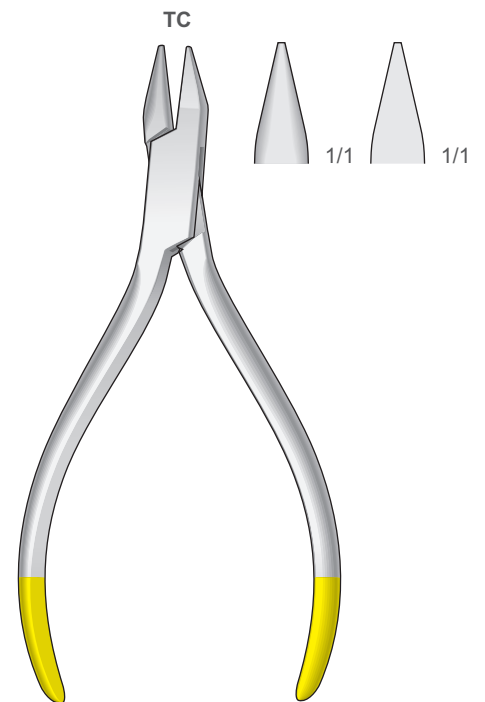

DP-119
130 mm



SCHWARZ
DP-45
130 mm

Pfeilformzange
Arrow Clasp Forming Pliers
Pinza per ganci a freccia
Alicates para forma de flecha
Pince à plier les flèches



NANCE
DP-82
125 mm

Pfeilformzange
Arrow Clasp Forming Pliers
Pinza per ganci a freccia
Alicates para forma de flecha
Pince à plier les flèches

Drahtbiegezangen

Wire bending Pliers

Pinze per piegare fili

Alicates para doblar alambre

Pinces à courber les fils



Für Adams-Klammern
For Adams-Clasp
Pinza per formare ganci di Adams
Para ganchos de Adams
Pour Crochets de Adams

○ Max Ø 0.7 mm (.028")

Für weichen und harten Draht
For soft and hard Wire
Per filo leggero e duro
Para alambre blando y duro
Pour fil léger e dur

ADAMS-NANCE
DP-46
135 mm



○ Max Ø 1.0 mm (.039")

Für weichen und harten Draht
For soft and hard Wire
Per filo leggero e duro
Para alambre blando y duro
Pour fil léger e dur

ADERER
DP-41
145 mm



○ Max Ø 1.0 mm (.039")

Für weichen und harten Draht
For soft and hard Wire
Per filo leggero e duro
Para alambre blando y duro
Pour fil léger e dur

MALLOTHY
DP-42
125 mm

Drahtbiegezaugen

Wire bending Pliers

Pinze per piegare fili

Alicates para doblar alambre

Pinces à courber les fils

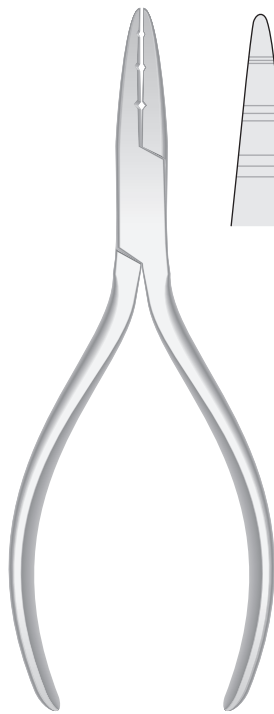

1/1

○ Max Ø 1.0 mm (.039") ○

Für weichen und harten Draht
For soft and hard Wire
Per filo leggero e duro
Para alambre blando y duro
Pour fil léger e dur

**ADERER
DP-77**
140 mm

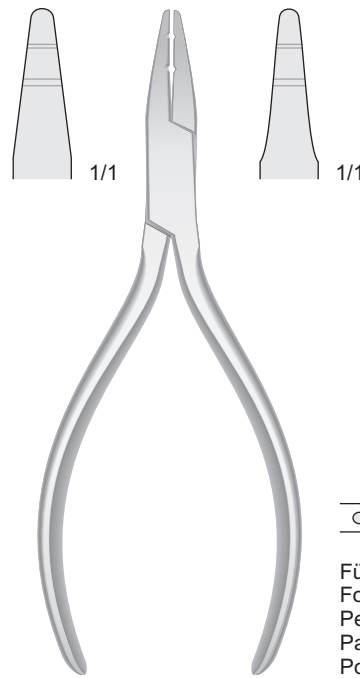

1/1

1/1

○ Max Ø 1.0 mm (.039")

Für weichen und harten Draht
For soft and hard Wire
Per filo leggero e duro
Para alambre blando y duro
Pour fil léger e dur

DP-89
130 mm

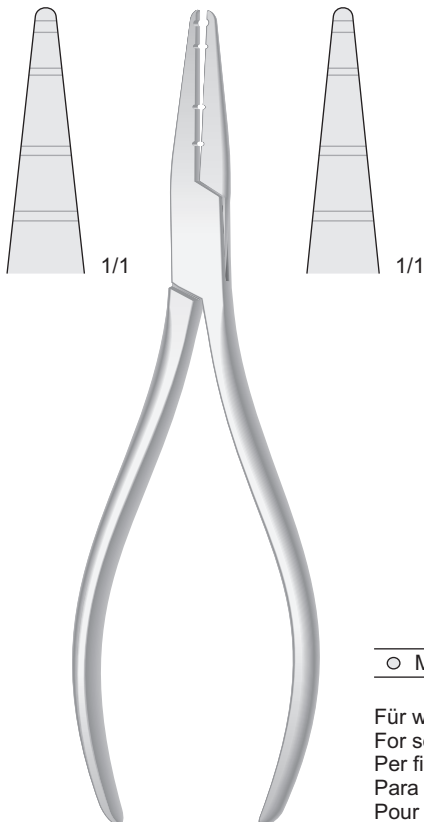

1/1

1/1

○ Max Ø 1.0 mm (.039")

Für weichen und harten Draht
For soft and hard Wire
Per filo leggero e duro
Para alambre blando y duro
Pour fil léger e dur

**ADERER
DP-95**
170 mm

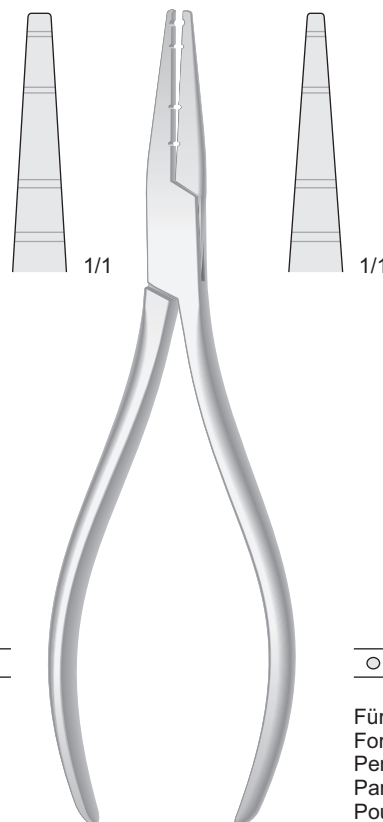

1/1

1/1

○ Max Ø 1.0 mm (.039")

Für weichen und harten Draht
For soft and hard Wire
Per filo leggero e duro
Para alambre blando y duro
Pour fil léger e dur

DP-97
165 mm

Konturenzangen

Contouring Pliers

Pinze per contornare

Alicates para contornear

Pinces à contours

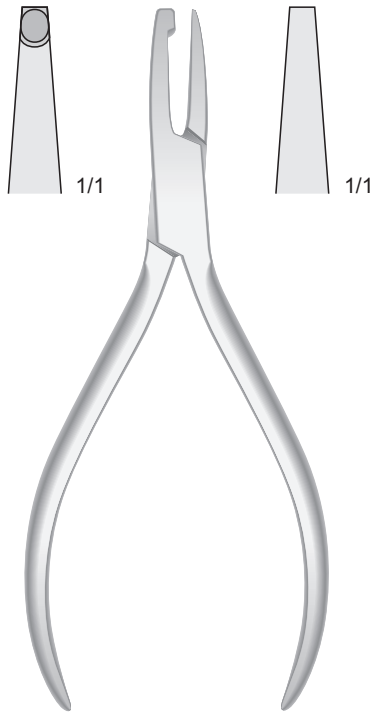

DP-49
140 mm



REYNOLDS
DP-33
130 mm



GORDON
DP-34
135 mm

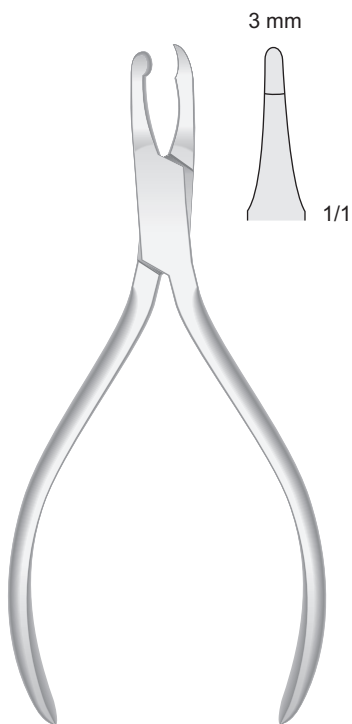

JOHNSON
DP-51
135 mm

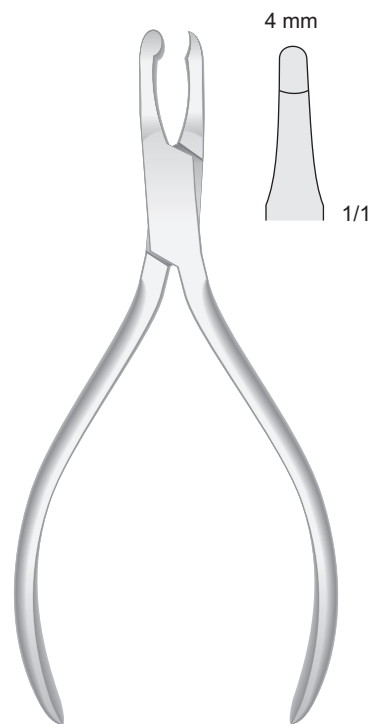

JOHNSON
DP-53
135 mm

Konturen Zangen

Contouring Pliers

Pinze per contornare

Alicates para contornear

Pinces à contours

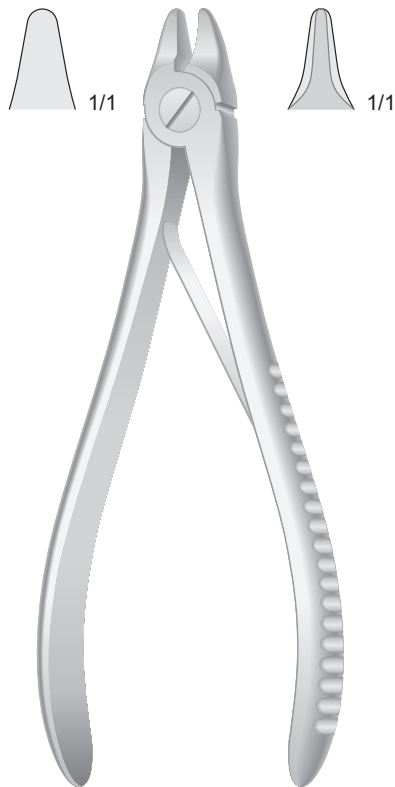

PEESO
DP-98
155 mm

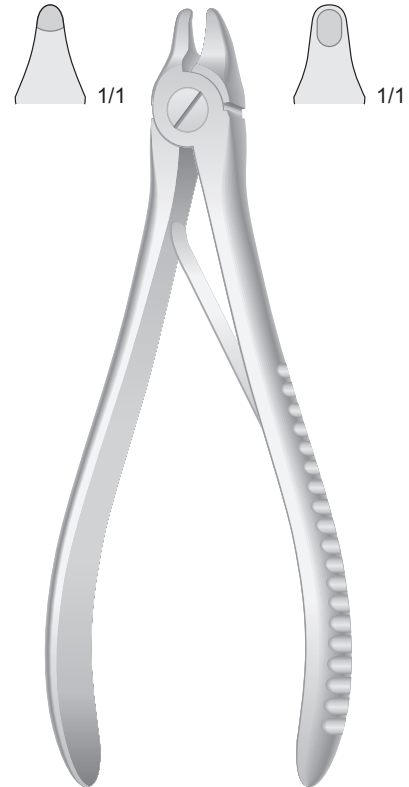

PEESO
DP-99
155 mm



LX-82
185 mm

○ Max Ø 1.6 mm (.063")

Für weichen und harten Draht
For soft and hard Wire
Per filo leggero e duro
Para alambre blando y duro
Pour fil léger e dur



TRIPLEX
DP-93
165 mm

Drahtbiegezangen

Wire bending Pliers

Pinze per piegare fili

Alicates para doblar alambres

Pinces à plier les fils

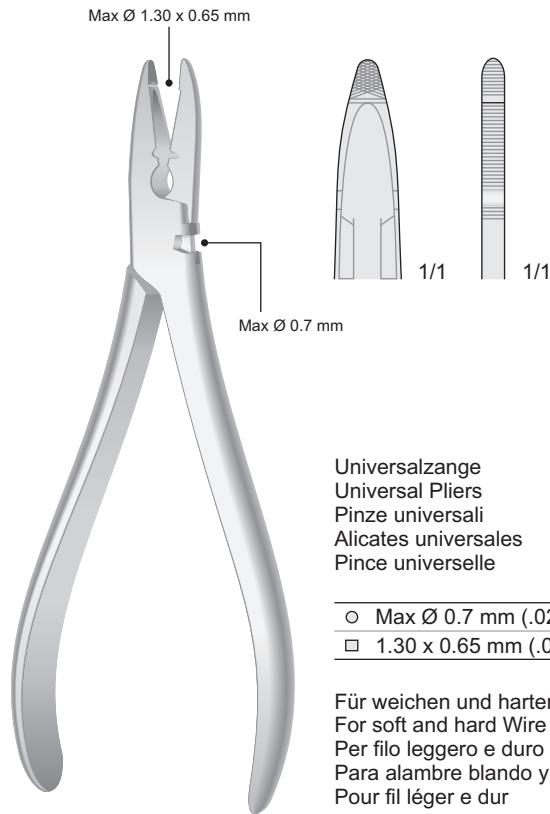

WALDSACHS
DP-84
150 mm

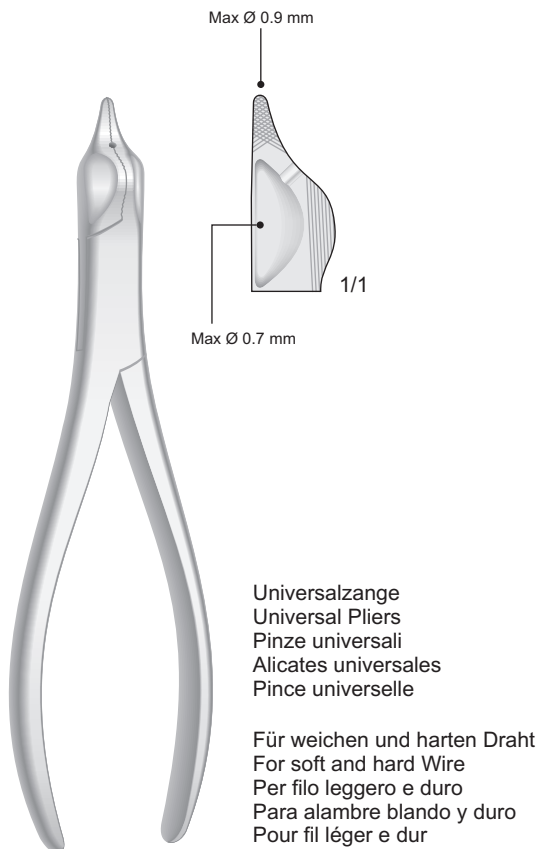

DP-71
150 mm

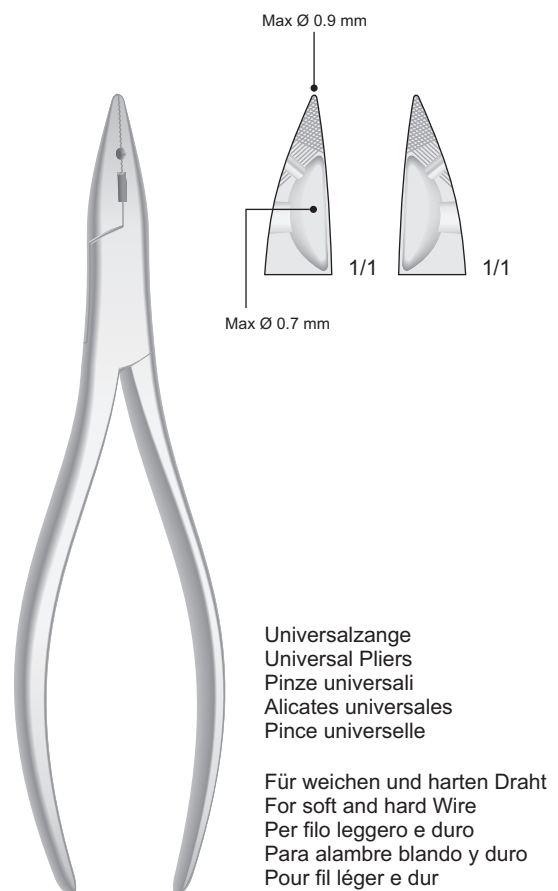

DP-75
160 mm

Drahtbiegezaugen

Wire bending Pliers

Pinze per piegare fili

Alicates para doblar alambres

Pinces à plier les fils

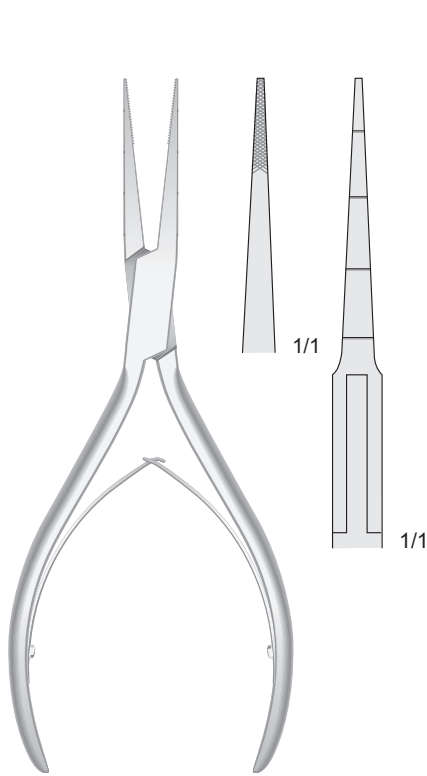

DP-96
150 mm

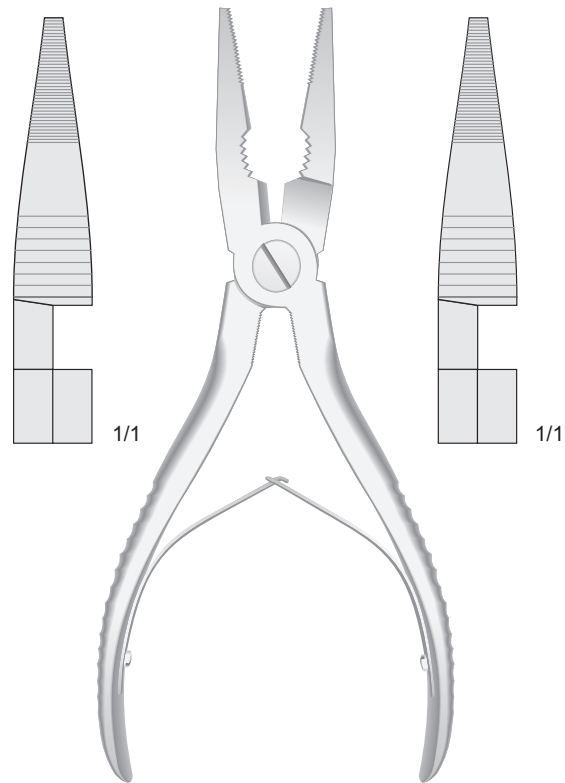

LX-135
175 mm

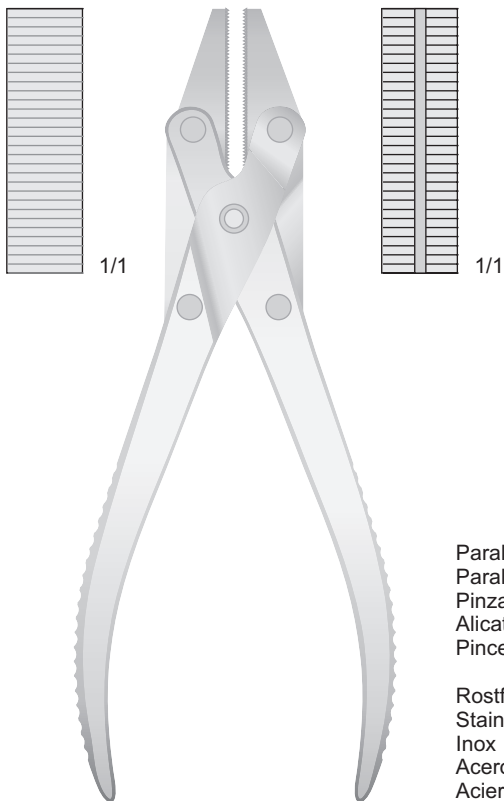

VH-25
185 mm

Parallel-Flachzange
Parallel Flat pliers
Pinza a branche parallele
Alicates planos
Pinces plates

Rostfrei
Stainless Steel
Inox
Acero
Acier

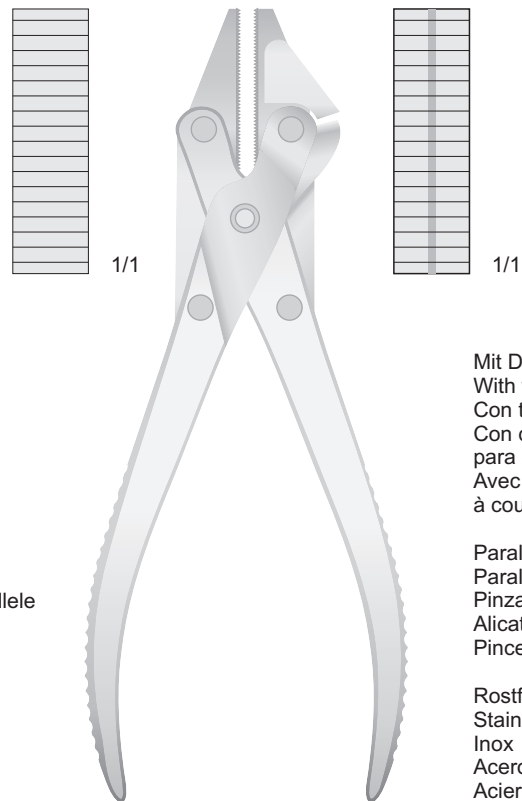

LX-80
185 mm

Mit Drahtschneider
With wire Cutter
Con tronchese
Con dispositivo
para cortar
Avec dispositif
à couper

Parallel-Flachzange
Parallel Flat pliers
Pinza a branche parallele
Alicates planos
Pinces plates

Rostfrei
Stainless Steel
Inox
Acero
Acier

Drahtschneidezangen Wire cutting pliers Tronchesi per fili metallici Alicates para cortar alambre Pincas à couper le fil

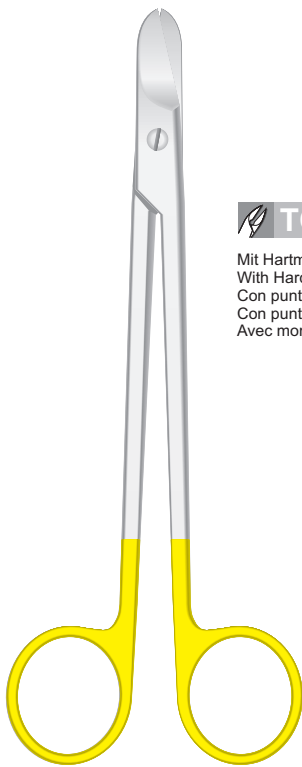

Mit Hartmetalleinsätzen
With Hard Metal Inserts
Con punte in metallo duro
Con puntas de metal duro
Avec mors en métal dur

SMITH
FG-160
160 mm

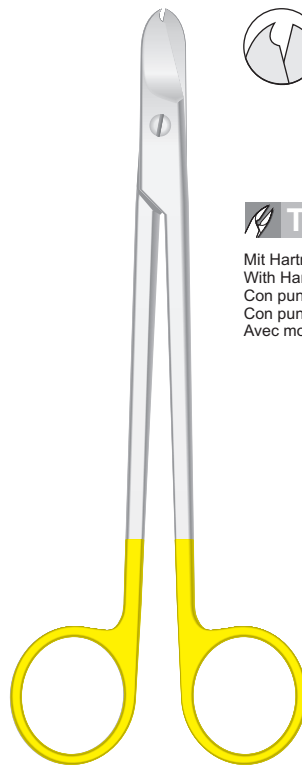

Mit Hartmetalleinsätzen
With Hard Metal Inserts
Con punte in metallo duro
Con puntas de metal duro
Avec mors en métal dur

SMITH
FG-161
160 mm



1/1



Mit Hartmetalleinsätzen
With Hard Metal Inserts
Con punte in metallo duro
Con puntas de metal duro
Avec mors en métal dur

PH-58
150 mm

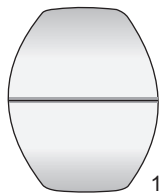
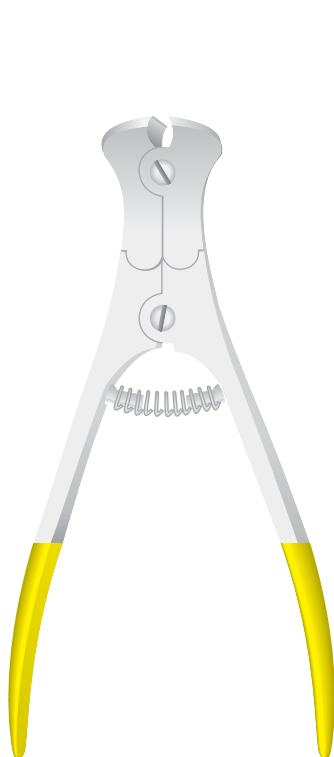

1/1



Mit Hartmetalleinsätzen
With Hard Metal Inserts
Con punte in metallo duro
Con puntas de metal duro
Avec mors en métal dur

○ Max Ø 2.0 mm (.078")

Für weichen Draht
For soft Wire
Per filo leggero
Para alambre blando
Pour fil léger

○ Max Ø 1.5 mm (.059")

Für harten Draht
For hard Wire
Per filo duro
Para alambre duro
Pour fil dur

LX-102
145 mm



1/1



Mit Hartmetalleinsätzen
With Hard Metal Inserts
Con punte in metallo duro
Con puntas de metal duro
Avec mors en métal dur

○ Max Ø 2.0 mm (.078")

Für weichen Draht
For soft Wire
Per filo leggero
Para alambre blando
Pour fil léger

○ Max Ø 1.5 mm (.059")

Für harten Draht
For hard Wire
Per filo duro
Para alambre duro
Pour fil dur

LX-103
170 mm

Scheren

Scissors

Forbici

Tijeras

Ciseaux

Scheren für dünne Stahl-und Edelmetallbleche - Scissors for thin steel and precious metal sheets
Forbici per lamine sottili di acciaio e metalli preziosi - Tijeras para láminas delgadas de acero y metales preciosos
Ciseaux pour couper les feuilles de métaux

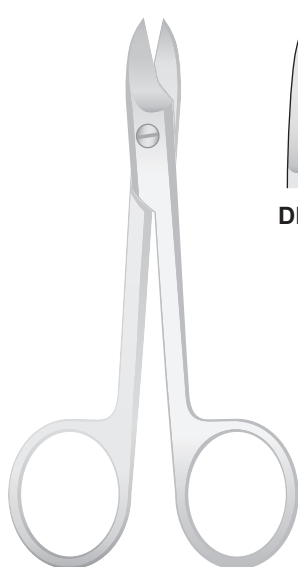

BEEBE
DP-91/DP-92
110 mm

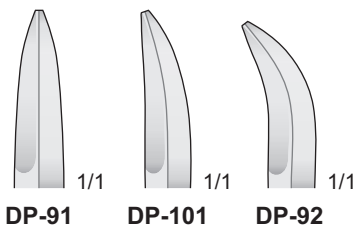

Spitz
Sharp
Acute
Agudas
Pointus



BEEBE
DP-102/DP-103
110 mm

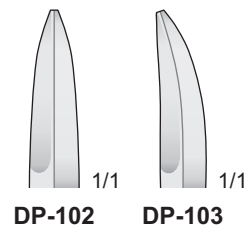

Stumpf
Blunt
Smusse
Romas
Mousses

Scheren für dünne Stahl-und Edelmetallbleche - Scissors for thin steel and precious metal sheets
Forbici per lamine sottili di acciaio e metalli preziosi - Tijeras para láminas delgadas de acero y metales preciosos
Ciseaux pour couper les feuilles de métaux

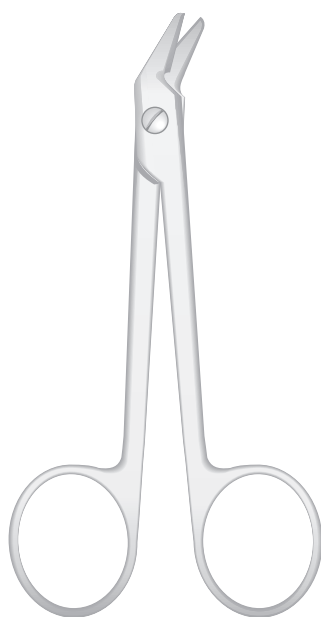

DP-90
120 mm

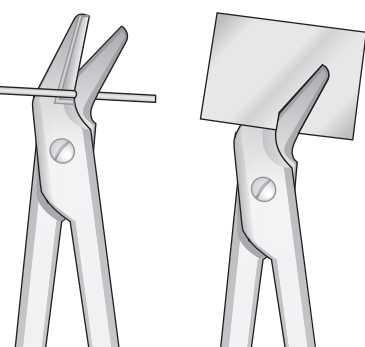

Draht-und Blechscherre gezahnt
Wire cutting scissor serrated
Forbice universale dentellata
Tijeras para cortar hilo
de acero dentadas
Coupe-fils dentelés

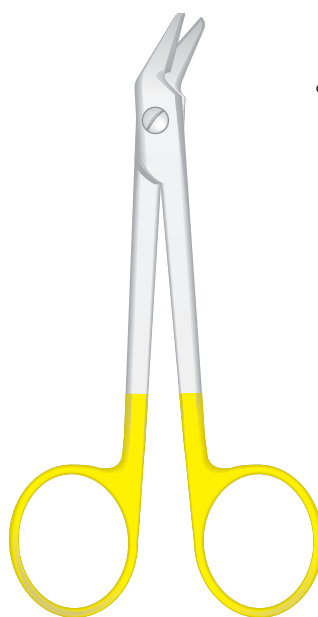

DP-120
120 mm

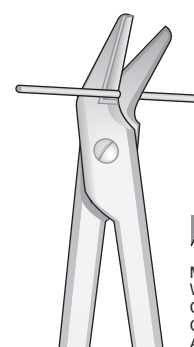

Mit Hartmetalleinsätzen
With Hard Metal Inserts
Con punte in metallo duro
Con puntas de metal duro
Avec mors en métal dur

○ Max Ø 1.2 mm (.048")

Für weichen Draht
For soft Wire
Per filo leggero
Para alambre blando
Pour fil léger

Separierzangen

Separating Pliers

Pinze tendielastici

Pinza estira-elásticos

Pince à separer

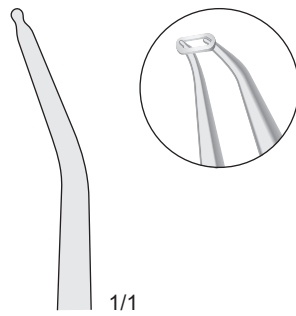

1/1

Separierzange, zum Einbringen
von Gummi-Separierligaturen
Separating forceps,
for inserting elastic separators
Pinze per legature
per separatori elastici
Pinza para ligaduras
estira elásticos
Pince à serrer les ligatures

DF-20
155 mm

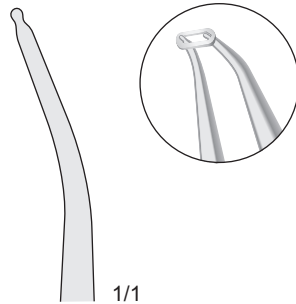
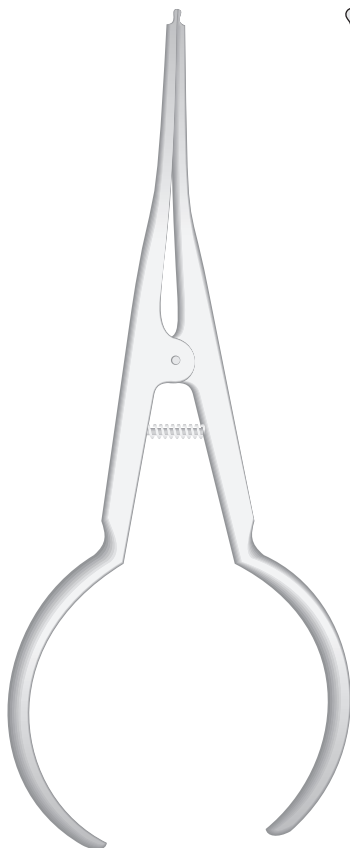

1/1

Separierzange, zum Einbringen
von Gummi-Separierligaturen
Separating forceps,
for inserting elastic separators
Pinze per legature
per separatori elastici
Pinza para ligaduras
estira elásticos
Pince à serrer les ligatures

DF-21
170 mm

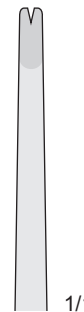
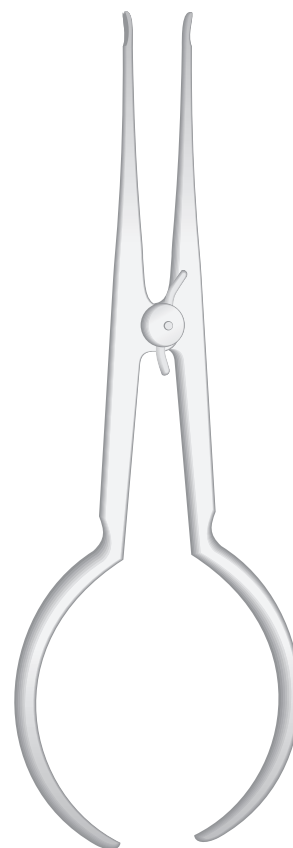

1/1

Ligaturenspannzange
Ligature Tying Plier
Pinza per legature
Pinza para ligaduras
Pince à serrer les ligatures

DF-50
170 mm

Ligatureinstrumente Ligating Instruments Strumenti per legature Instrumentos para ligaduras Instruments à ligature

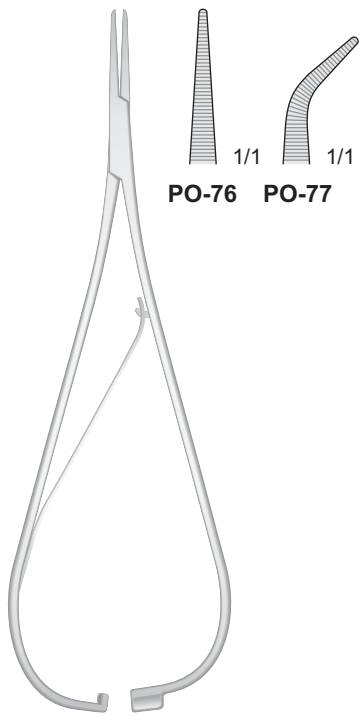

PO-76 PO-77

SMAHA
PO-76/PO-77
140 mm



Hole tip

SMAHA
PO-68
135 mm

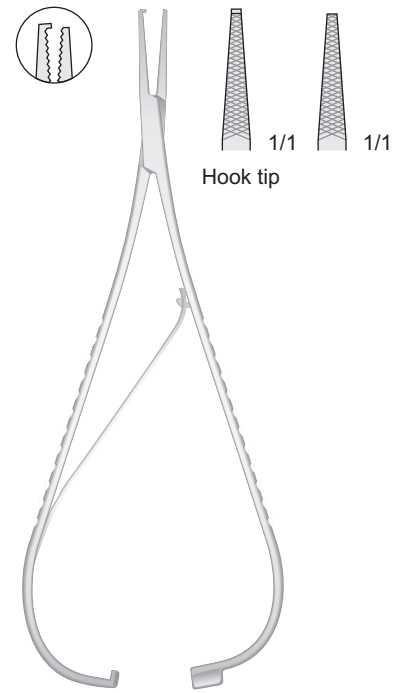

Hook tip

SMAHA
PO-69
135 mm

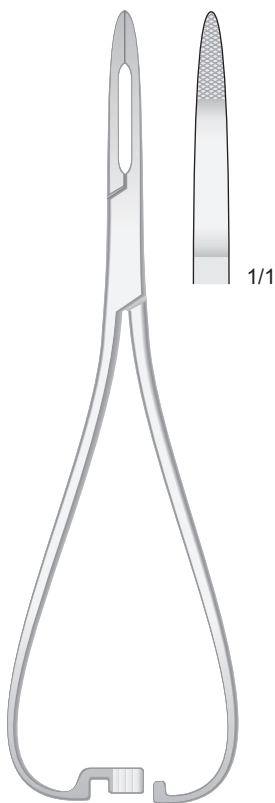

DP-86
165 mm

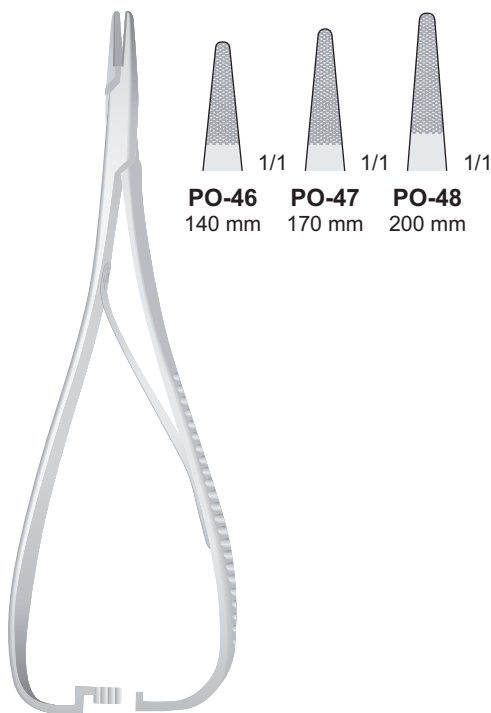

PO-46 PO-47 PO-48
140 mm 170 mm 200 mm

MATHIEU
PO-46/PO-48

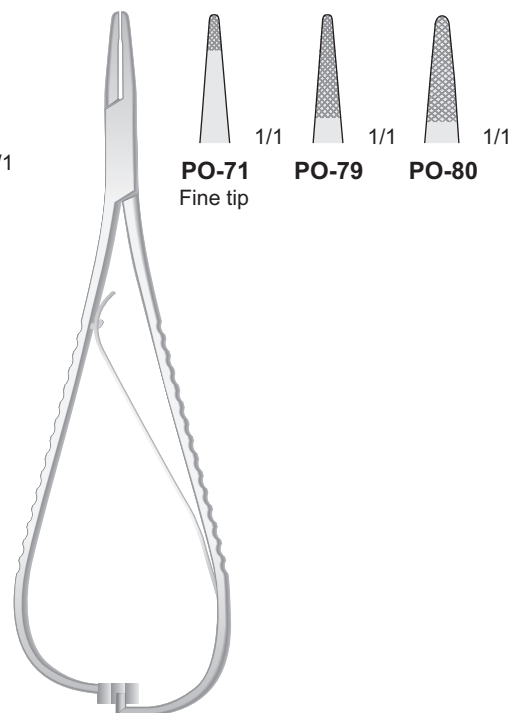

PO-71 PO-79 PO-80
Fine tip

MATHIEU
PO-71/PO-80
140 mm

Instrumente

Utility Instruments

Strumenti di utilità

Instrumentos

Instruments



In alluminio
leggero anodizzato

Bracketpositioner
Bracket Positioning Gauge
Posizionatore per
attacchi D.B. Posteriori
Posicionador de Brackets
Jauge à Brackets

DP-100
170 mm

Bandandrücker
Band Pusher
Spingibande
in acciaio inox
Empujador de bandas
Instruments pour
poser les bagues

Con punta dentellata



**MERSHON
DP-50**
140 mm

Scaler/Pusher, zum Setzen und Abnehmen
von Bändern sowie zum Entfernen
vom Zement und Kleberesten
Scaler/Pusher, for positioning and removing
bands and for removing cement
and adhesive residues
Strumento di utilità, ablatore di cemento
e posizionario di bande
Instrumentos para adaptar bandas

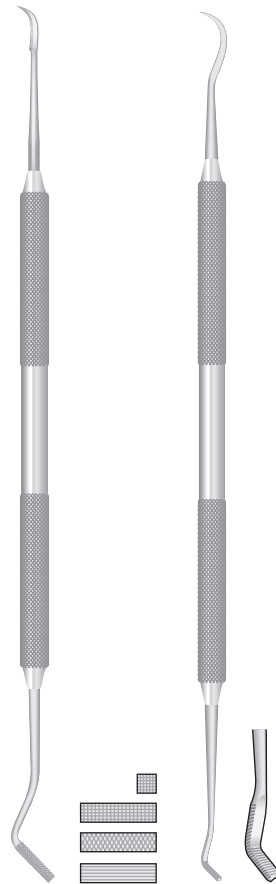

DP-54
175 mm

Direzionatori
di legature

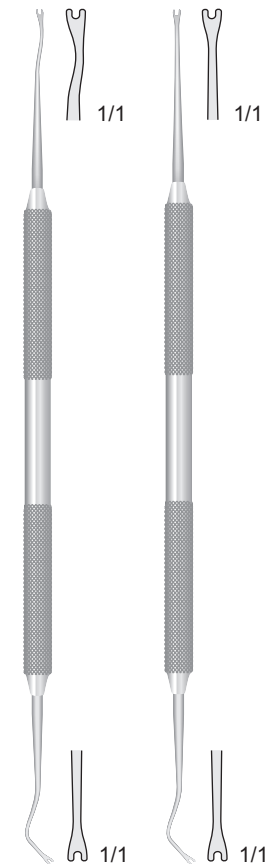

PF-1
170 mm

PF-2
170 mm

PF-3
160 mm

Ligaturen-Setzer
Twirl on instrument
Applicatore per
legature elastiche
Instrumentos para
aplicar las ligaduras
Instrument pour
appliquer
les ligatures

Ligatureinstrumente Ligating Instruments Strumenti per legature Instrumentos para ligaduras Instruments à ligature



PEAN-MURPHY
BF-22
130 mm

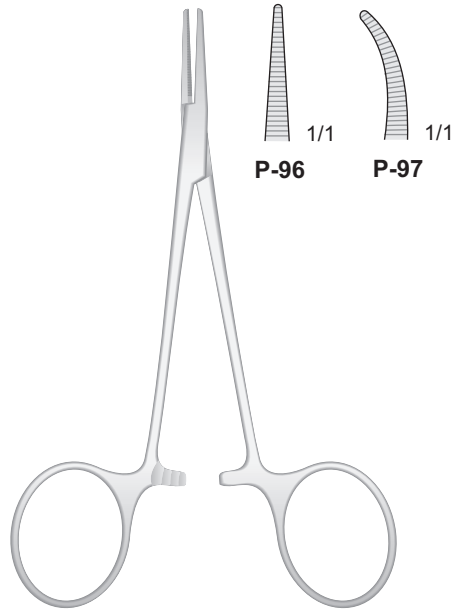

HALSTED-MOSQUITO
P-96/P-97
120 mm

Bracketset Pinzette
Forceps for positioning Brackets
Pinzette per riposizionare
gli attacchi diretti
(posizionamento dei Bracket)
Pinza para colocar Brackets
Précelle pour positionner
les Brackets



COLLEGE
150 mm



**MILLER
DR-78**
145 mm



DP-52
130 mm



DP-126
110 mm



DP-127
125 mm



DP-128
145 mm

Dental-Schieblehre für Praxis und Labor
Gauge Caliper for practice and laboratory
Calibri dentali per studio e laboratorio
Calibrador dental para el gabinete y el laboratorio
Gauge calibreur pour cabinet et laboratoire

Meßbereich: 0 - 10 mm
Measuring range: 0 - 10 mm
Campo di misura: 0 - 10 mm
Alcance de medición: 0 - 10 mm
Etendue de mesure: 0 - 10 mm



IWANSON
DP-720
100 mm



ZIELINSKY
DP-725
110 mm

Meßbereich: 0 - 100 mm
Measuring range: 0 - 100 mm
Campo di misura: 0 - 100 mm
Alcance de medición: 0 - 100 mm
Etendue de mesure: 0 - 100 mm

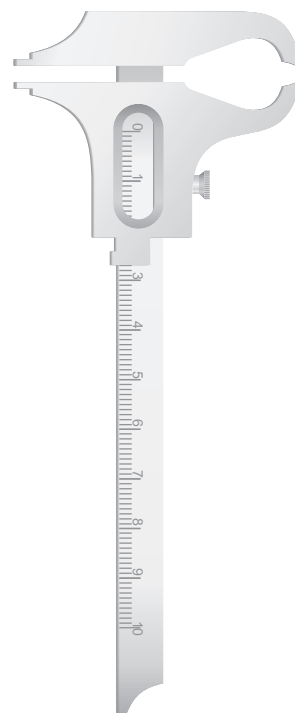

BOLEY
DP-730
140 mm

Inches - mm



LS-09
150 mm

Zubehör

Accessories

Accessori

Accesorios

Accessoires

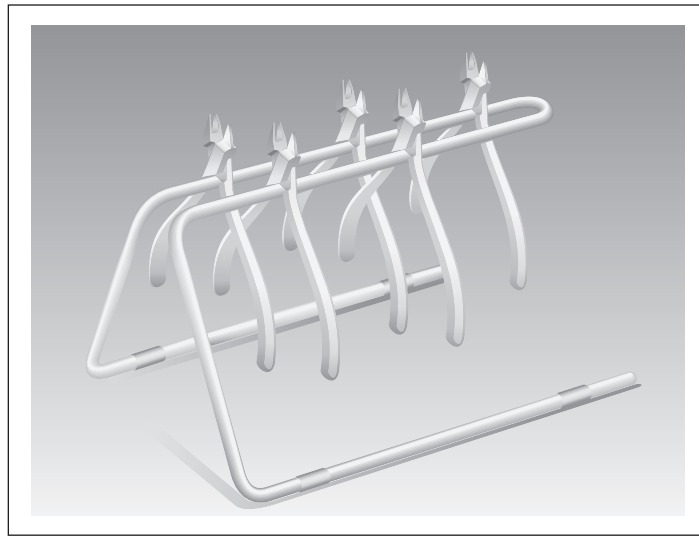

Zangenständer
Plier Stand
Supporto per pinze
Soportes para alicates
Supports de pinces

Rostfrei - Stainless Steel
Acciaio Inox - Acero - Acier

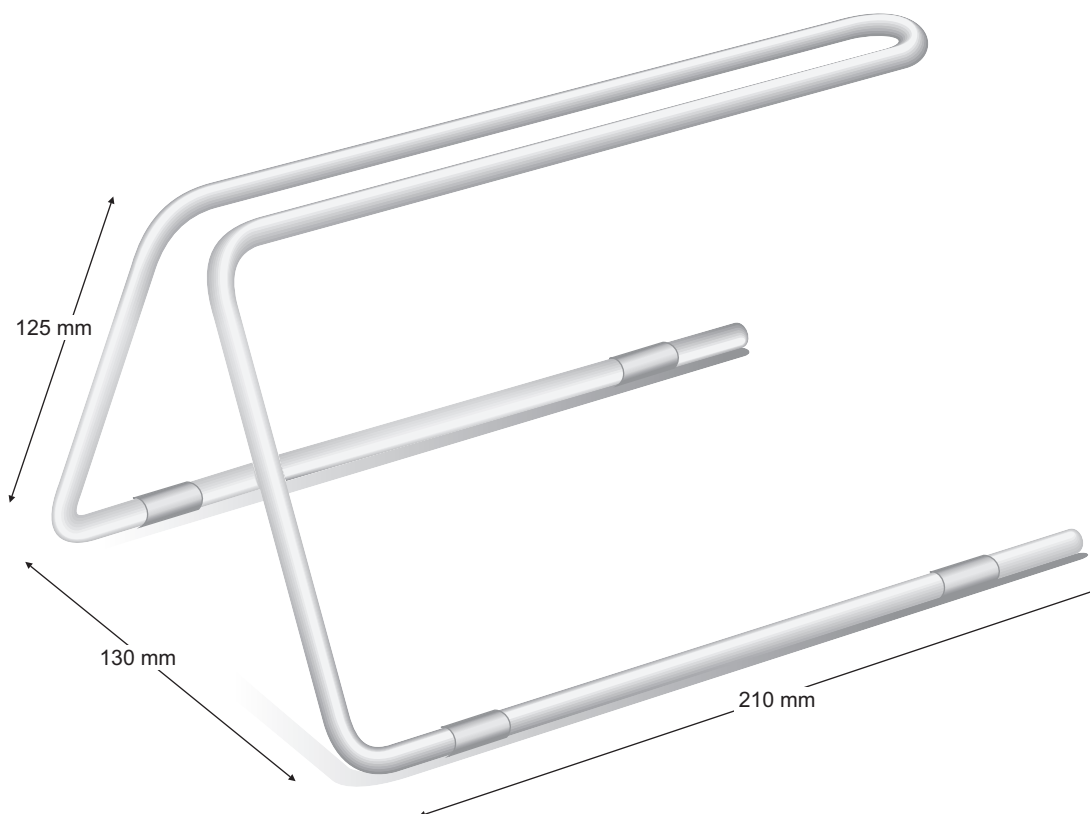

DP-140

Zubehör - Laboratorium
Accessories - Laboratory
Accessori - Laboratorio
Accesorios - Laboratorio
Accessoires - Laboratoire



BONTEMPI
CHIRURGISCHE INSTRUMENTE

Passion for excellence

Kroneninstrumente

Crown Instruments

Pinze per corone

Alicates para coronas

Pinces à couronnes



KERLING
DP-38A
145 mm

Kupferringabnehmezange
Copper ring removing Pliers
Pinza per togliere anelli di rame
Pinza para sacar anillos de cobre
Pince à enlever les bgues en cuivre



FURRER
DP-38
145 mm

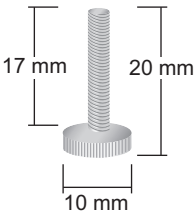

DP-38R
Schraube
Replacement Screw
Vite di ricambio
Tornillos de recambio
Rechange

Kupferringabnehmezange
Copper ring removing Pliers
Pinza per togliere anelli di rame
Pinza para sacar anillos de cobre
Pince à enlever les bgues en cuivre

Teleskopkronenzangen - Pliers for telescope crowns
Pinze per corone telescopiche - Alicates para coronas telescópicas
Pinces pour couronnes telescopes

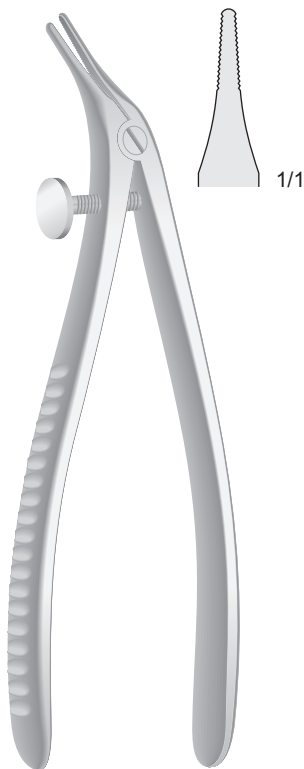

BÖHM
DP-28
150 mm

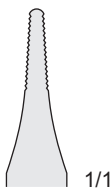

1/1

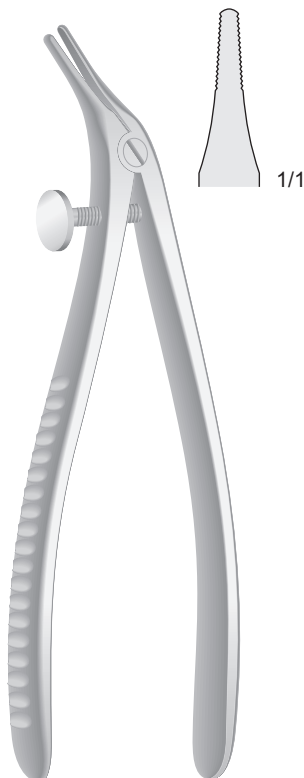

BÖHM
DP-29
150 mm

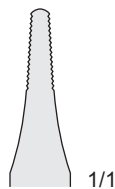

1/1



DP-24
120 mm



DP-24C
Schlüssel
Key
Chiavetta
Llave
Clé



DP-24R
Diamantierte Einsätze, paarweise
Diamond inserts, in pairs
Coppia di punte diamantate
Puntas diamantadas, a pares
Pointes diamantées, par paires

Instrumente
für Prothetik

Instruments
for prosthetics

Strumenti
per protesi

Instrumentos
para prótesis

Instruments
pour la prothèse

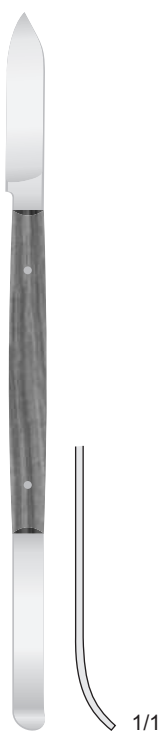

FAHNENSTOCK
CP

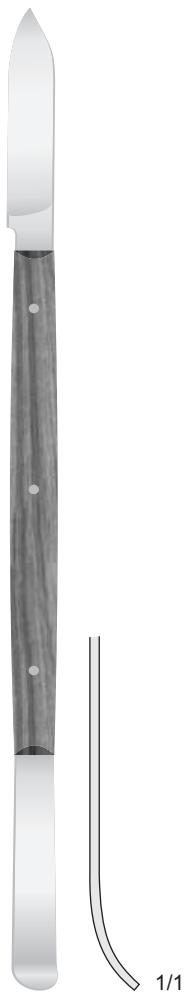

FAHNENSTOCK
CG



LESSMANN
CPL

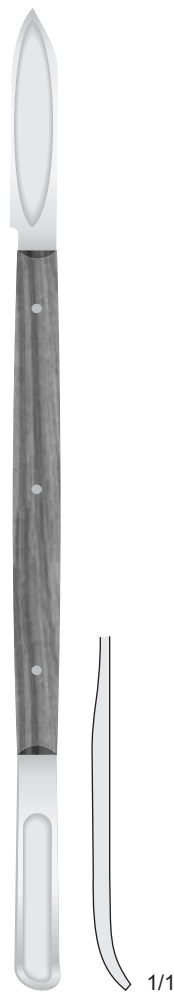

LESSMANN
CGL



CPS



CGS

Instrumente
für Prothetik

Instruments
for prosthetics

Strumenti
per protesi

Instrumentos
para prótesis

Instruments
pour la prothèse

Flexibel
Flexible
Flessibili
Flexibel

Spatola inox
Spatel inox



CM
175 mm



SA-1
200 mm



SA-2
200 mm



SA-3
200 mm



S18-8
185 mm

Instrumentenpflege

Maintenance of
instrumentsMantenimento dello
strumentarioMantenimiento del
instrumentalNettoyage
d'instrumentsOlio lubrificante per
strumenti chirurgici**RODHOIL**

Schmiermittel mit hoher Dichte. Es sichert den perfekten Gebrauch und die Leichtgängigkeit aller chirurgischen Instrumente. Man gibt es auf die Verbindungen und Gelenke und in alle beweglichen Teile, die Reibungen unterworfen sind.

RODHOIL

Lubricant to high density. It assures the perfect utility and fluency of all the surgical instruments. For apply in to loosens, join and in all the parts in subject movement subject to attrition.

RODHOIL

Lubrificante ad alta densità. Assicura la perfetta funzionalità e scorrevolezza di tutti gli strumenti chirurgici. Da applicare negli snodi, giunture e in tutte le parti in movimento soggette ad attrito.

**DB-OLR**
50 cc

Das wasserlösliche Schmiermittel verlängert die Lebensdauer von chirurgischen Instrumenten

Soluble lubricant extends useful life of surgical instruments
Lubrificante anticorrosivo e detergente per strumenti chirurgici
Lubrificante soluble en agua, so uso prolonga la duracion de los instrumentos quirurgicos
Lubrifiant soluble dans l'eau prolonge la vie des instruments chirurgicaux

CLEANLACT

Reinigungskonzentrat für chirurgische Instrumente. Es wirkt antibakteriell, nicht-ätzend und schmierig. Es garantiert die perfekte Erhaltung aller Instrumente aus Stahl, entfernt eventuelle Flecken, Ränder, und Bräunungen von Sterilisationen, Desinfektionen und Reinigungen mit hartem Wasser. Es sollte regelmäßig verwendet werden.

CLEANLACT

Product concentrated for surgical instruments. It explains an action anti-corrosive, antibacterium and lubricant. It guarantees the perfect maintenance of all the instruments in steel eliminating eventual stains and burnishes to sterilization, disinfection and to washings with hard waters. It used periodically.

CLEANLACT

Prodotto concentrato per strumenti chirurgici. Esplica un azione anticorrosiva batteriostatica e lubrificante. Garantisce il perfetto mantenimento di tutti gli strumenti in acciaio eliminando eventuali macchie, aloni e bruniture dovute a sterilizzazioni, disinfezioni e a lavaggi con acque dure. Va usato periodicamente.

**DB-50M**
500 cc**DB-1L**
1000 cc

Steril
Container

Sterilizing
containers

Contenitori per
sterilizzare

Contenedores
para esterilización

Containers
pour stérilizer

Schalen
Trays
Vassoi porta-strumenti
Bandejas
Bassins



VS-20 210 x 110 x 25 mm
VS-26 250 x 180 x 30 mm
VS-30 300 x 220 x 30 mm

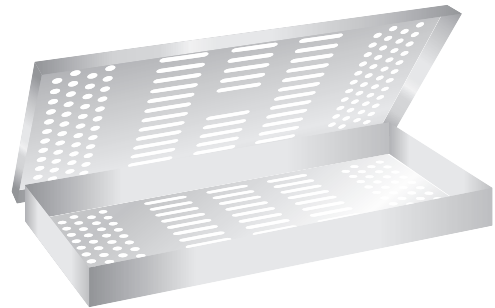

BS-41
275 x 130 x 25 mm

Rectengular drum
Cestelli rettangolari
Panier rectangulaire

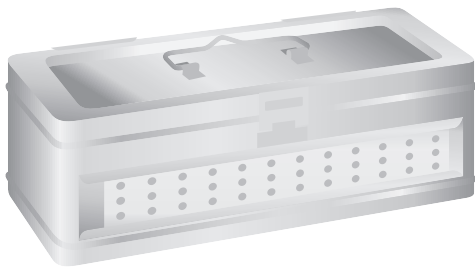

CS-32 300 x 150 x 60 mm
CS-33 300 x 150 x 90 mm
CS-34 300 x 150 x 180 mm

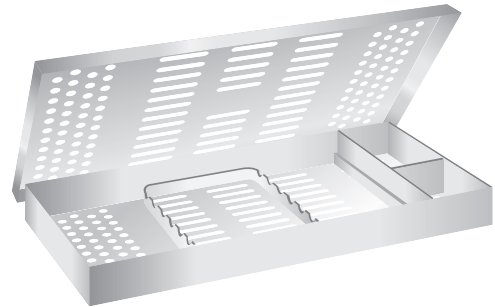

BS-40 275 x 130 x 25 mm Con griglia e scomparti
BS-42 285 x 190 x 25 mm Con griglia e scomparti

Silikonmatte
Matte en silicone
Tappeti in aghi di silicone
Tapete en agujas de silicona
Tapis en Silicone

Sterilisierbar
Autoclavable
Autoclavabili

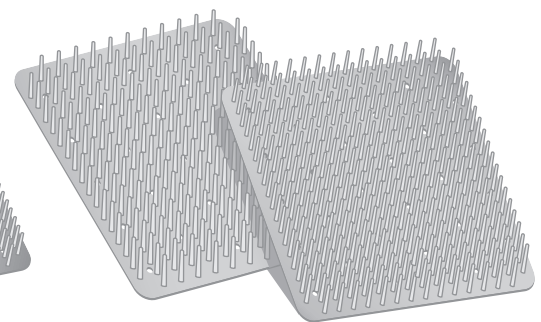
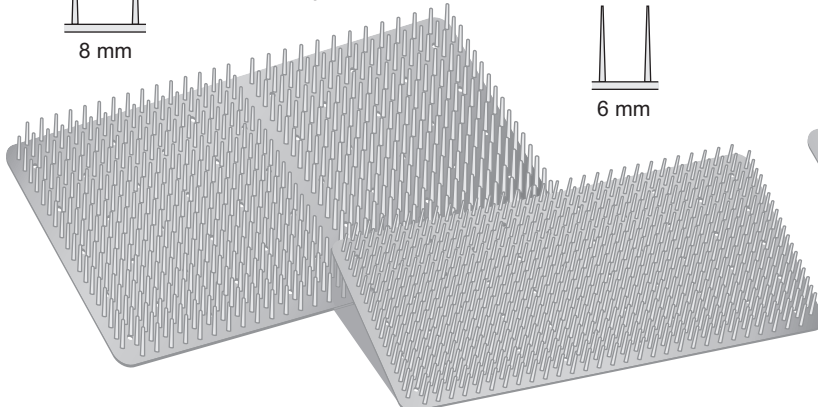
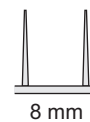
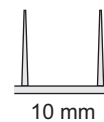
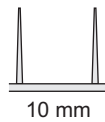
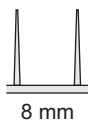

TS-104
270 x 180 mm

TS-103
260 x 120 mm

TS-102
135 x 180 mm

TS-101
135 x 180 mm

Alfabetisches Inhaltsverzeichnis
Alphabetical Index
Indice alfabetico
Indice alfabetico
Index alphabetique



BONTEMPI
CHIRURGISCHE INSTRUMENTE

Passion for excellence

Alphabetisches Inhaltsverzeichnis	Alphabetical Index	Indice alfabetico	Indice alfabetico	Index alphabétique
A				
ADAMS, Drahtbiegezeuge	17			
ADAMS-NANCE, Drahtbiegezeuge	31			
ADERER, Drahtbiegezeuge	16, 31, 32			
- Abnehmezeuge	24, 25			
ANDERSEN, Hohlkehlsangen	23			
ANGLE, Light Wire-Biegezeuge, Begg Typ	13			
- Schneidezangen Ligaturen-Cutter	3			
ANGLE-TWEED, Bogenbiegezeugen	18			
B				
BEEBE, Scheren	38			
BÖHM, Kroneninstrumente	47			
BOLEY, Meßinstrumente	43			
C				
COLLEGE, Zahnpinzette	42			
D				
DE LA ROSA, Konturenzangen	20			
F				
FAHNENSTOCK, Wachsmesser	48			
FISCHER, Flachzangen	26			
FURRER, Kroneninstrumente	47			
G				
GORDON, Konturenzangen	33			
GOSLEE, Flachzangen	26, 27			
H				
HALSTED-MOSQUITO, Ligaturen Instrumente	42			
HOLLOW-CHOP, Hohlkehlsangen	22			
HOW, Universalzange für die Multibandtechnik	15			
I				
IWANSON, Meßinstrumente	43			
J				
JARABAK, Drahtbiegezeuge	12			
- Hohlkehlsangen	23			
JOHNSON, Konturenzangen	33			
K				
KERLING, Kroneninstrumente	47			
L				
LANGENBECK, Drahtbiegezeuge	28			
LESSMANN, Wachsmesser	48			
M				
MALLOTHY, Drahtbiegezeuge	31			
MATHIEU, Ligaturen Instrumente	40			
McKELLOPS, Hohlkehlsangen	23			
MERSHON, Instrumente	41			
		MILLER, Artikulationspapierpinzette		42
N				
		NANCE, Schlaufen-Biegezeuge		20
		- Drahtbiegezeuge		30
O				
		OLIVER, Bandabnehmezeugen		25
		- Flachzangen		27
P				
		PEAN-MURPHY, Ligaturen Instrumente		42
		PEESO, Konturenzangen		34
		- Drahtbiegezeuge		28
R				
		REYNOLDS, Konturenzangen		33
S				
		SCHWARZ, Drahtbiegezeuge		30
		- Hohlkehlsangen mit Graduierung		22
		SHURE, Instrumente		41
		SMAHA, Ligaturen Instrumente		40
		SMITH, Drahtschneidezangen		37
T				
		TRIPLEX, Konturenzangen		34
		TWEED, Bogenbiegezeugen		18, 20, 21
W				
		WALDSACHS, Drahtbiegezeuge		35
		WEINGART, Universalzange		14
Y				
		YOUNG, Bogenbiegezeugen		21
Z				
		ZIELINSKY, Meßinstrumente		43

Alphabetisches Inhaltsverzeichnis	Alphabetical Index	Indice alfabetico	Indice alfabetico	Index alphabétique
A				
ADAMS , Wire Bending Pliers	17			
ADAMS-NANCE , Wire Bending Pliers	31			
ADERER , Wire Bending Pliers	16, 31, 32			
- Removing Pliers	24, 25			
ANDERSEN , Loop Forming Pliers, Gauge	23			
ANGLE , Begg-type light wire Bending Pliers	13			
- Ligature Cutters	3			
ANGLE-TWEED , Arch Forming Pliers	18			
B				
BEEBE , Scissors	38			
BÖHM , Crown Instruments	47			
BOLEY , Measuring Instruments	43			
C				
COLLEGE , Dressing Pliers	42			
D				
DE LA ROSA , Arch Forming Pliers	20			
F				
FAHNENSTOCK , Wax Knives	48			
FISCHER , Nose Flat Pliers	26			
FURRER , Crown Instruments	47			
G				
GORDON , Contouring Pliers	33			
GOSLEE , Nose Flat Pliers	26, 27			
H				
HALSTED-MOSQUITO , Ligating Instruments	42			
HOLLOW-CHOP , Loop Forming Pliers, Gauge	22			
HOW , Universal Forceps for Multiband Technique	15			
I				
IWANSON , Measuring Instruments	43			
J				
JARABAK , Begg-type light wire Bending Pliers	12			
- Loop Forming Pliers, Gauge	23			
JOHNSON , Contouring Pliers	33			
K				
KERLING , Crown Instruments	47			
L				
LANGENBECK , Wire Bending Pliers	28			
LESSMANN , Wax Knives	48			
M				
MALLOTHY , Wire Bending Pliers	31			
MATHIEU , Ligating Instruments	40			
McKELLOPS , Loop Forming Pliers, Gauge	23			
MERSHON , Utility Instruments	41			
		MILLER , Forceps for articulating paper		42
N				
		NANCE , Arch Forming Pliers		20
		- Wire Bending Pliers		30
O				
		OLIVER , Band Remover		25
		- Nose Flat Pliers		27
P				
		PEAN-MURPHY , Ligating Instruments		42
		PEESO , Contouring Pliers		34
		- Wire Bending Pliers		28
R				
		REYNOLDS , Contouring Pliers		33
S				
		SCHWARZ , Wire Bending Pliers		30
		- Bending Pliers with graduation		22
		SHURE , Utility Instruments		41
		SMAHA , Ligating Instruments		40
		SMITH , Wire Cutting Scissors		37
T				
		TRIPLEX , Contouring Pliers		34
		TWEED , Arch Forming Pliers		18, 20, 21
W				
		WALDSACHS , Wire Bending Pliers		35
		WEINGART , Universal Pliers		14
Y				
		YOUNG , Arch Forming Pliers		21
Z				
		ZIELINSKY , Measuring Instruments		43

Alphabetisches Inhaltsverzeichnis	Alphabetical Index	Indice alfabetico	Indice alfabetico	Index alphabétique
A				
ADAMS , Pinze per piegare fili	17			
ADAMS-NANCE , Pinze per piegare fili	31			
ADERER , Pinze per piegare fili	16, 31, 32			
- Pinze per rimozione	24, 25			
ANDERSEN , Pinze scanalate concave e convesse	23			
ANGLE , Pinze a becco di uccello	13			
- Tronchesi per legature	3			
ANGLE-TWEED , Pinze per formare archi	18			
B				
BEEBE , Forbici	38			
BÖHM , Pinza per corone	47			
BOLEY , Strumenti per misura	43			
C				
COLLEGE , Pinzetta di utilità	42			
D				
DE LA ROSA , Pinze per formare archi	20			
F				
FAHNENSTOCK , Coltelli per cera	48			
FISCHER , Pinze a punte piatte	26			
FURRER , Pinza per corone	47			
G				
GORDON , Pinze per contornare	33			
GOSLEE , Pinze a punte piatte	26, 27			
H				
HALSTED-MOSQUITO , Strumenti per legature	42			
HOLLOW-CHOP , Pinze scanalate concave e convesse	22			
HOW , Pinze di utilità per archi	15			
I				
IWANSON , Strumenti per misura	43			
J				
JARABAK , Pinze a becco di uccello	12			
- Pinze scanalate concave e convesse	23			
JOHNSON , Pinze per contornare	33			
K				
KERLING , Pinza per corone	47			
L				
LANGENBECK , Pinze per piegare fili	28			
LESSMANN , Coltelli per cera	48			
M				
MALLOTHY , Pinze per piegare fili	31			
MATHIEU , Strumenti per legature	40			
McKELLOPS , Pinze scanalate concave e convesse	23			
MERSHON , Strumenti di utilità	41			
		MILLER , Pinzetta per carta articolazione		42
N				
		NANCE , Pinza per formare archi		20
		- Pinze per piegare fili		30
O				
		OLIVER , Pinza per rimuovere le bande		25
		- Pinze a punte piatte		27
P				
		PEAN-MURPHY , Strumenti per legature		42
		PEESO , Pinza per contornare		34
		- Pinze per piegare fili		28
R				
		REYNOLDS , Pinze per contornare		33
S				
		SCHWARZ , Pinze per piegare fili		30
		- Pinze scanalate con gradazione		22
		SHURE , Strumento di utilità		41
		SMAHA , Strumenti per legature		40
		SMITH , Forbici per fili metallici		37
T				
		TRIPLEX , Pinze per contornare		34
		TWEED , Pinze per formare archi		18, 20, 21
W				
		WALDSACHS , Pinze per piegare fili		35
		WEINGART , Pinze universali		14
Y				
		YOUNG , Pinze per formare archi		21
Z				
		ZIELINSKY , Strumenti per misura		43

Alphabetisches Inhaltsverzeichnis	Alphabetical Index	Indice alfabetico	Indice alfabetico	Index alphabétique
A				
ADAMS, Alicates para doblar alambre	17			
ADAMS-NANCE, Alicates para doblar alambre	31			
ADERER, Alicates para doblar alambre	16, 31, 32			
- Alicates para remover	24, 25			
ANDERSEN, Alicates acanalados	23			
ANGLE, Alicates para doblar, tipo Begg	13			
- Alicates para cortar ligaduras	3			
ANGLE-TWEED, Alicates para doblar arcos	18			
B				
BEEBE, Tijeras	38			
BÖHM, Alicates para coronas	47			
BOLEY, Instrumentos para medir	43			
C				
COLLEGE, Pinza para curaciones	42			
D				
DE LA ROSA, Alicates para doblar arcos	20			
F				
FAHNENSTOCK, Cuchillos para cera	48			
FISCHER, Alicates planos	26			
FURRER, Alicates para coronas	47			
G				
GORDON, Alicates para contornear	33			
GOSLEE, Alicates planos	26, 27			
H				
HALSTED-MOSQUITO, Instrumentos para ligaduras	42			
HOLLOW-CHOP, Alicates acanalados	22			
HOW, Alicates para doblar arcos	15			
I				
IWANSON, Instrumentos para medir	43			
J				
JARABAK, Alicates para doblar, tipo Begg	12			
- Alicates acanalados	23			
JOHNSON, Alicates para contornear	33			
K				
KERLING, Alicates para coronas	47			
L				
LANGENBECK, Alicates para doblar alambre	28			
LESSMANN, Cuchillos para cera	48			
M				
MALLOTHY, Alicates para doblar alambre	31			
MATHIEU, Instrumentos para ligaduras	40			
McKELLOPS, Alicates acanalados	23			
MERSHON, Instrumentos	41			
		MILLER, Pinza para papel de articular		42
N				
		NANCE, Alicates para doblar arcos		20
		- Alicates para doblar alambre		30
O				
		OLIVER, Alicates para remover bandas		25
		- Alicates planos		27
P				
		PEAN-MURPHY, Instrumentos para ligaduras		42
		PEESO, Alicates para contornear		34
		- Alicates para doblar alambre		28
R				
		REYNOLDS, Alicates para contornear		33
S				
		SCHWARZ, Alicates para doblar alambre		30
		- Alicate de media caña con graduación		22
		SHURE, Instrumentos		41
		SMAHA, Instrumentos para ligaduras		40
		SMITH, Alicates para cortar alambre		37
T				
		TRIPLEX, Alicates para contornear		34
		TWEED, Alicates para doblar arcos		18, 20, 21
W				
		WALDSACHS, Alicates para doblar alambre		35
		WEINGART, Alicates Universales		14
Y				
		YOUNG, Alicates para doblar arcos		21
Z				
		ZIELINSKY, Instrumentos para medir		43

Alphabetisches Inhaltsverzeichnis	Alphabetical Index	Indice alfabetico	Indice alfabetico	Index alphabétique
A				
ADAMS , Pincers à pliers les fils	17			
ADAMS-NANCE , Pincers à pliers les fils	31			
ADERER , Pincers à pliers les fils	16, 31, 32			
- Pincers à ôter enlever	24, 25			
ANDERSEN , Pincers a mors concave et rond	23			
ANGLE , Pincers à courber type Begg	13			
- Pincers coupe-ligatures	3			
ANGLE-TWEED , Pincers à courber les arcs	18			
B				
BEEBE , Ciseaux	38			
BÖHM , Pincers à couronnes	47			
BOLEY , Instruments à mesurer	43			
C				
COLLEGE , Précelle pour coton	42			
D				
DE LA ROSA , Pincers à courber les arcs	20			
F				
FAHNENSTOCK , Couteaux à cire	48			
FISCHER , Pincers à mors plats	26			
FURRER , Pincers à couronnes	47			
G				
GORDON , Pincers à contours	33			
GOSLEE , Pincers à mors plats	26, 27			
H				
HALSTED-MOSQUITO , Instruments à ligature	42			
HOLLOW-CHOP , Pincers à mors concave et rond	22			
HOW , Pincers à courbes les arcs	15			
I				
IWANSON , Instruments à mesurer	43			
J				
JARABAK , Pincers à courber type Begg	12			
- Pincers à mors concave et rond	23			
JOHNSON , Pincers à contours	33			
K				
KERLING , Pincers à couronnes	47			
L				
LANGENBECK , Pincers à pliers les fils	28			
LESSMANN , Couteaux à cire	48			
M				
MALLOTHY , Pincers à pliers les fils	31			
MATHIEU , Instruments à ligature	40			
McKELLOPS , Pincers à mors concave et rond	23			
MERSHON , Instruments	41			
		MILLER , Pince pour papier à articuler		42
N				
		NANCE , Pincers à courber les arcs		20
		- Pincers à pliers les fils		30
O				
		OLIVER , Pincers à détacher les bagues		25
		- Pincers à mors plats		27
P				
		PEAN-MURPHY , Instruments à ligature		42
		PEESO , Pincers à contours		34
		- Pincers à pliers les fils		28
R				
		REYNOLDS , Pincers à contours		33
S				
		SCHWARZ , Pincers à pliers les fils		30
		- Pincers à plier moyenne fine		22
		SHURE , Instruments		41
		SMAHA , Instruments à ligature		40
		SMITH , Ciseaux à couper le fil		37
T				
		TRIPLEX , Pincers à contours		34
		TWEED , Pincers à courbes les arcs		18, 20, 21
W				
		WALDSACHS , Pincers à pliers les fils		35
		WEINGART , Pince universelle		14
Y				
		YOUNG , Pincers à courbes les arcs		21
Z				
		ZIELINSKY , Instruments à mesurer		43

Nummernverzeichnis
Alphanumerical Index
Indice alfanumerico
Indice alfanumerico
Index alphanumerique



BONTEMPI
CHIRURGISCHE INSTRUMENTE

Passion for excellence

Nummernverzeichnis		Alphanumerical Index		Indice alfanumerico		Indice alfanumerico		Index alphanumerique	
Articolo	Pagina	Articolo	Pagina	Articolo	Pagina	Articolo	Pagina	Articolo	Pagina
BF-22	42	DP-28	47	DP-89	32	LX-DS2	7		
		DP-29	47	DP-90	38	LX-DS3	8		
BS-40	51	DP-30	26	DP-91	38	LX-DS4	7		
BS-41	51	DP-31	11	DP-92	38	LX-DS5	8		
BS-42	51	DP-32	26	DP-93	34	LX-DS6	7		
		DP-33	33	DP-95	32	LX-DS6L	8		
CG	48	DP-34	33	DP-96	36				
CGL	48	DP-35	24	DP-97	32	P-96	42		
CGS	48	DP-36	25	DP-98	34	P-97	42		
CM	49	DP-36T	25	DP-99	34				
CP	48	DP-36TC	25	DP-100	41	PF-1	41		
CPL	48	DP-37	25	DP-101	38	PF-2	41		
CPS	48	DP-38	47	DP-102	38	PF-3	41		
		DP-38A	47	DP-103	38				
COLLEGE	42	DP-38R	47	DP-106	12	PH-58	37		
		DP-39	27	DP-107	19				
CS-32	51	DP-40	16	DP-108	12	PO-46	40		
CS-33	51	DP-41	31	DP-110	19	PO-47	40		
CS-34	51	DP-42	31	DP-112	14	PO-48	40		
		DP-43	17	DP-113	14	PO-68	40		
DB-1L	50	DP-43TC	17	DP-115	20	PO-69	40		
DB-50M	50	DP-44	16	DP-116	30	PO-71	40		
DB-OLR	50	DP-45	30	DP-117	24	PO-76	40		
		DP-46	31	DP-118	30	PO-77	40		
DF-20	39	DP-47	17	DP-119	30	PO-79	40		
DF-21	39	DP-48	24	DP-120	38	PO-80	40		
DF-50	39	DP-49	33	DP-123	16				
		DP-50	41	DP-124	41	S18-8	49		
DP-01	13	DP-51	33	DP-126	42				
DP-1R	25	DP-52	42	DP-127	42	SA-1	49		
DP-01TC	13	DP-53	33	DP-128	42	SA-2	49		
DP-02	13	DP-54	41	DP-140	44	SA-3	49		
DP-2R	25	DP-55	11	DP-141A	19				
DP-03	14	DP-56	24	DP-141B	19	VH-25	36		
DP-3R	25	DP-57	11	DP-143	18				
DP-03S	14	DP-58	22	DP-145	17	VS-20	51		
DP-04	26	DP-59	22	DP-720	43	VS-26	51		
DP-4R	25	DP-60	18	DP-725	43	VS-30	51		
DP-05	15	DP-61	22	DP-730	43				
DP-05L	15	DP-62	23			TS-101	51		
DP-05S	15	DP-63	12	DR-78	42	TS-102	51		
DP-06	15	DP-63A	23			TS-103	51		
DP-06L	15	DP-64	23	FG-160	37	TS-104	51		
DP-06S	15	DP-65	22	FG-161	37				
DP-07	13	DP-66	23						
DP-08	26	DP-67	22	LS-09	43				
DP-08TC	26	DP-68	22						
DP-10	26	DP-69	22	LX-80	36				
DP-11	26	DP-69A	22	LX-82	34				
DP-12	26	DP-70	20	LX-86	5				
DP-13	26	DP-70A	20	LX-88	6				
DP-14	26	DP-71	35	LX-89	6				
DP-15	27	DP-72	21	LX-90	4				
DP-15L	27	DP-72R	21	LX-91	4				
DP-16	26	DP-73	21	LX-92	4				
DP-17	26	DP-74	21	LX-92TC	4				
DP-18	27	DP-75	35	LX-93	5				
DP-18A	27	DP-76	18	LX-94	6				
DP-19	26	DP-76TC	18	LX-95	3				
DP-20	26	DP-77	32	LX-95TC	3				
DP-21	28	DP-78	24	LX-96	3				
DP-22	28	DP-79	20	LX-96TC	3				
DP-22M	28	DP-79A	20	LX-97	5				
DP-23	28	DP-81	20	LX-98	5				
DP-24	47	DP-82	30	LX-99	6				
DP-24C	47	DP-84	35	LX-102	37				
DP-24R	47	DP-86	40	LX-103	37				
DP-25	16	DP-87	29	LX-135	36				
DP-26	12	DP-87A	29						
DP-27	27	DP-88	29	LX-DS1	7				



Bontempi

SURGICAL INSTRUMENTS
PORTUGAL

Passion for Excellence

Rua Poeta de Bocage, nº 15-F, Letra J
1600-240 Lisboa
T: + 351 210 968 925
F: + 351 210 968 925

info@bontempiportugal.pt
www.bontempiportugal.pt