



# Bontempi

SURGICAL INSTRUMENTS  
PORTUGAL

Passion for Excellence



Mund-kiefer und Gesichts-chirurgie  
Oral Maxillo-Facial surgery  
Chirurgia Maxillofacciale  
Cirugia Oral y Maxilofacial  
Chirurgie Oralee et Maxilla-faciale



Mund-kiefer und Gesichts-chirurgie  
Oral Maxillo-Facial surgery  
Chirurgia Maxillofacciale  
Cirugia Oral y Maxilofacial  
Chirurgie Oralee et Maxilla-faciale

**BONTEMPI**  
CHIRURGISCHE INSTRUMENTE

Passion for excellence



Messinstrumente  
Measuring instruments  
Strumenti per misura  
Instrumentos para medir  
Instruments à mesurer

Messzirkel  
Calipers  
Compassi  
Compases  
Compas

Meßbereich: 0 - 20 mm  
Measuring range: 0 - 20 mm  
Campo di misura: 0 - 20 mm  
Alcance de medición: 0 - 20 mm  
Etendue de mesure: 0 - 20 mm

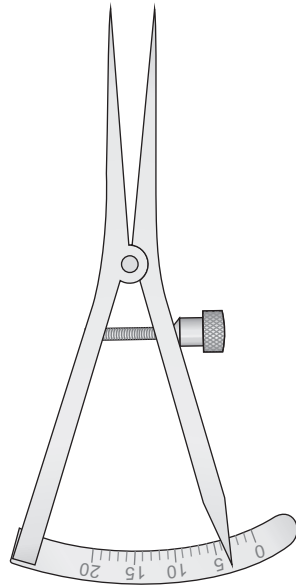

**CASTROVIEJO  
OR-17**  
90 mm

Meßbereich: 0 - 20 mm  
Measuring range: 0 - 20 mm  
Campo di misura: 0 - 20 mm  
Alcance de medición: 0 - 20 mm  
Etendue de mesure: 0 - 20 mm

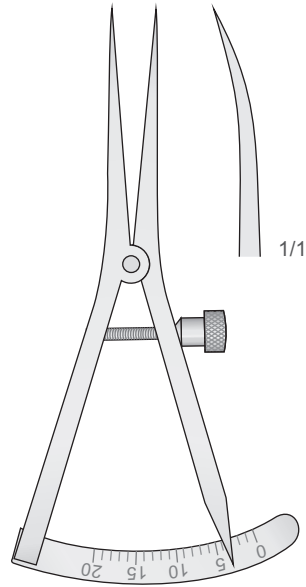

**CASTROVIEJO  
OR-19**  
90 mm

Meßbereich: 0 - 80 mm  
Measuring range: 0 - 80 mm  
Campo di misura: 0 - 80 mm  
Alcance de medición: 0 - 80 mm  
Etendue de mesure: 0 - 80 mm



**OR-40**  
125 mm

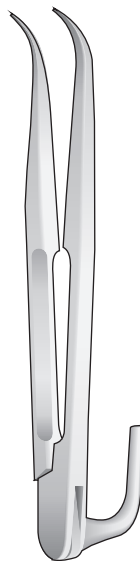

**ZIELINSKY  
DP-725**  
110 mm

0,5 mm



**LS-08**  
100 mm

0,5 mm



**LS-09**  
200 mm

Meßbereich: 0 - 40 mm  
Measuring range: 0 - 40 mm  
Campo di misura: 0 - 40 mm  
Alcance de medición: 0 - 40 mm  
Etendue de mesure: 0 - 40 mm

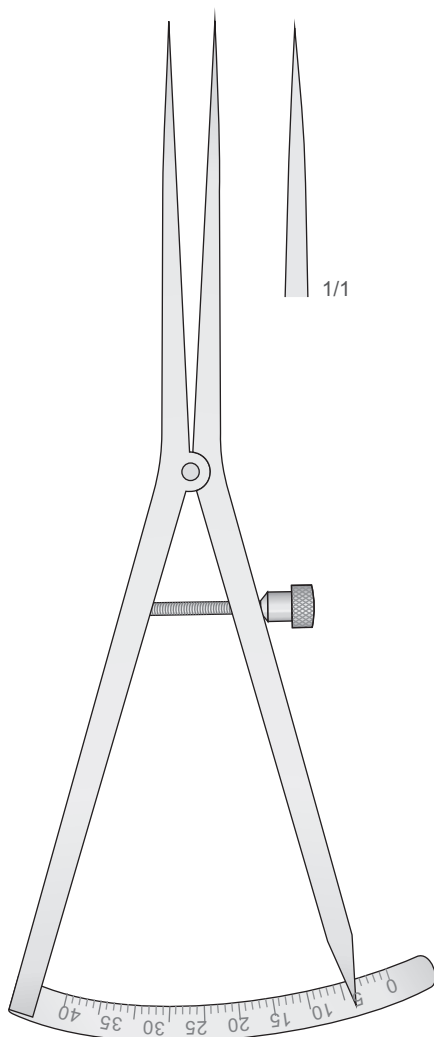

**CASTROVIEJO**  
**OR-12**  
170 mm

Meßbereich: 0 - 40 mm  
Measuring range: 0 - 40 mm  
Campo di misura: 0 - 40 mm  
Alcance de medición: 0 - 40 mm  
Etendue de mesure: 0 - 40 mm

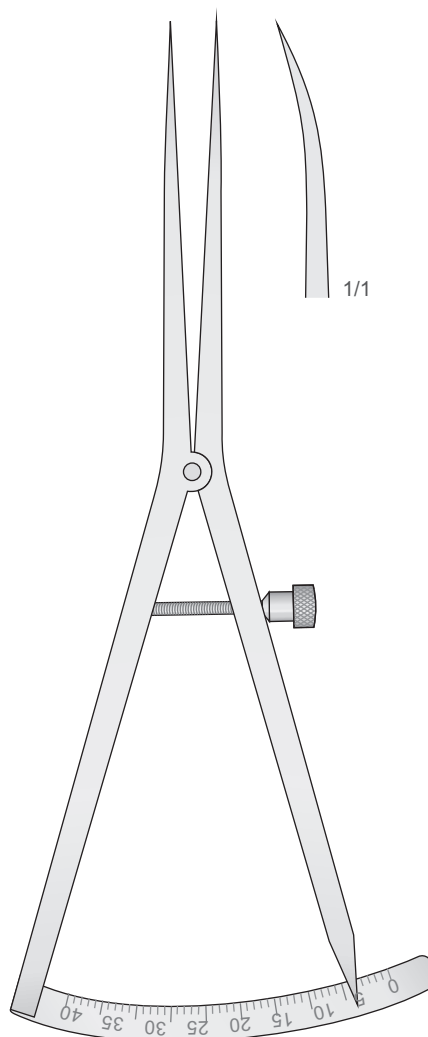

**CASTROVIEJO**  
**OR-14**  
170 mm

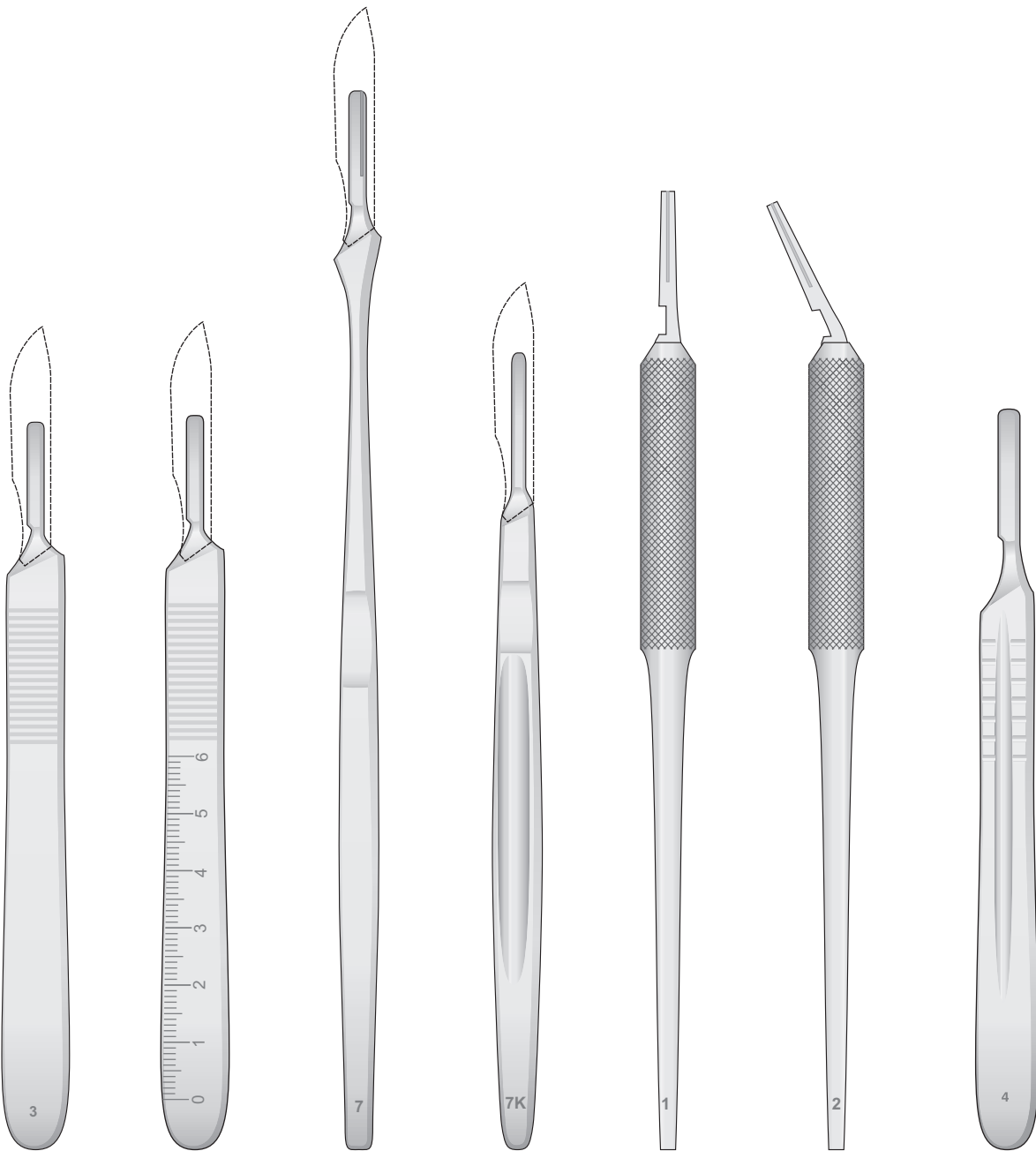

**MA-B3**  
Fig. 3

**MA-B3M**  
Fig. 3M

**MA-B7**  
Fig. 7

**MA-B7K**  
Fig. 7K

**MA-B1**  
Fig. 5

**MA-B2**  
Fig. 5A

**MA-B4**  
Fig. 4

Scalpellklingen, steril  
Scalpel blades, steril  
Lame da bisturi sterili  
Hojas de bisturios esteriles  
Lames de bistouris steriles

Packungen à 100  
Packages of 100 ea  
Scatole da 100 pezzi  
Cajas de 100 c/u  
Boîtes de 100 pièces

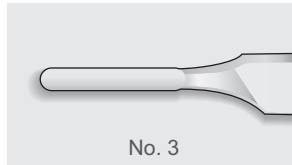

**LB-10**  
Fig. 10



**LB-11**  
Fig. 11

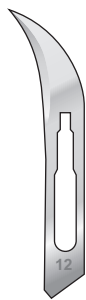

**LB-12**  
Fig. 12



**LB-12D**  
Fig. 12D



**LB-13**  
Fig. 13



**LB-15**  
Fig. 15



**LB-15A**  
Fig. 15A



**LB-15C**  
Fig. 15C

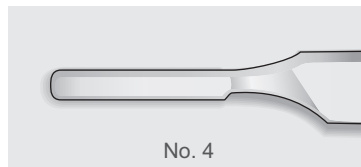

**LB-18**  
Fig. 18



**LB-20**  
Fig. 20



**LB-21**  
Fig. 21



**LB-22**  
Fig. 22



**LB-23**  
Fig. 23



**LB-24**  
Fig. 24



**LB-25**  
Fig. 25



**LB-36**  
Fig. 36



Skalpellgriffe, Mikro Scalpellklingen  
Scalpel handles, Micro Scalpel blades  
Manici per bisturi, Micro lame per bisturi  
Mangos de bisturias, Micro hojas de bisturias  
Manches de bistouris, Micro lames de bistouris

Skalpellgriffe für Mikro-Klingen  
Scalpel handles for Micro blades  
Manici per micro lame  
Mangos de bisturí para micro hojas  
Manches de bistouris pour micro lames

Micro-Klingen  
Micro blades  
Micro lame  
Micro hojas  
Micro lames

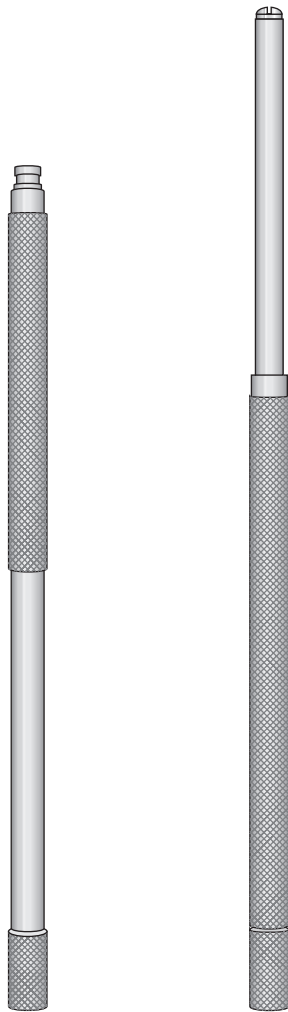

**BB-46**  
135 mm

**BB-48**  
155 mm



**LB-361**



**LB-362**



**LB-364**

Packung mit 10 Stück  
Package with 10 units  
Confezione 10 pezzi  
Paquete con 10 unidades  
Boîte avec 10 lames



**LB-365**



**LB-367**



**LB-368**

Packung mit 10 Stück  
Package with 10 units  
Confezione 10 pezzi  
Paquete con 10 unidades  
Boîte avec 10 lames



**LB-363**

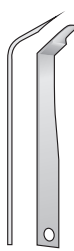

**LB-366**



**LB-369**

Packung mit 1 Stück  
Package with 1 unit  
Confezione 1 pezzo  
Paquete con 1 unidade  
Boîte avec 1 lame

Dermatome komplett mit 1 auswechselbarer Klinge und 2 Spannplatten  
Dermatome complete with 1 interchangeable blade and 2 skin plates  
Dermatomo con una lama intercambiabile, completo di 2 placche per stendere la pelle  
Dermatomo completo, con 1 hoja intercambiabile y 2 placas para extender la piel  
Dermatome avec 1 lame interchangeable et 2 plaques pour tendre la peau

Einstellbar von 0,1 bis 3,0 mm  
Adjustable from 0,1 to 3,0 mm  
Regolabile da 0,1 a 3,0 mm  
Regulable de 0,1 hasta 3,0 mm  
Réglable en épaisseur de 0,1 à 3,0 mm

Einstellbar von 0,1 bis 4,0 mm  
Adjustable from 0,1 to 4,0 mm  
Regolabile da 0,1 a 4,0 mm  
Regulable de 0,1 hasta 4,0 mm  
Réglable en épaisseur de 0,1 à 4,0 mm

Für handelsübliche Rasierklingen  
For usual razor blades  
Per lamette da barba standard  
Para hojas de afeitar usuales  
Pour lames de rasoir modèle standard

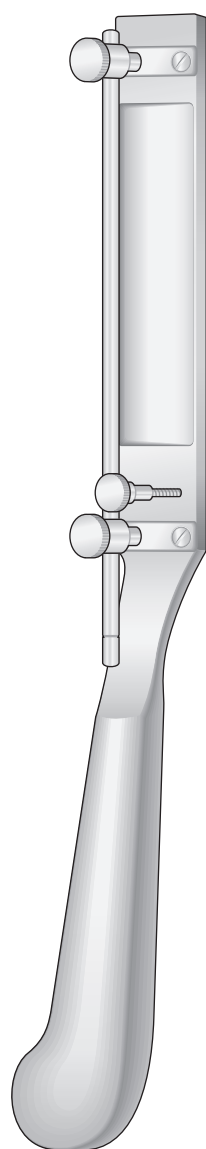

**SCHINK  
DE-13**  
300 mm

Ersatzklinge, allein  
Spare Blade only  
Lama di ricambio sola  
Hoja de repuesto suelto  
Lame de rechange, seule



**SCHINK  
DE-14**  
102 mm

Spannplatte  
Skin Fixing Plate  
Placca per stendere la pelle  
Placa para extender la piel  
Plaque pour tendre la peau



**SCHINK  
DE-10**



**SILVER  
DE-11**  
190 mm

Ersatzklinge, allein  
Spare Blade only  
Lama di ricambio sola  
Hoja de repuesto suelto  
Lame de rechange, seule

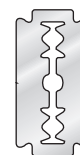

**SILVER  
DE-12**  
43 mm

Hautstanzen  
Tissue punches  
Mucotomi Punches  
Punches para cortar tejidos  
Punches à couper le tissu

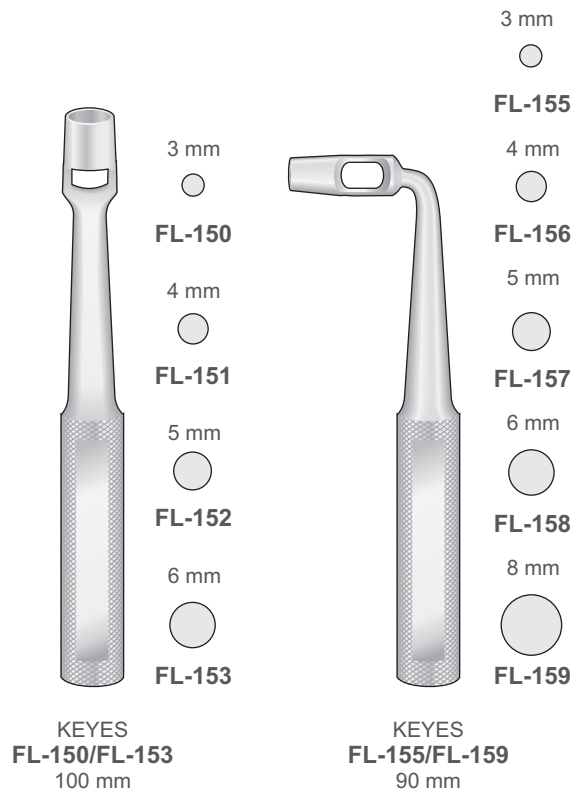

Zungen Spatel, Zungendrucker  
Tongue Spatulas, Tongue depressors  
Spatole per lingua, Abbassalingua  
Espátulas bucales, Bajalengua  
Spatules à langue, Abaisse-langues

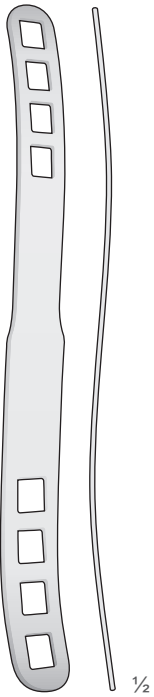

**BRUENINGS**  
**OM-04**  
190 mm

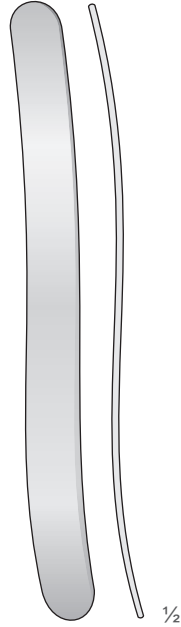

**OM-05**  
145 mm

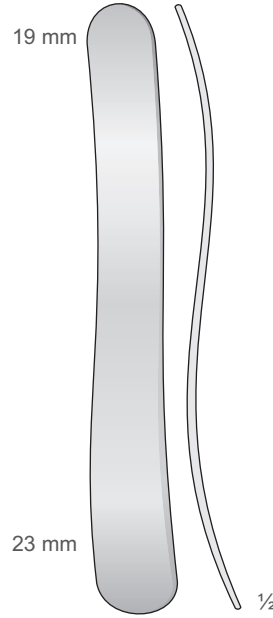

**KROENIG**  
**OM-16**  
150 mm

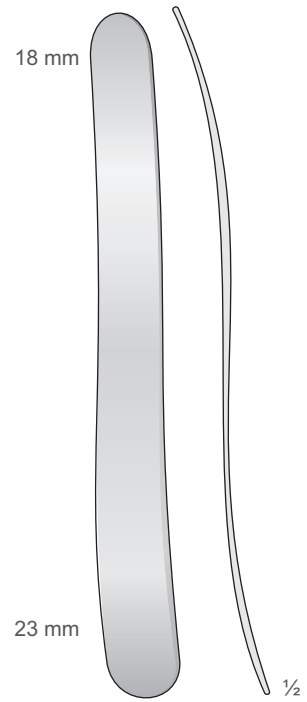

**BUCHWALD**  
**OM-18**  
180 mm

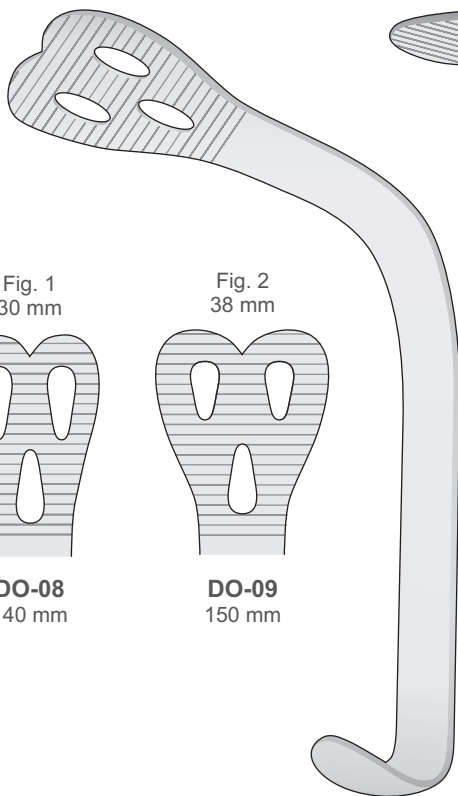

Fig. 1  
30 mm

Fig. 2  
38 mm

**DO-08**  
140 mm

**DO-09**  
150 mm

**WIEDER**  
**DO-08/DO-09**

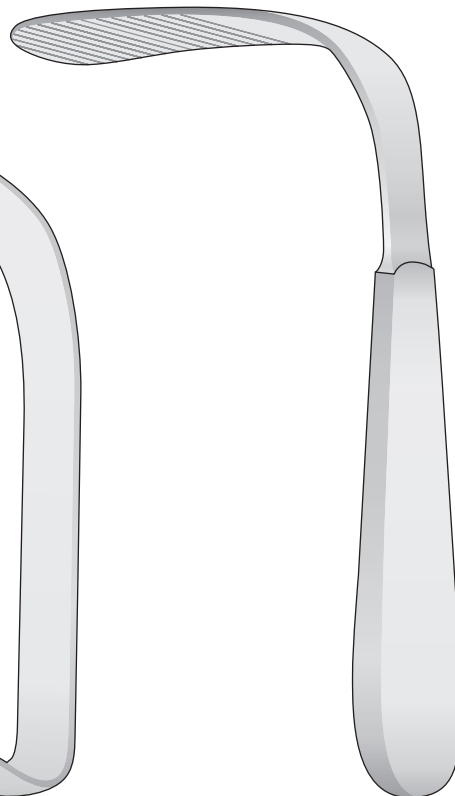

**TOBOLD**  
**OM-08**  
145 mm

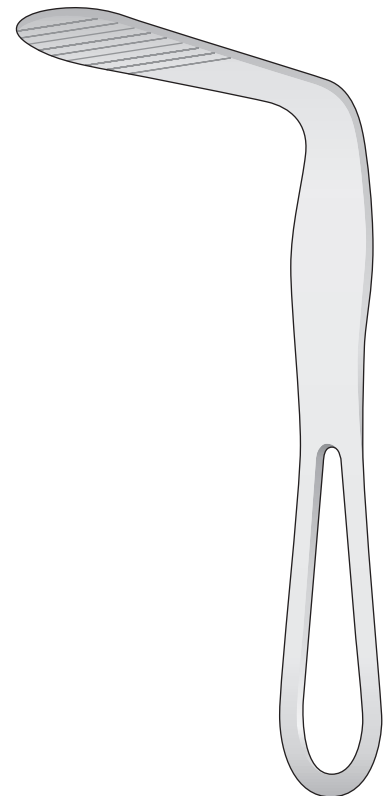

**HARTMANN**  
**OM-06**  
150 mm

Lippen- und Wangenhalter  
Lip and Cheek Retractors  
Divaricatori di labbra e guance  
Separadores de labios y mejillas  
Ecarteurs de lèvres et de joues

22 mm

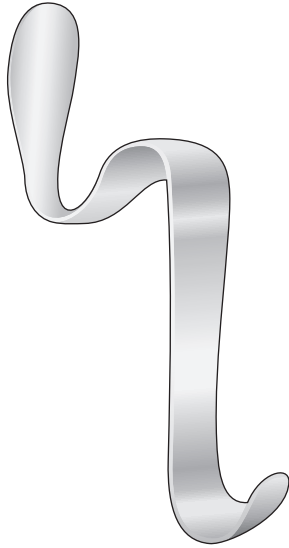

**BISHOP  
OM-61**  
130 mm



**MINNESOTA  
OM-55**  
140 mm

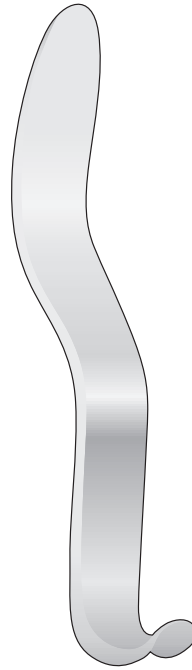

**CAWOOD-MINNESOTA  
OM-66**  
160 mm

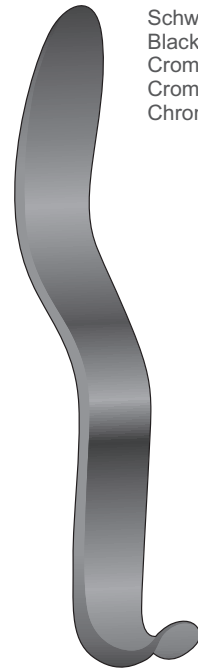

**CAWOOD-MINNESOTA  
OM-66B**  
160 mm

Schwarz Verchromt  
Black anodized  
Cromato nero  
Cromado en negro  
Chromé noir

Malleable Retractors, Protectors

Schwarz Verchromt  
Black Chromium Plated  
Cromate nere

18



22

**OM-80**  
200 mm

14



16

**OM-81**  
200 mm

18

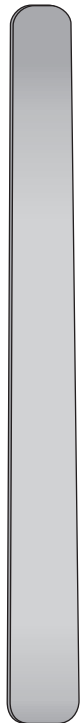

22

**OM-87**  
200 mm

14

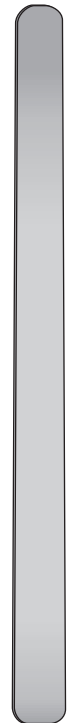

16

**OM-88**  
200 mm

17



25

**TUFFIER  
OM-99**  
200 mm



**OM-98**  
195 mm

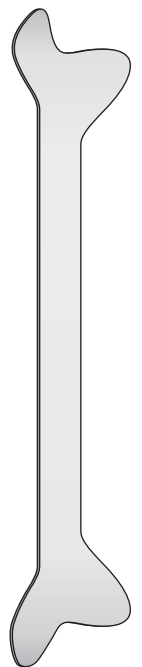

**OM-100**  
180 mm

Lippen- und Wangenhalter  
Lip and Cheek Retractors  
Divaricatori di labbra e guance  
Separadores de labios y mejillas  
Ecarteurs de lèvres et de joues

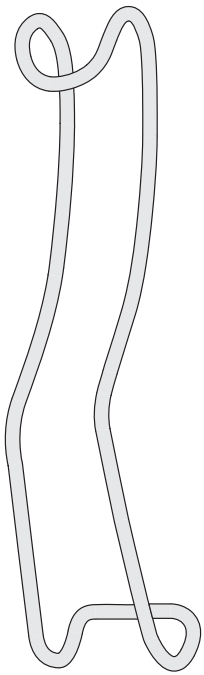

STERNBERG  
**OM-50**  
160 mm

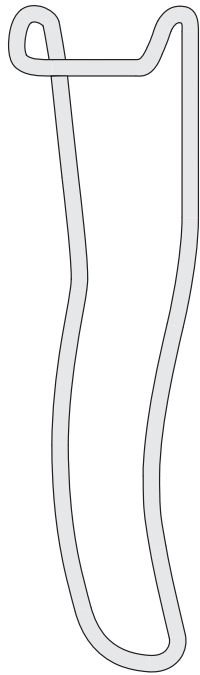

STERNBERG  
**OM-52**  
160 mm

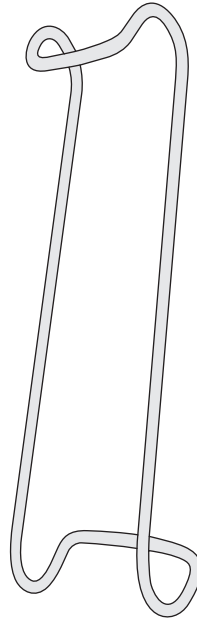

COLUMBIA  
**OM-67**  
140 mm

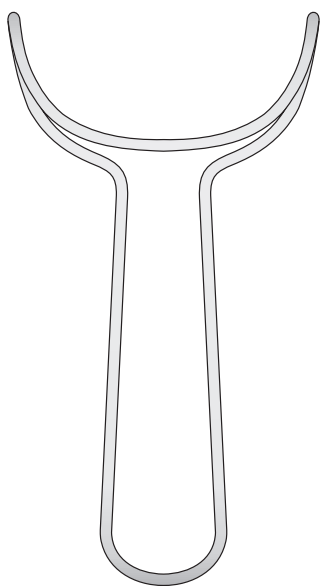

**OM-90**  
150 mm

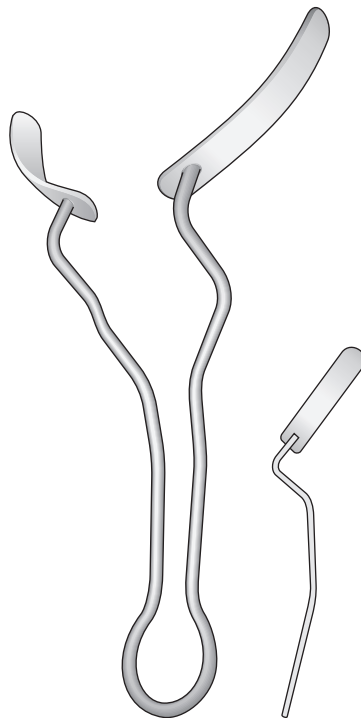

MATY  
**OM-97**  
170 mm

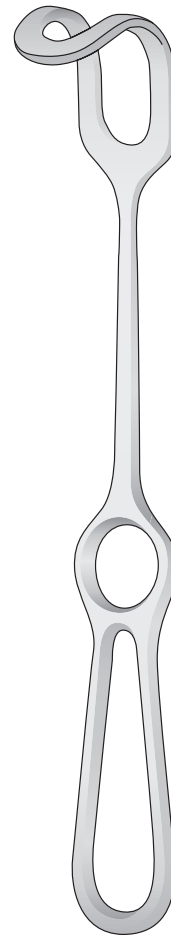

MIDDELDORPF  
**BT-80/BT-82**  
225 mm

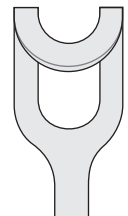

**BT-80**  
15 x 15 mm

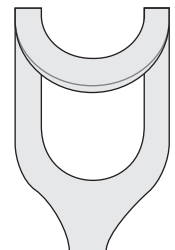

**BT-81**  
20 x 22 mm

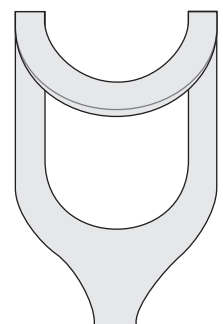

**BT-82**  
28 x 28 mm

Mundsperrer  
Mouth gags  
Apribocca  
Abrebocas  
Ouvre-bouche

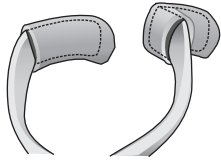

Paar Einsätze aus Silikon für:  
Pair of silicone inserts for:  
Coppia di inserti in silicone per:  
Pareja de inserto de silicone para:  
Paire de inserts en silicon pour:

**OM-40 - OM-41**

Ø 8 mm

Ø 11 mm



**OM-40R**  
30 mm

**OM-41R**  
30 mm

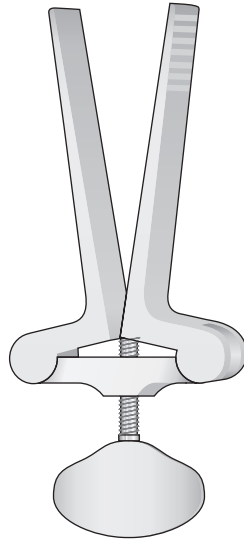

HEISTER  
**OM-62**  
135 mm

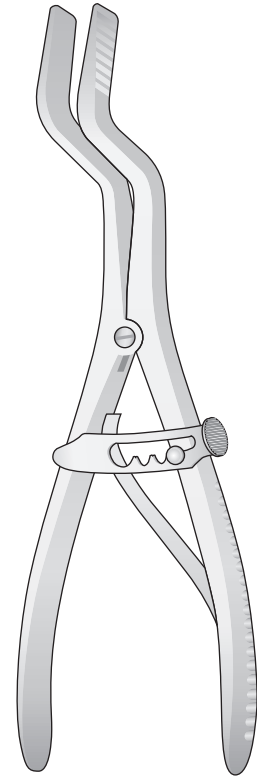

ROSER KÖNIG  
**OM-60**  
185 mm

Für Erwachsene  
For adults  
Per adulti  
Para adultos  
Pour adultes

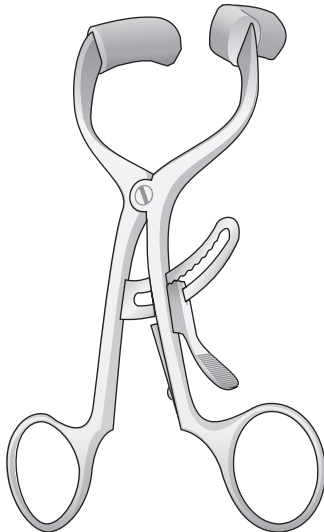

MOLT  
DOYEN-JANSEN  
**OM-41**  
140 mm

Für Erwachsene  
For adults  
Per adulti  
Para adultos  
Pour adultes

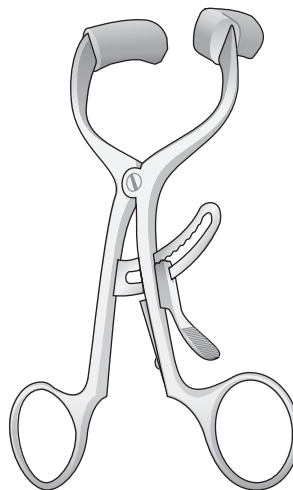

MOLT  
DOYEN-COLLIN  
**OM-40**  
120 mm

Für Kinder  
For children  
Per bambini  
Para niños  
Pour enfants

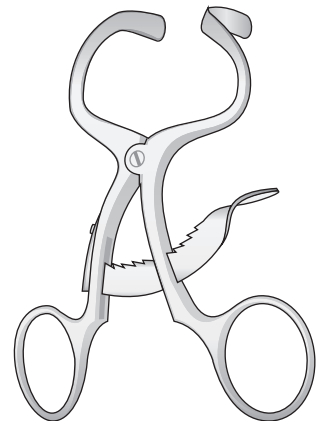

MOLT  
**OM-42**  
100 mm

Mundsperrer  
Mouth gags  
Apribocca  
Abrebocas  
Ouvre-bouche



Schwarzer Gummi  
Black Rubber  
Gomma nera  
Caucho negro  
Caoutchouc noir

LARGE  
Groß, für Erwachsene  
Large, for adults  
Grande, per adulti  
Grande, para adultos  
Grand, pour adultes

Dampfsterilisation bis 134°C  
Autoclavable to 134°C  
Autoclavabile a 134°C  
Autoclave hasta 134°C  
Autoclavable jusqu'à 134°C

Packung mit 2 Stück  
Package with 2 units  
Confezione da 2 pezzi  
Paquete con 2 unidades  
Boîte avec 2 pièces

**OM-72**



Mundsperrer  
Mouth gags  
Apribocca  
Abrebocas  
Ouvre-bouche

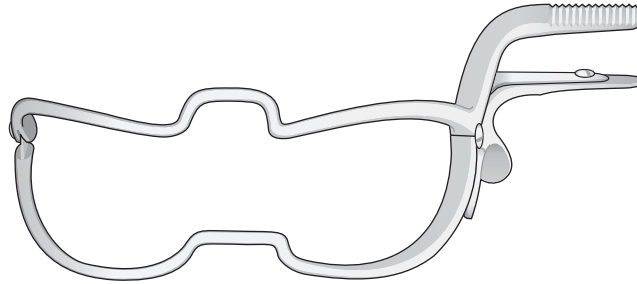

**WHITEHEAD-JENNINGS**

- OM-136** 90 mm
- OM-137** 110 mm
- OM-138** 130 mm
- OM-139** 150 mm

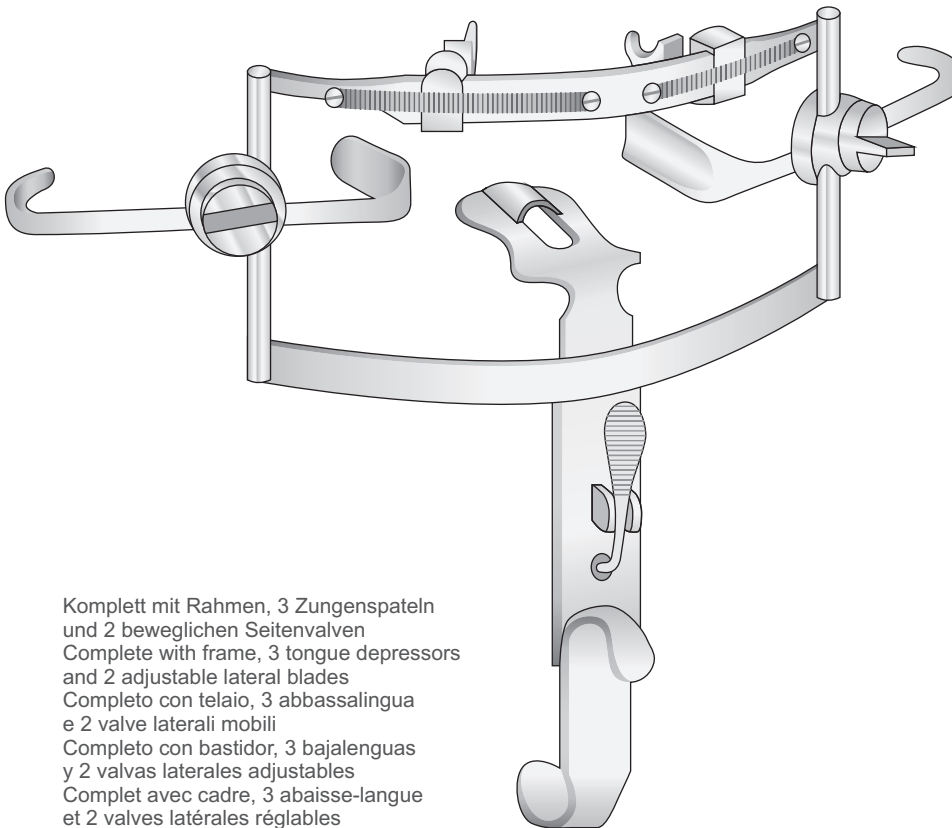

Komplett mit Rahmen, 3 Zungenspateln  
und 2 beweglichen Seitenvallen  
Complete with frame, 3 tongue depressors  
and 2 adjustable lateral blades  
Completo con telaio, 3 abbassalingua  
e 2 valve laterali mobili  
Completo con bastidor, 3 bajalenguas  
y 2 valvas laterales ajustables  
Complet avec cadre, 3 abaisse-langue  
et 2 valves latérales réglables

**DINGMANN**  
**OM-110**  
Set completo

**DINGMANN**  
Zungenspatel  
Tongue depressor  
Abbassalingua  
Bajalengua  
Abaisse langue

Fig. 1

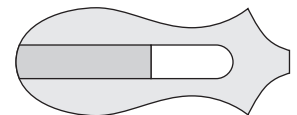

**OM-112**  
65 x 25 mm

Fig. 2

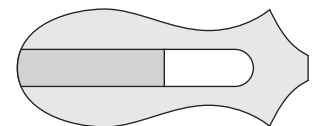

**OM-113**  
70 x 29 mm

Fig. 3

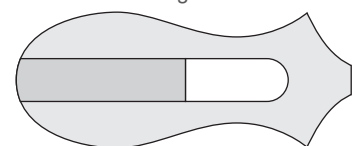

**OM-114**  
80 x 32 mm

DAVIS-BOYLE

**OM-150**

Komplet mit 5 Zungenspatel  
Complete with 5 tongue depressors  
Completo con 5 abbassalingua  
Completo con 5 abaja lengua  
Complet avec 5 abaisse-langues

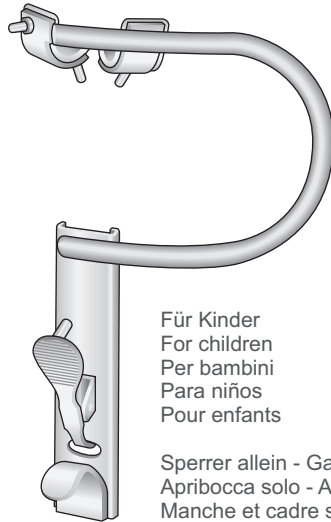

Für Kinder  
For children  
Per bambini  
Para niños  
Pour enfants

Sperrer allein - Gag only  
Apribocca solo - Apre-boca suelto  
Manche et cadre seuls

Zungenspatel  
Tongue depressors  
Abbassalingua  
Abaja lengua  
Abaisse-langues

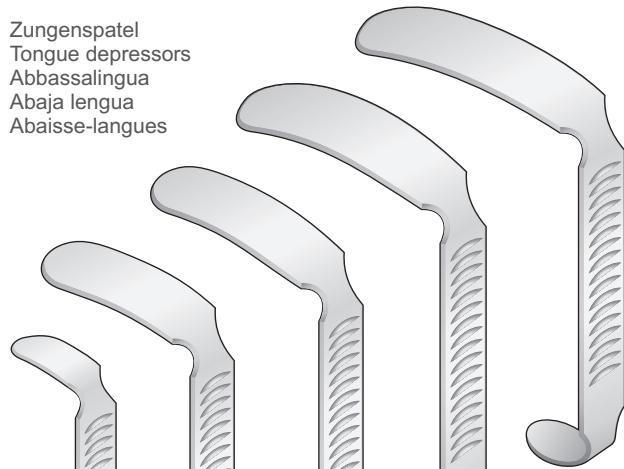

Fig. 1 Fig. 2 Fig. 3 Fig. 4 Fig. 5

- OM-152** Fig. 1 17x26 mm
- OM-153** Fig. 2 19x46 mm
- OM-154** Fig. 3 20x58 mm
- OM-155** Fig. 4 22x71 mm
- OM-156** Fig. 5 22x80 mm

DAVIS-BOYLE

**OM-151**

DAVIS-BOYLE

**OM-140**

Komplet mit 5 Zungenspatel  
Complete with 5 tongue depressors  
Completo con 5 abbassalingua  
Completo con 5 abaja lengua  
Complet avec 5 abaisse-langues



Sperrer allein  
Gag only  
Apribocca solo  
Apre-boca suelto  
Manche et cadre seuls

DAVIS-BOYLE

**OM-141**

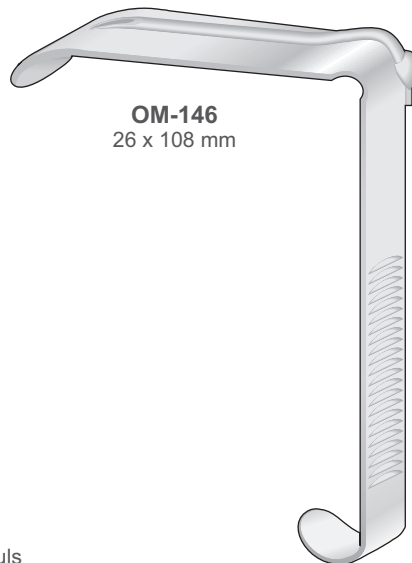

**OM-146**  
26 x 108 mm



**OM-145**  
25 x 93 mm



**OM-144**  
24 x 80 mm



**OM-143**  
23 x 65 mm

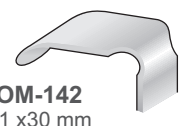

**OM-142**  
21 x 30 mm

**OM-142/OM-146**

Mundsperrer  
Mouth gags  
Apribocca  
Abrebocas  
Ouvre-bouche

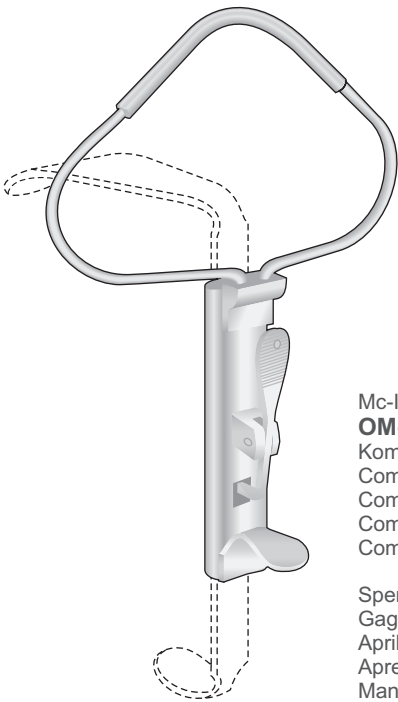

Mc-IVOR  
**OM-171**

Mc-IVOR  
**OM-170**  
Komplet mit 3 Zungenspatel  
Complete with 3 tongue depressors  
Completo di 3 abbassalingua  
Completo con 3 abaja lengua  
Complet avec 3 abaisse-langues

Sperrer allein  
Gag only  
Apribocca solo  
Apre-boca suelto  
Manche et cadre seuls

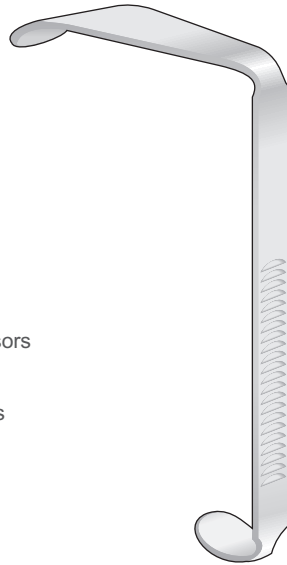

**OM-174**  
26 x 100 mm

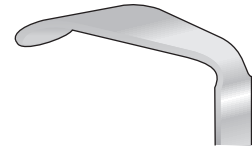

**OM-173**  
25 x 86 mm

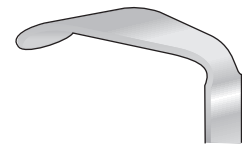

**OM-172**  
23 x 70 mm

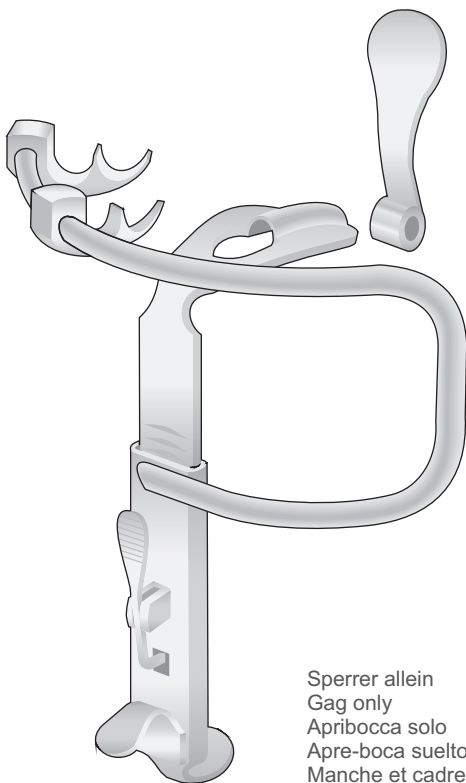

KILNER-DOUGHTY  
**OM-161**

Sperrer allein  
Gag only  
Apribocca solo  
Apre-boca suelto  
Manche et cadre seuls

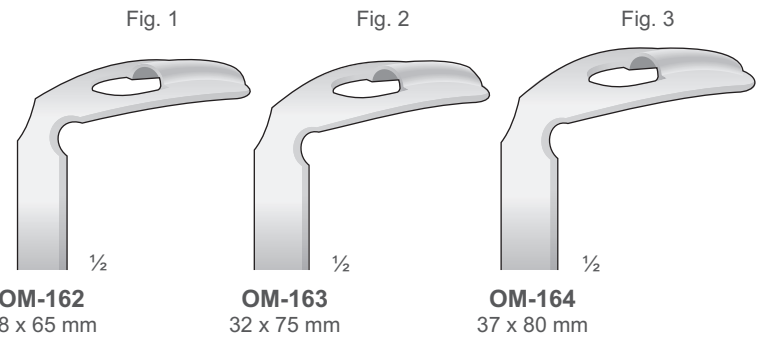

**OM-162**  
28 x 65 mm

**OM-163**  
32 x 75 mm

**OM-164**  
37 x 80 mm

KILNER-DOUGHTY  
**OM-160**  
Komplet mit 3 Zungenspatel  
Complete with 3 tongue depressors  
Completo con 3 abbassalingua  
Completo con 3 abaja lengua  
Complet avec 3 abaisse-langues

Nasen Spekula  
Nasal specula  
Speculum nasali  
Espéculos nasales  
Spéculums nasaux

Nasal spine  
Retractors

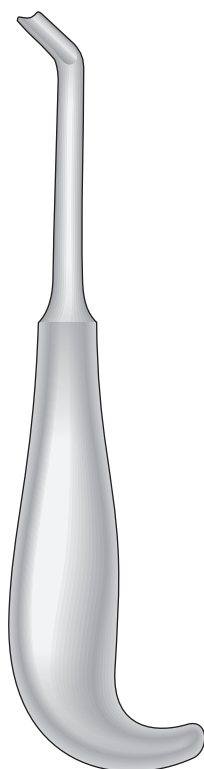

**DO-108**  
190 mm

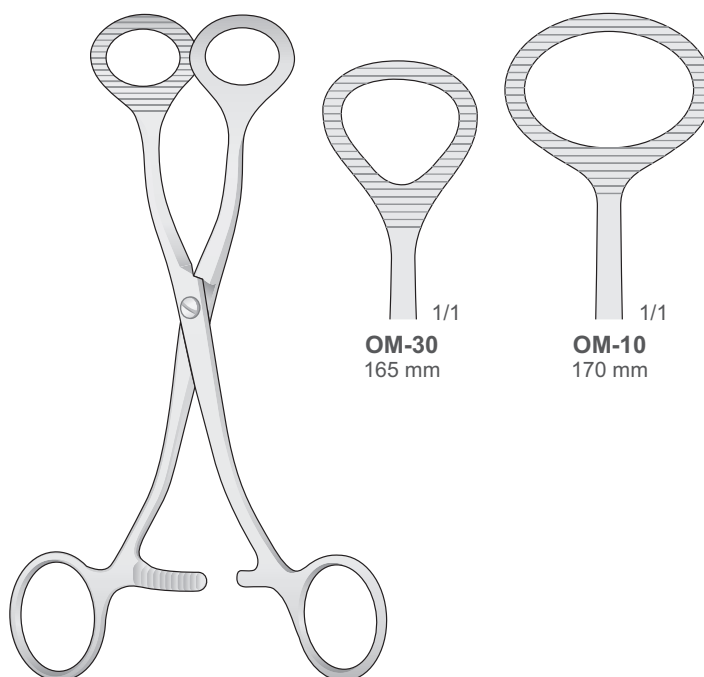

COLLIN  
**OM-10/OM-30**

**OM-30**  
165 mm

**OM-10**  
170 mm

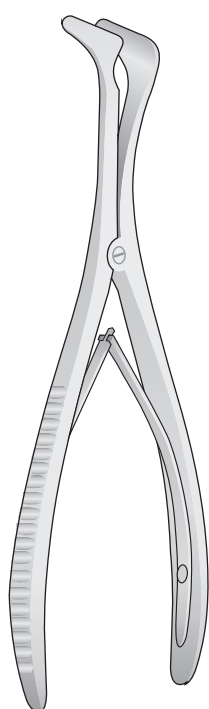

TIECK-HALLE  
**OM-48/OM-49**  
135 mm

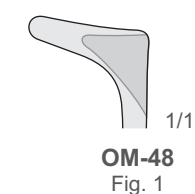

**OM-48**  
Fig. 1

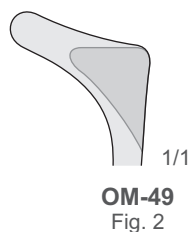

**OM-49**  
Fig. 2

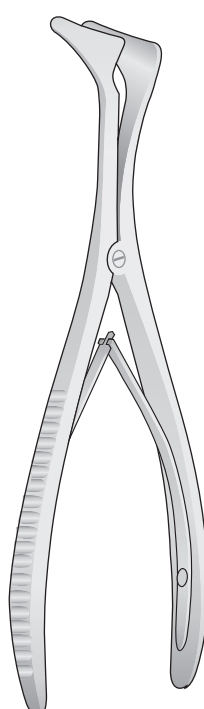

MODELL WIEN  
**OM-56/OM-59**  
140 mm

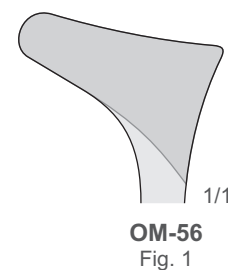

**OM-56**  
Fig. 1

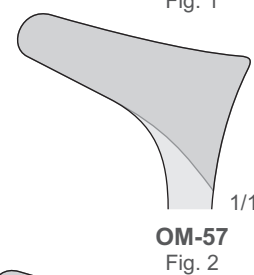

**OM-57**  
Fig. 2

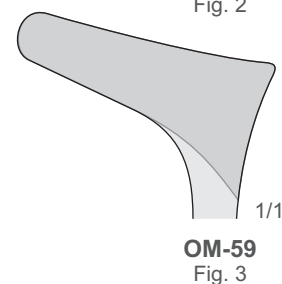

**OM-59**  
Fig. 3

Nasen Spekula  
Nasal specula  
Speculum nasali  
Espéculos nasales  
Spéculums nasaux

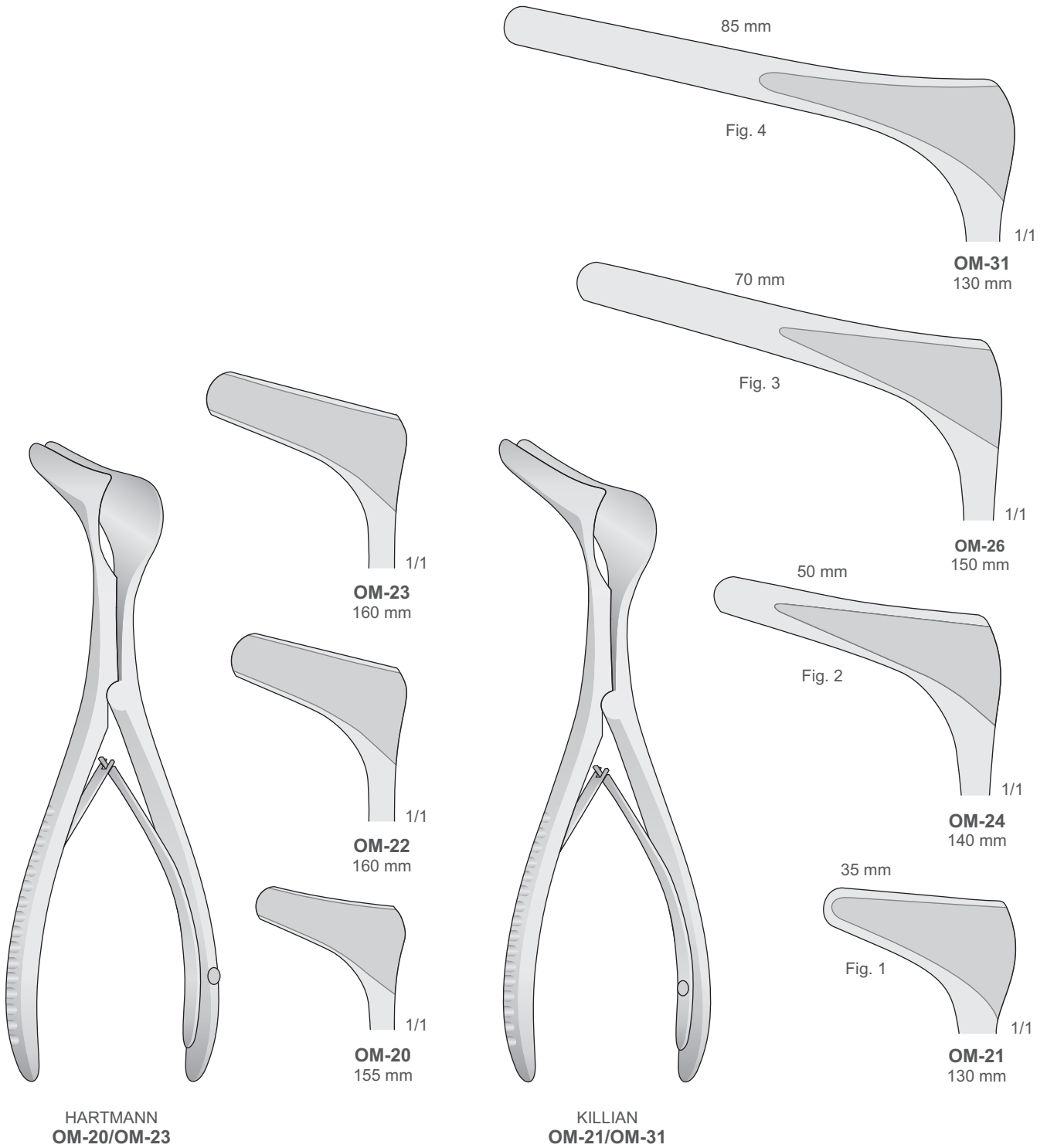

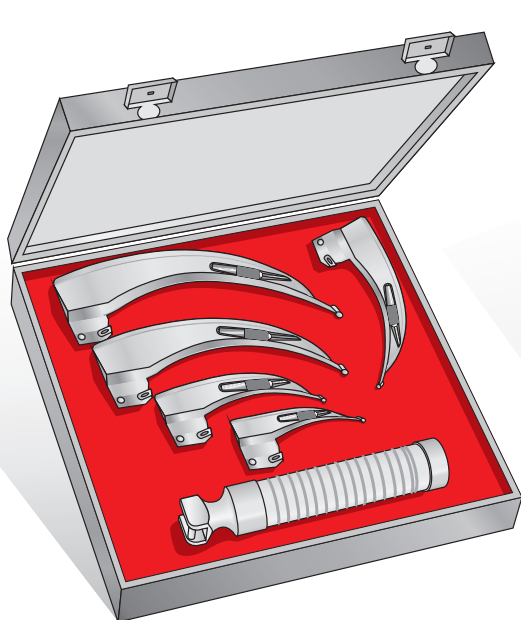

McINTOSH  
AA-S105

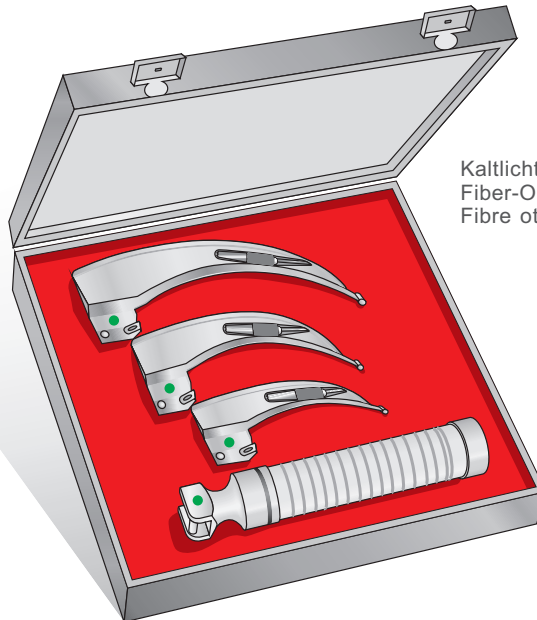

McINTOSH  
AA-S503

Kaltlicht  
Fiber-Optik  
Fibre ottiche

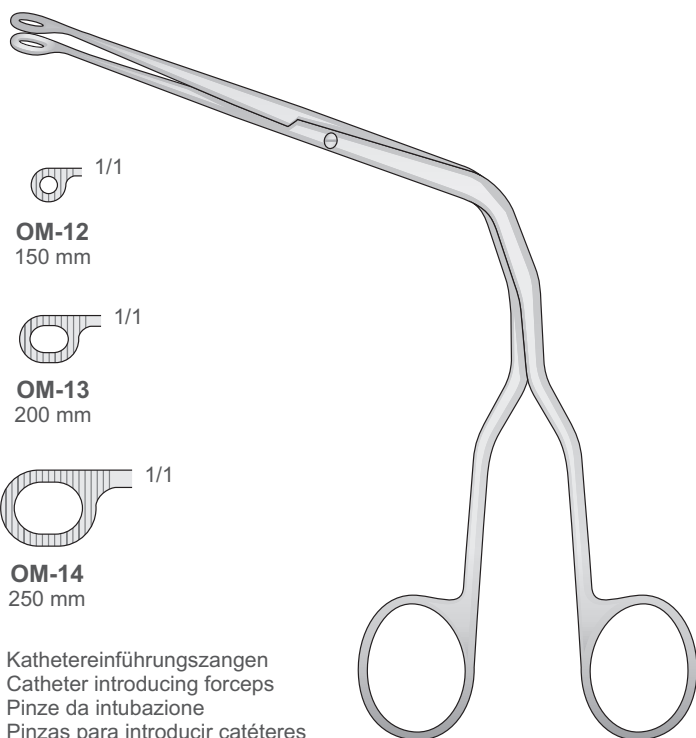

1/1  
**OM-12**  
150 mm

1/1  
**OM-13**  
200 mm

1/1  
**OM-14**  
250 mm

Kathetereinführungszangen  
Catheter introducing forceps  
Pinze da intubazione  
Pinzas para introducir catéteres

MAGILL  
OM-12/OM-14

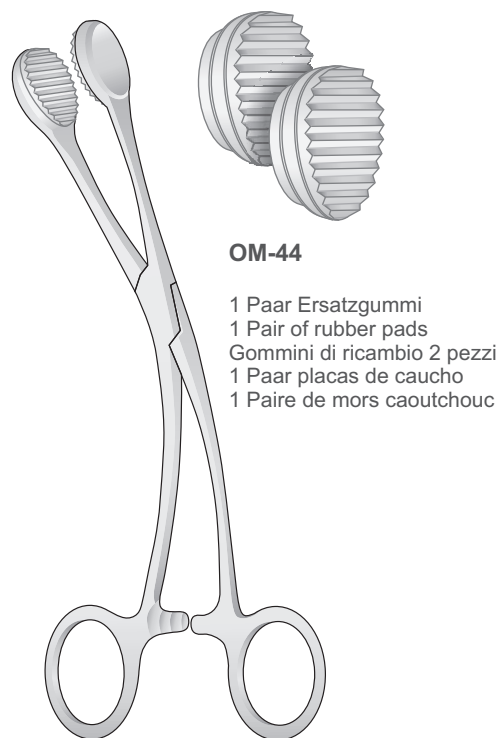

**OM-44**

1 Paar Ersatzgummi  
1 Pair of rubber pads  
Gommini di ricambio 2 pezzi  
1 Paar placas de caucho  
1 Paire de mors caoutchouc

YOUNG  
OM-45  
160 mm

Wundhaken  
Retractors  
Divaricatori  
Separadores  
Ecarteurs

6 x 13 mm

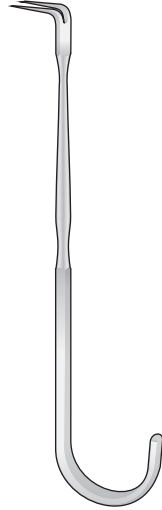

DUNN-DAUTREY  
**DO-198**  
130 mm

8 x 18 mm

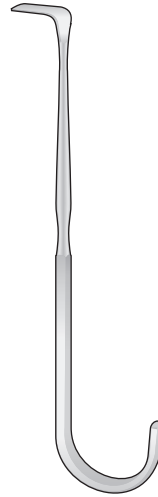

DUNN-DAUTREY  
**DO-199**  
125 mm

Posteriore  
Posterior

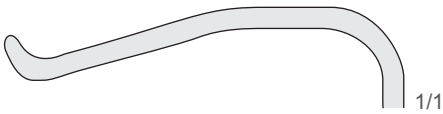

1/1

Anteriore  
Anterior

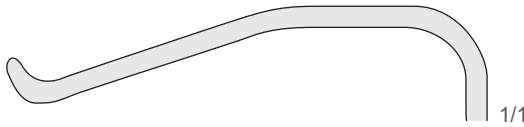

1/1

Superiore  
Superior

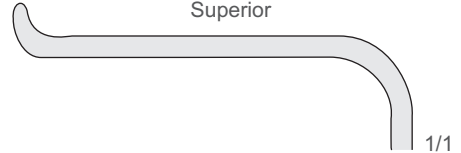

1/1

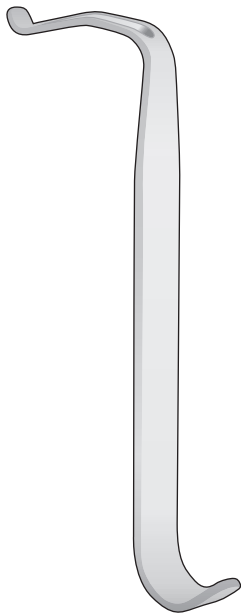

DUNN-DAUTREY  
**DO-94** 6,5 x 50 mm  
140 mm

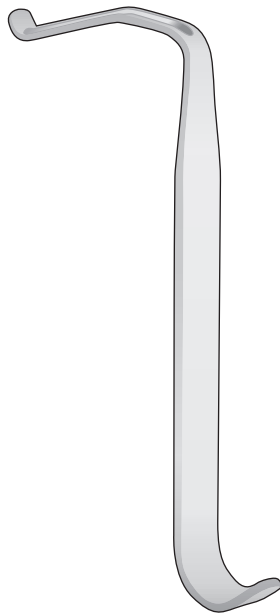

DUNN-DAUTREY  
**DO-95** 6,5 x 60 mm  
140 mm

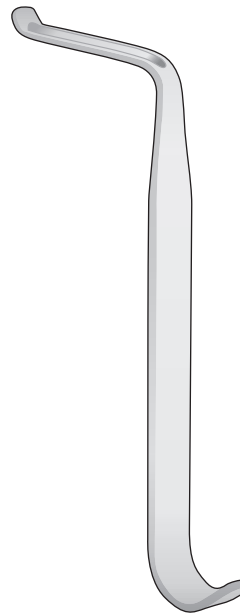

DUNN-DAUTREY  
**DO-96** 8 x 50 mm  
140 mm

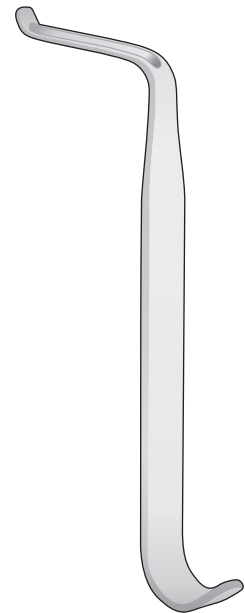

DUNN-DAUTREY  
**DO-97** 6,5 x 50 mm  
140 mm

Chirurgische Scheren  
Operating scissors  
Forbici chirurgiche  
Tijeras para cirugía general  
Ciseaux chirurgicaux

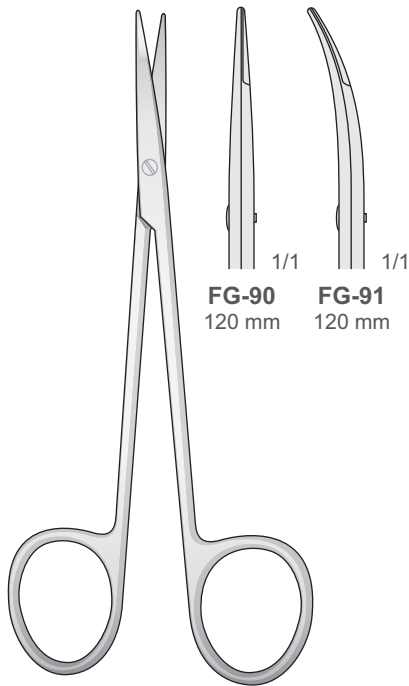

SHEA  
**FG-90/FG-91**  
120 mm

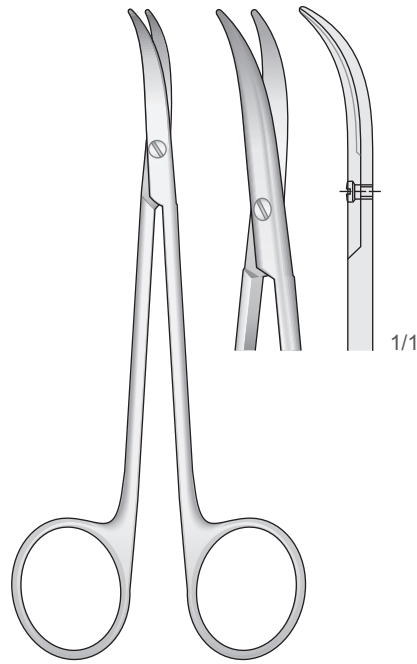

CINELLI  
**FG-95**  
115 mm

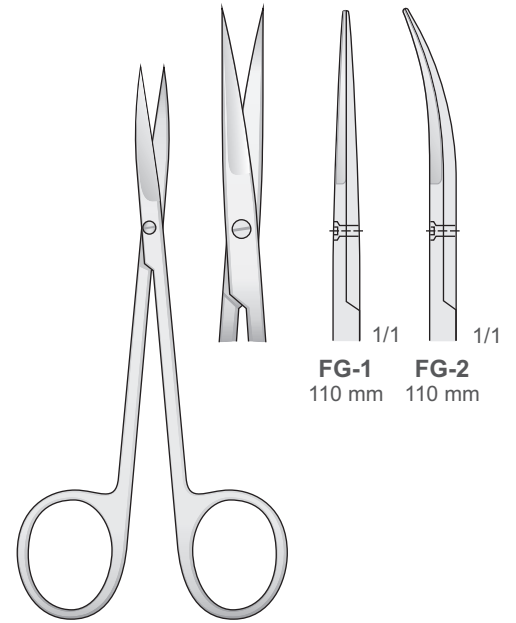

IRIS  
**FG-1/FG-2**  
110 mm

Gezahnt - Serrated  
Dentellate - Dentadas  
Dentelé

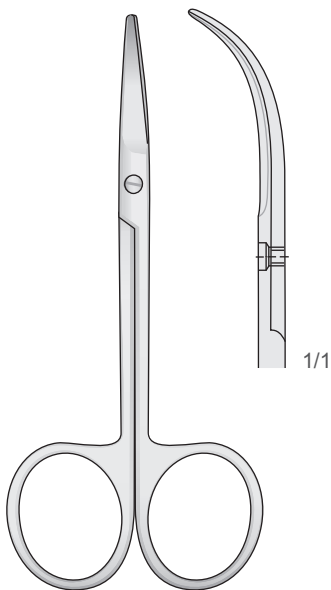

FOMON  
**FG-43**  
110 mm

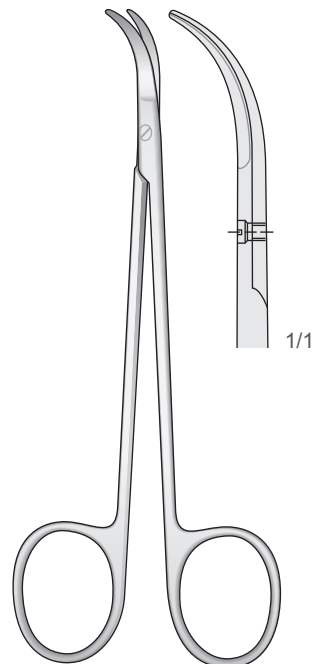

FOMON  
**FG-93**  
135 mm

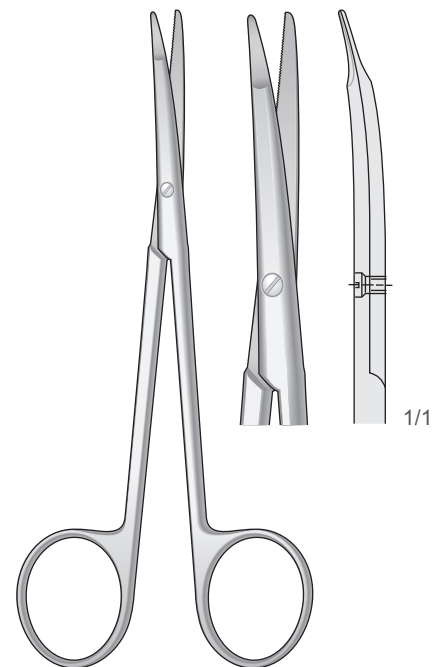

KILNER  
**FG-121**  
130 mm



Chirurgische Scheren  
Operating scissors  
Forbici chirurgiche  
Tijeras para cirugía general  
Ciseaux chirurgicaux

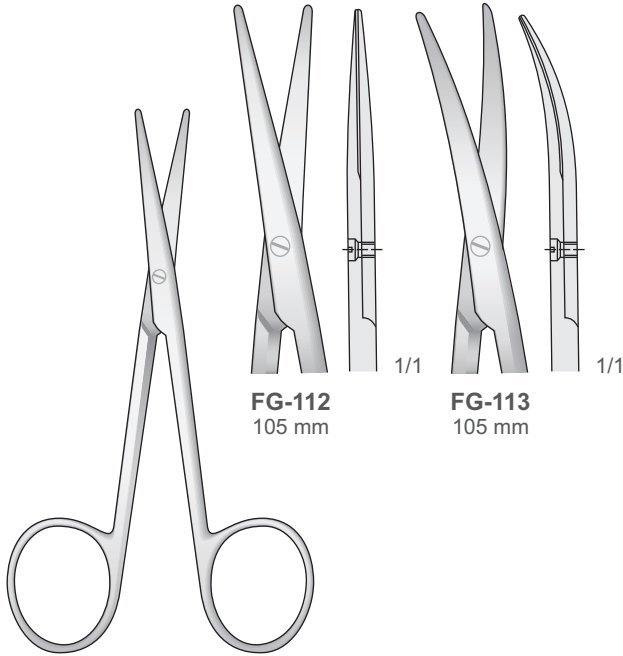

**FG-112**  
105 mm

**FG-113**  
105 mm

**COTTLE-KNAPP**  
**FG-112/FG-113**  
105 mm  
(LEXER-BABY)

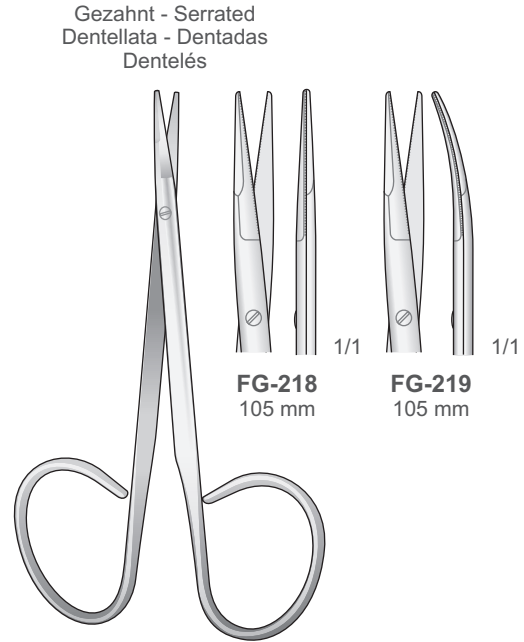

**FG-218**  
105 mm

**FG-219**  
105 mm

**KAYE**  
**FG-218/FG-219**  
105 mm

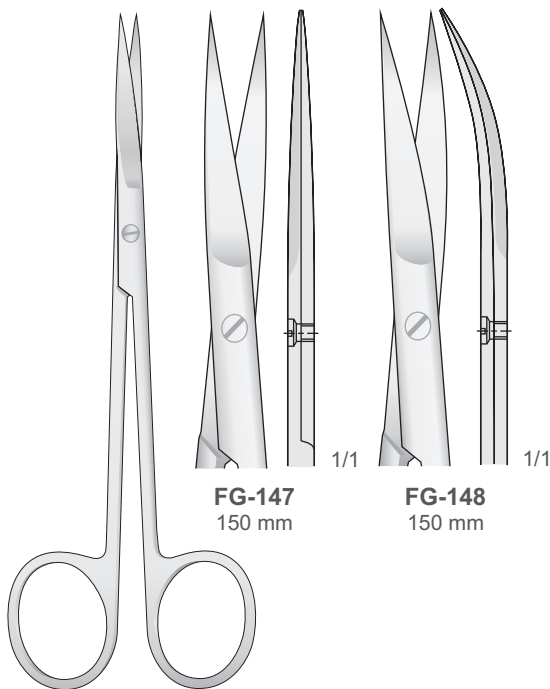

**FG-147**  
150 mm

**FG-148**  
150 mm

**JOSEPH**  
**FG-147/FG-148**  
150 mm

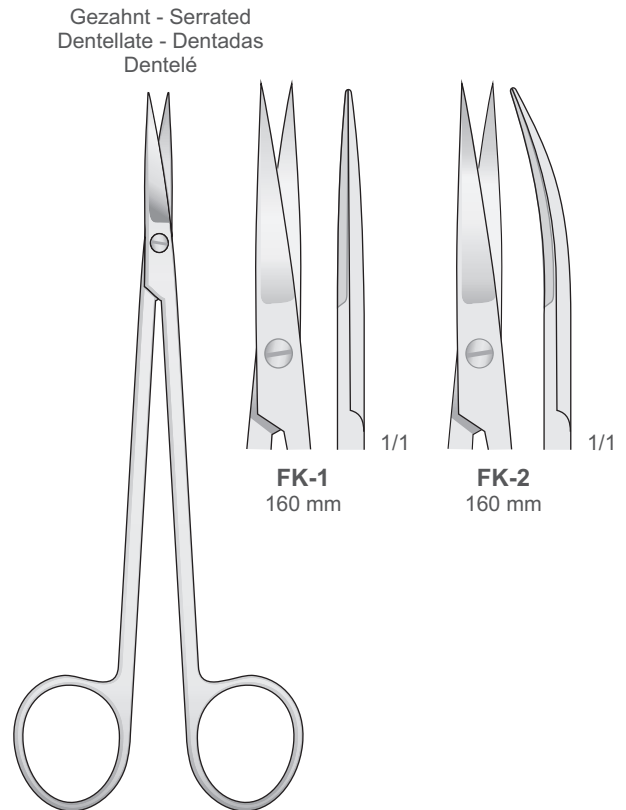

**FK-1**  
160 mm

**FK-2**  
160 mm

**KELLY**  
**FK-1/FK-2**  
160 mm

Chirurgische Scheren  
Operating scissors  
Forbici chirurgiche  
Tijeras para cirugía general  
Ciseaux chirurgicaux

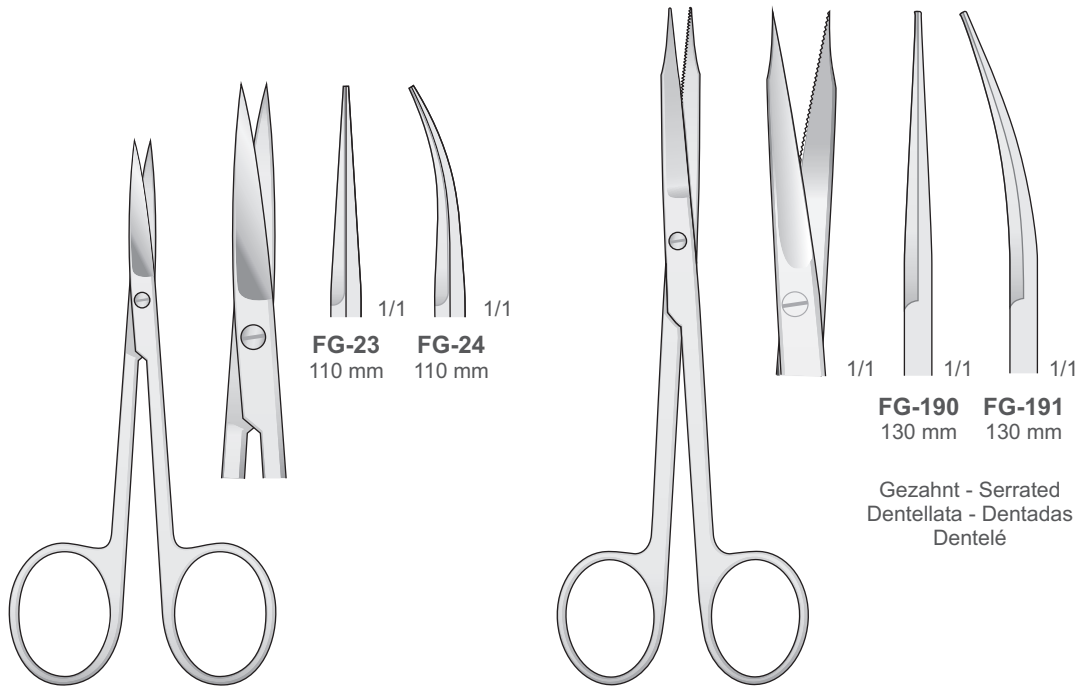

**FG-23** 110 mm  
**FG-24** 110 mm

**FG-190** 130 mm  
**FG-191** 130 mm

Gezahnt - Serrated  
Dentellata - Dentadas  
Dentelé

**FG-23/FG-24**  
110 mm

**GOLDMAN-FOX**  
**FG-190/FG-191**  
130 mm

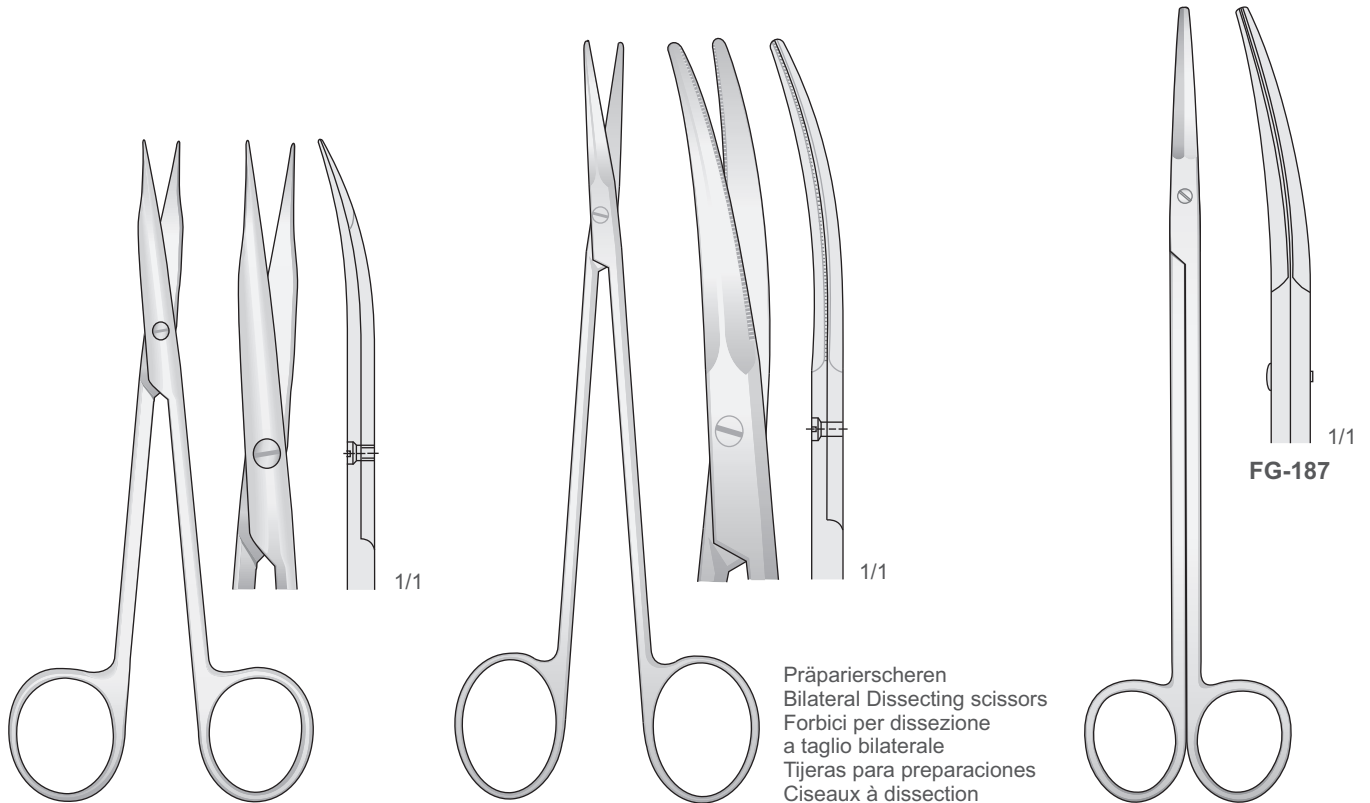

**JAMESON**  
**FG-124**  
145 mm

**GORNEY**  
**FG-127**  
195 mm

**KAHN**  
**FG-187**  
205 mm

Präparierscheren  
Bilateral Dissecting scissors  
Forbici per dissezione  
a taglio bilaterale  
Tijeras para preparaciones  
Ciseaux à dissection

Chirurgische Scheren  
Operating scissors  
Forbici chirurgiche  
Tijeras para cirugía general  
Ciseaux chirurgicaux

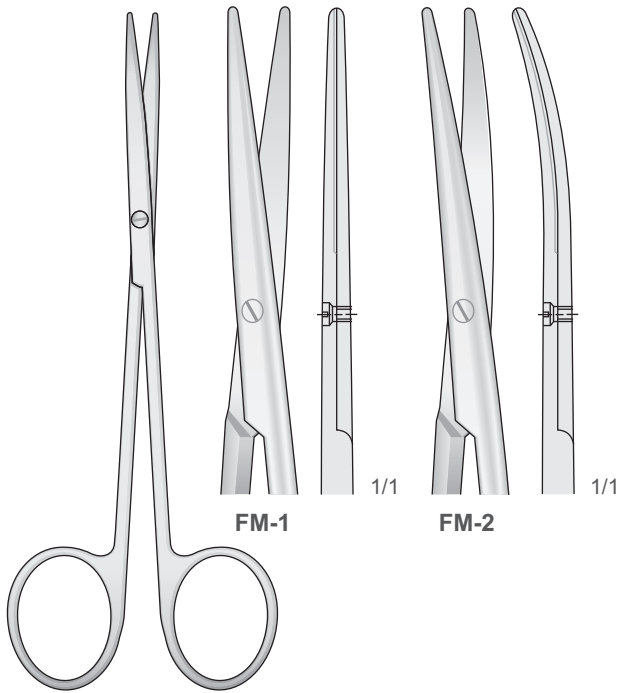

METZENBAUM  
**FM-1/FM-2**  
145 mm

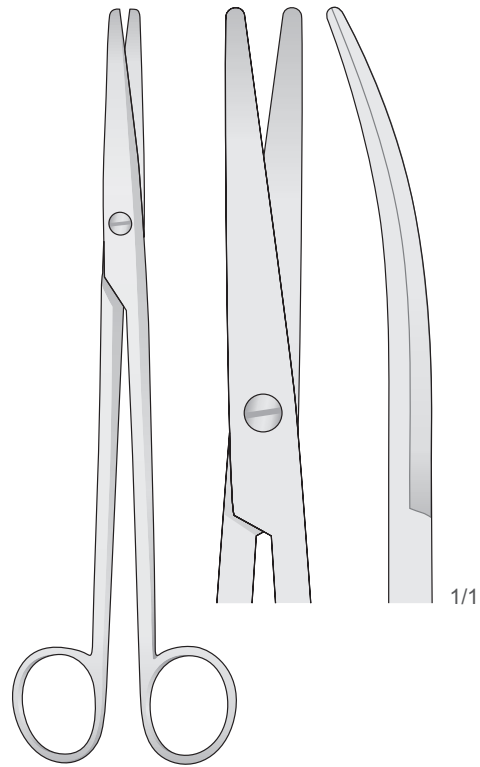

MAYO-LEXER  
**FM-79**  
165 mm

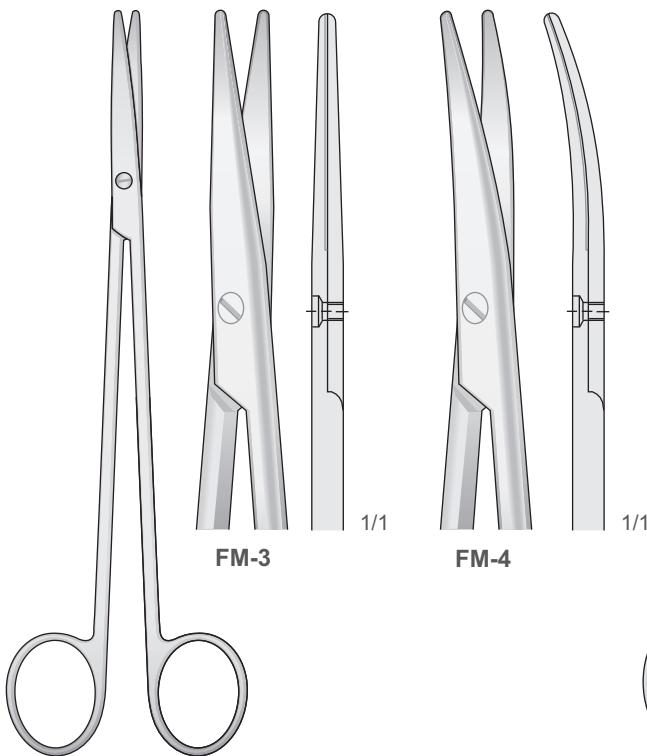

METZENBAUM  
**FM-3/FM-4**  
185 mm

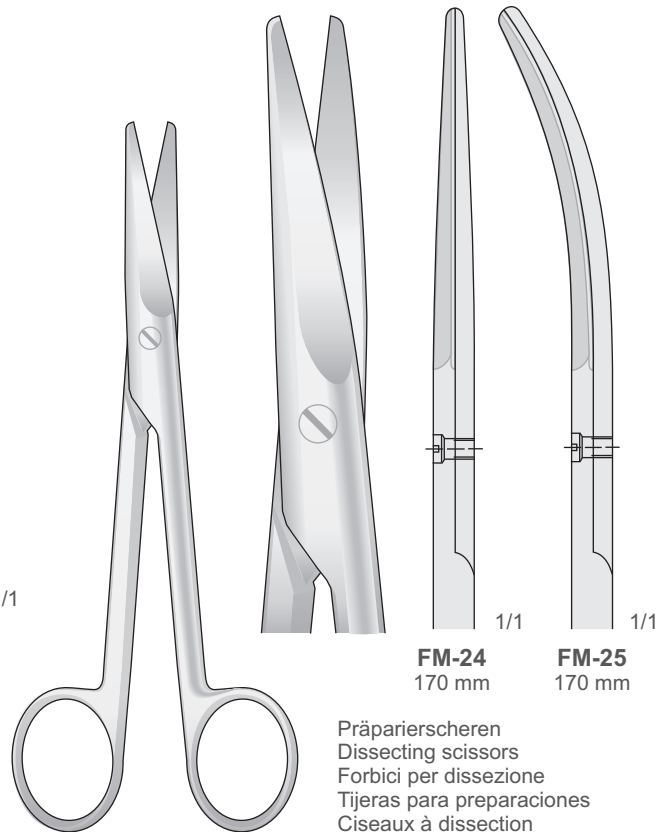

MAYO  
**FM-24/FM-25**  
170 mm

Präparierscheren  
Dissecting scissors  
Forbici per dissezione  
Tijeras para preparaciones  
Ciseaux à dissection

Mit Hartmetalleinsätzen  
Tungsten-carbide scissors  
Con punta al carburo di tungsteno  
Tijeras de tungsteno  
Avec plaquettes en carbure de tungstène

Chirurgische Scheren  
Operating scissors  
Forbici chirurgiche  
Tijeras para cirugía general  
Ciseaux chirurgicaux

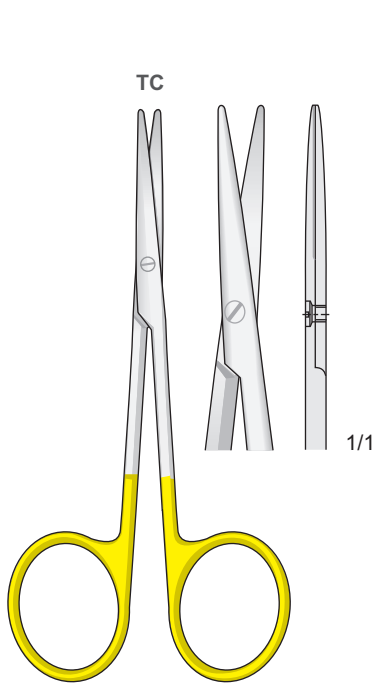

**FM-118**  
115 mm

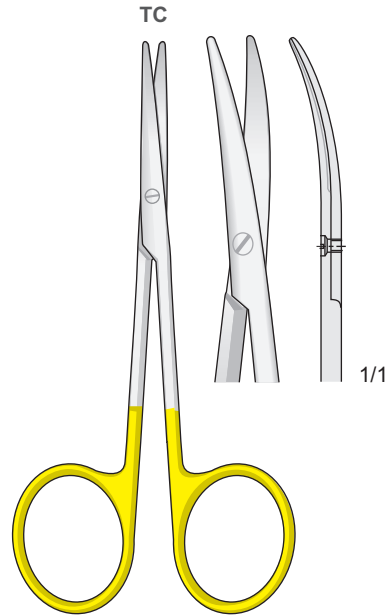

**FM-119**  
115 mm

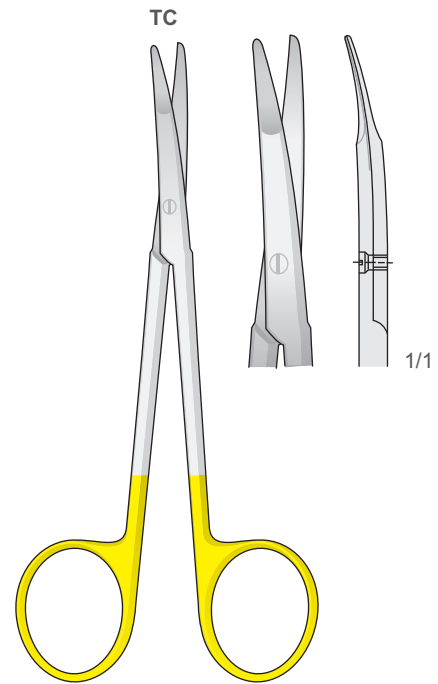

**KILNER (RAGNELL)**  
**FM-350**  
125 mm

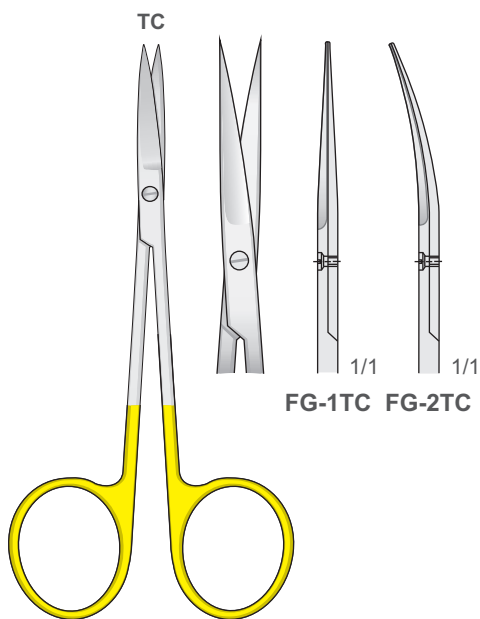

**IRIS**  
**FG-1TC/FG-2TC**  
115 mm

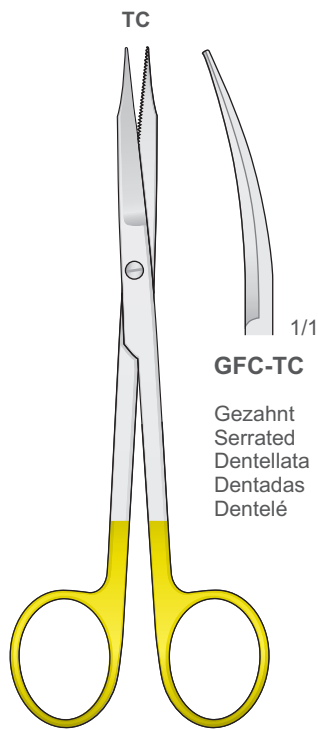

**GOLDMAN-FOX**  
**GFC-TC**  
135 mm

**GFC-TC**  
Gezant  
Serrated  
Dentellata  
Dentadas  
Dentelé

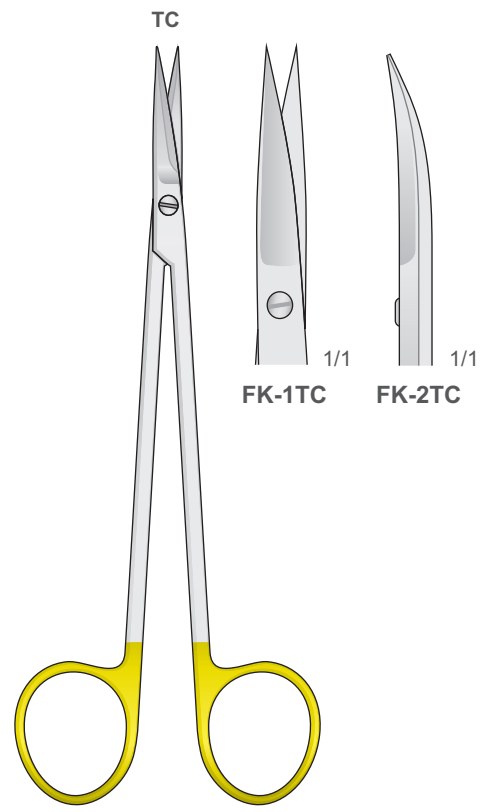

**KELLY**  
**FK-1TC/FK-2TC**  
160 mm

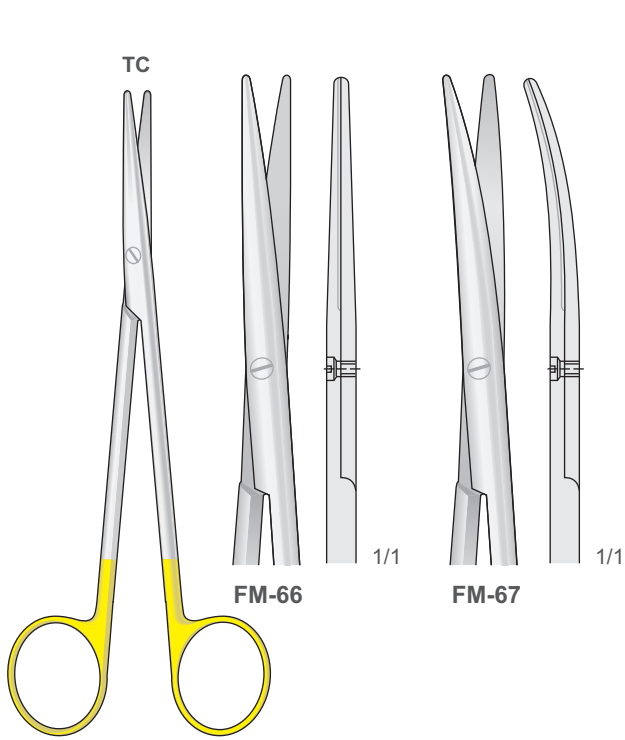

METZENBAUM  
FM-66/FM-67  
145 mm

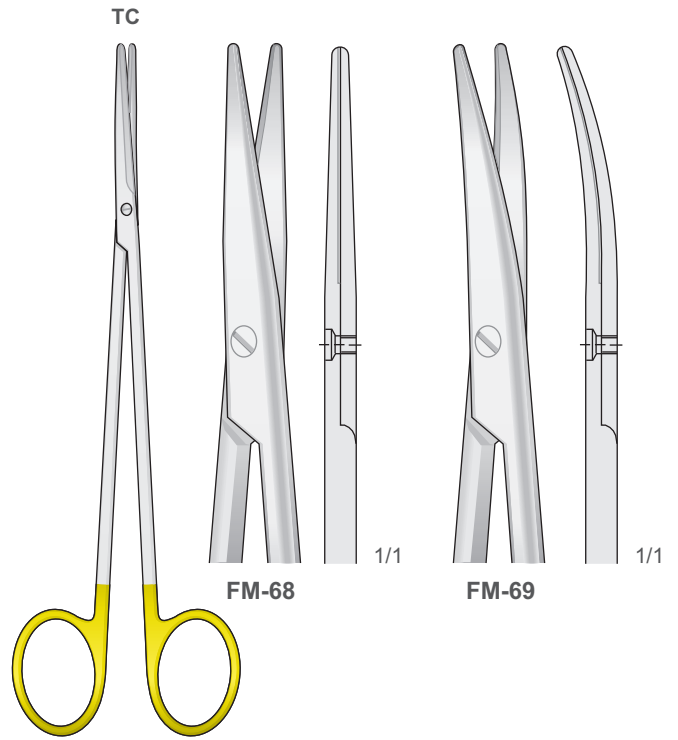

METZENBAUM  
FM-68/FM-69  
185 mm

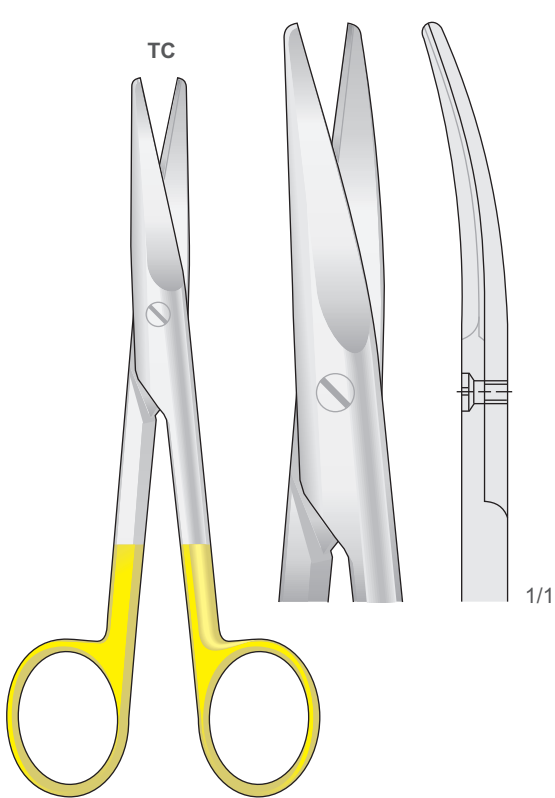

MAYO  
FM-141  
140 mm

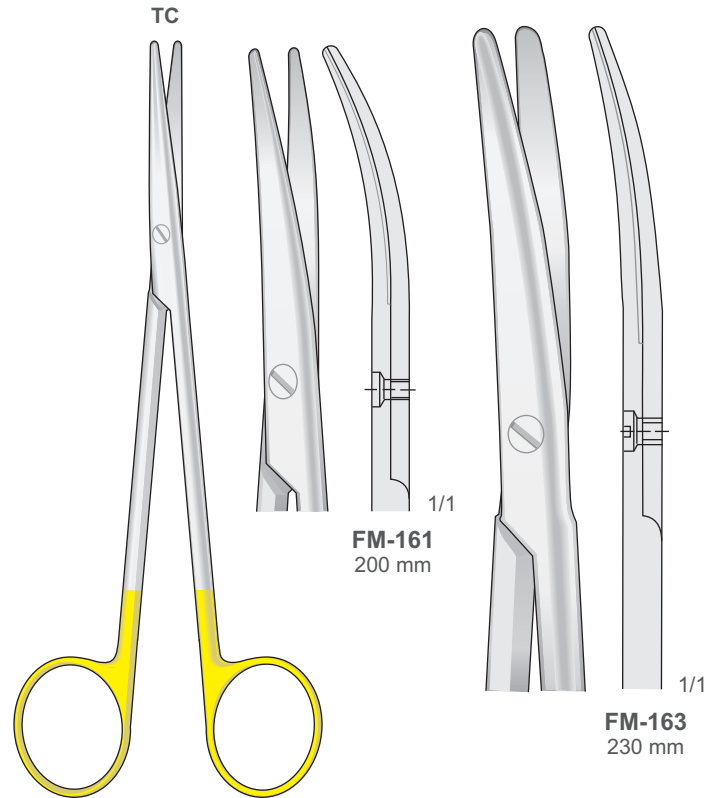

METZENBAUM  
FM-161/FM-163  
200 mm

FM-163  
230 mm

Mit Hartmetalleinsätzen  
Tungsten-carbide scissors  
Con punta al carburo di tungsteno  
Tijeras de tungsteno  
Avec plaquettes en carbure de tungstène

Chirurgische Scheren  
Operating scissors  
Forbici chirurgiche  
Tijeras para cirugía general  
Ciseaux chirurgicaux

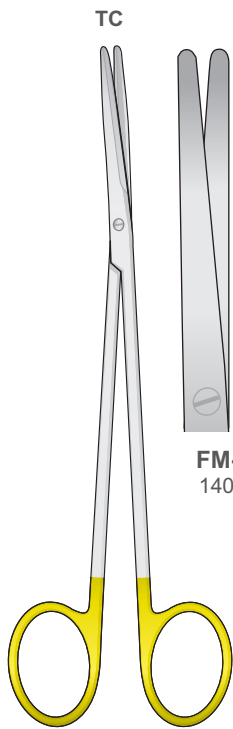

**FM-202**  
140 mm

**FM-204**  
180 mm

**FM-206**  
200 mm

METZENBAUM-FINO  
**FM-202/FM-206**

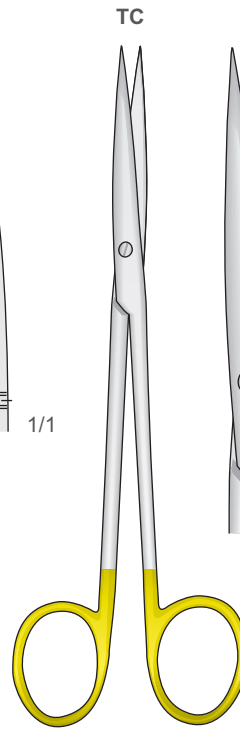

**FM-98**  
140 mm

**FM-99**  
180 mm

METZENBAUM-FINO  
**FM-98/FM-99**

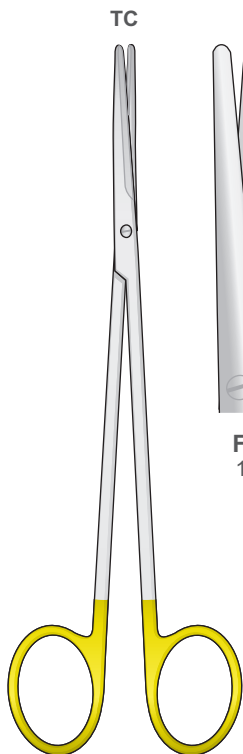

**FM-201**  
140 mm

**FM-203**  
180 mm

METZENBAUM-FINO  
**FM-201/FM-203**

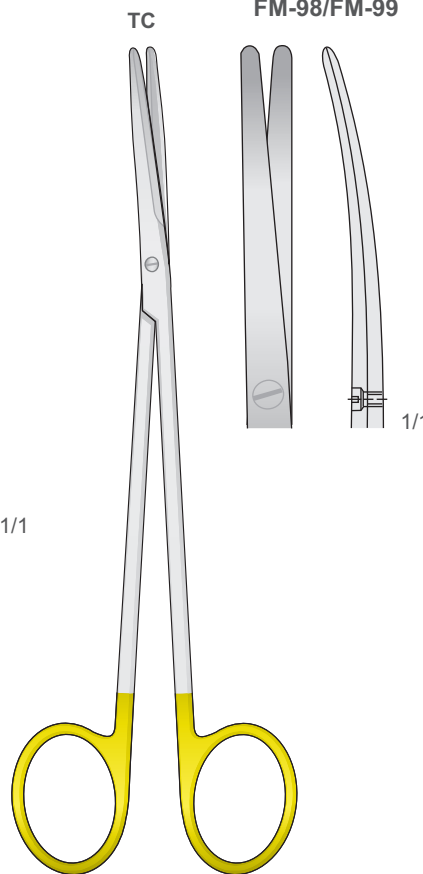

METZENBAUM-FINO  
**FM-208**  
230 mm

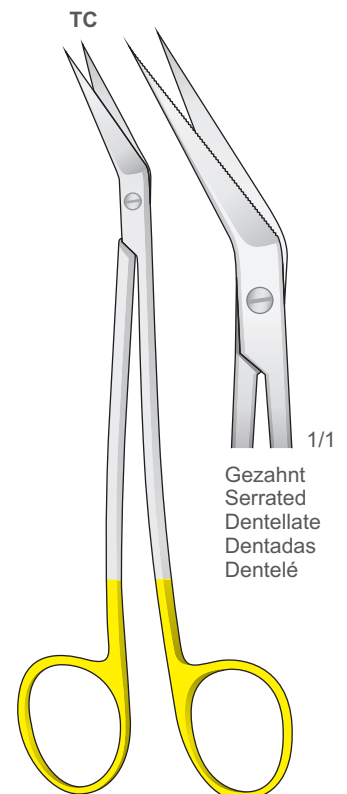

Gezahnt  
Serrated  
Dentellate  
Dentadas  
Dentelé

**LK-12**  
160 mm

Chirurgische Scheren  
Operating scissors  
Forbici chirurgiche  
Tijeras para cirugía general  
Ciseaux chirurgicaux

Mit Hartmetalleinsätzen  
Tungsten-carbide scissors  
Con punta al carburo di tungsteno  
Tijeras de tungsteno  
Avec plaquettes en carbure de tungstène

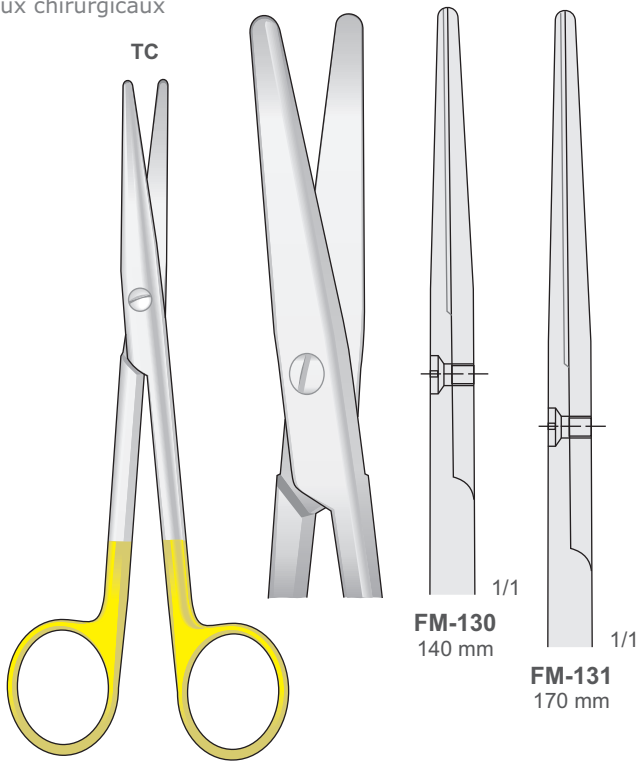

MAYO-STILLE  
FM-130/FM-131

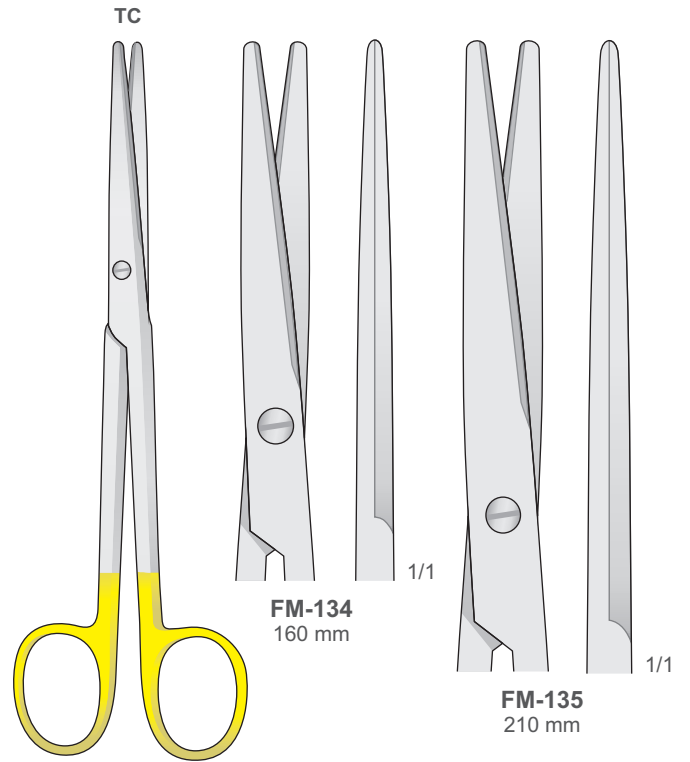

LEXER  
FM-134/FM-135

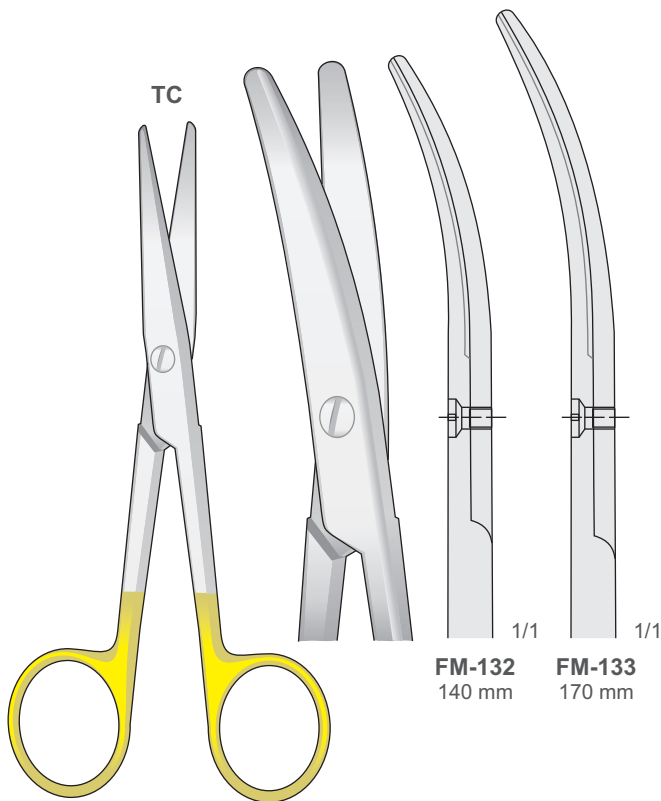

MAYO-STILLE  
FM-132/FM-133

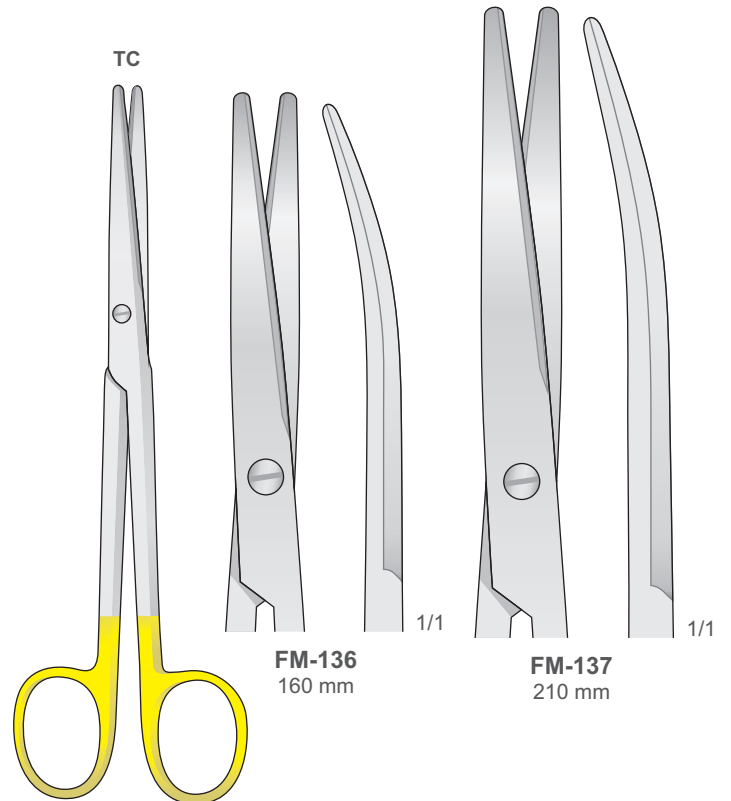

LEXER  
FM-136/FM-137

Mit Hartmetalleinsätzen  
Tungsten-carbide scissors  
Con punta al carburo di tungsteno  
Tijeras de tungsteno  
Avec plaquettes en carbure de tungstène

Chirurgische Scheren  
Operating scissors  
Forbici chirurgiche  
Tijeras para cirugía general  
Ciseaux chirurgicaux

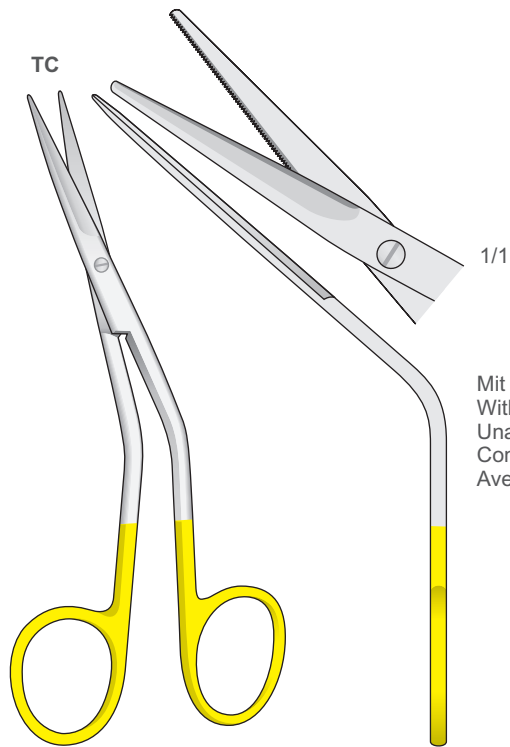

1/1

Mit 1 Schneide Gezahnt  
With 1 Blade Serrated  
Una lama dentellata  
Con 1 hoja dentadas  
Avec 1 lame dentelé

FOMON  
**FG-165**  
135 mm

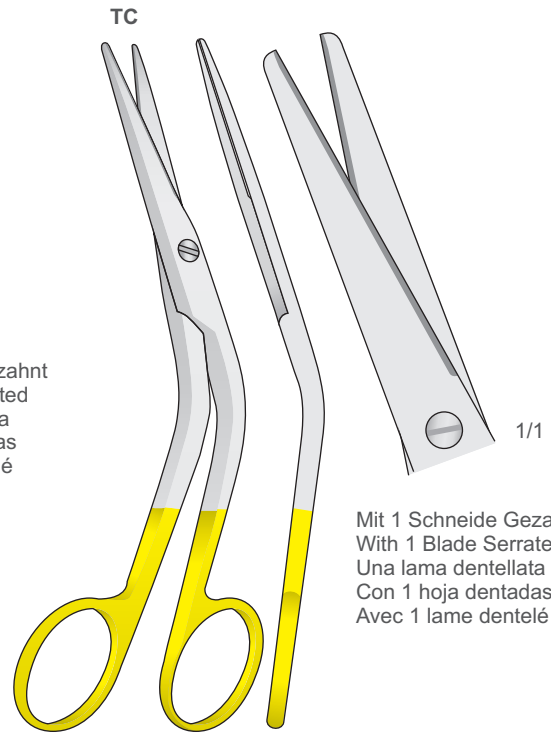

1/1

Mit 1 Schneide Gezahnt  
With 1 Blade Serrated  
Una lama dentellata  
Con 1 hoja dentadas  
Avec 1 lame dentelé

COTTLE  
**FG-166**  
160 mm

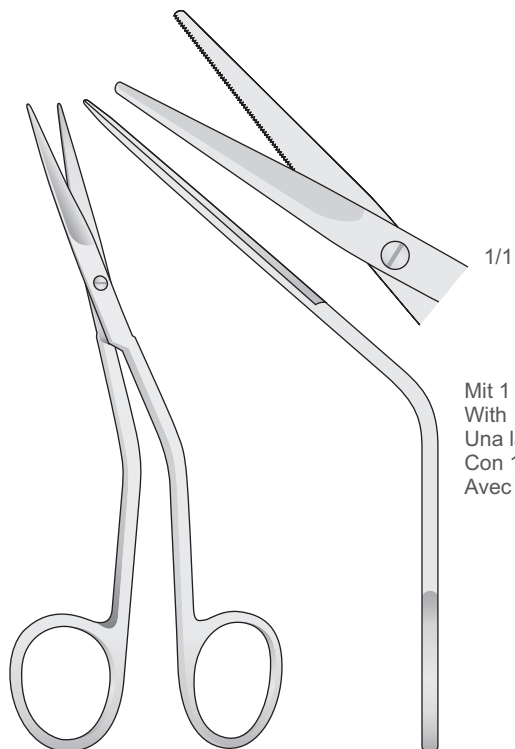

1/1

Mit 1 Schneide Gezahnt  
With 1 Blade Serrated  
Una lama dentellata  
Con 1 hoja dentadas  
Avec 1 lame dentelé

FOMON  
**FG-41**  
135 mm

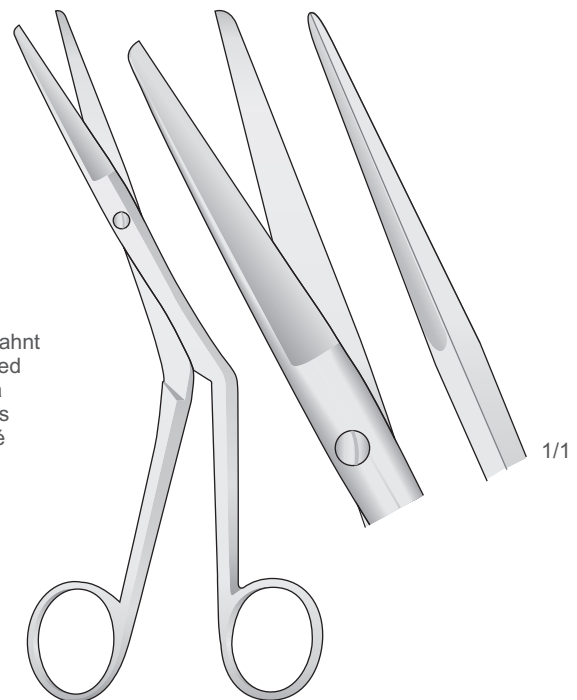

1/1

HEYMANN  
**FG-8**  
180 mm



Chirurgische pinzetten  
Tissue forceps  
Pinzette chirurgiche  
Pinzas quirúrgicas  
Pincas quirurgicales

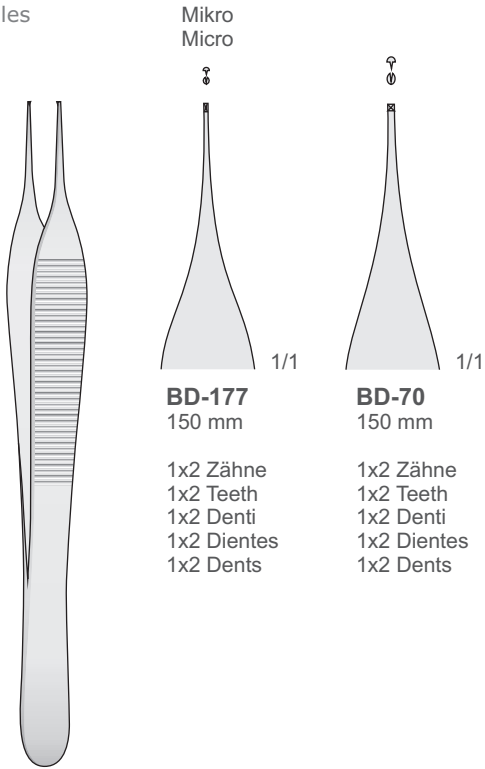

**BD-177**  
150 mm

1x2 Zähne  
1x2 Teeth  
1x2 Denti  
1x2 Dientes  
1x2 Dents

**BD-70**  
150 mm

1x2 Zähne  
1x2 Teeth  
1x2 Denti  
1x2 Dientes  
1x2 Dents

ADSON  
**BD-70/BD-177**  
150 mm

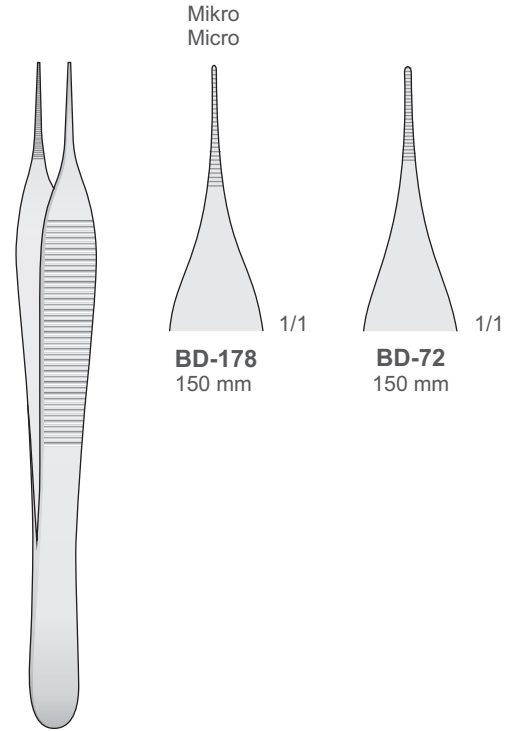

**BD-178**  
150 mm

1x2 Zähne  
1x2 Teeth  
1x2 Denti  
1x2 Dientes  
1x2 Dents

**BD-72**  
150 mm

1x2 Zähne  
1x2 Teeth  
1x2 Denti  
1x2 Dientes  
1x2 Dents

ADSON  
**BD-72/BD-178**  
150 mm

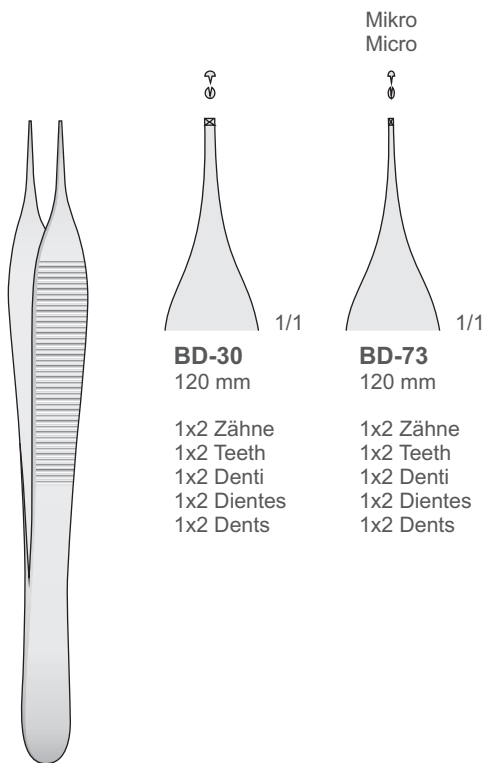

**BD-30**  
120 mm

1x2 Zähne  
1x2 Teeth  
1x2 Denti  
1x2 Dientes  
1x2 Dents

**BD-73**  
120 mm

1x2 Zähne  
1x2 Teeth  
1x2 Denti  
1x2 Dientes  
1x2 Dents

ADSON  
**BD-30/BD-73**  
120 mm

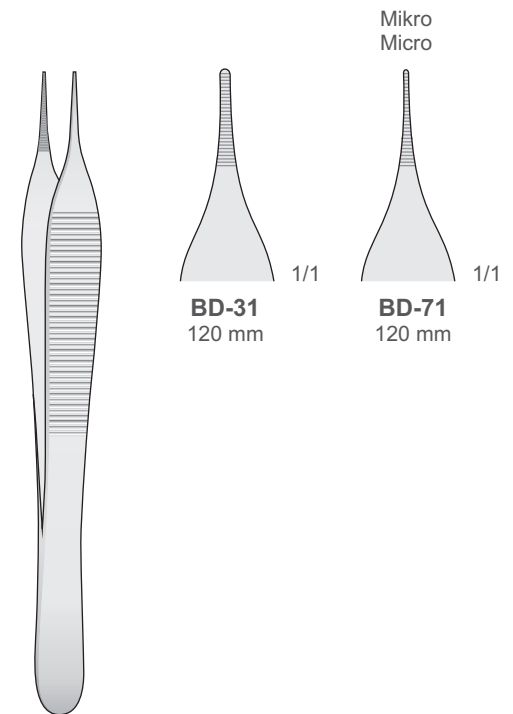

**BD-31**  
120 mm

1x2 Zähne  
1x2 Teeth  
1x2 Denti  
1x2 Dientes  
1x2 Dents

**BD-71**  
120 mm

1x2 Zähne  
1x2 Teeth  
1x2 Denti  
1x2 Dientes  
1x2 Dents

ADSON  
**BD-31/BD-71**  
120 mm

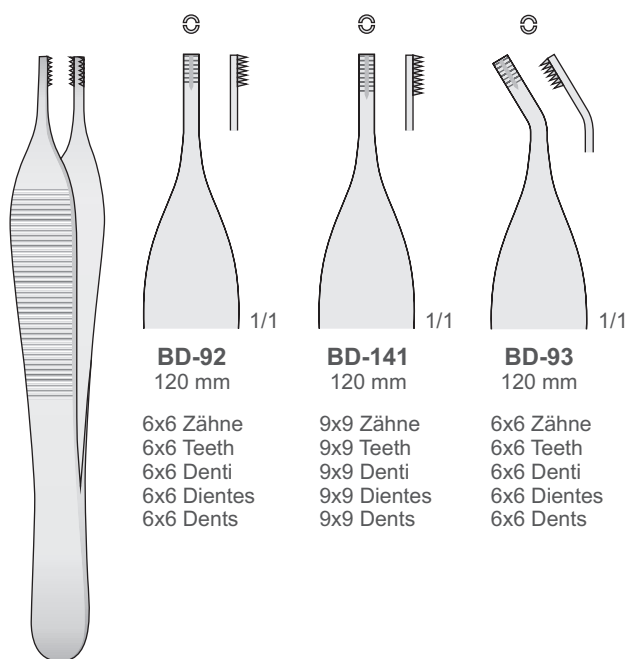

**BD-92**  
120 mm

6x6 Zähne  
6x6 Teeth  
6x6 Denti  
6x6 Dientes  
6x6 Dents

**BD-141**  
120 mm

9x9 Zähne  
9x9 Teeth  
9x9 Denti  
9x9 Dientes  
9x9 Dents

**BD-93**  
120 mm

6x6 Zähne  
6x6 Teeth  
6x6 Denti  
6x6 Dientes  
6x6 Dents

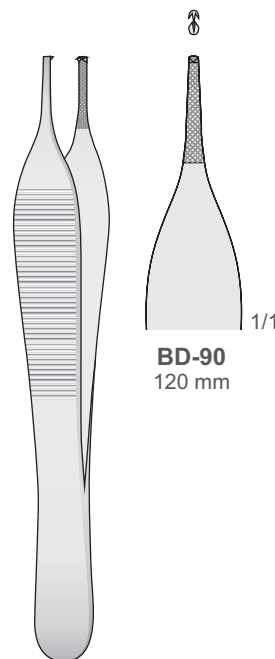

**BD-90**  
120 mm

ADSON-BROWN  
**BD-92/BD-141**  
120 mm

ADSON  
**BD-90**  
120 mm

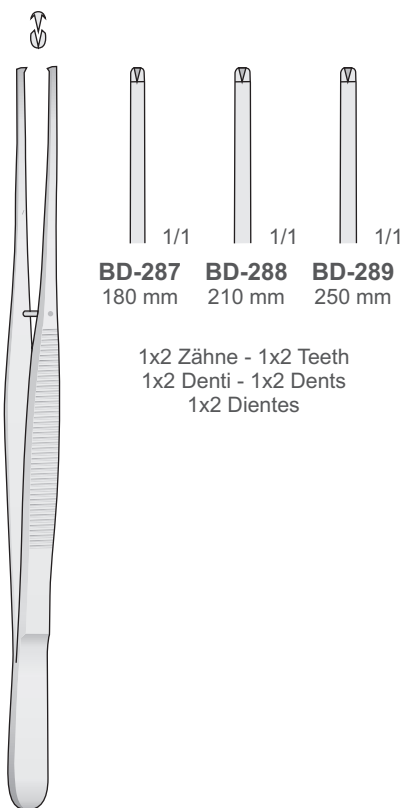

**BD-287**  
180 mm

**BD-288**  
210 mm

**BD-289**  
250 mm

1x2 Zähne - 1x2 Teeth  
1x2 Denti - 1x2 Dents  
1x2 Dientes

POTTS-SMITH  
**BD-287/BD-289**

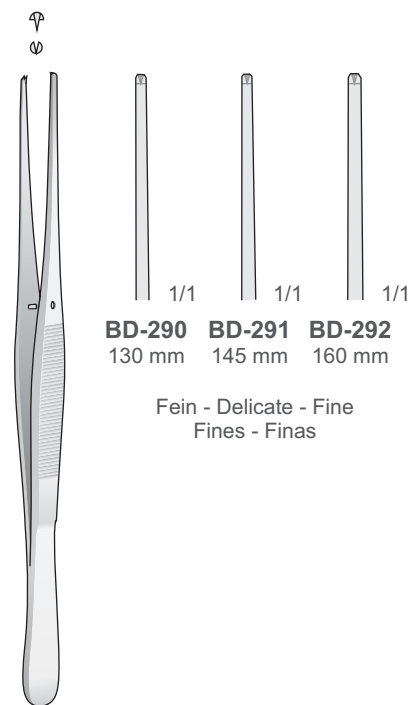

**BD-290**  
130 mm

**BD-291**  
145 mm

**BD-292**  
160 mm

Fein - Delicate - Fine  
Fines - Finas

**BD-290/BD-292**

Chirurgische pinzetten  
Tissue forceps  
Pinzette chirurgiche  
Pinzas quirúrgicas  
Pincas quirurgicales

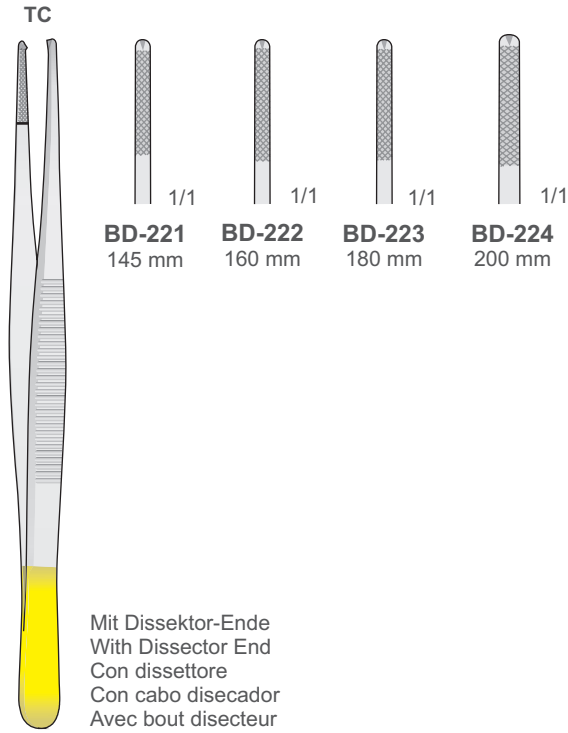

**BD-221/BD-224**

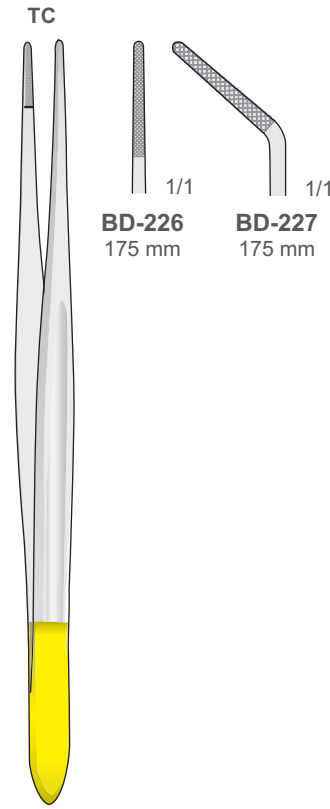

**CUSHING**  
**BD-226/BD-227**  
175 mm

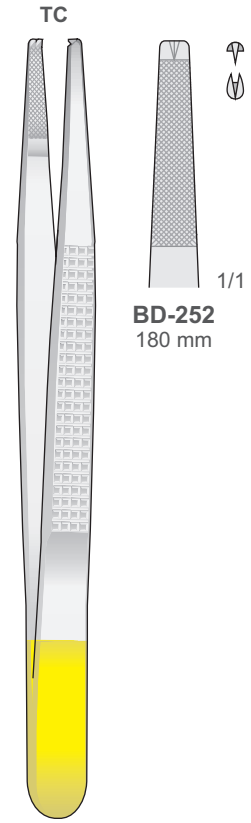

**BONNEY**  
**BD-252**  
180 mm

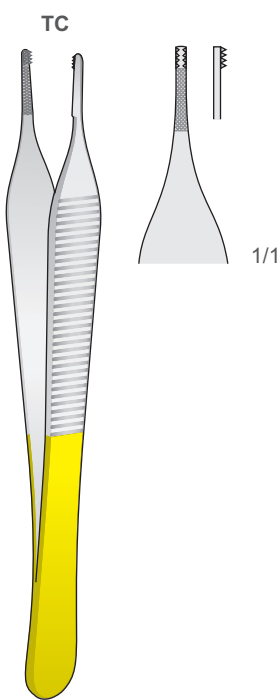

**ADSON-BROWN**  
**BD-253**  
120 mm

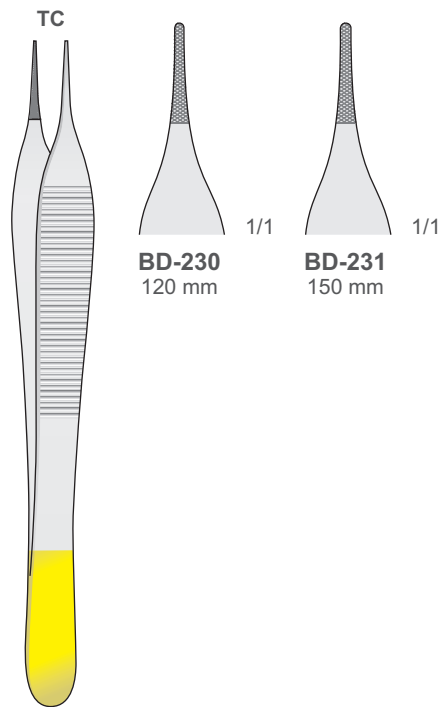

**ADSON**  
**BD-230/BD-231**

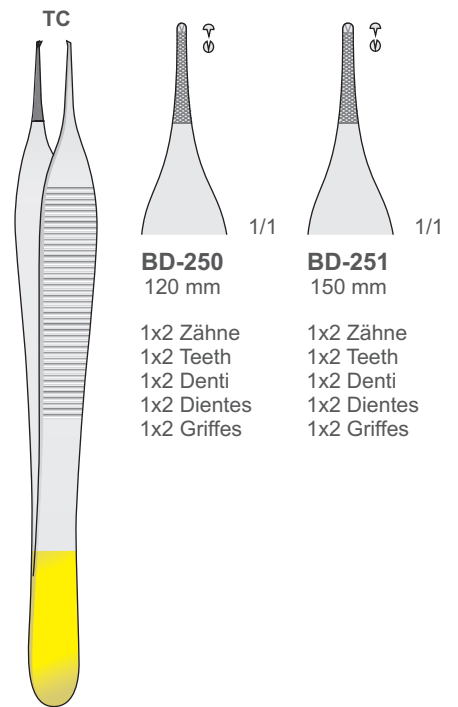

**ADSON**  
**BD-250/BD-251**

Mit Hartmetalleinsätzen  
Tungsten-carbide scissors  
Con punta al carburo di tungsteno  
Tijeras de tungsteno  
Avec plaquettes en carbure de tungstène

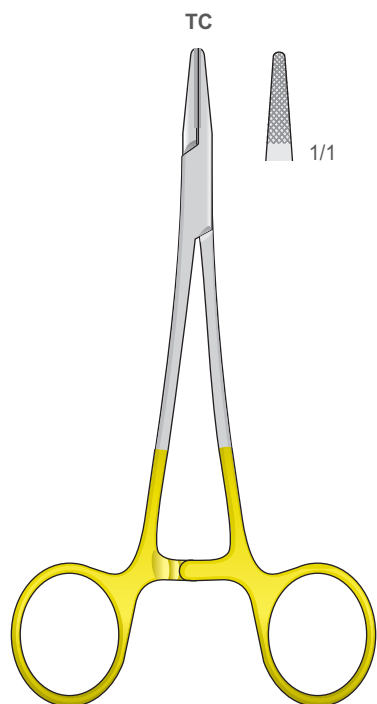

BABY-CRILE-WOOD  
**PH-54**  
150 mm

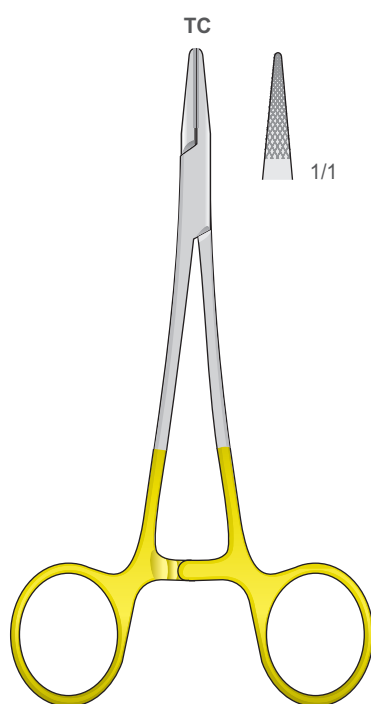

CRILE-WOOD  
**PH-71**  
150 mm

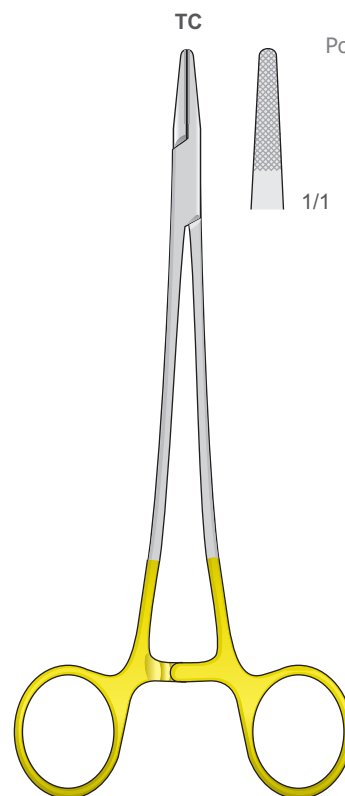

CRILE-WOOD  
**PH-77**  
180 mm

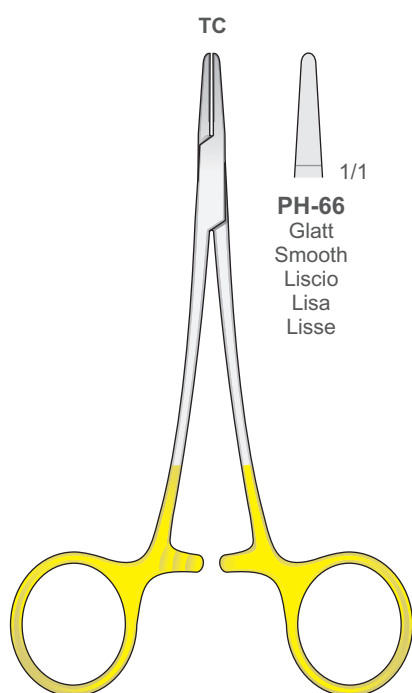

WEBSTER  
**PH-66**  
130 mm

**PH-66**  
Glatt  
Smooth  
Liscio  
Lisa  
Lisse

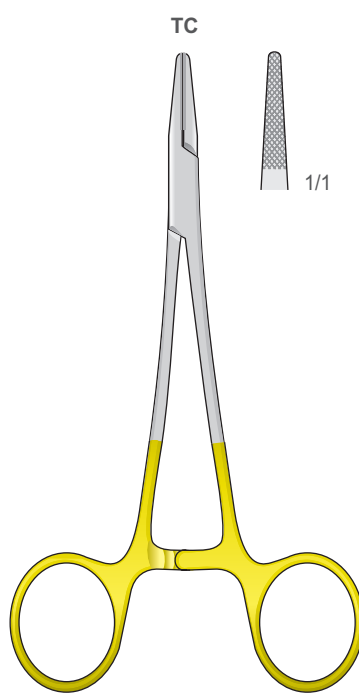

CONVERSE  
**PH-68**  
130 mm

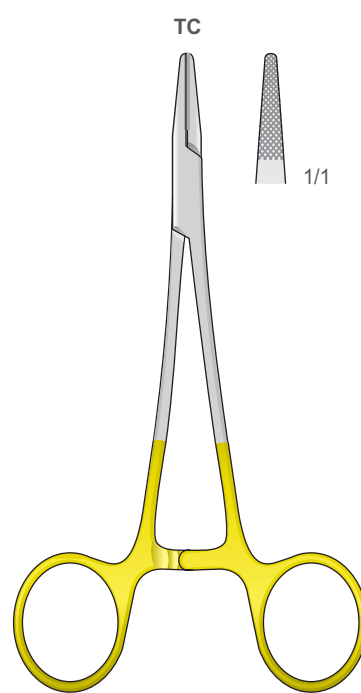

HALSEY  
**PH-73**  
130 mm

Nadelhalter  
Needle Holders  
Port'aghi  
Portaagujas  
Porte aiguilles

Mit Hartmetalleinsätzen  
Tungsten-carbide scissors  
Con punta al carburo di tungsteno  
Tijeras de tungsteno  
Avec plaquettes en carbure de tungstène

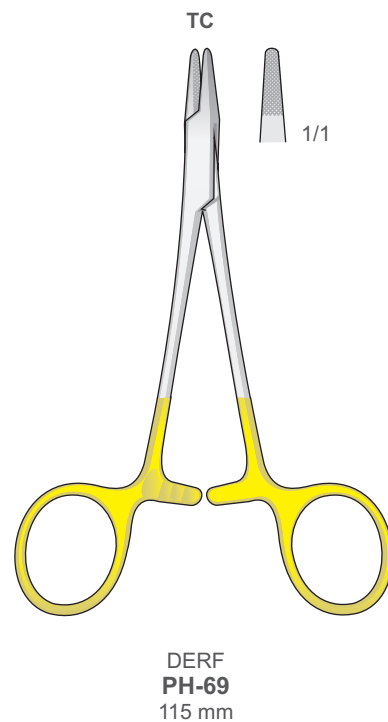
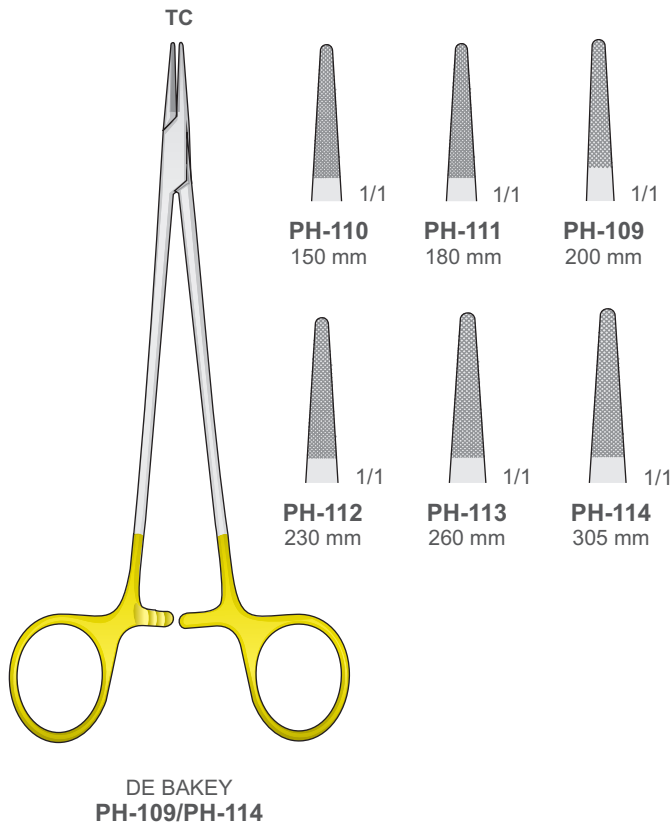
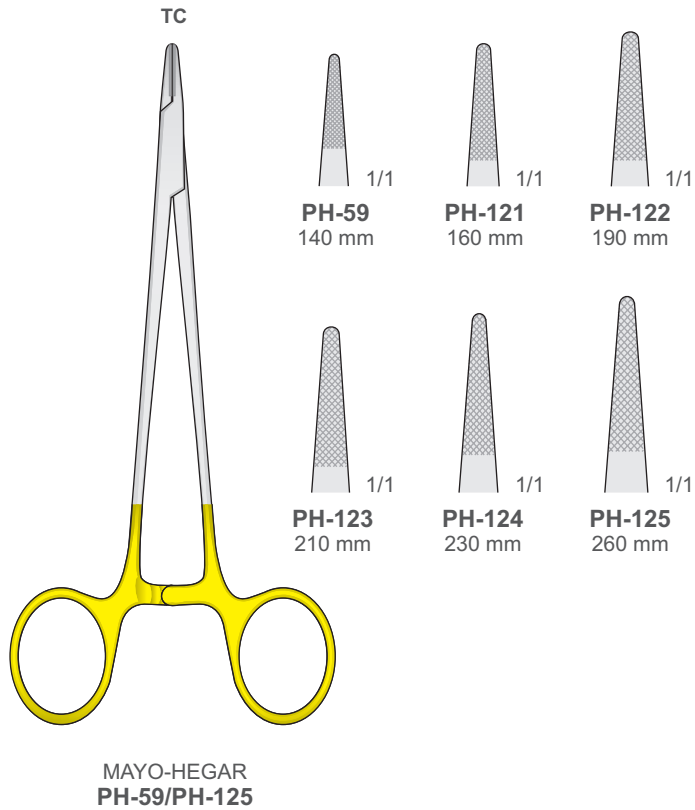

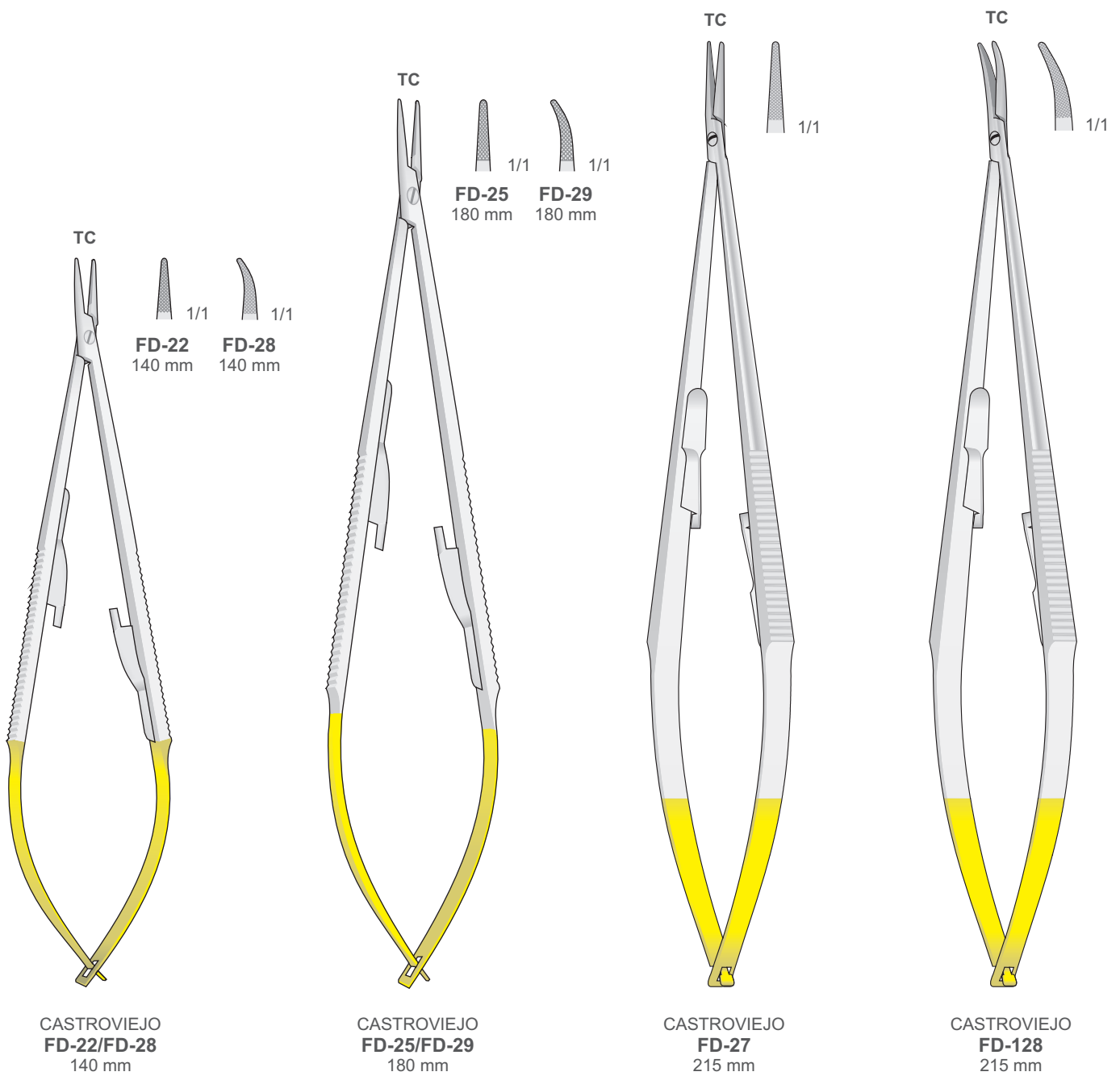

Arterienklemmen  
Hemostatic forceps  
Pinze emostatiche  
Pinzas hemostáticas  
Pincas hémostáticas

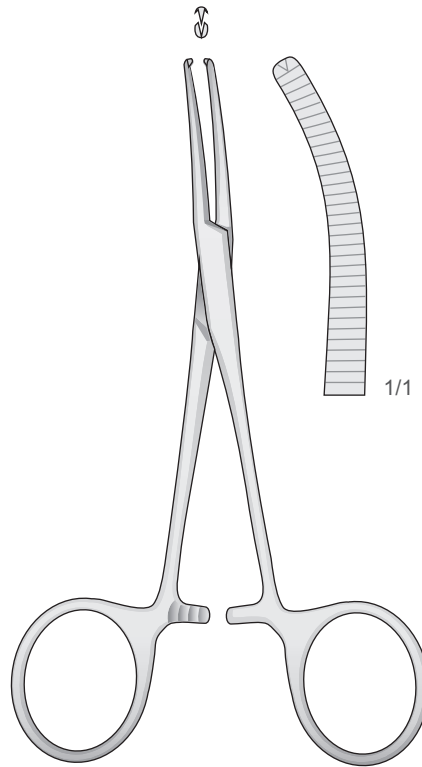

**P-76**  
180 mm

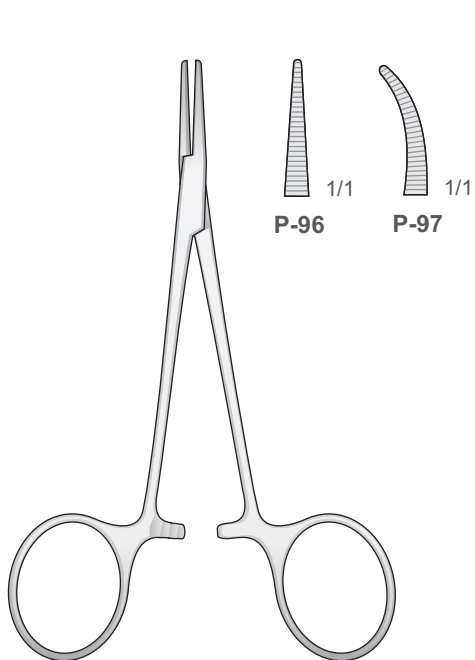

**HALSTED-MOSQUITO**  
**P-96/P-97**  
120 mm

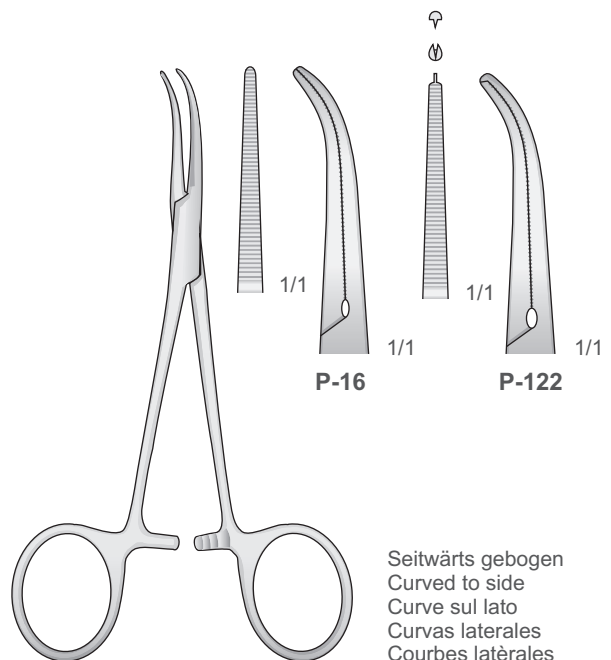

**DANDY**  
**P-16/P-122**  
140 mm

Seitwärts gebogen  
Curved to side  
Curve sul lato  
Curvas laterales  
Courbes latérales

Arterienklemmen  
Hemostatic forceps  
Pinze emostatiche  
Pinzas hemostáticas  
Pincés hémostatiques

Kopfschwartenzangen - Scalp Flap Forceps  
Pinze per il cuoio capelluto - Pinzas para el cuero cabelludo  
Pincés pour le cuir chevelu

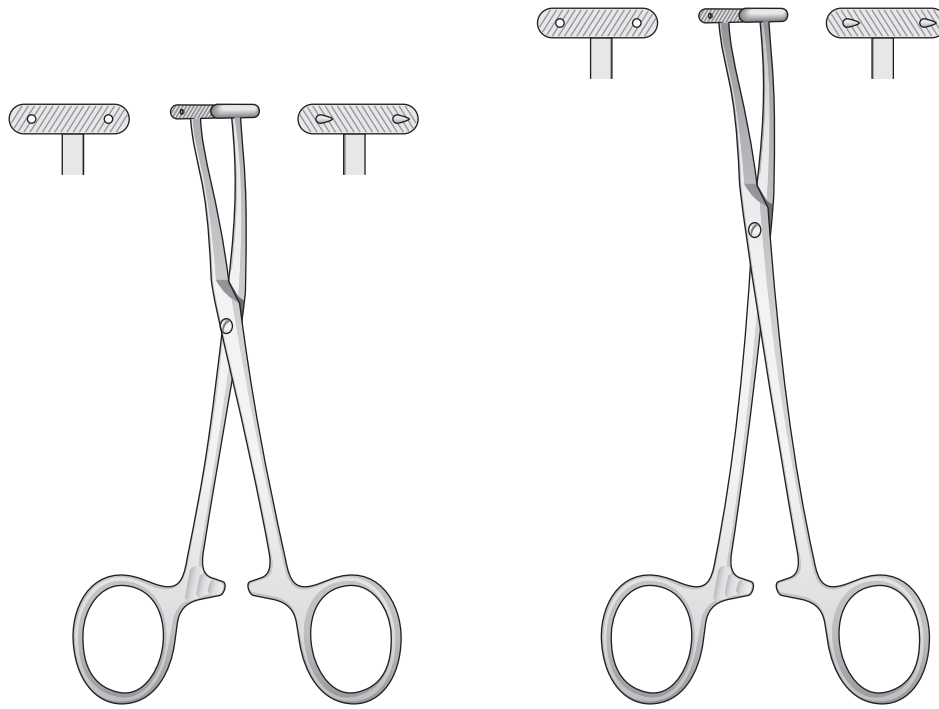

DE MARTEL  
**FB-119**  
140 mm

DE MARTEL  
**FB-120**  
180 mm

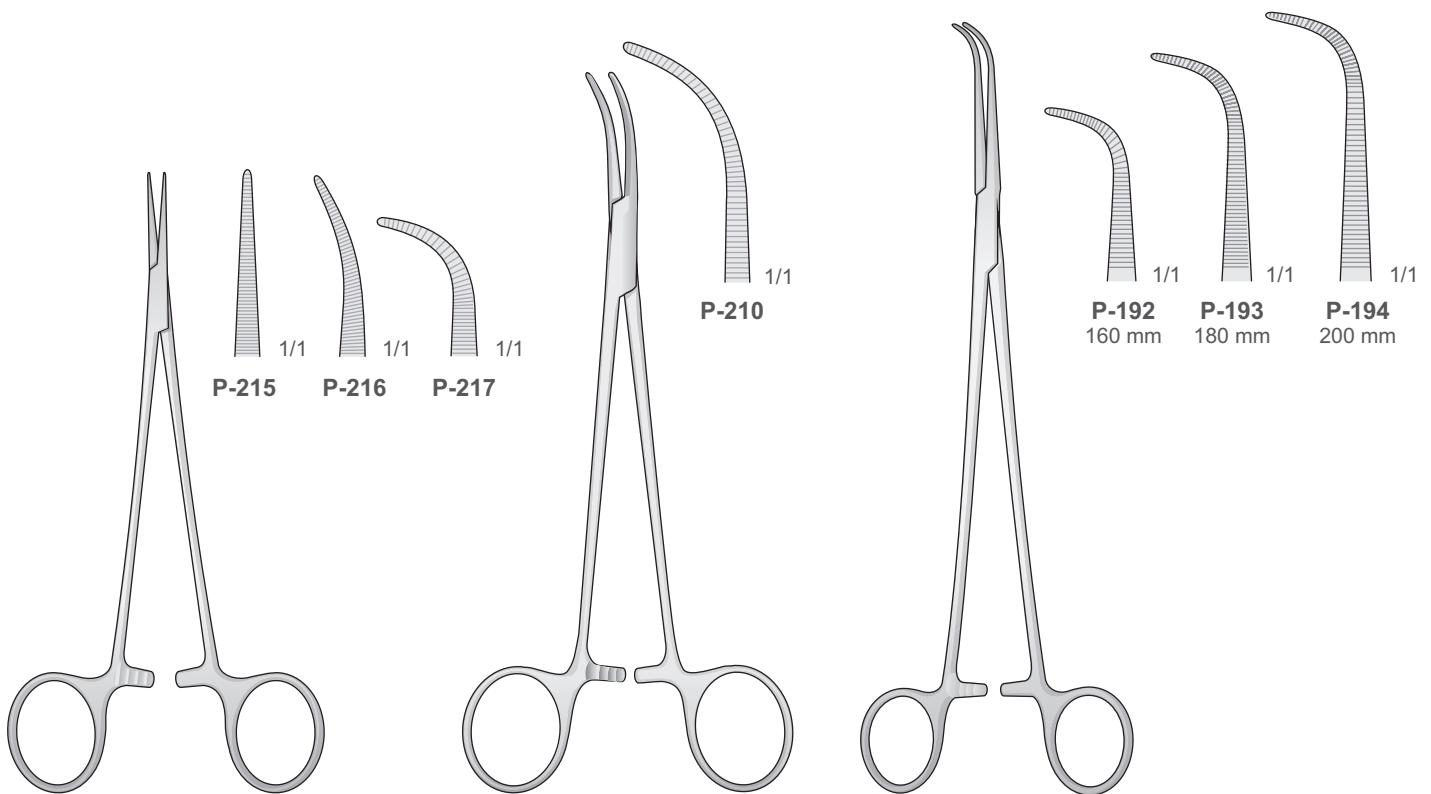

**P-215/P-217**  
160 mm

ROCHESTER-PEAN  
**P-210**  
180 mm

GEMINI  
**P-192/P-194**



Feine Wundhaken  
Delicate Retractors  
Divaricatori delicati  
Separadores finos  
Ecarteurs fins

Hauthäkchen - Cutaneous hook  
Uncini cutanei - Ganchos cutáneos  
Erignes cutanées

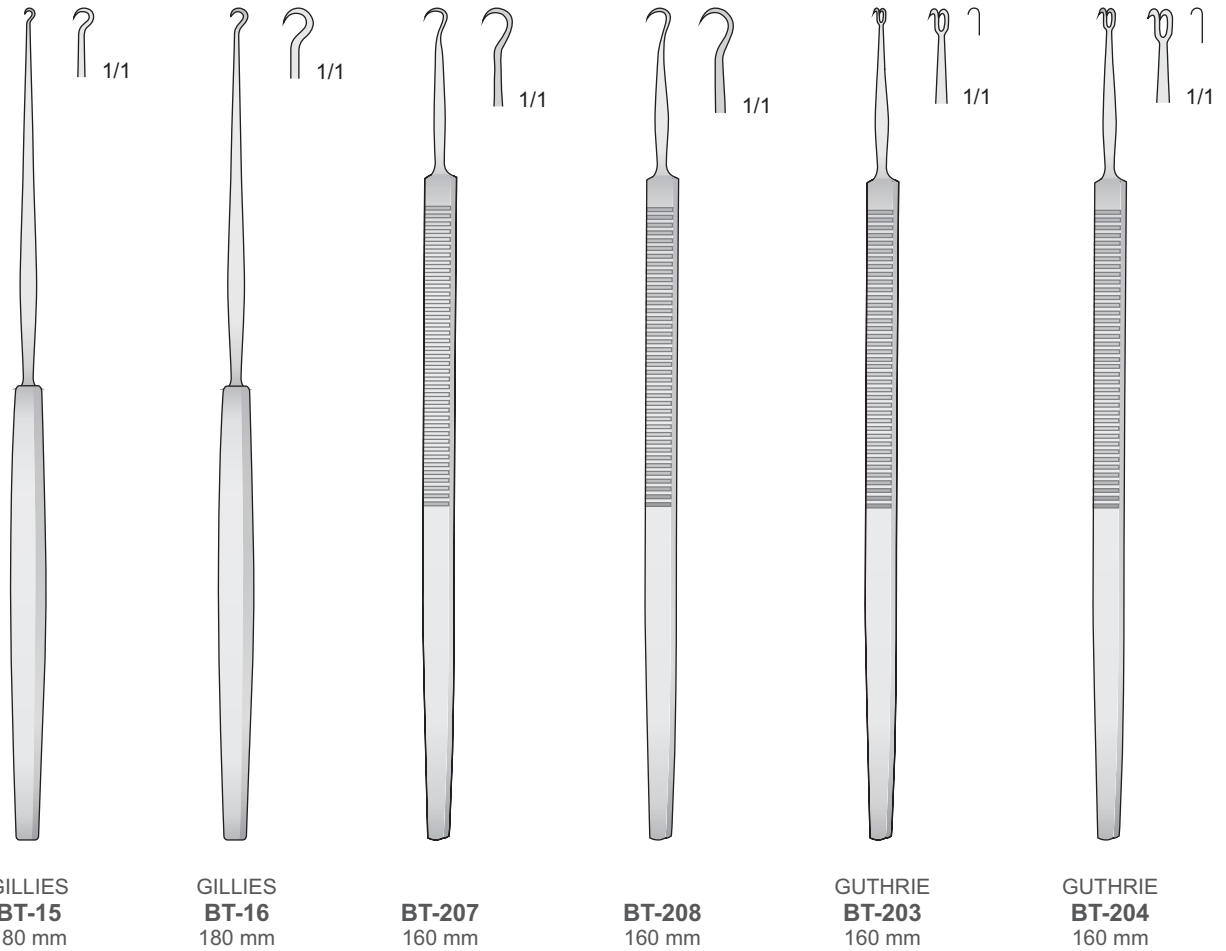

Feine Wundhaken  
Delicate Retractors  
Divaricatori delicati  
Separadores finos  
Ecarteurs fins

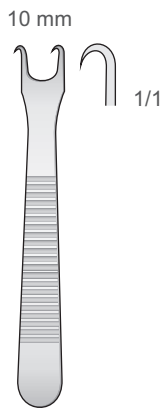
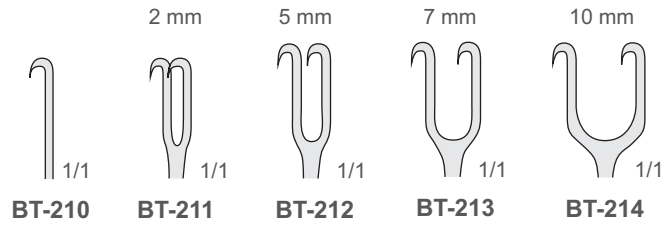

KILNER  
**BT-273**  
80 mm

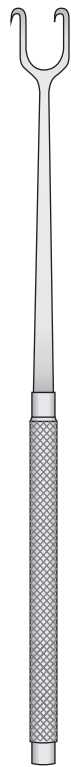

JOSEPH  
**BT-210/BT-214**  
160 mm

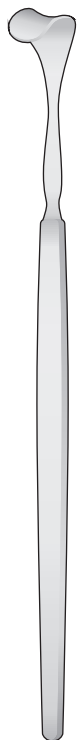
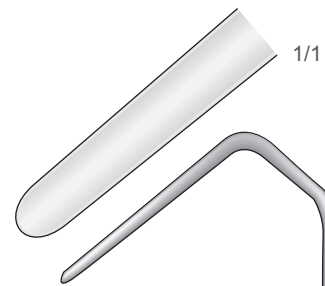

COTTLE  
**BT-245**  
150 mm

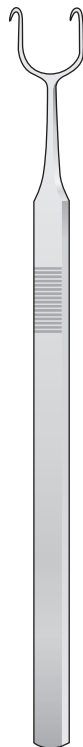

COTTLE  
**BT-215/BT-217**  
150 mm



**BT-215**

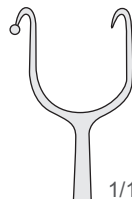

**BT-216**

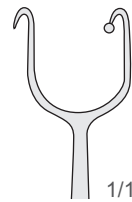

**BT-217**

Nasenhaken  
Nasal retractors  
Divaricatori nasali  
Separadores nasales  
Ecarteurs nasaux

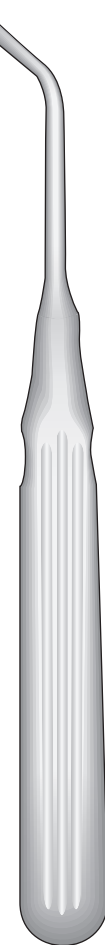

AUFRICHT  
**DO-48**  
175 mm

Weichteilhaken  
Soft tissue retractors  
Divaricatori per tessuti molli  
Separadores para partes blandas  
Ecarteurs pour parties molles

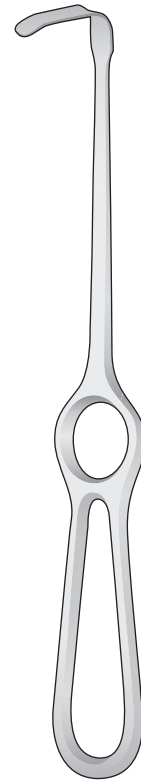
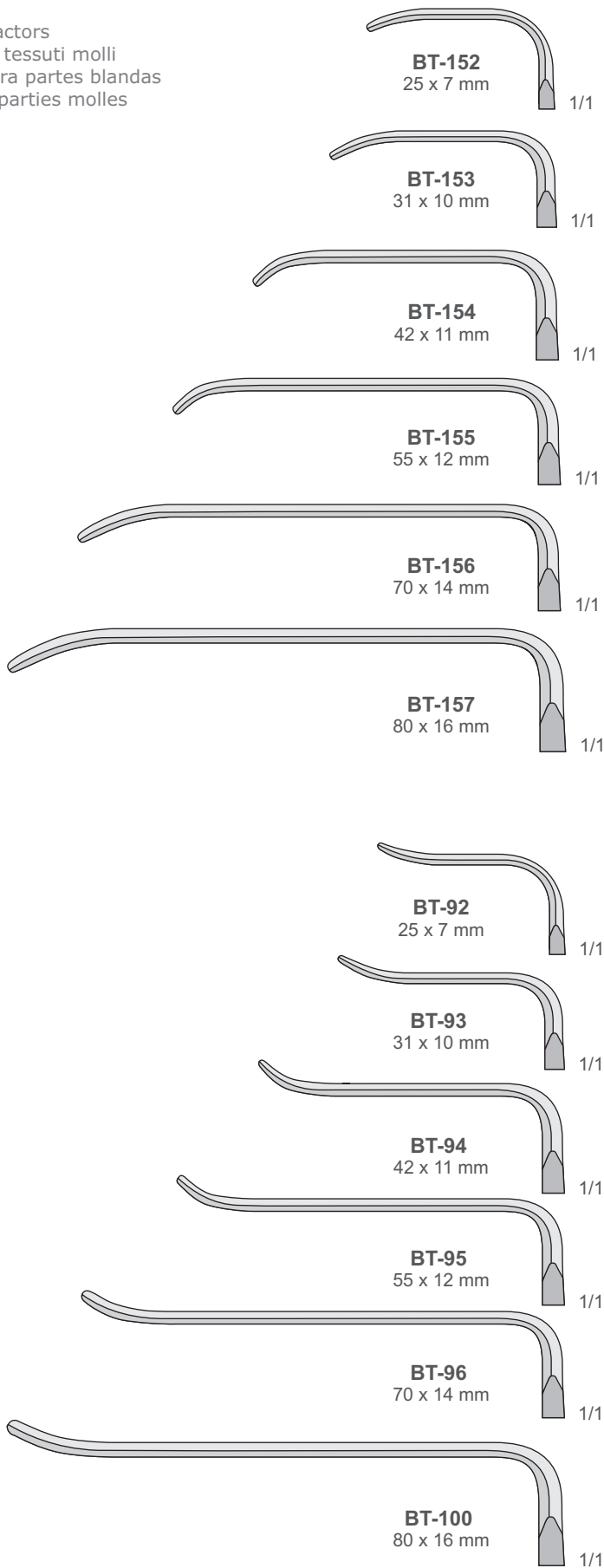

OBWEGESER  
BT-152/BT-157  
220 mm

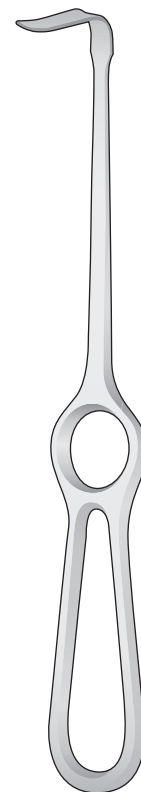

OBWEGESER  
BT-92/BT-100  
220 mm

Wangenhalter  
Cheek retractors  
Divaricatori di guance  
Separadores de mejillas  
Ecarteurs de joues

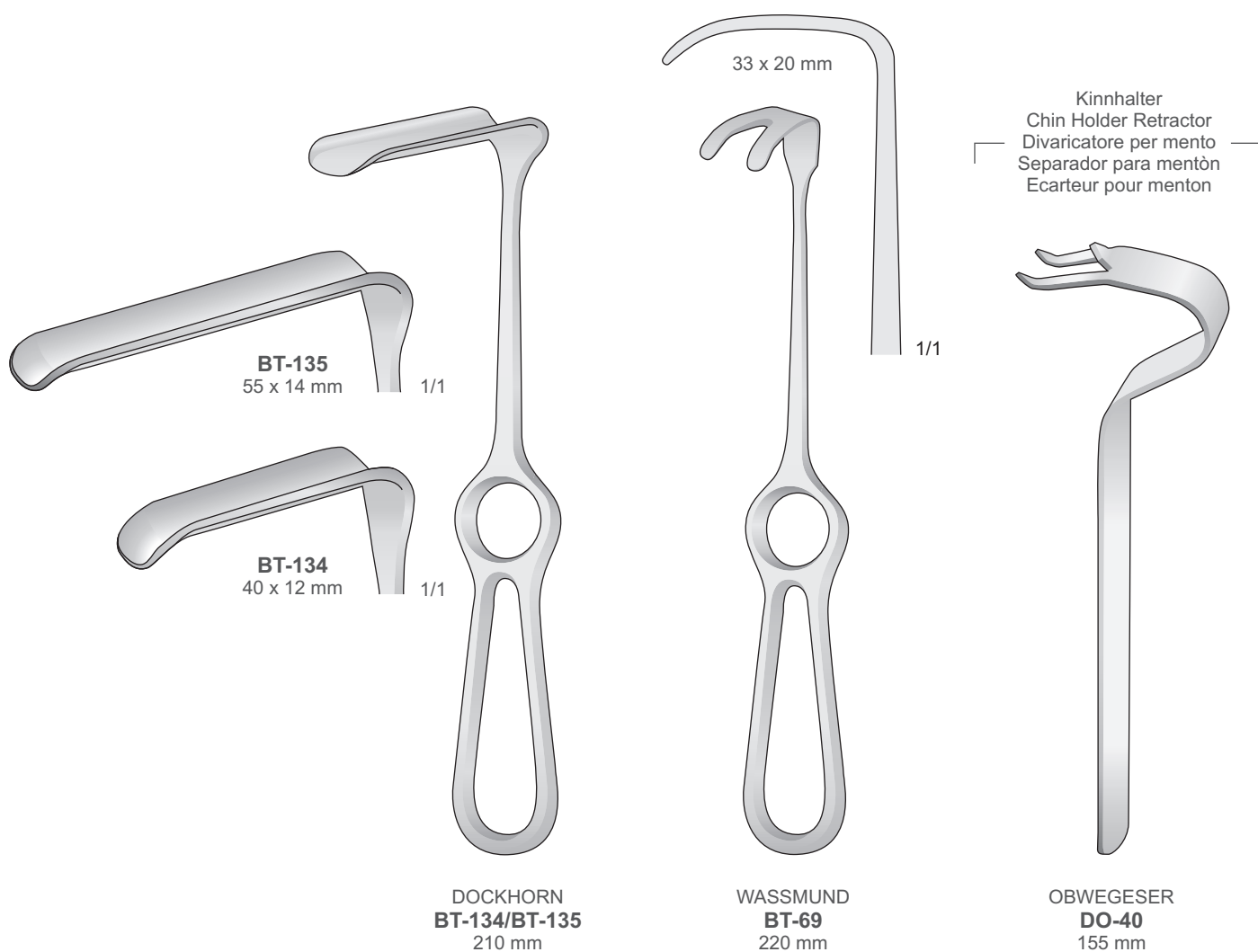

Wundhaken  
Retractors  
Divaricatori  
Separadores  
Ecarteurs

Spina Nasalis-haken  
Nasal spine Retractor  
Separatore per spina nasale  
Separador para spina nasalis  
Ecarteur pour spina nasalis



42 x 10 mm

1/1



70 x 11 mm

1/1

25 x 6 mm

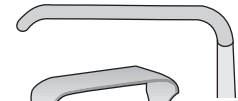

1/1

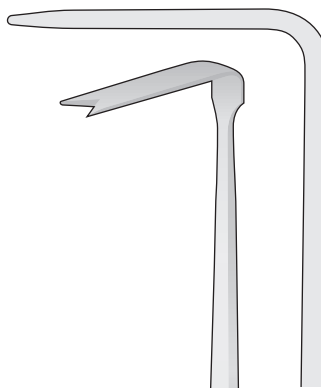

1/1

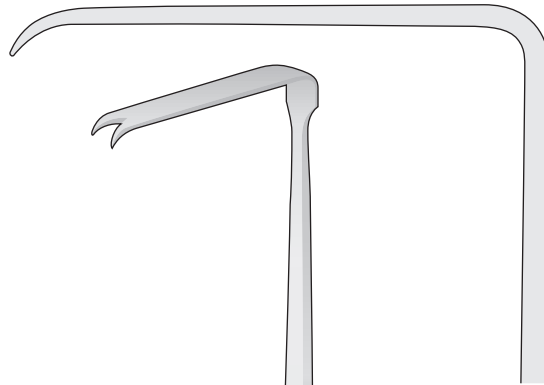

1/1

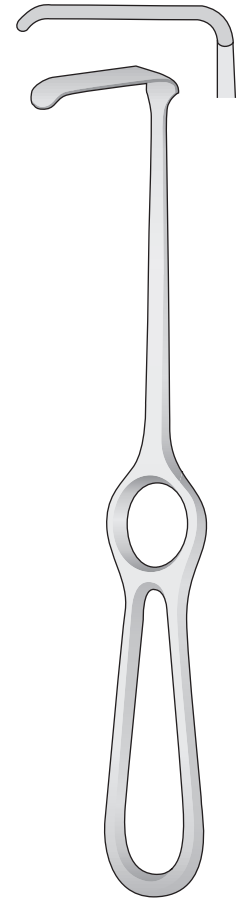

**OBWEGESER**  
**BT-67**  
215 mm

**RAMUS RETRACTOR**  
**BT-68**  
220 mm

**KOCHER-LANGENBECK**  
**BT-60**  
215 mm

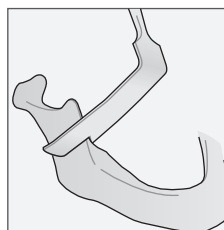

Ramus Retraktoren Rechts  
Ramus Retractor Right  
Retrattore Ramus destro  
Separadores Ramus derecho  
Ecarteur Ramus droites

Ramus Retraktoren Links  
Ramus Retractor Left  
Retrattore Ramus sinistro  
Separadores Ramus izquierdo  
Ecarteur Ramus gauches

Progenierinnen  
Mandibular Channel Retractors  
Separatori mandibolari  
Separadores mandibulares  
Ecarteurs mandibulaires

8 mm

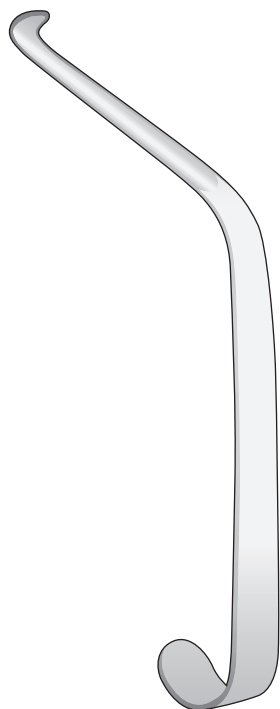

OBWEGESER  
**DO-41**  
165 mm

10 mm

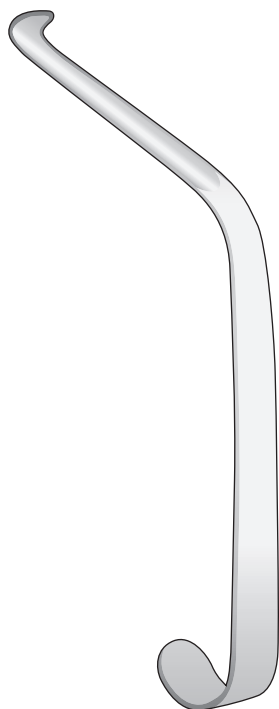

OBWEGESER  
**DO-142**  
165 mm



MISCH  
**BT-158**  
210 mm



MISCH  
**BT-159**  
210 mm

Wundhaken  
Retractors  
Divaricatori  
Separadores  
Ecarteurs

Intraorale Retraktoren  
Intraoral retractors  
Separatori intraorali  
Separadores intra orales  
Rétracteurs intra-oraux

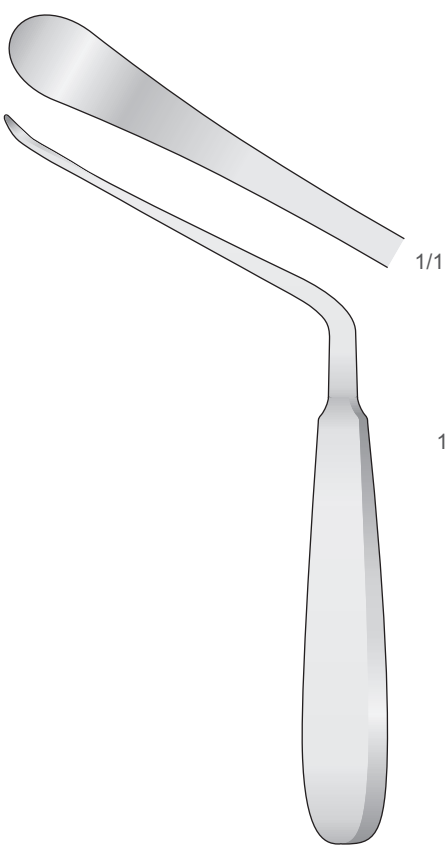

**DO-125**  
210 mm

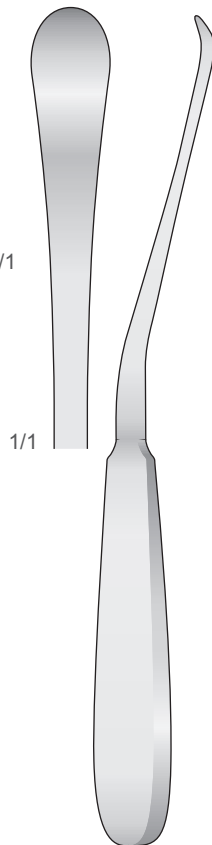

**DO-126**  
235 mm

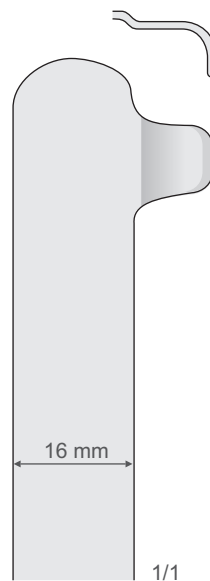

**DO-45**

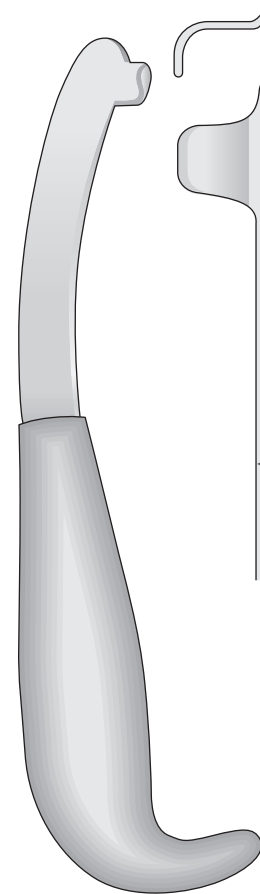

**DO-46**

SIGMOID NOTCH  
**DO-45/DO-46**  
240 mm

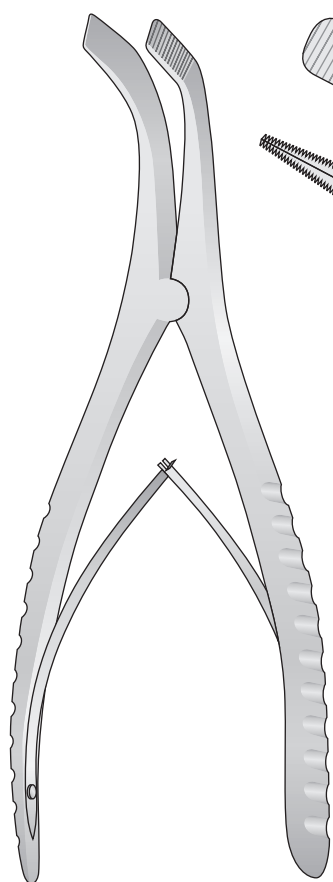
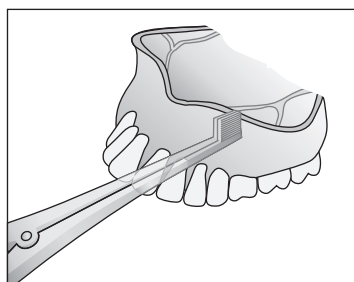

TESSIER  
**DO-19**  
180 mm

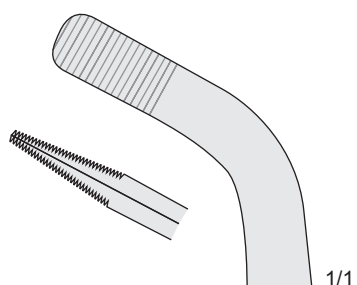

1/1

Spreizzange  
Spreading forceps  
Pinze per divaricare  
Pinza de expansion  
Pince à écarter

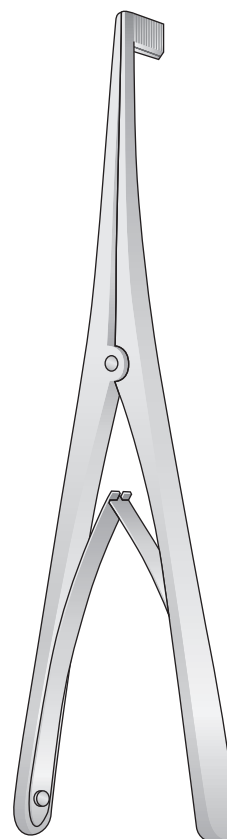

**DO-29**  
170 mm

Palatum Spreizer  
Palatal expander  
Separatore per palato  
Separador paladial  
Ecarteur pour  
ostéotomie palatine



Knochen-Spreizer  
Bone Separator  
Separatore osseo  
Separadores de hueso  
Ecarteurs à os

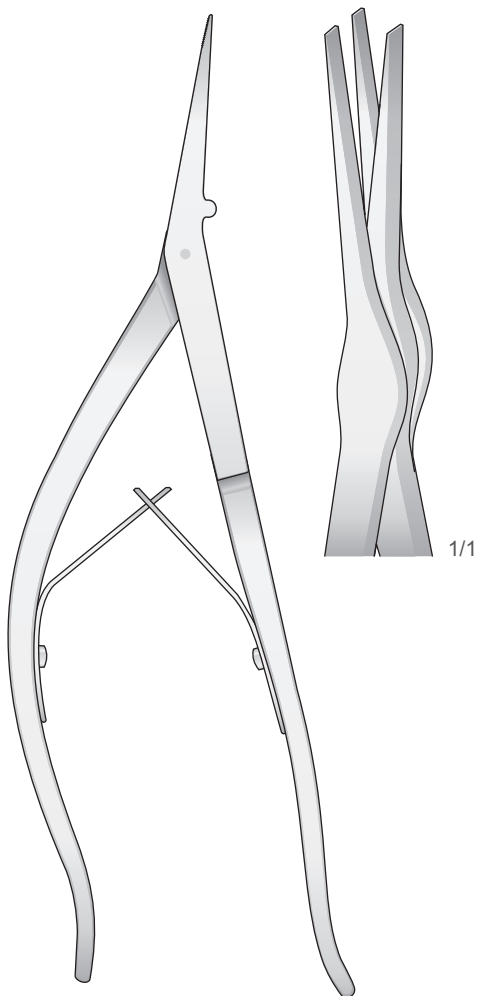
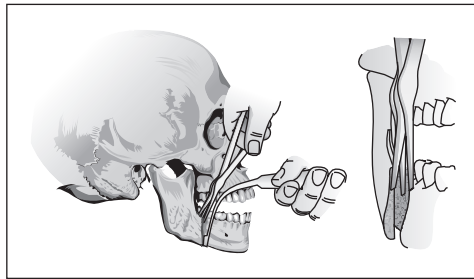

RAMUS  
**DO-247**  
230 mm

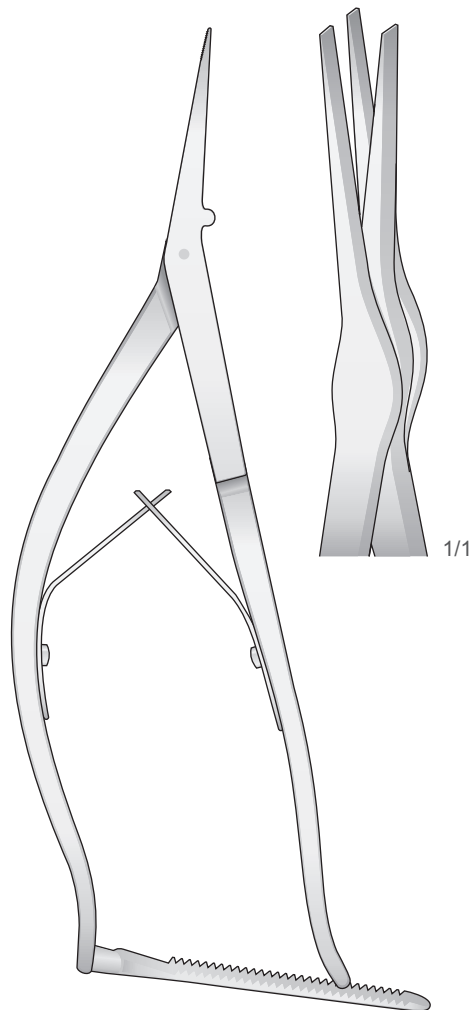

RAMUS  
**DO-248**  
230 mm

Beckenkamm Spatel  
Iliac Crest Retractors  
Divaricatori per cresta iliaca  
Separadores para cresta iliaca  
Rétracteur iliaque

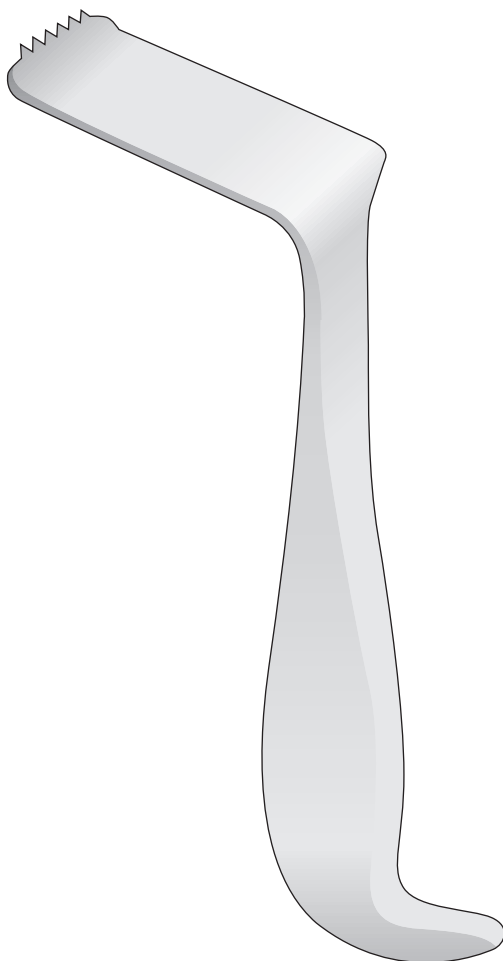

TESSIER  
**BT-220/BT-223**  
180 mm

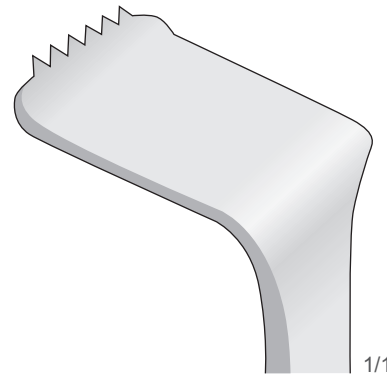

1/1  
**BT-220**  
36 X 50 mm

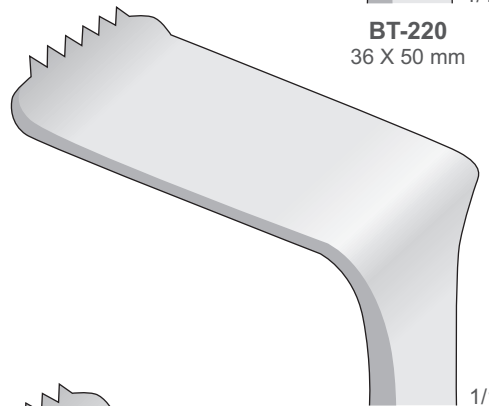

1/1  
**BT-221**  
52 X 50 mm

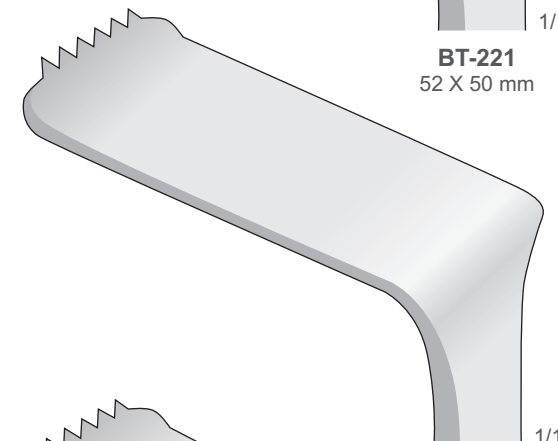

1/1  
**BT-222**  
59 X 50 mm

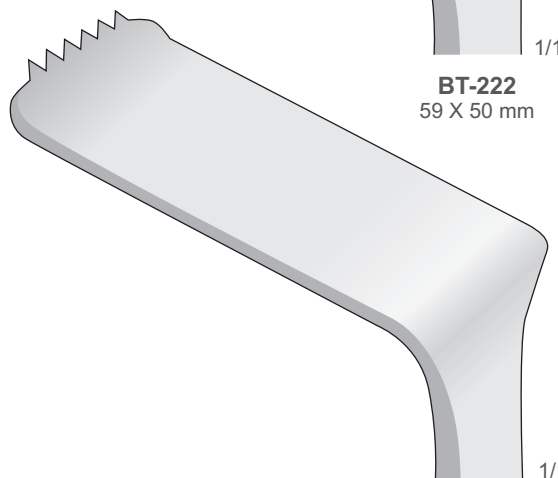

1/1  
**BT-223**  
66 X 50 mm

Elevatorium, Raspatorien  
Elevator, Raspatories  
Elevatori, Periostotomi  
Elevador, Legras  
Elévateur, Rugines

Septum Elevatorien  
Periosteal Elevators  
Elevatori per il setto nasale  
Elevadores para el tabique nasal  
Elévateurs pour cloison nasale

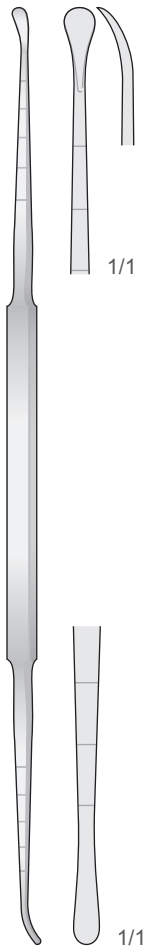

**COTTLE  
DO-60**  
220 mm

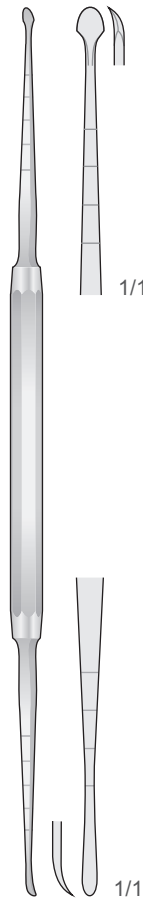

**MASING  
DO-47**  
210 mm

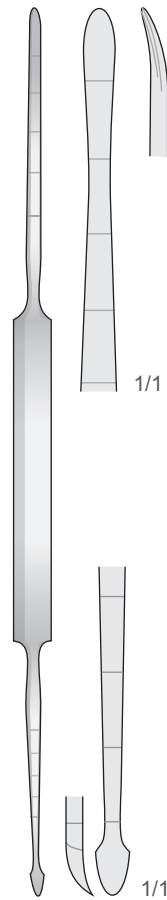

**COTTLE  
DO-111**  
210 mm

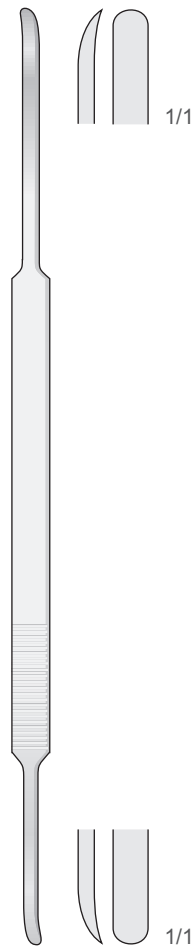

**MCKENTY  
KO-46**  
220 mm

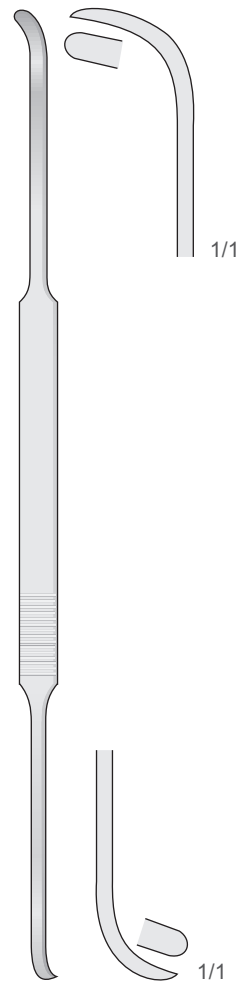

**COTTLE  
KO-12**  
230 mm

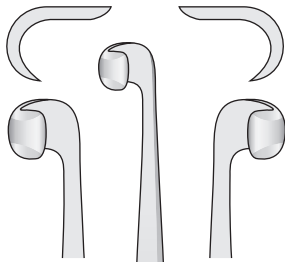

**DO-68**

Links, Scharf  
Left, sharp  
Sinistra, tagliente  
A la izquierda, cortante  
À gauche, tranchant

**DO-69**

Rechts, Scharf  
Right, sharp  
Destra, tagliente  
A la derecha, cortante  
À droite, tranchant



Unterkieferrand  
Raspatorien  
Mandibular inferior  
border Raspatories  
Staccaperiosteo per  
bordo mandibolare  
Legras para  
el borde mandibular  
Rugine - Raspatoires  
pour le bord mandibulaire

OBWEGESER  
**DO-68/DO-69**  
190 mm

Für Jochbögen  
For Zygomatic Archs  
Per arco zigomatico  
Para arcos cigomáticos  
Pour arcades cygomatiques

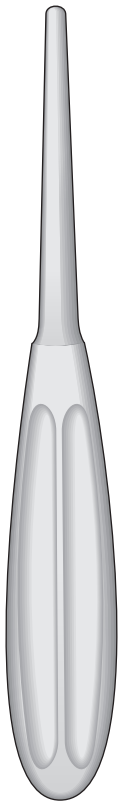

GOLDMANN  
**DO-288**  
200 mm



DINGMANN  
**DO-291**  
210 mm

Dingmann  
Zygoma Elevator

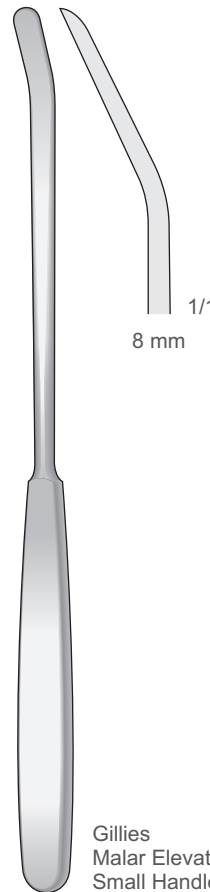

GILLIES  
**DO-28**  
235 mm

Gillies  
Malar Elevator,  
Small Handle

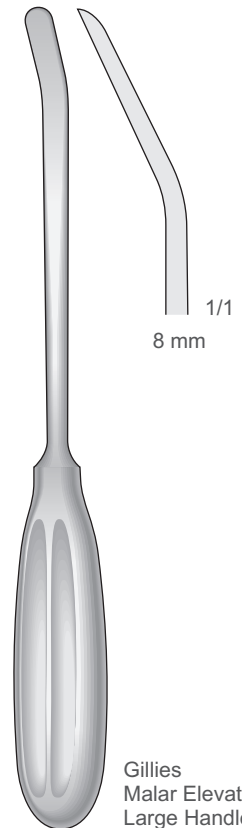

GILLIES  
**DO-128**  
210 mm

Gillies  
Malar Elevator,  
Large Handle

Wundhaken  
Retractors  
Divaricatori  
Separadores  
Ecarteurs

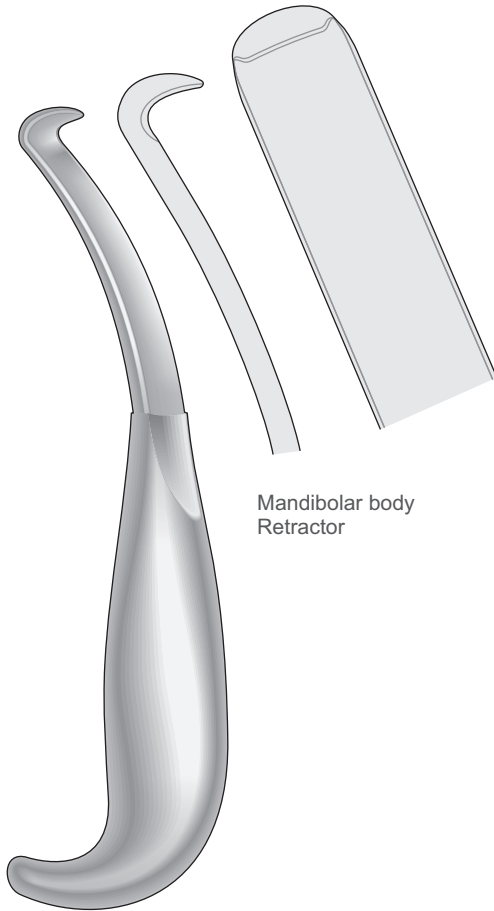

Mandibular body  
Retractor

HARGIS  
**DO-283**  
180 mm

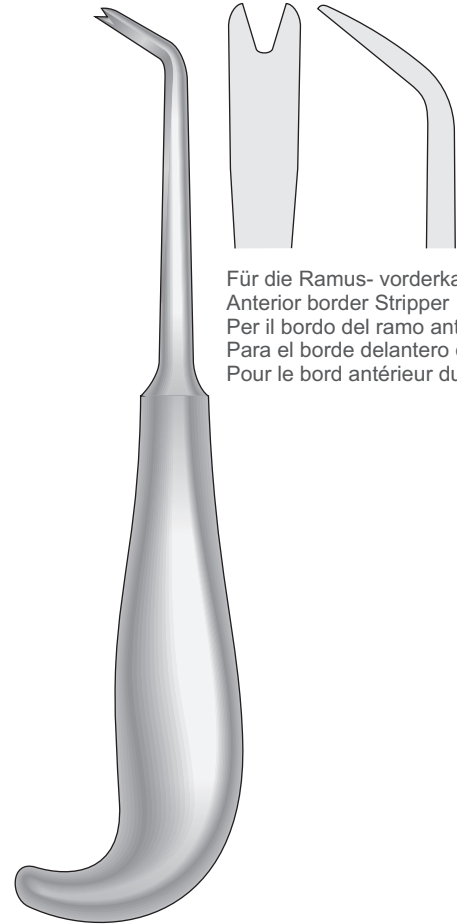

Für die Ramus- vorderkante  
Anterior border Stripper  
Per il bordo del ramo anteriore  
Para el borde delantero del ramus  
Pour le bord antérieur du rameau

HARGIS  
**DO-284**  
190 mm

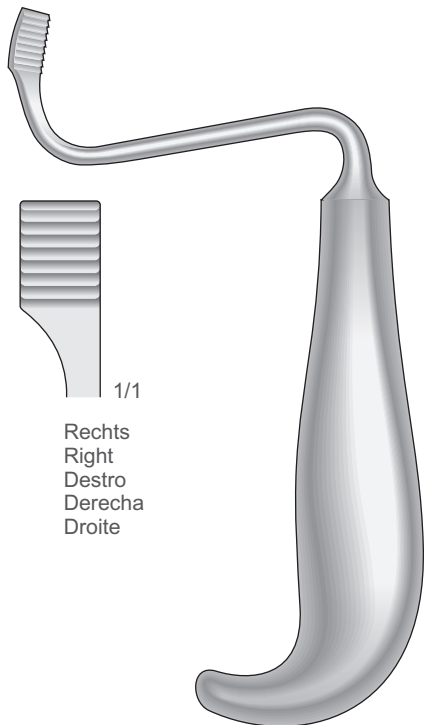

1/1  
Rechts  
Right  
Destro  
Derecha  
Droite

Für Unterkiefer  
Retro maxillary Levers  
Per mandibole  
Para mandibulas  
Pour maxillaires

TESSIER  
**DO-42**  
150 mm

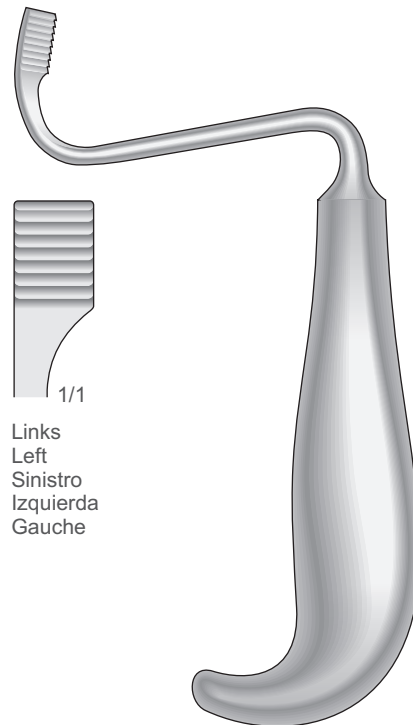

1/1  
Links  
Left  
Sinistro  
Izquierda  
Gauche

Für Unterkiefer  
Retro maxillary Levers  
Per mandibole  
Para mandibulas  
Pour maxillaires

TESSIER  
**DO-43**  
150 mm

Raspatorien - Flach Angeschliffen  
Periosteal elevators - Flat cutting  
Elevatori periostali - Affilatura piana  
Legras - Biselado plano  
Rugines - Raspatoires - Tranchant plat

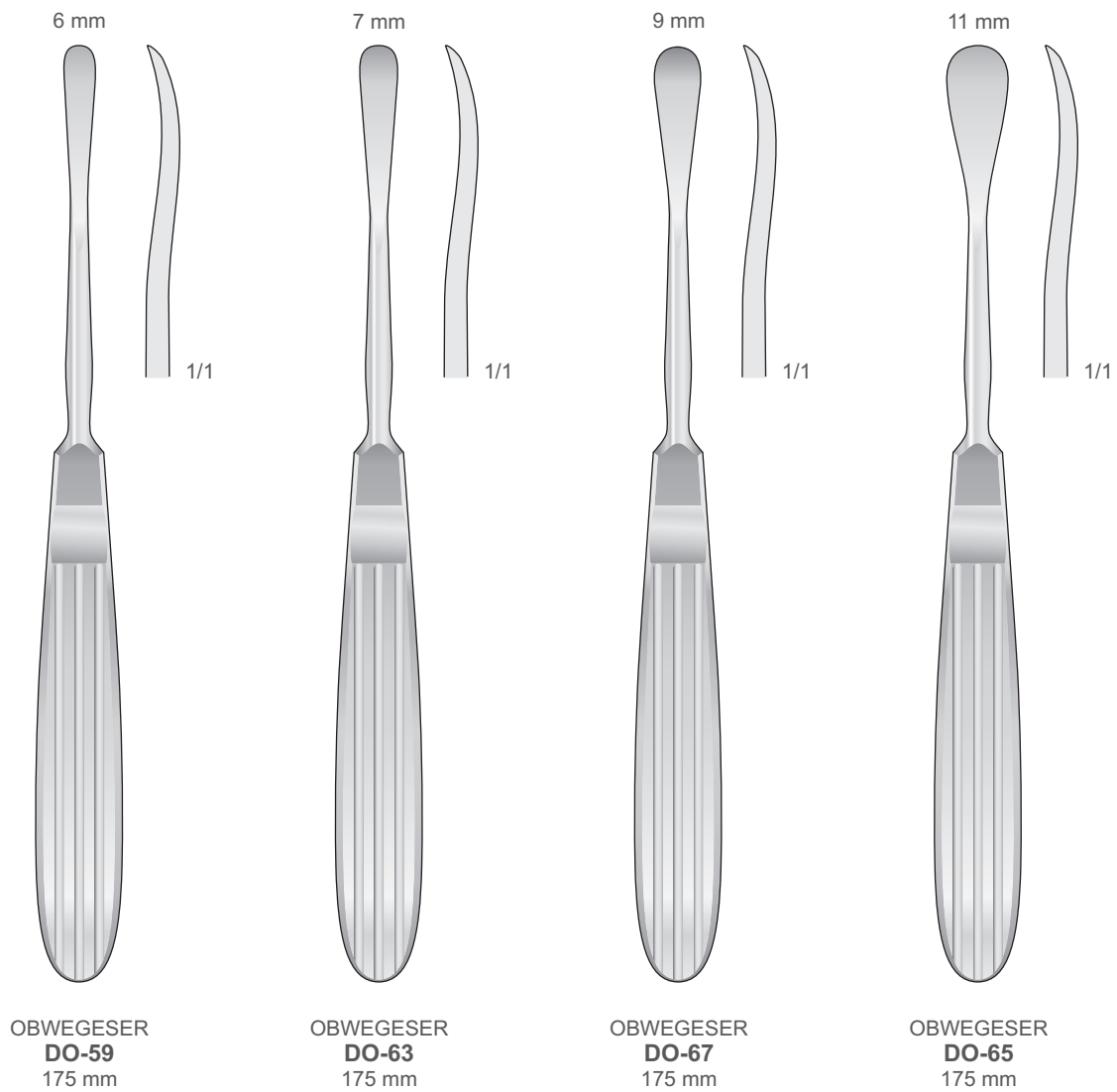

Raspatorien  
Raspatories  
Periostotomi  
Legras  
Rugines

Ramus Raspatorien  
Ramus Periosteal elevators  
Periostotomi Ramus  
Legras para Ramus  
Rugines - Raspatoires pour Ramus

Taglienti - Sharp  
Scharf - Tranchant - Cortante

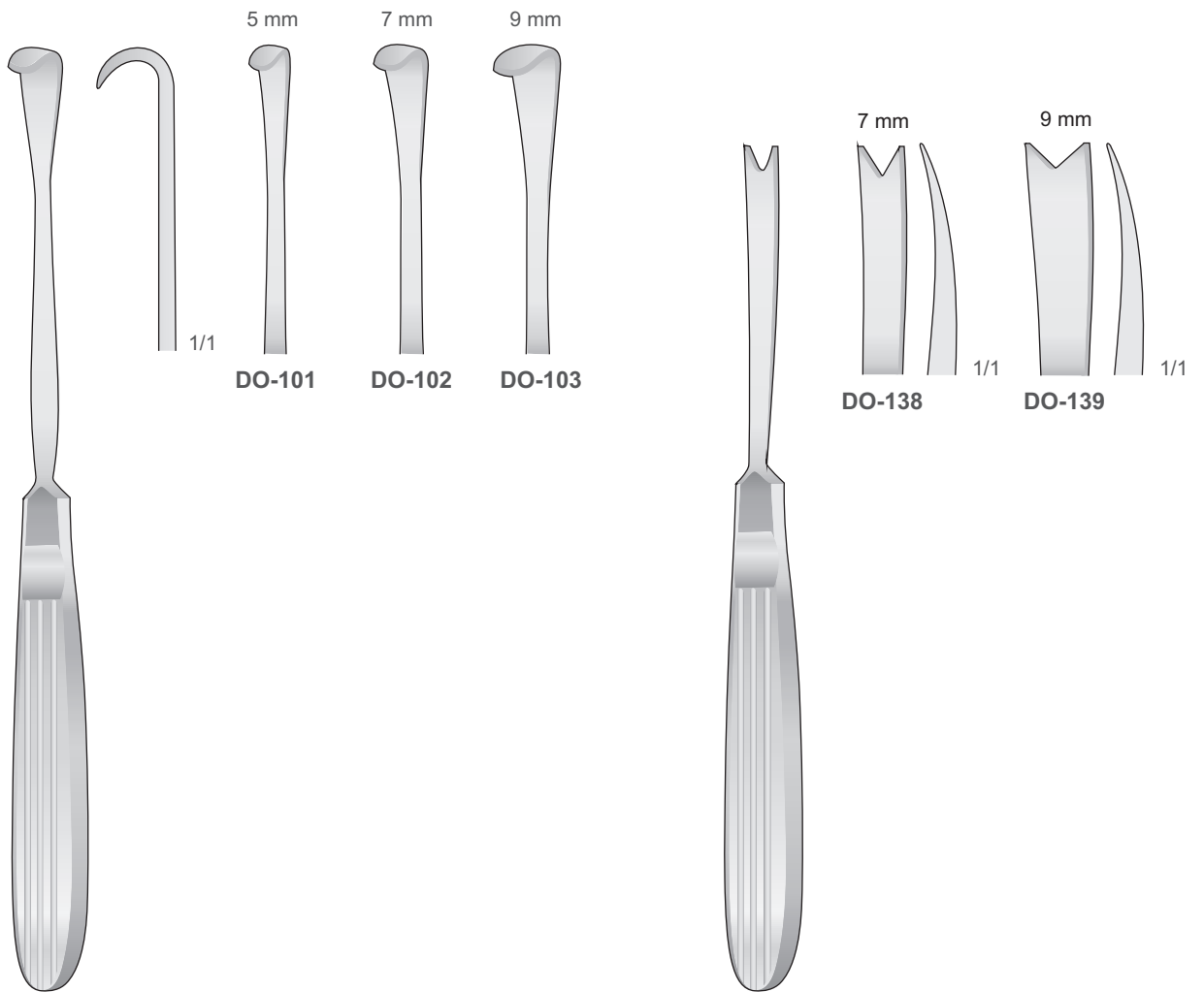

OBWEGESER  
**DO-101/DO-103**  
200 mm

OBWEGESER  
**DO-138/DO-139**  
175 mm

Raspatorien  
Raspatories  
Periostotomi  
Legras  
Rugines

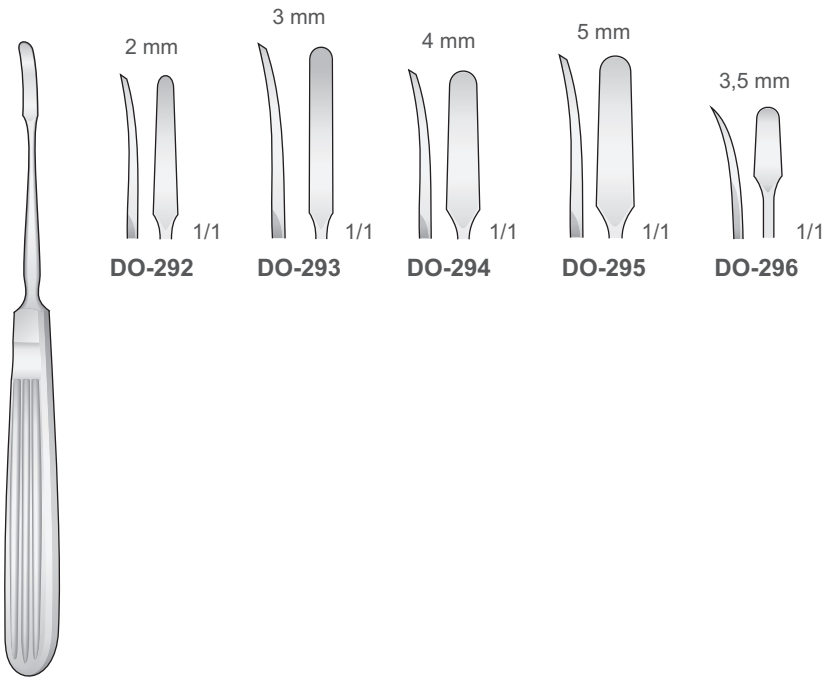

2 mm  
DO-292

3 mm  
DO-293

4 mm  
DO-294

5 mm  
DO-295

3,5 mm  
DO-296

WALTON  
DO-292/DO-296  
160 mm

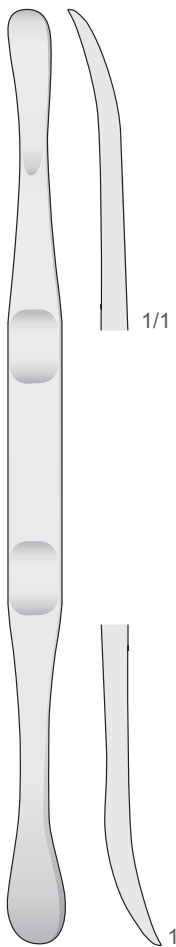

BABBUSH  
KO-20  
180 mm

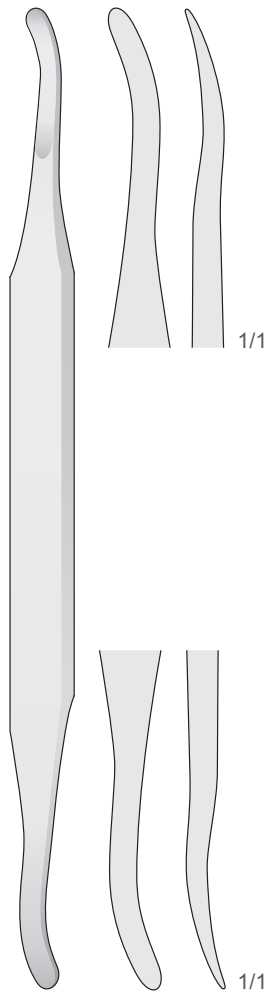

SELDIN  
KO-22  
190 mm

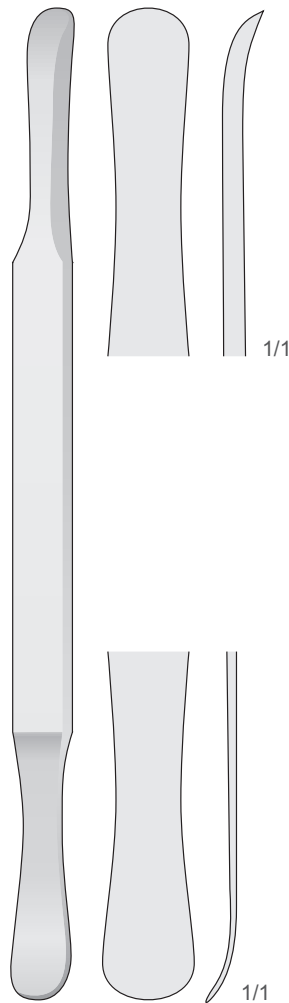

SELDIN  
KO-23  
195 mm

Elevatorium Stumpf - Elevators Blunt  
Elevatori smussi - Elevadores romo  
Elévateurs mousse

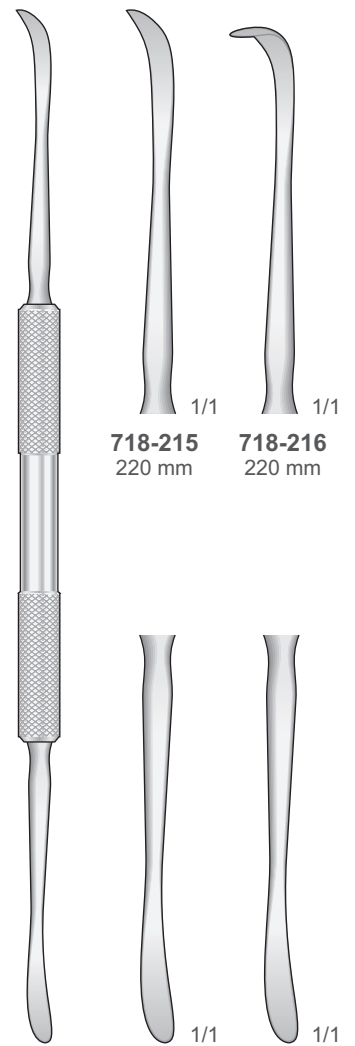

718-215  
220 mm

718-216  
220 mm

OBWEGESER-FREER  
718-215/718-216  
220 mm



Raspatorien  
Raspatories  
Periostotomi  
Legras  
Rugines

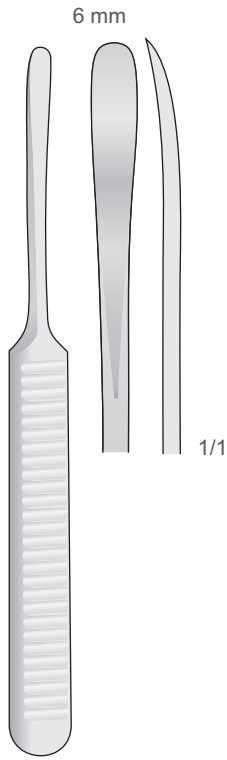

**WILLIGER  
WG-12**  
160 mm

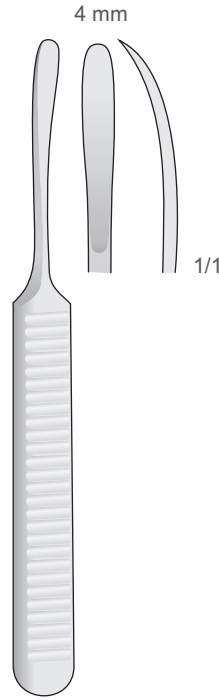

**WILLIGER  
WG-14**  
140 mm

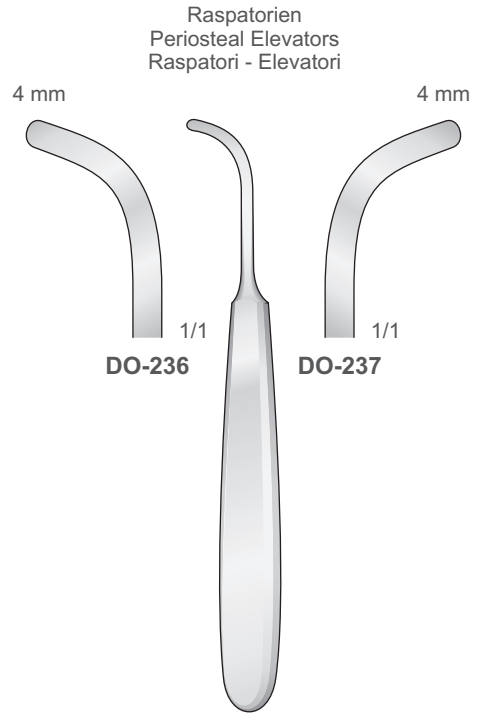

**DO-236/DO-237**  
140 mm



**CHOMPRET  
CH-1**  
165 mm



**CHOMPRET  
CH-2**  
165 mm



**CHOMPRET  
CH-3**  
165 mm

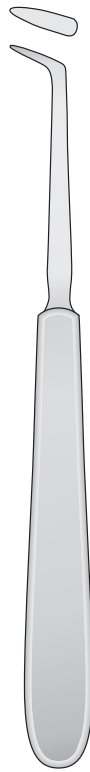

**CHOMPRET  
CH-4**  
160 mm

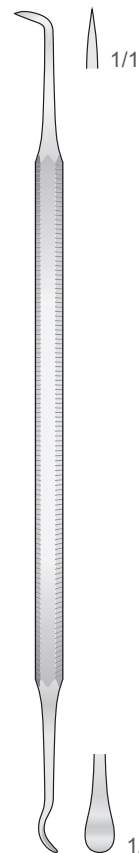

**MITCHEL  
AT-12**  
170 mm

Fig. 12S



**BENNETT  
KO-58**  
175 mm



**MOLT  
718-M9**  
170 mm

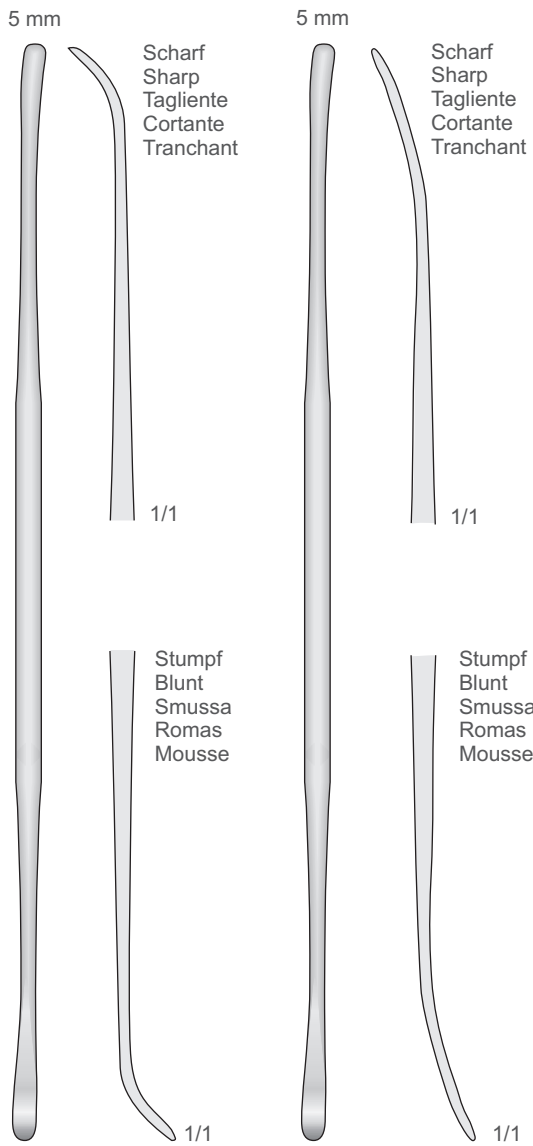

**SALZBURG**  
**DO-240**  
245 mm

**SALZBURG**  
**DO-241**  
245 mm

Sinus Lift Küretten - Sinus Lift Curettes  
Curette per sinus lift - Curetas para sinus lift  
Curettes pour sinus lift

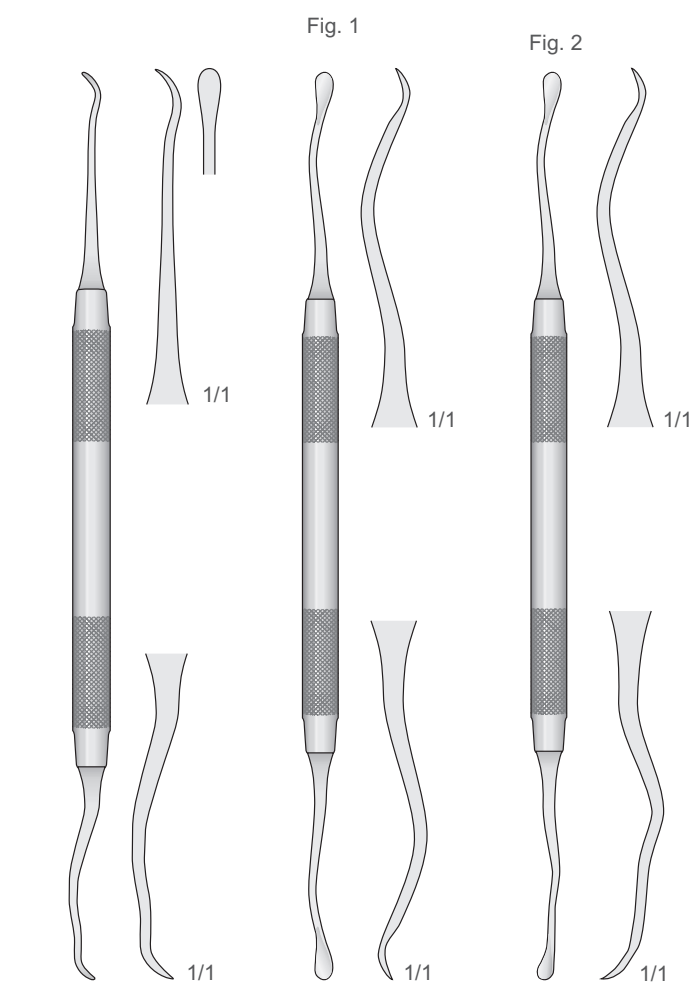

**MILLER-COLBURN**  
**CU-MC1**  
180 mm

**SINUS**  
**SL-1**  
180 mm

**SINUS**  
**SL-2**  
180 mm

Sinus Lifting Elevatorien  
Sinus Lifting Elevators  
Elevatori per Sinus Lifting  
Elevadores para Sinus Lift  
Elévateurs pour Sinus Lift

Sinus Lift Instrumente - Sinus Lift Instruments  
Strumenti per rialzo del seno - Instrumentos para elevación de senos  
Instruments pour les soulevés de sinus

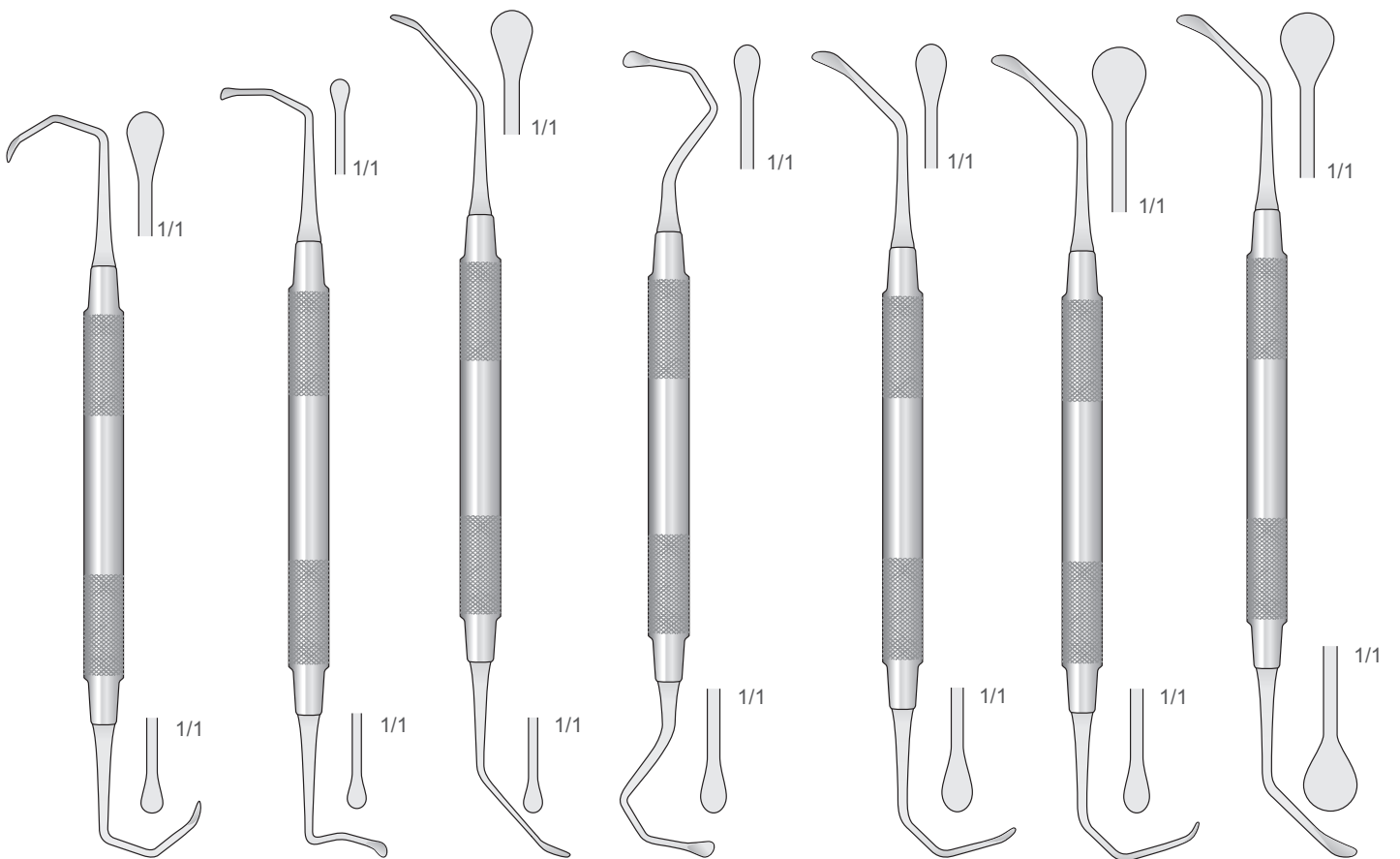

**EN-M1**  
160 mm

**EN-M2**  
160 mm

**EN-M3**  
180 mm

**EN-M4**  
170 mm

**EN-M5**  
175 mm

**EN-M6**  
175 mm

**EN-M7**  
180 mm

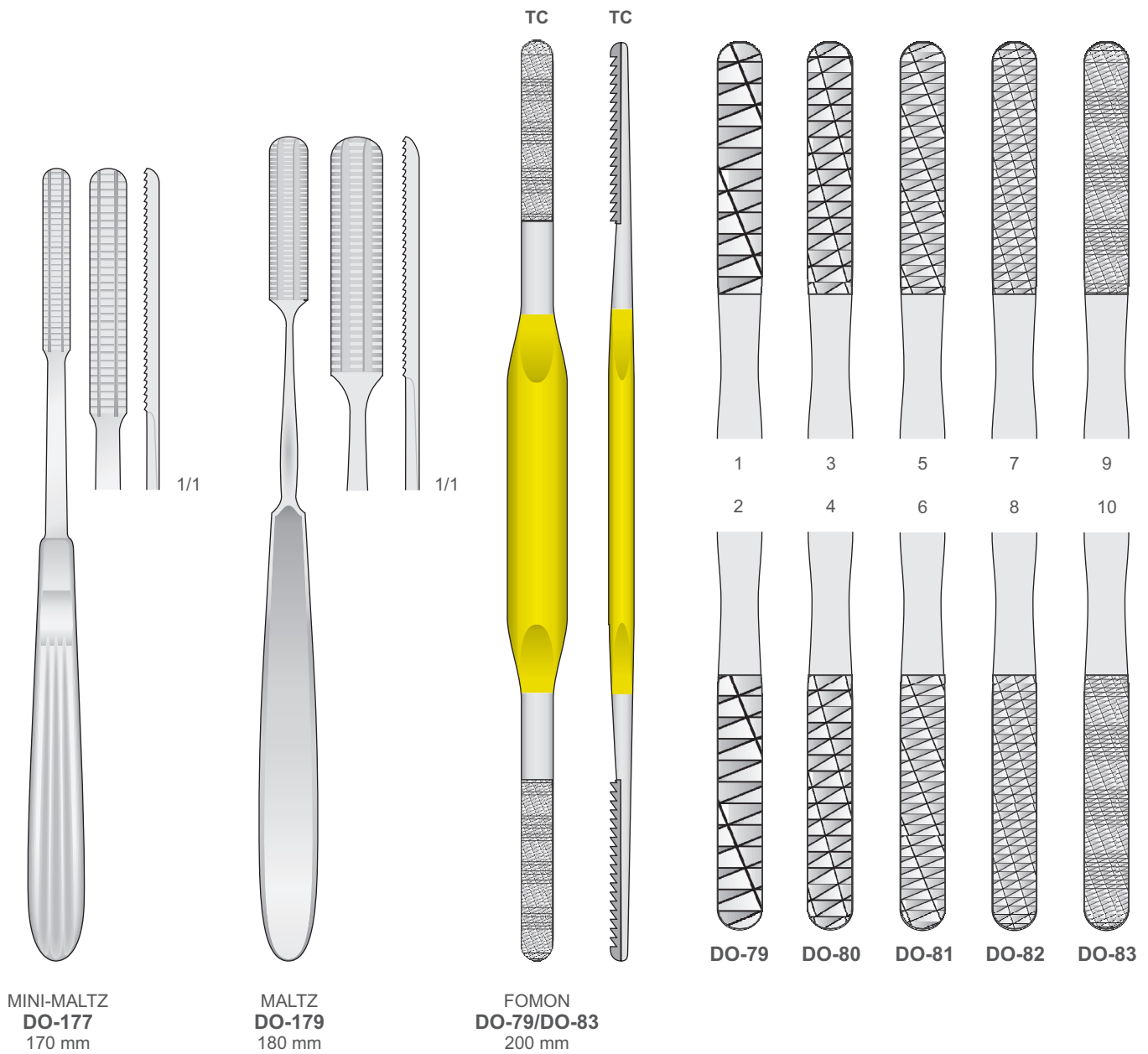

Nasenraspeln  
Nasal Rasps  
Raspe nasali  
Raspadores nasales  
Râpes nasales

Glabellaraspeln - Nasenraspeln  
Glabella Rasps - Nasal Rasps  
Raspe per glabella - Raspe nasali  
Escofinas para glabella - Raspadores nasales  
Râpes pour la glabelle - Râpes nasales

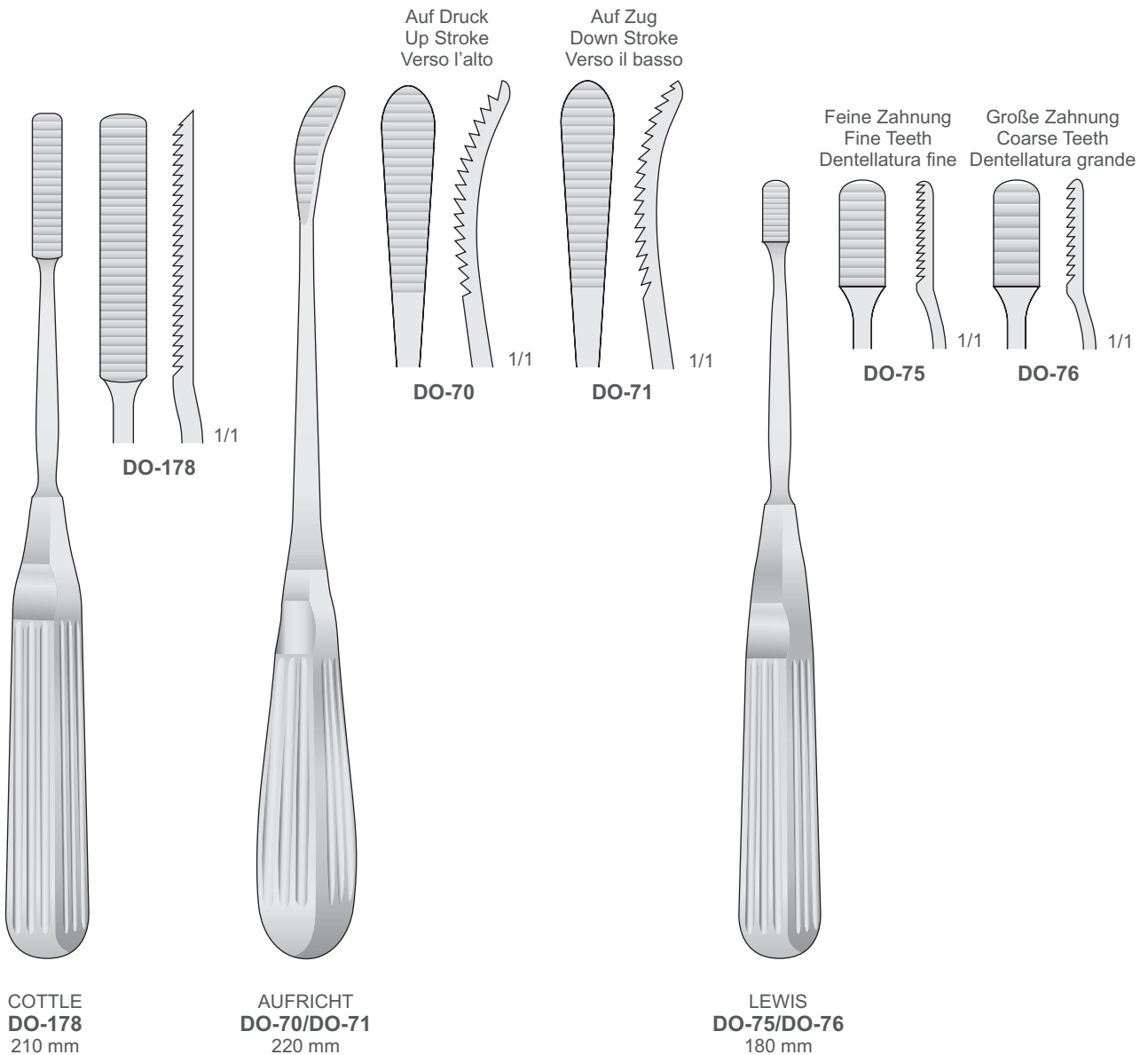

Osteotome  
Osteotomes  
Osteotomi  
Osteòtomos  
Ostéotomes

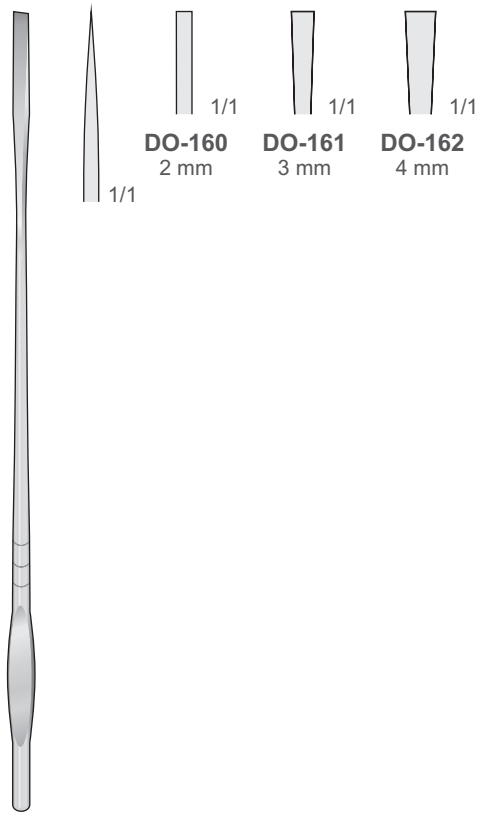

WALTER  
**DO-160/DO-162**  
190 mm

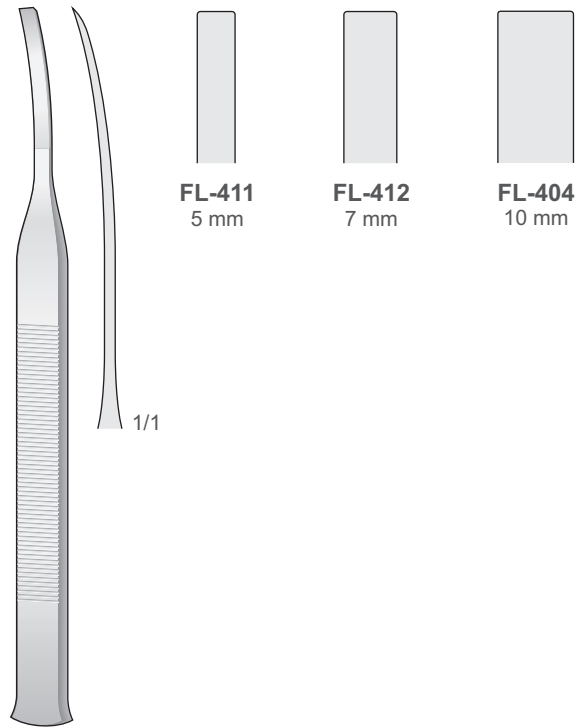

TESSIER  
**FL-404/FL-412**  
160 mm

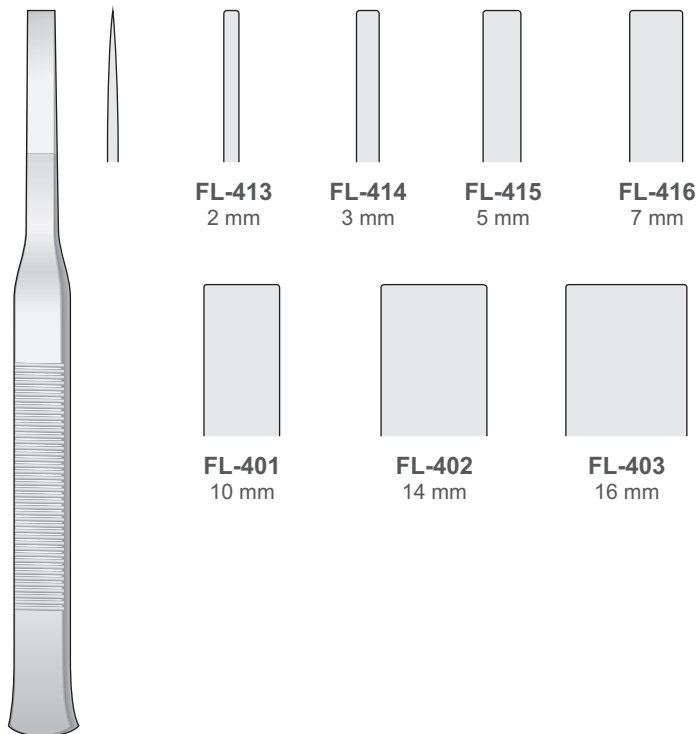

TESSIER  
**FL-401/FL-416**  
160 mm

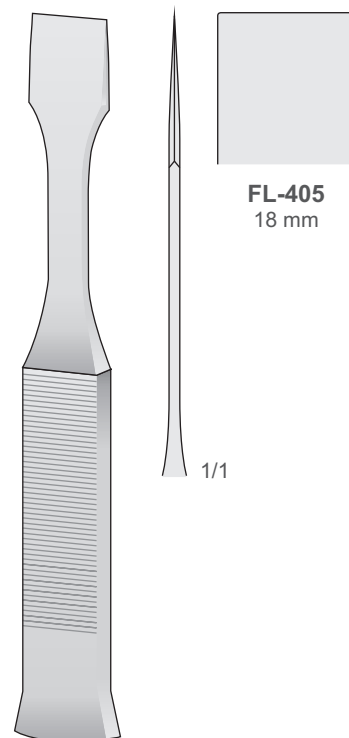

TESSIER  
**FL-405**  
160 mm

Osteotome  
Osteotomes  
Osteotomi  
Osteòtomos  
Ostéotomes

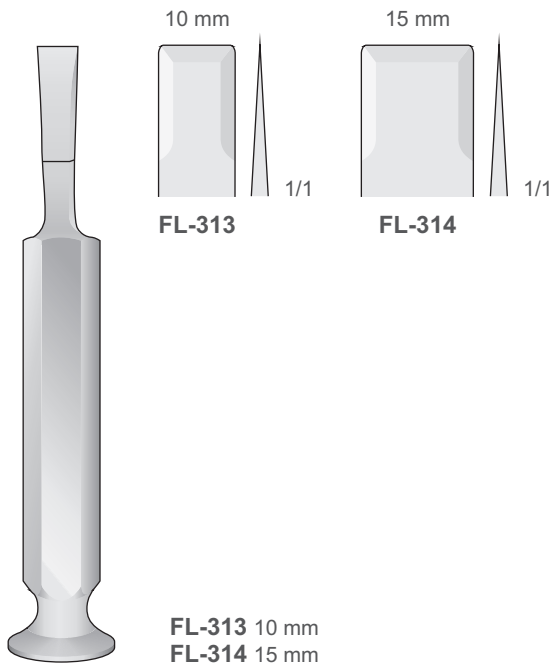

TESSIER  
FL-313/FL-314  
160 mm

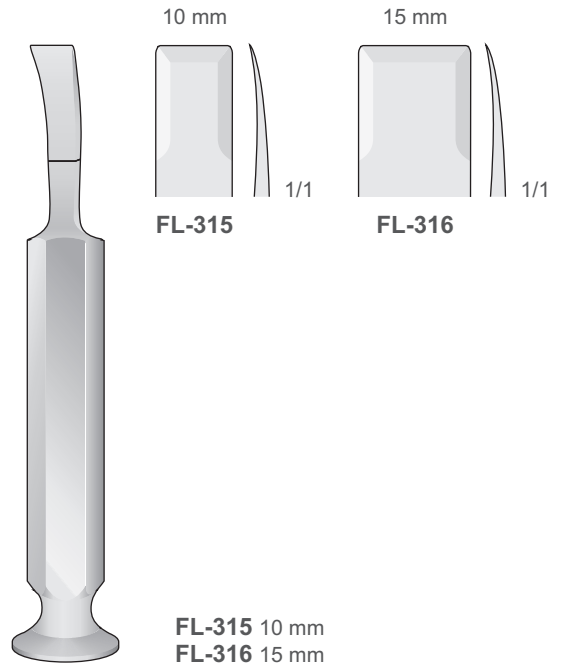

TESSIER  
FL-315/FL-316  
160 mm

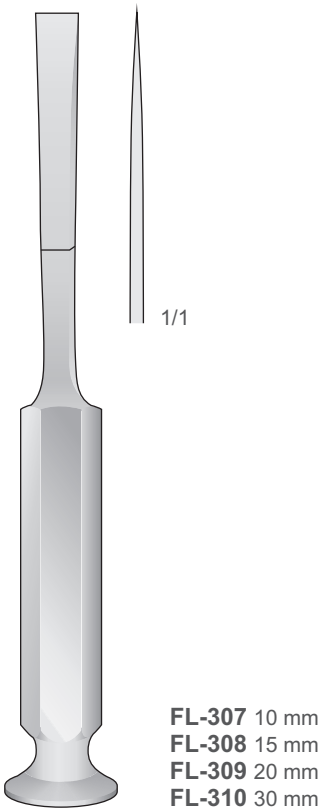

TESSIER  
FL-307/FL-310  
200 mm

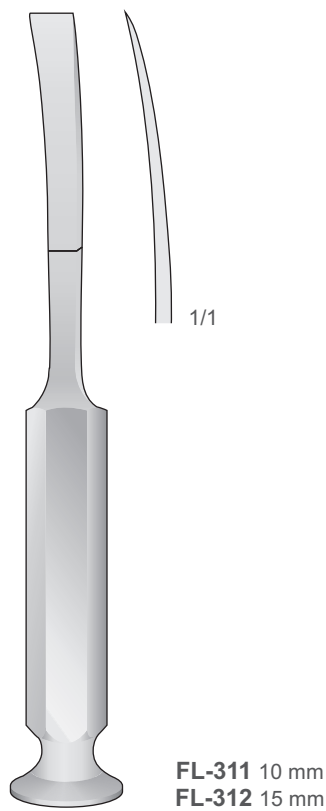

TESSIER  
FL-311/FL-312  
200 mm

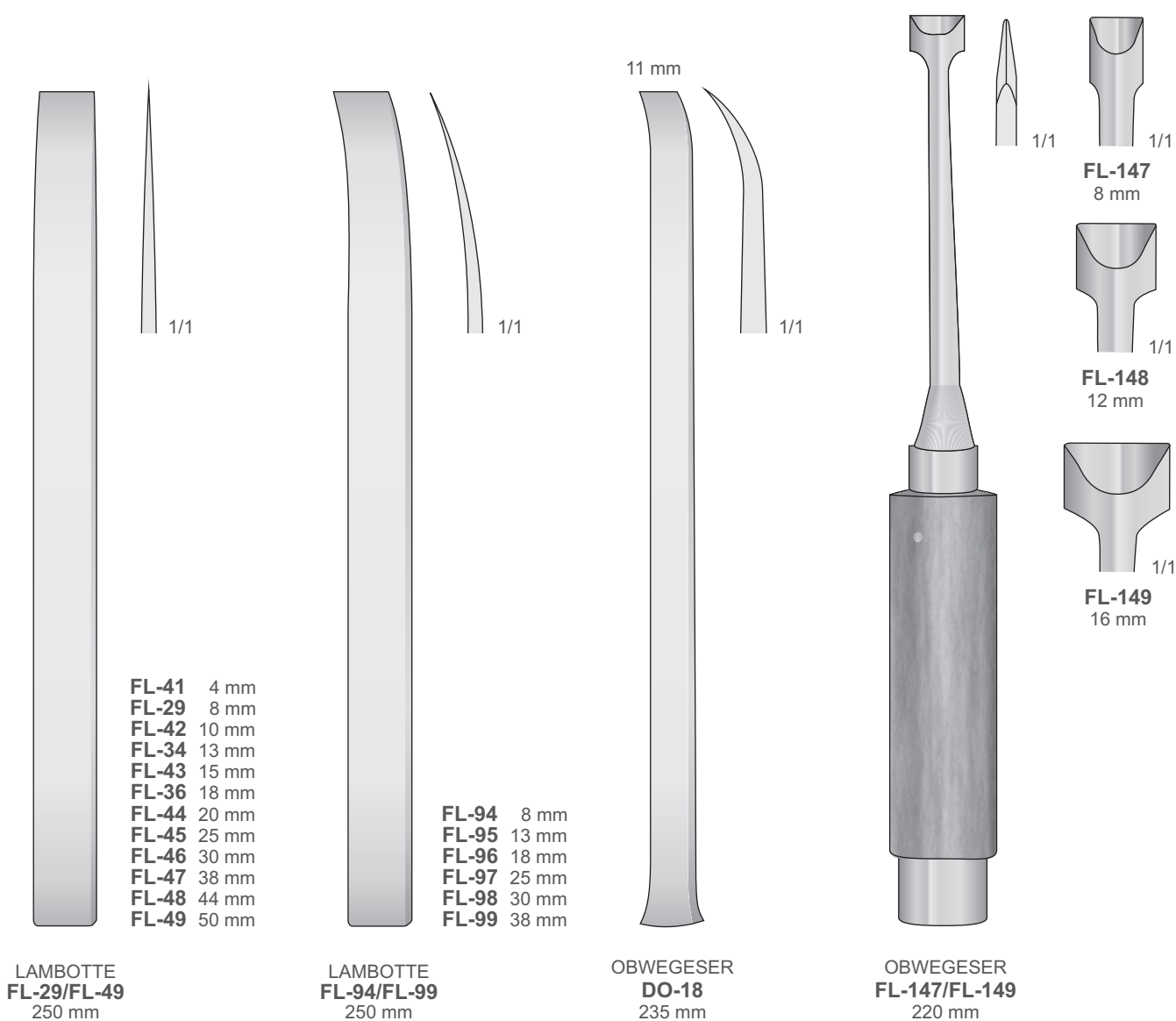



Osteotome  
Osteotomes  
Osteotomi  
Osteòtomos  
Ostéotomes

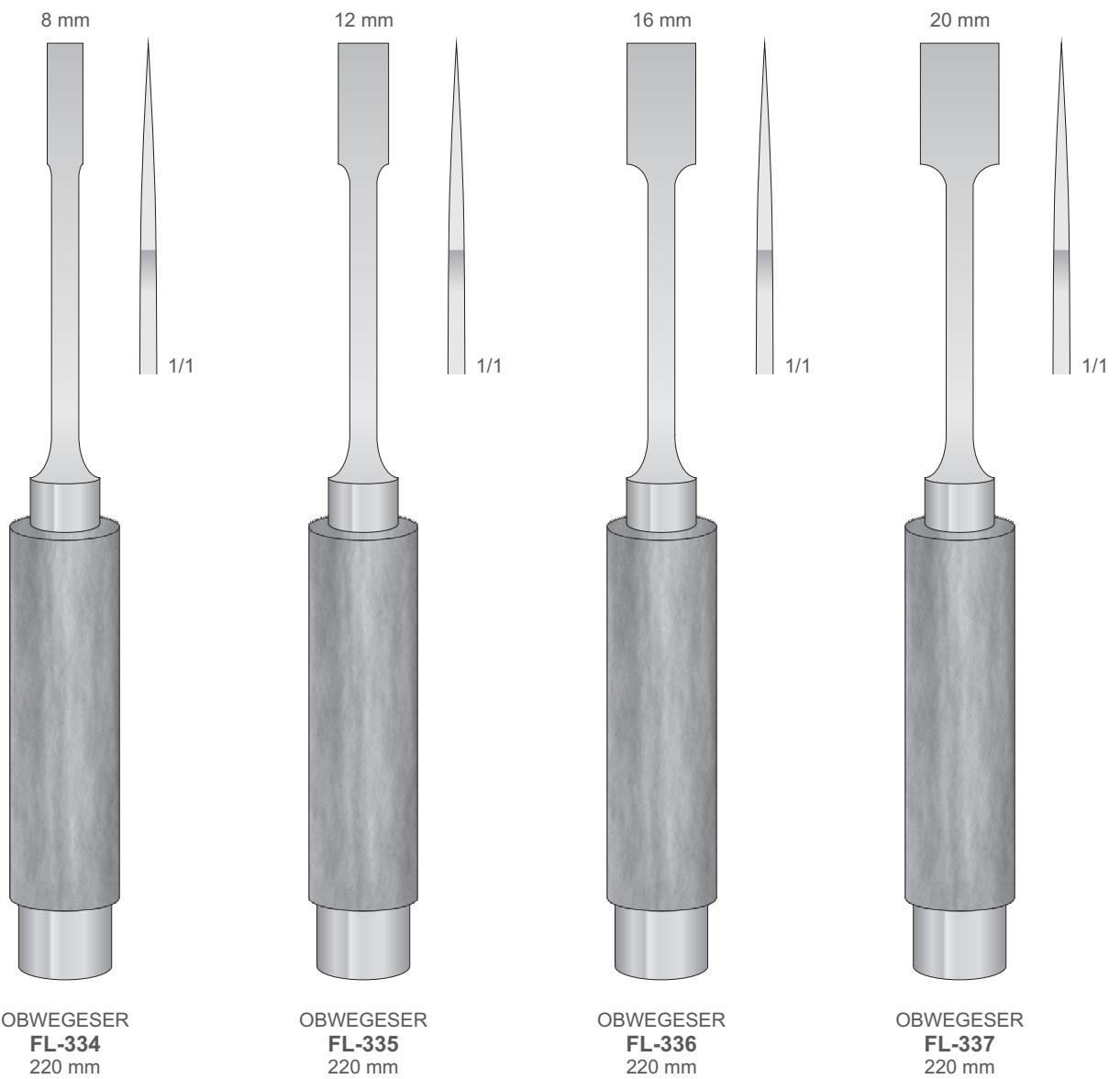

Nasenseptum Osteotome  
Nasal Septum Osteotomes  
Osteotomi per setto nasale  
Osteòtomos para el tabique nasal  
Ostéotomes pour cloison nasale

Graduiert - Graduated  
Graduato - Graduado  
Gradué

U form

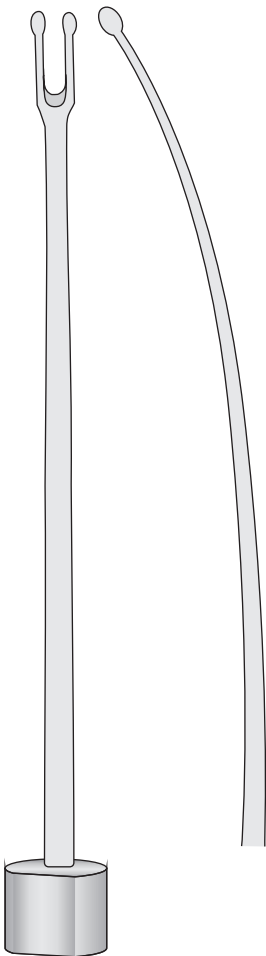

OBWEGESER  
**DO-110**  
185 mm

V form

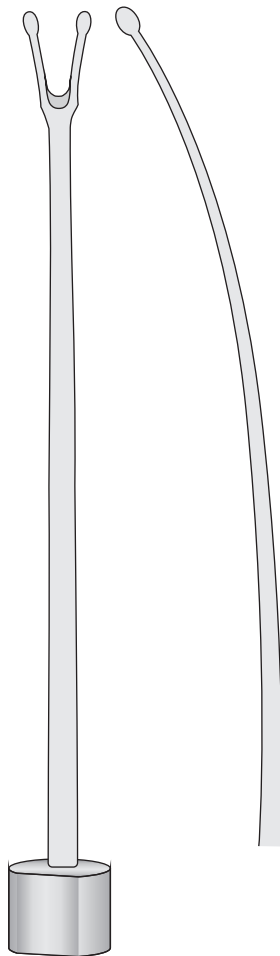

OBWEGESER  
**DO-112**  
185mm

4 mm

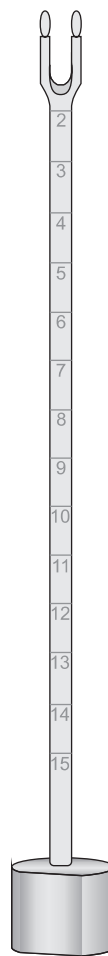

OBWEGESER  
**DO-120**  
185 mm

6 mm

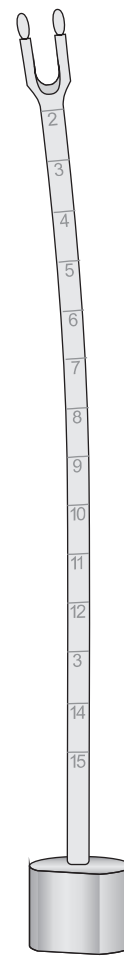

OBWEGESER  
**DO-121**  
185 mm

8 mm

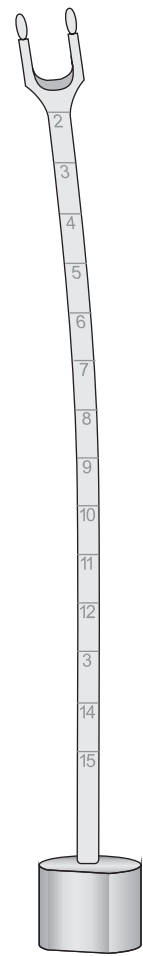

OBWEGESER  
**DO-122**  
185 mm

Osteotome  
Osteotomes  
Osteotomi  
Osteòtomos  
Ostéotomes

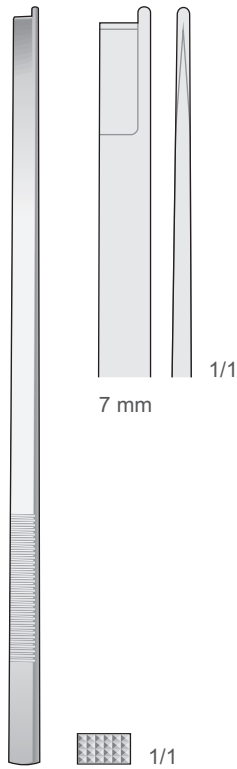

NEIVERT-ANDERSON  
**DO-276**  
205 mm

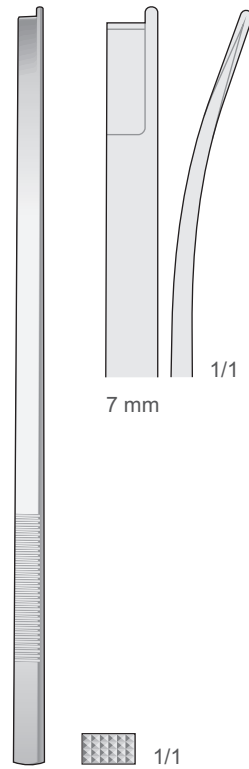

NEIVERT-ANDERSON  
**DO-277**  
205 mm

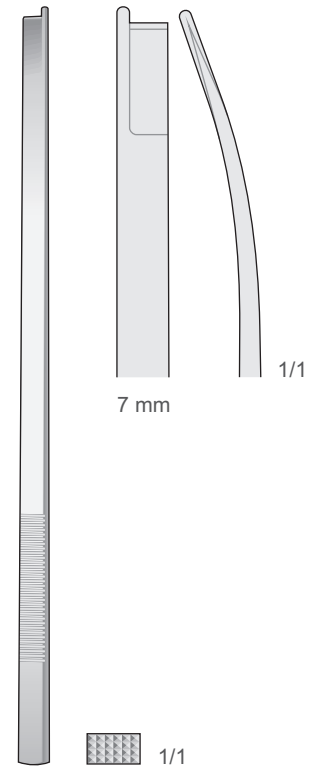

NEIVERT-ANDERSON  
**DO-278**  
205 mm

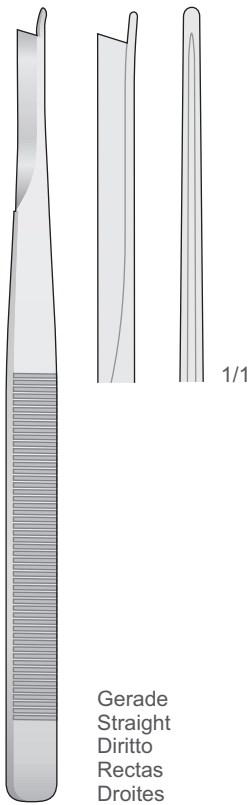

SILVER  
**DO-34**  
180 mm

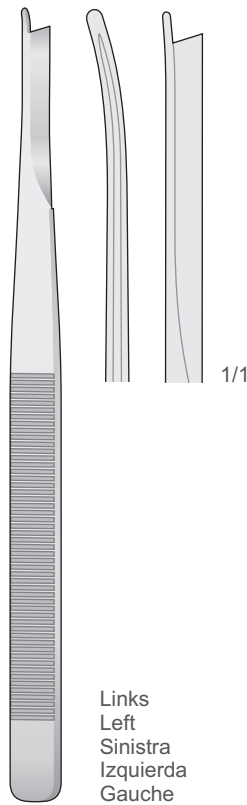

SILVER  
**DO-35**  
180 mm

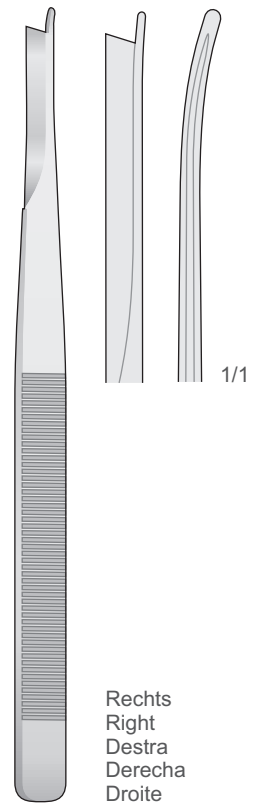

SILVER  
**DO-36**  
180 mm

Osteotome  
Osteotomes  
Osteotomi  
Osteótomos  
Ostéotomes

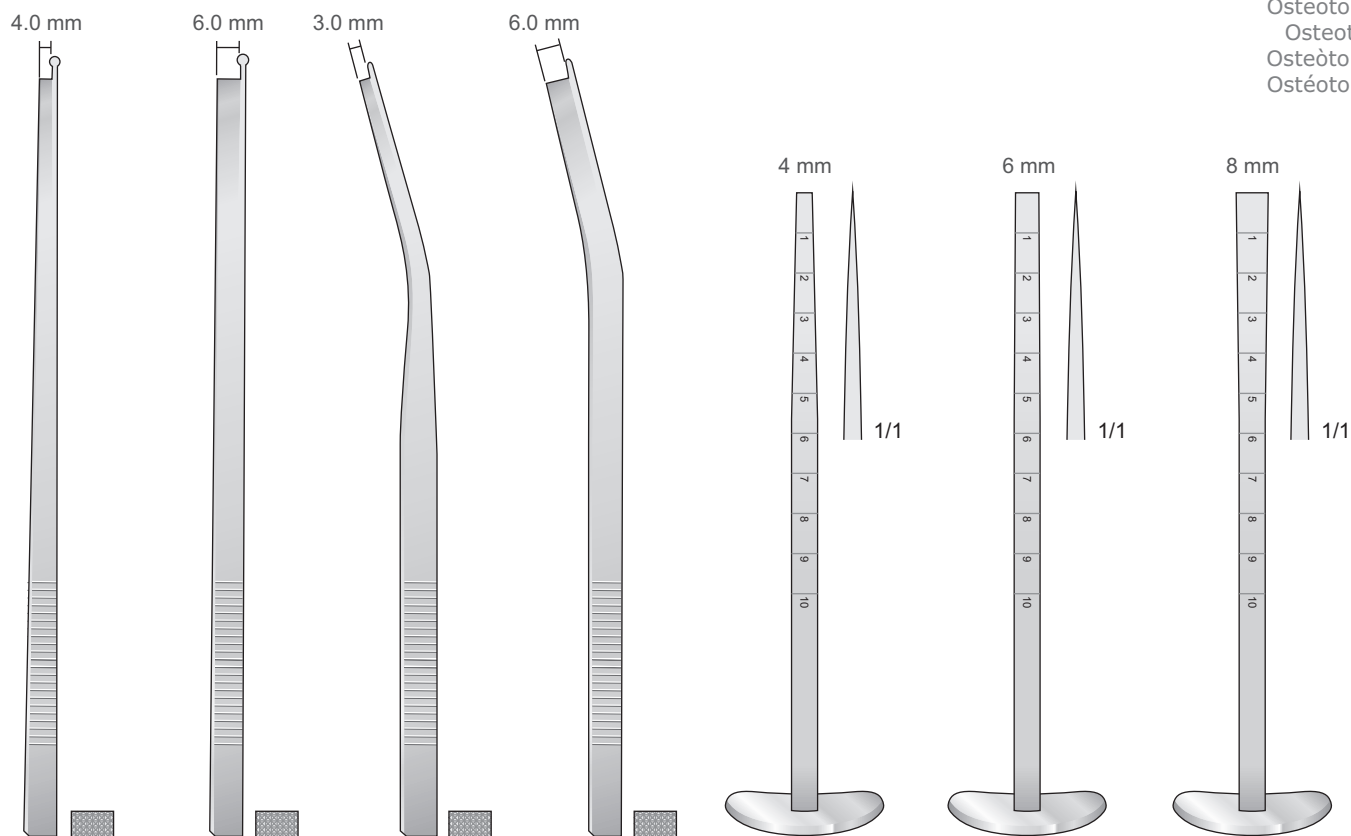

**DO-118**  
200 mm

**DO-119**  
200 mm

**DO-84**  
200 mm

**DO-85**  
200 mm

**DO-260**  
160 mm

**DO-261**  
160 mm

**DO-262**  
160 mm

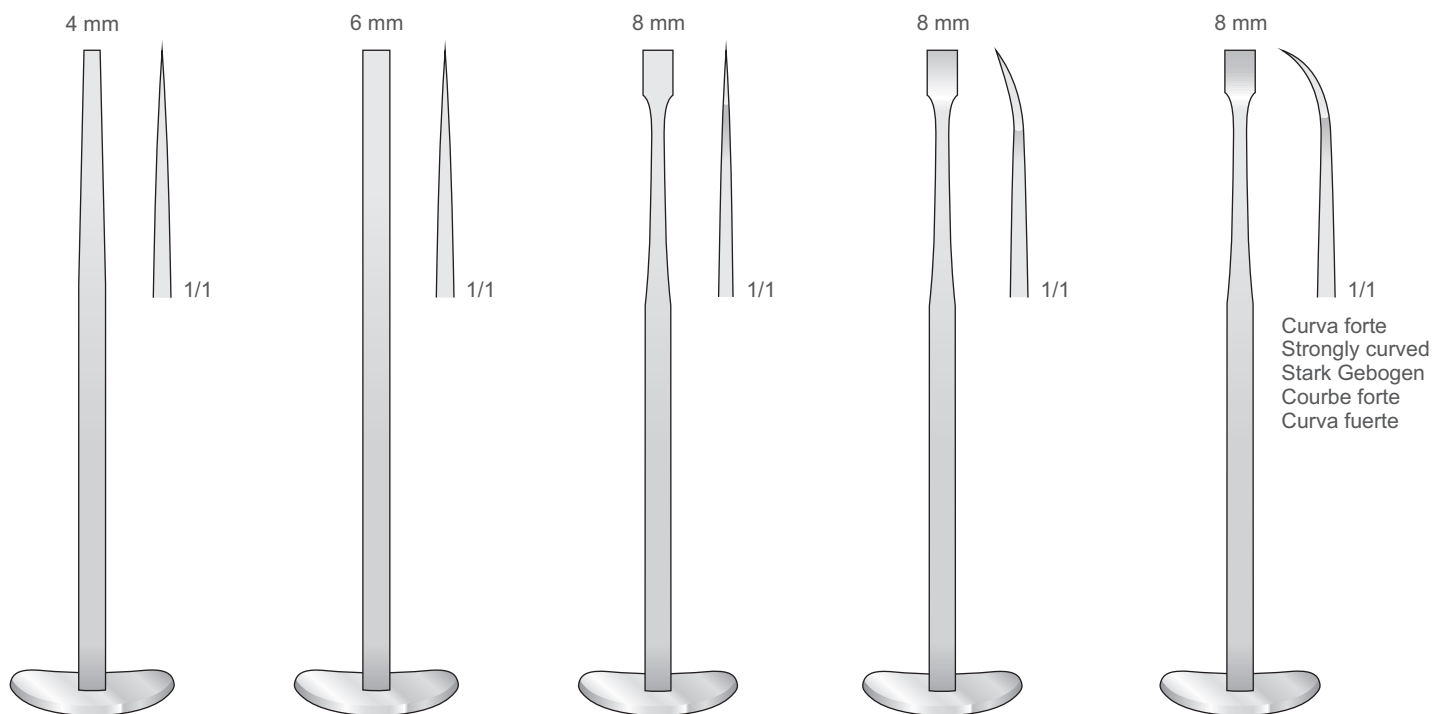

Curva forte  
Strongly curved  
Stark Gebogen  
Courbe forte  
Curva fuerte

**DO-257**  
165 mm

**DO-258**  
165 mm

**DO-203**  
165 mm

**DO-205**  
165 mm

**DAUTREY-MUNRO**  
**DO-206**  
165 mm

Hämmer - Osteotome  
Mallets - Osteotomes  
Martelli - Osteotomi  
Martillos - Osteòtomos  
Maillets - Ostéotomes

Ø 20 mm - 140 g



**FL-01**  
165 mm

Ø 25 mm - 300 g

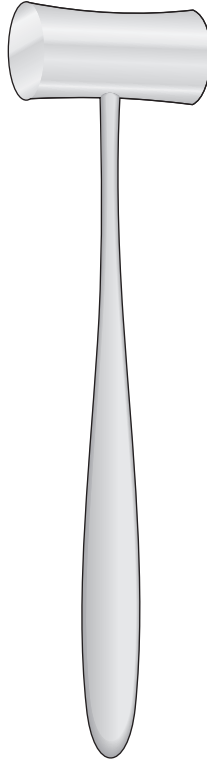

LUCAE  
**FL-10M**  
190 mm

Ø 30 mm - 240 g

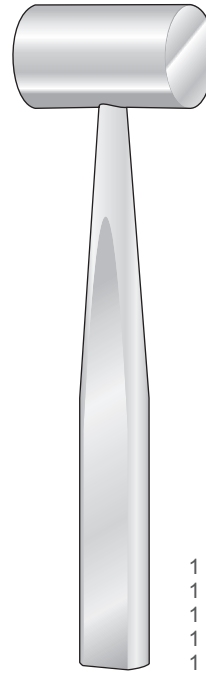

COTTLE  
**FL-104**  
185 mm

1 Seite flach - 1 Seite convex  
1 Side flat - 1 Side convex  
1 Lato piatto - 1 Lato convesso  
1 Parte plana - 1 Parte convessa  
1 Face plate - 1 Face convexe

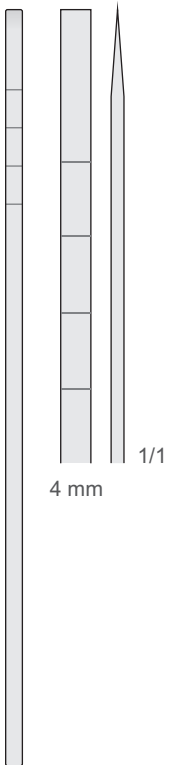

COTTLE  
**DO-140**  
180 mm

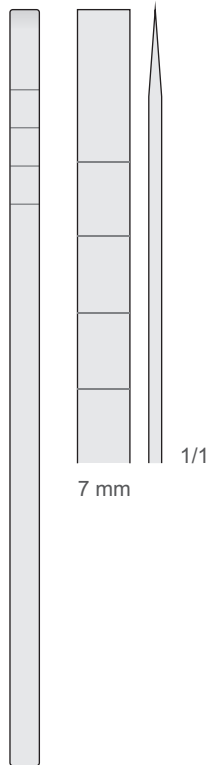

COTTLE  
**DO-141**  
180 mm

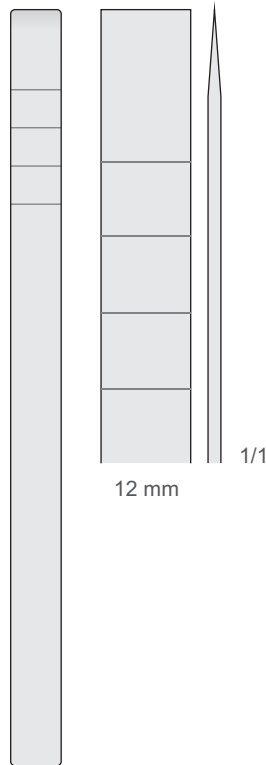

COTTLE  
**DO-143**  
180 mm

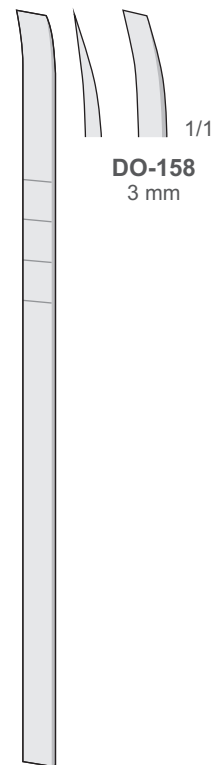

COTTLE  
**DO-158**  
180 mm

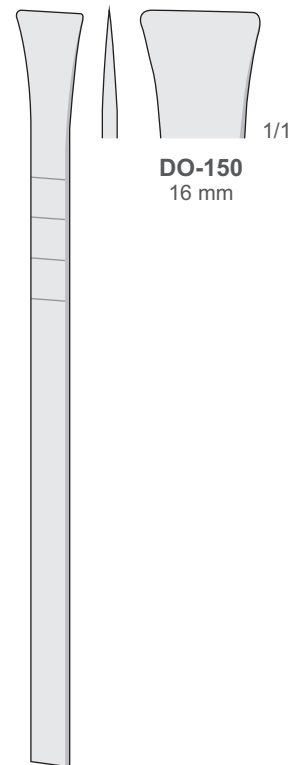

COTTLE  
**DO-150**  
180 mm

Repositionszangen  
Reposition forceps  
Pinze per riposizione  
Pinzas para reposicionar  
Pincas à réposition

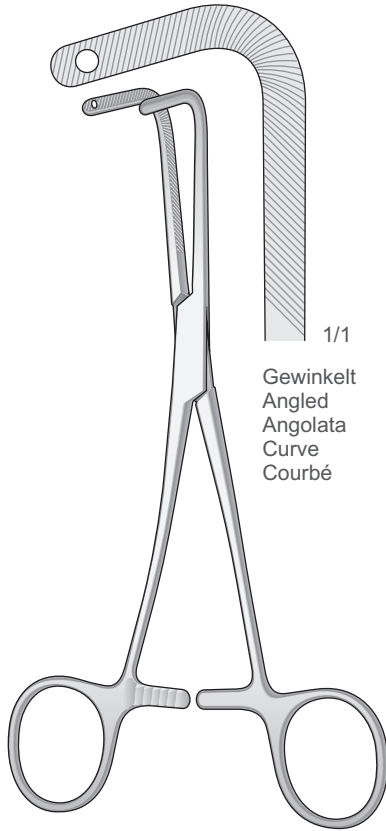

1/1  
Gewinkelt  
Angled  
Angolata  
Curve  
Courbé

**P-341**  
200 mm

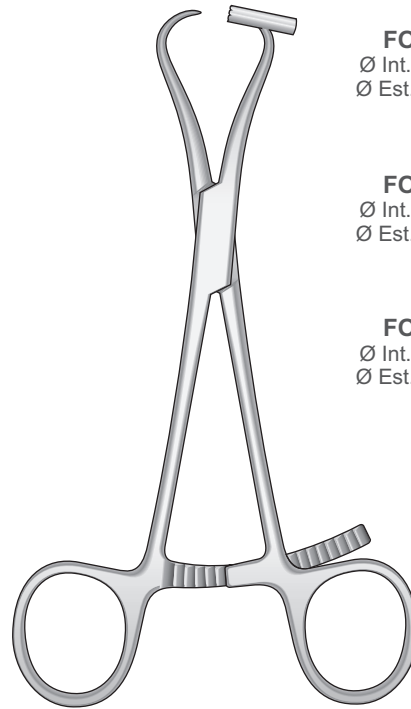

○  
**FO-240**  
Ø Int. 1,0 mm  
Ø Est. 2,0 mm

○  
**FO-241**  
Ø Int. 1,3 mm  
Ø Est. 2,3 mm

○  
**FO-242**  
Ø Int. 1,6 mm  
Ø Est. 2,6 mm

**FO-240/FO-242**  
140 mm

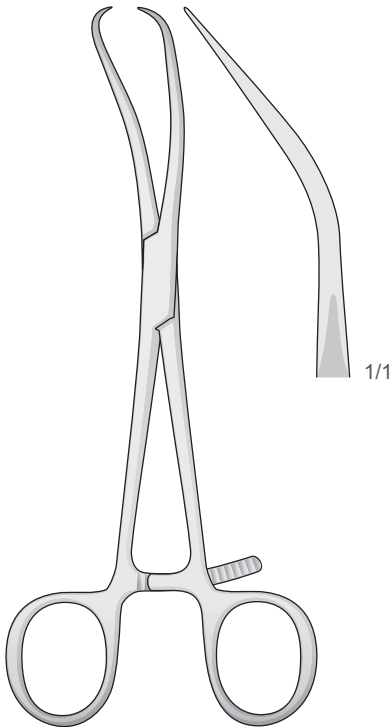

**REILL**  
**FO-64**  
170 mm

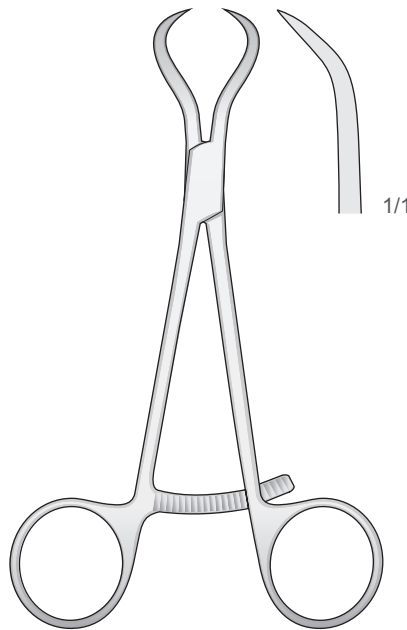

**FO-66**  
135 mm

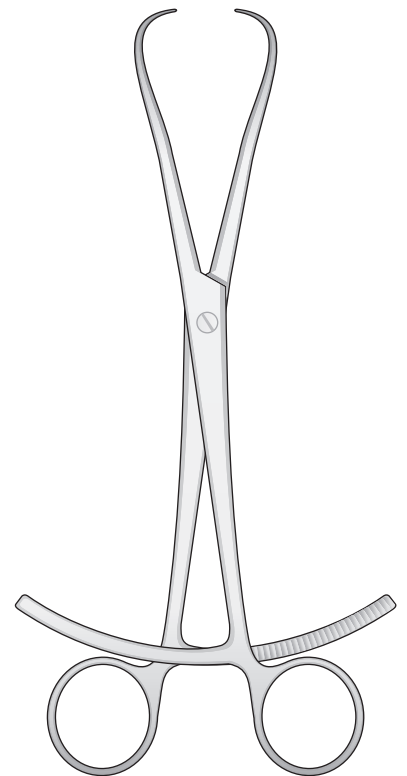

**FO-68**  
200 mm

Repositionszangen  
Reposition forceps  
Pinze per riposizione  
Pinzas para reposicioner  
Pincés à réposition

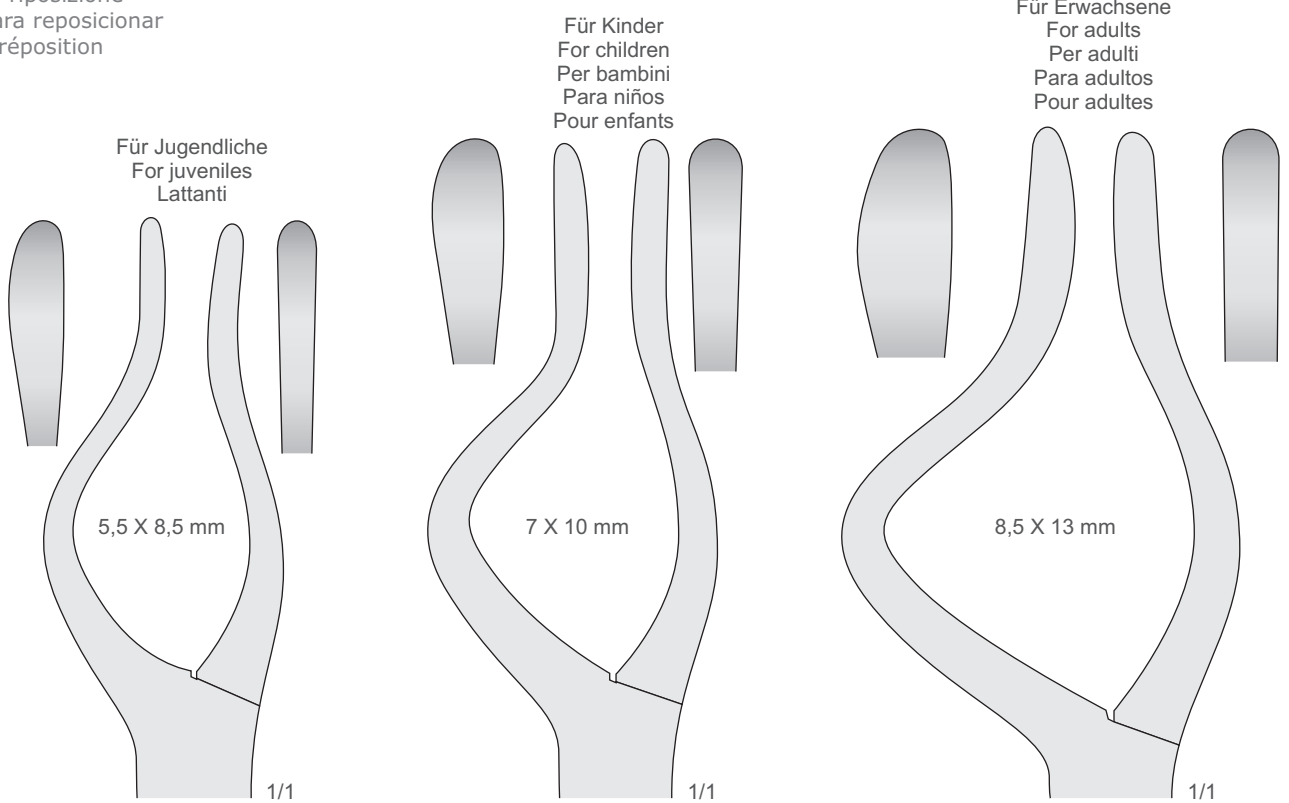

**DO-10**  
**DO-11**  
225 mm

**DO-12**  
**DO-13**  
235 mm

**DO-14**  
**DO-15**  
240 mm

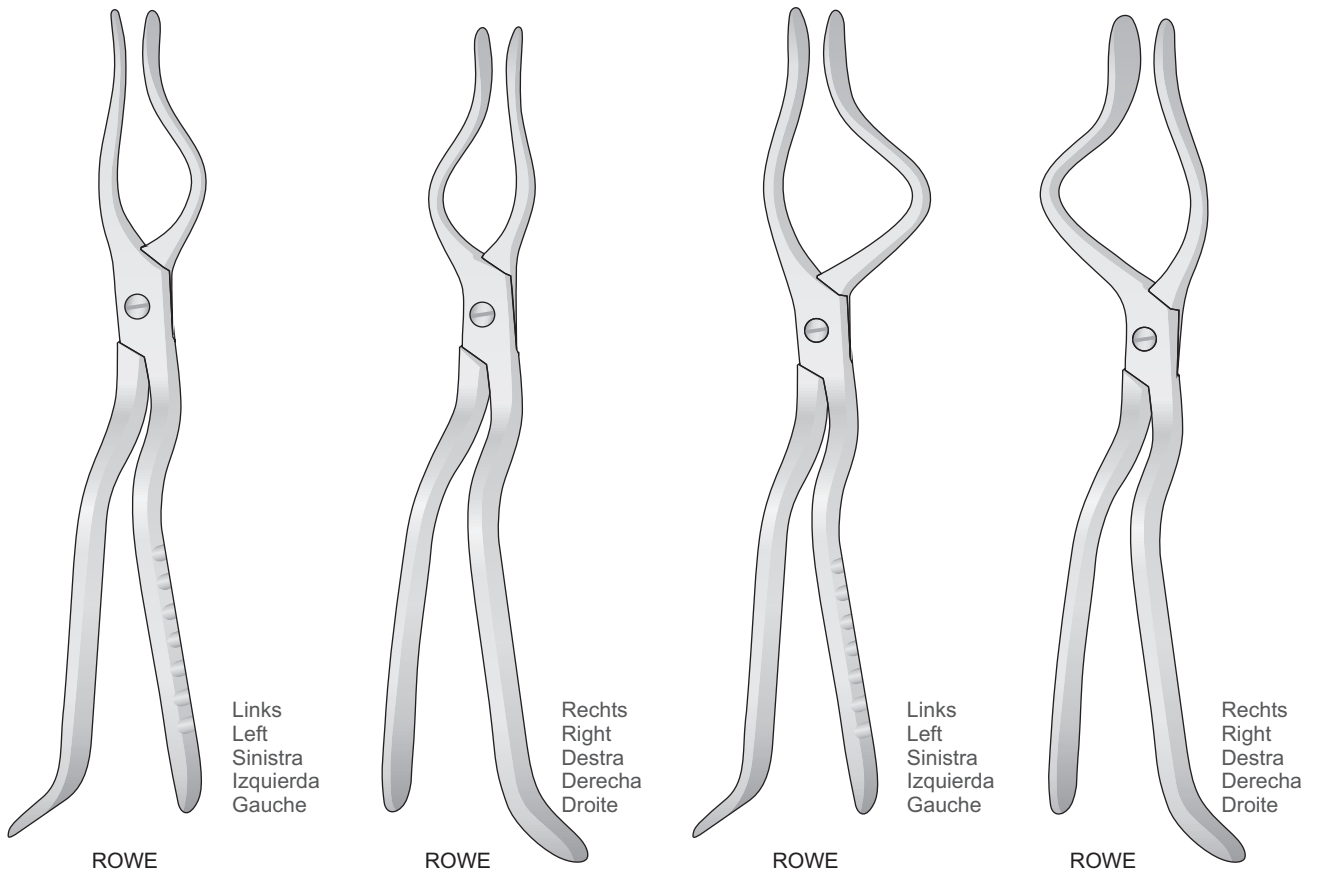

Knochensplitterzangen  
Bone cutting forceps  
Pinze per ossa  
Cizallas para huesos  
Pincas coupantes à os

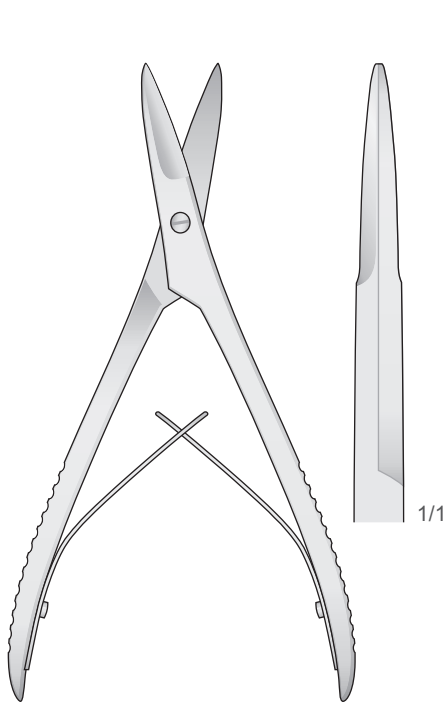

**FO-63**  
160 mm

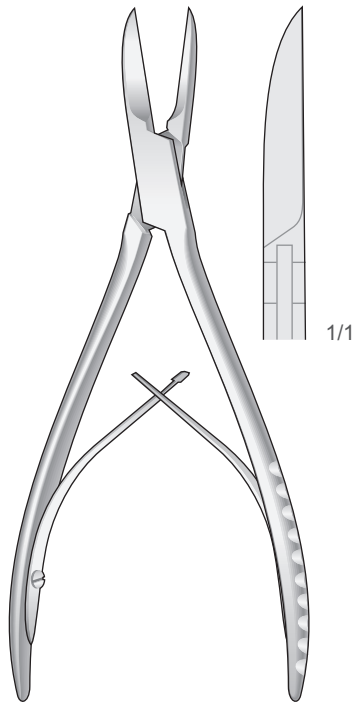

**COTTLE-KAZANJIAN**  
**FO-95**  
190 mm

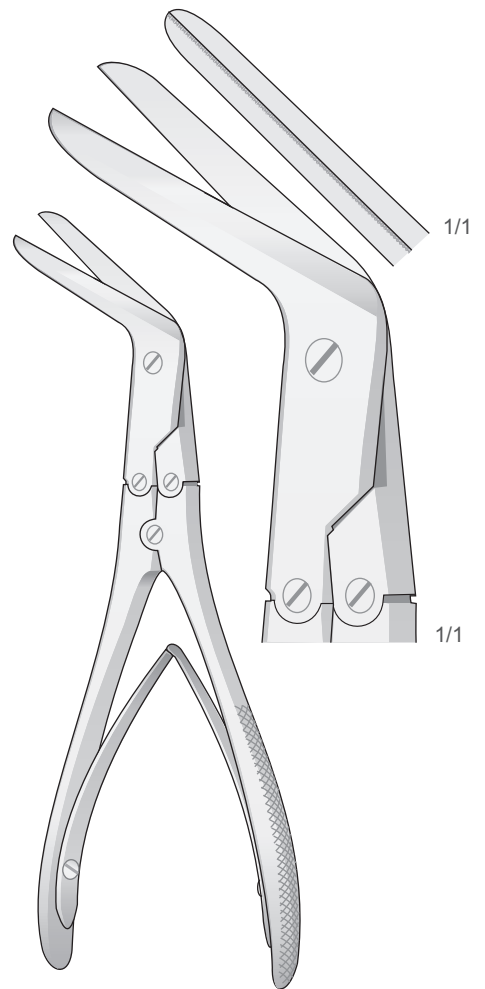

**KILLIAN**  
**FO-143**  
210 mm

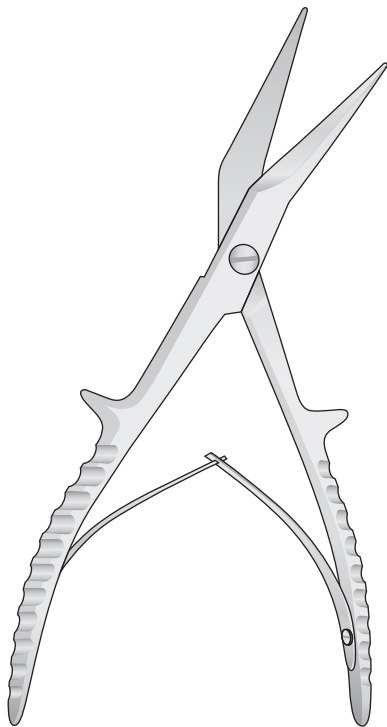

**FG-110**  
195 mm

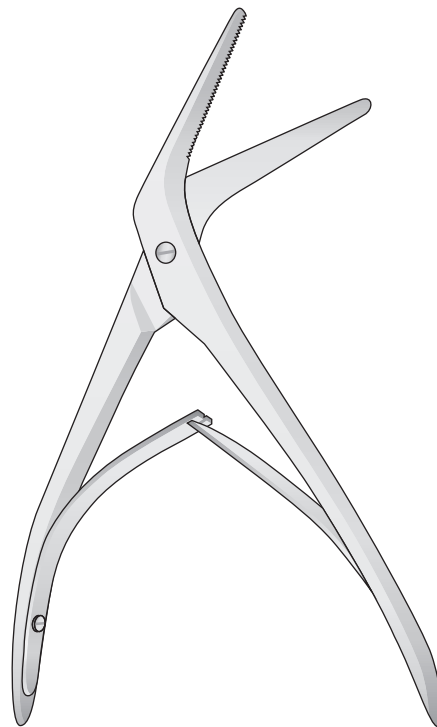

**JACKSON-TESSIER**  
**FG-111**  
190 mm



Knochenchirurgie  
Bone Surgery  
Chirurgia ossea  
Pinzas para huesos  
Chirurgie osseuse

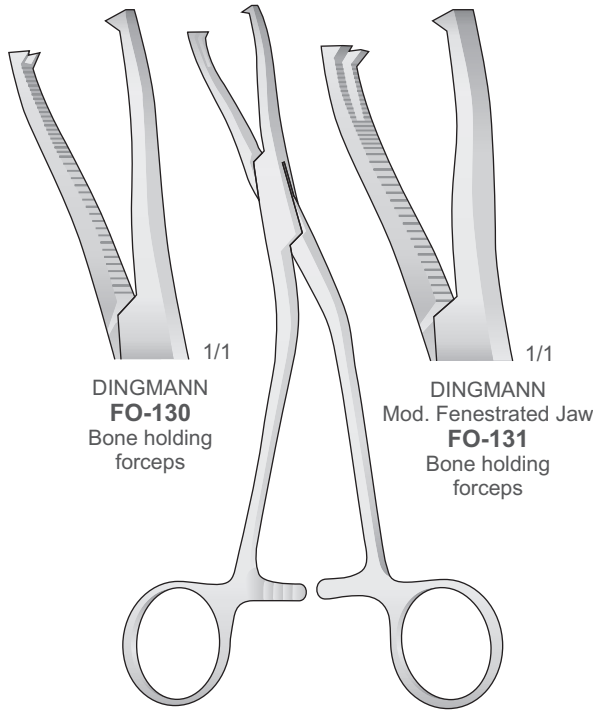

DINGMANN  
**FO-130**  
Bone holding  
forceps

DINGMANN  
Mod. Fenestrated Jaw  
**FO-131**  
Bone holding  
forceps

DINGMANN  
**FO-130/FO-131**  
190 mm

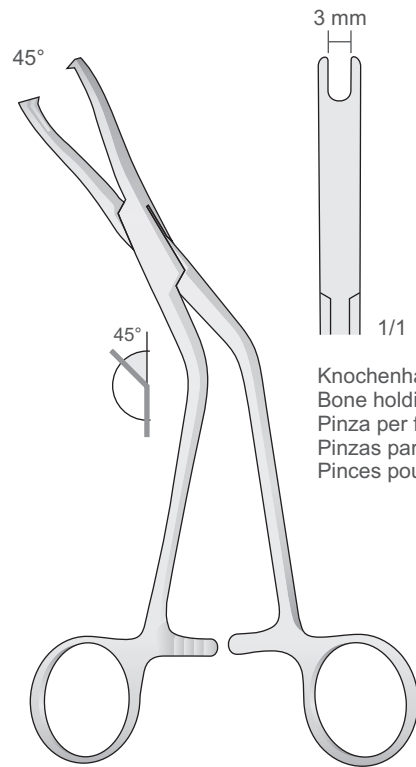

Knochenhaltezange  
Bone holding forceps  
Pinza per fissare l'osso  
Pinzas para coger huesos  
Pinces pour tenir l'os

DINGMANN - Mod. Fenestrated Jaw  
**FO-131S**  
190 mm

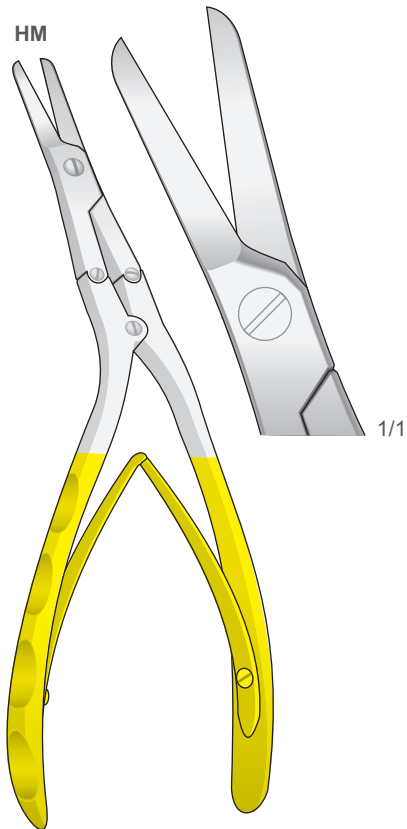

HM  
**CAPLAN**  
**FO-144**  
200 mm

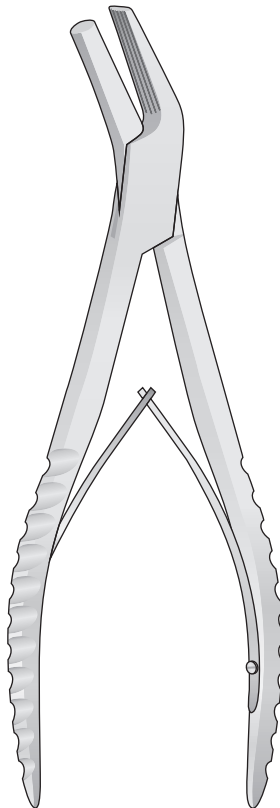

**TESSIER**  
**FO-137**  
220 mm

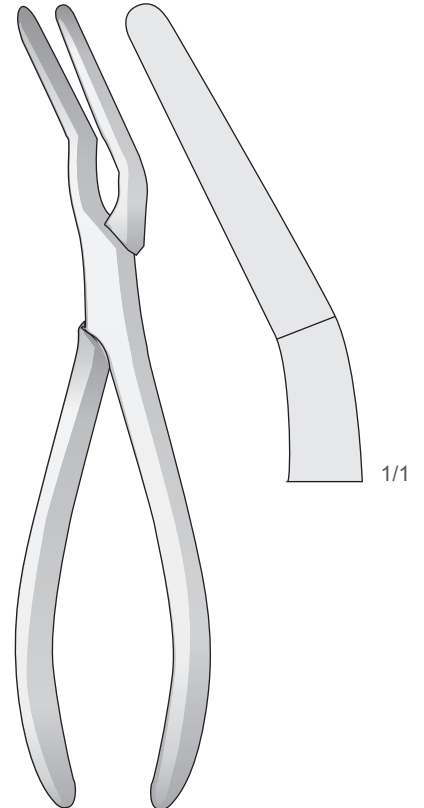

**ASCH**  
**DO-157**  
230 mm

Für Jochbögen  
For zygomatic archs  
Per arco zigomatico  
Para arcos cigomáticos  
Pour arcades cygomatique

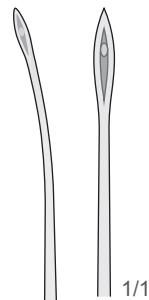

1/1

Für Oberkiefer  
For maxillas  
Per mascelle  
Para maxilares superior  
Pour maxillaires supérieures



1/1

Haken-Jochbogenahle  
Zigoma hook  
Uncini per arco zigomato  
Para arcos cigomáticos  
Pour arcades cygomatique

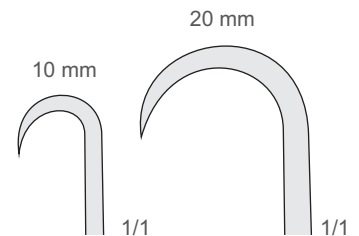

10 mm

20 mm

1/1

1/1

**DO-323**  
10 mm

**DO-324**  
20 mm

Für Unterkiefer  
For mandibles  
Per mandibola  
Para mandibula  
Pour maxillaires inférieures

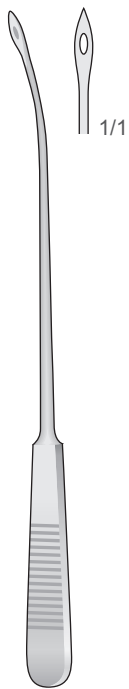

1/1

**OBWEGESER**  
**DO-30**  
140 mm

**OBWEGESER**  
**DO-31**  
230 mm

**OBWEGESER**  
**DO-32**  
180 mm

**DINGMAN**  
**DO-323** 10 mm  
**DO-324** 20 mm  
190 mm

Drahtinstrumente  
Wire Instruments  
Strumenti per fili d'acciaio  
Instrumentos para alambre  
Instruments pour fils métalliques

Tamponstopfer  
Gauze Packer  
Porta tamponi  
Tamponador  
Porte-tampons



LUNIATSCHEK  
**PF-6**  
170 mm

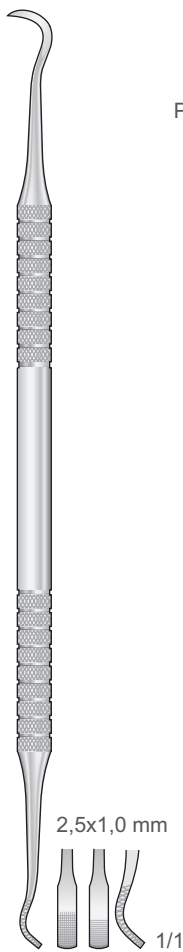

SHURE  
**DP-124**  
175 mm

Drahtpositionierer  
Wire pusher  
Posizionatore per filo  
Instrumento para  
posicionar alambre  
Positionneur à fil

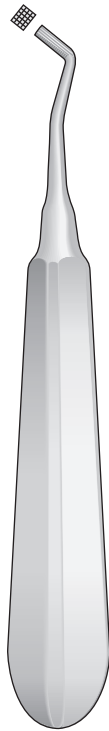

MERSHON  
**DP-50**  
140 mm

Drahtdrehklemmen  
Wire twister  
Pinza per piegare fili  
Pinza para torcer alambre  
Pince à torsader le fil

Mit Hartmetalleinsätzen  
With Hard Metal Inserts  
Con punte in metallo duro  
Con puntas de metal duro  
Avec mors en métal dur

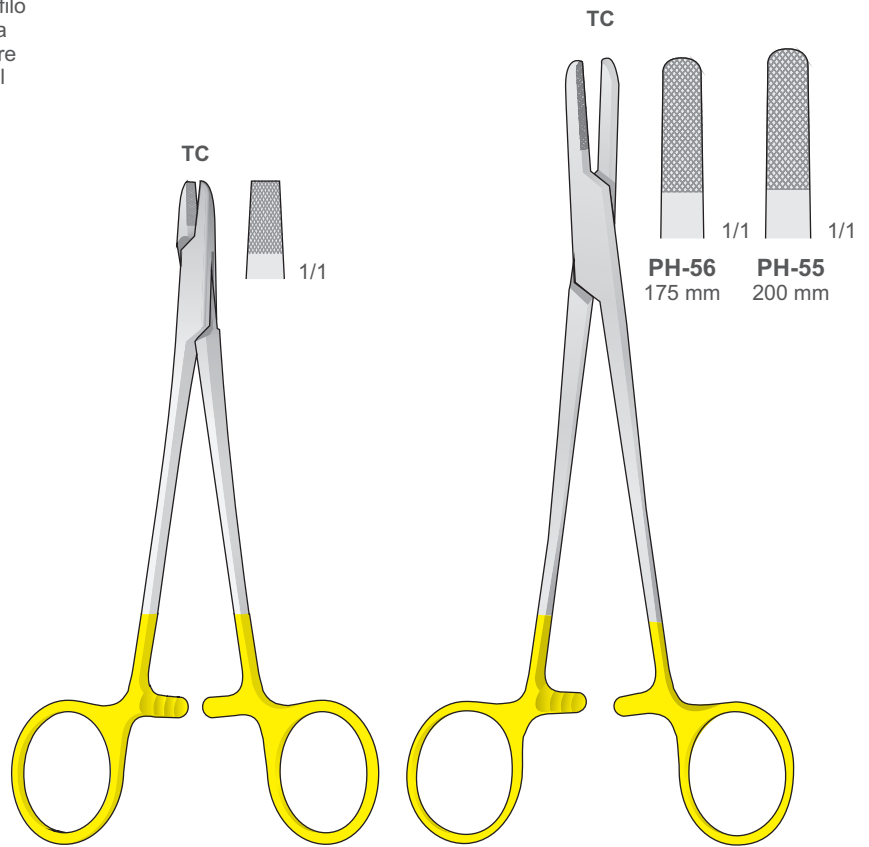

**PH-58**  
150 mm

**PH-55/PH-56**

**PH-56** 175 mm  
**PH-55** 200 mm

Drahtschneidezangen  
Wire cutting pliers  
Tronchesi per fili metallici  
Alicates para cortar alambre  
Pincers à couper le fil

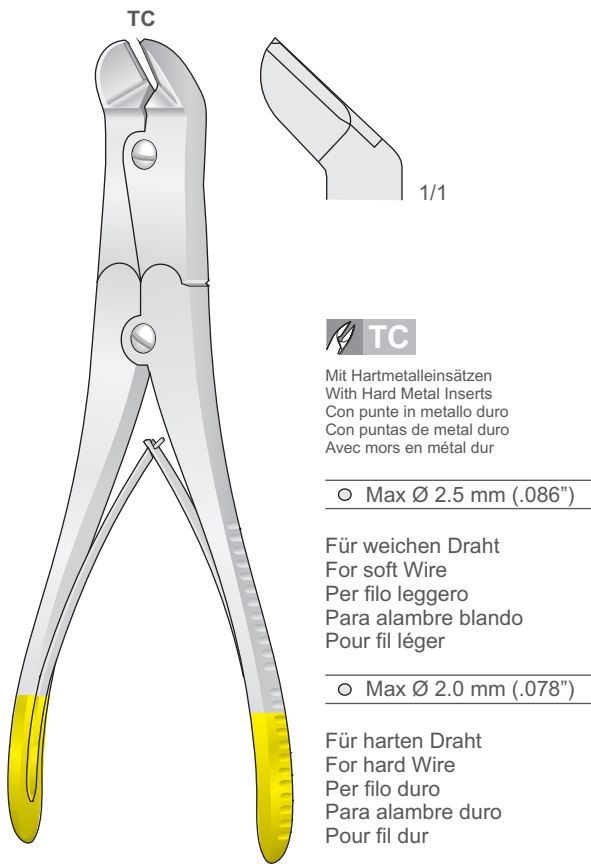

**LX-105**  
230 mm

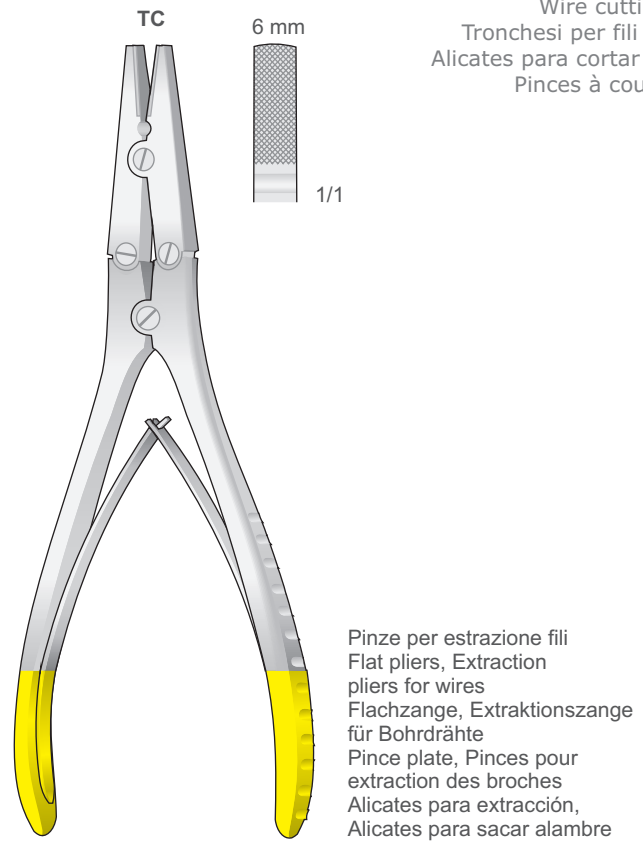

**LX-141**  
180 mm

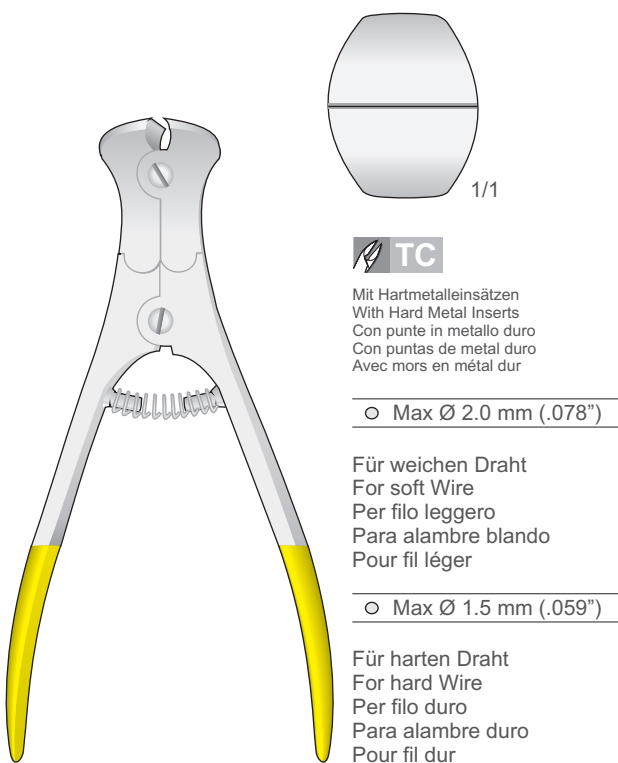

**LX-102**  
145 mm

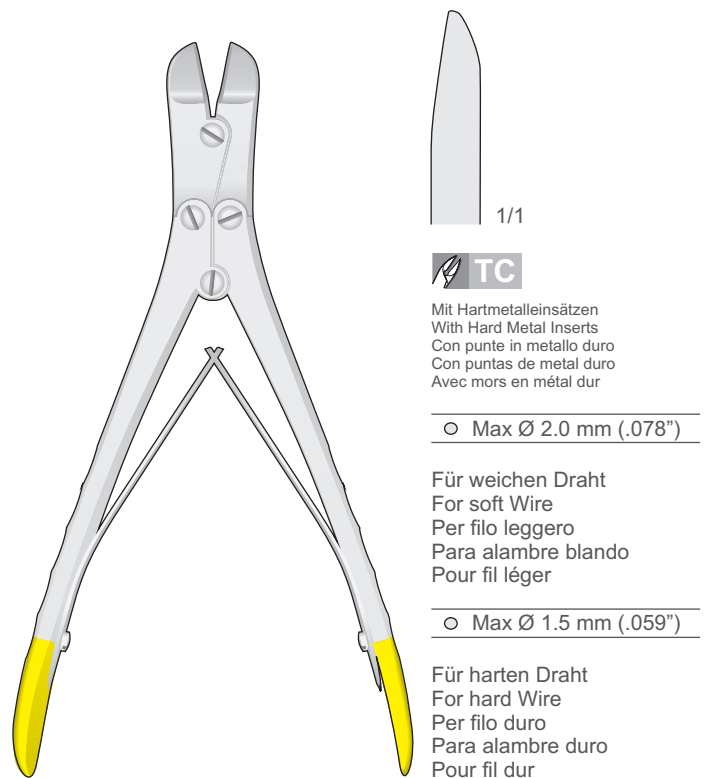

**LX-103**  
170 mm

Drahtschneidezangen  
Wire cutting pliers  
Tronchesi per fili metallici  
Alicates para cortar alambre  
Pincès à couper le fil

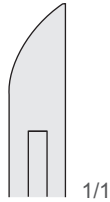
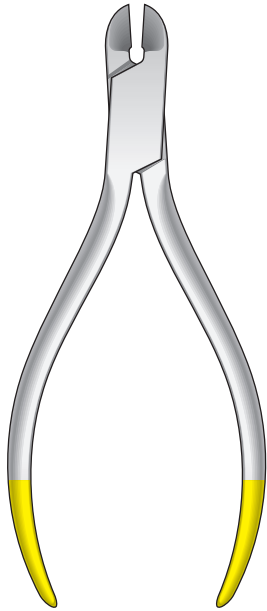

Mit Hartmetalleinsätzen  
With Hard Metal Inserts  
Con punte in metallo duro  
Con puntas de metal duro  
Avec mors en métal dur

- Max Ø 0.5 mm (.020")
- 0.41 x 0.56 mm (.016" x .022")

Für weichen und harten Draht  
For soft and hard Wire  
Per fili duri, sottili e medi  
Para alambre blando y duro  
Pour fil léger e dur

**LX-99**  
120 mm

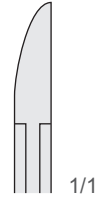
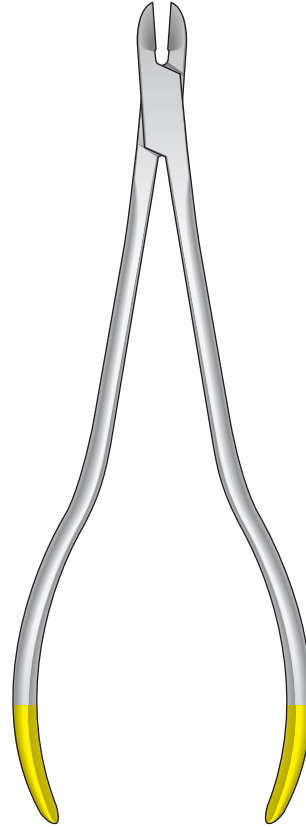

Mit Hartmetalleinsätzen  
With Hard Metal Inserts  
Con punte in metallo duro  
Con puntas de metal duro  
Avec mors en métal dur

- Max Ø 0.3 mm (.012")

Long Handle  
Con manici lunghi

Ligaturen Schneidezangen -Mini  
Mini Ligature Cutter  
Solo per rimuovere le legature  
Alicate de corte mini  
Pince coupante mini

Für weichen Draht  
For soft Wire  
Per fili sottili e morbidi  
Para alambre blando  
Pour fil léger

**LX-98**  
175 mm

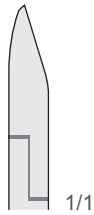
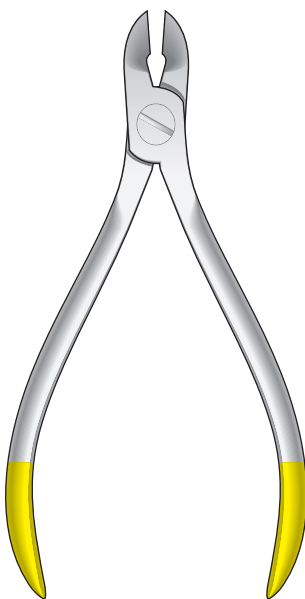

Mit Hartmetalleinsätzen  
With Hard Metal Inserts  
Con punte in metallo duro  
Con puntas de metal duro  
Avec mors en métal dur

- Max Ø 0.4 mm (.016")

Ligaturen-Cutter  
Ligature Cutter

Für weichen und harten Draht  
For soft and hard Wire  
Per filo leggero e duro  
Para alambre blando y duro  
Pour fil léger e dur

**LX-88**  
115 mm

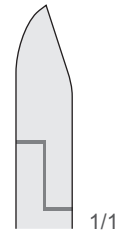
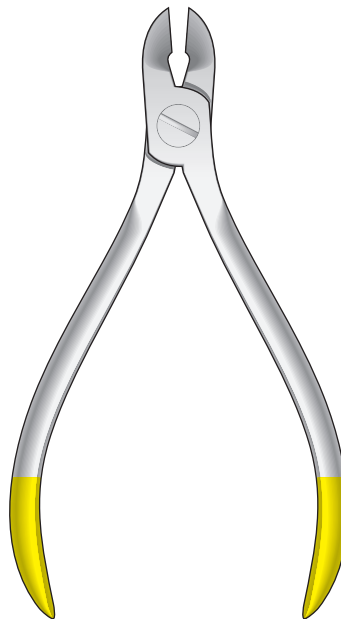

Mit Hartmetalleinsätzen  
With Hard Metal Inserts  
Con punte in metallo duro  
Con puntas de metal duro  
Avec mors en métal dur

- Max Ø 0.7 mm (.028")
- 0.56 x 0.71 mm (.022" x .028")
- ⊗ 0.53 x 0.64 mm (.021" x .025")

Bogen-Cutter  
Arch Cutter

Für weichen und harten Draht  
For soft and hard Wire  
Per fili duri, grossi e intrecciati  
Para alambre blando y duro  
Pour fil léger e dur

**LX-89**  
120 mm

Flachzangen - Scheren  
Nose Flat Pliers - Scissors  
Pinze a punte piatte - Forbici  
Alicates planos - Tijeras  
Pincès à mors plats - Ciseaux

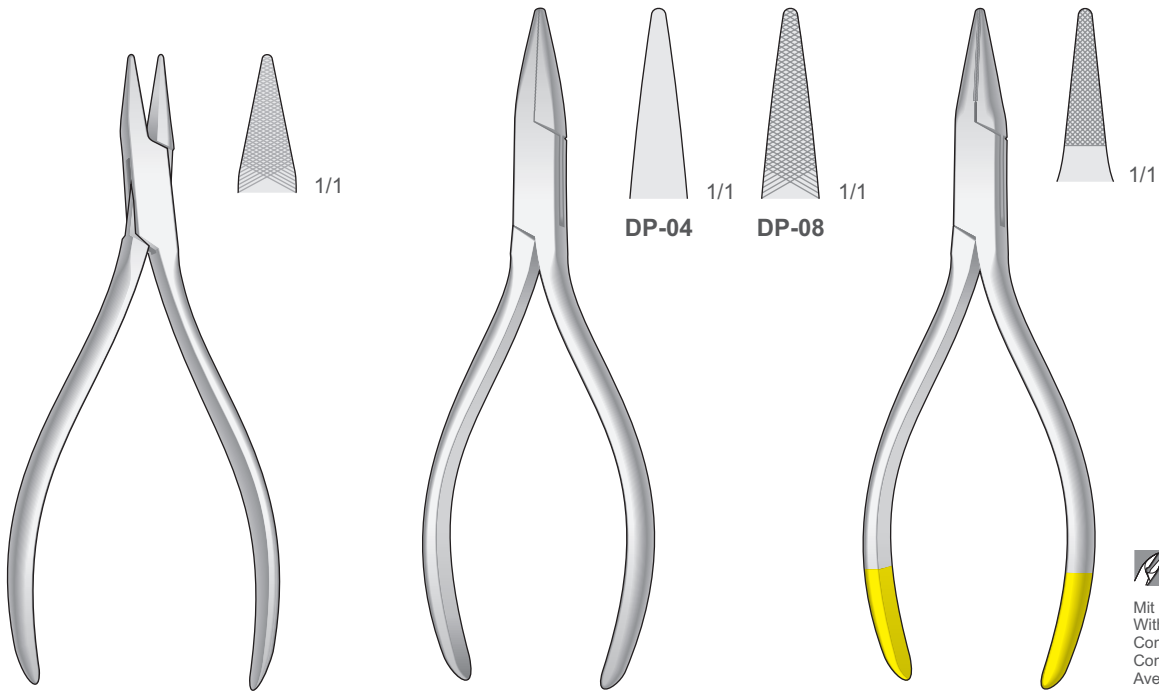

**DP-27**  
125 mm

**DP-04/DP-08**  
140 mm

**DP-08TC**  
140 mm



Mit Hartmetalleinsätzen  
With Hard Metal Inserts  
Con punte in metallo duro  
Con puntas de metal duro  
Avec mors en métal dur

Scheren für dünne Stahl-und Edelmetallbleche - Scissors for thin steel and precious metal sheets  
Forbici per lamine sottili di acciaio e metalli preziosi - Tijeras para láminas delgadas de acero y metales preciosos  
Ciseaux pour couper les feuilles de métaux

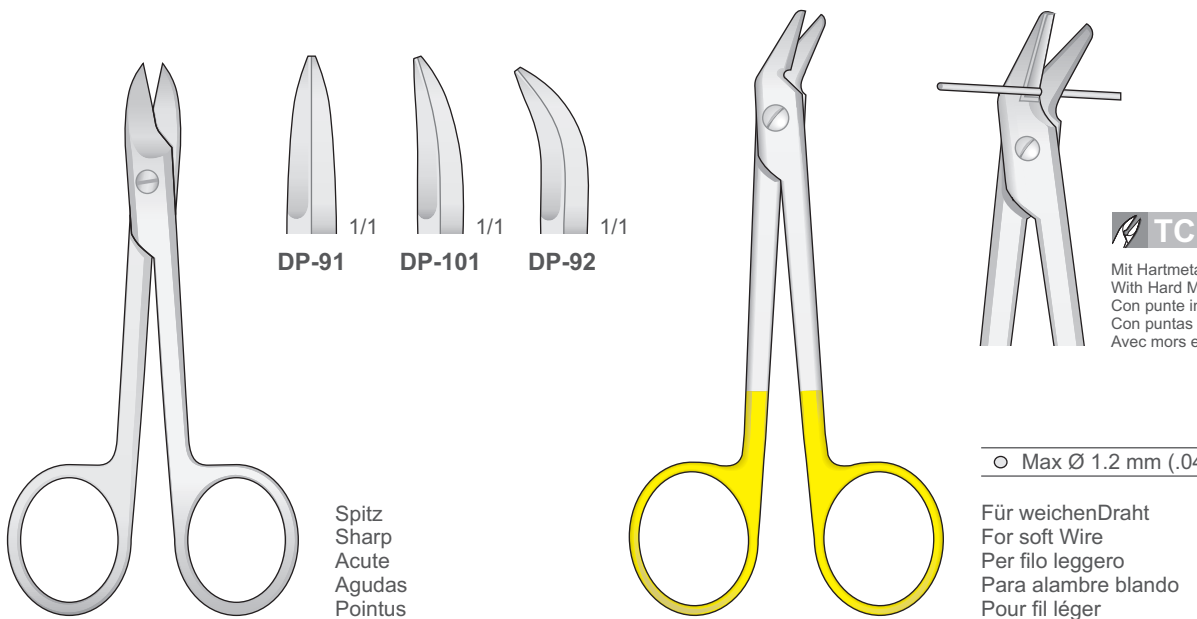

**BEEBE**  
**DP-91/DP-101**  
110 mm

Spitz  
Sharp  
Acute  
Agudas  
Pointus

**DP-120**  
120 mm



Mit Hartmetalleinsätzen  
With Hard Metal Inserts  
Con punte in metallo duro  
Con puntas de metal duro  
Avec mors en métal dur

○ Max Ø 1.2 mm (.048")

Für weichen Draht  
For soft Wire  
Per filo leggero  
Para alambre blando  
Pour fil léger

Instrumente für Mikro-Implantate  
Instruments for Micro Implants  
Strumenti per micro impianti  
Instrumentos para micro implantos  
Instruments pour les micro implantés

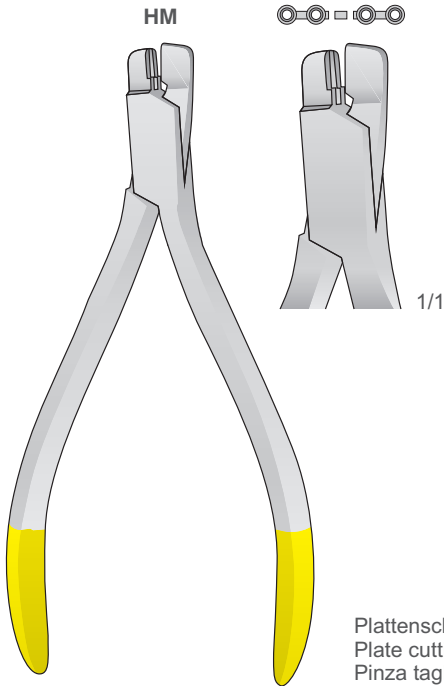

Plattenschneidezange  
Plate cutting Pliers  
Pinza taglia placche

**LS-155**  
115 mm

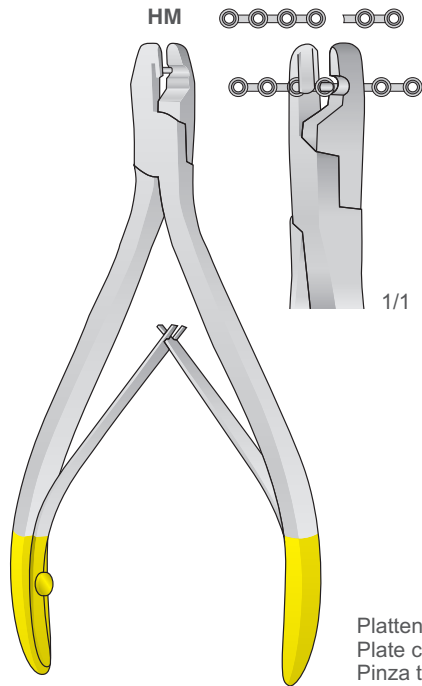

Plattenschneidezange  
Plate cutting Pliers  
Pinza taglia placche

**LS-156**  
110 mm

Dreipunkt-Biegezange  
Plate bending pliers  
Pinze piega placche

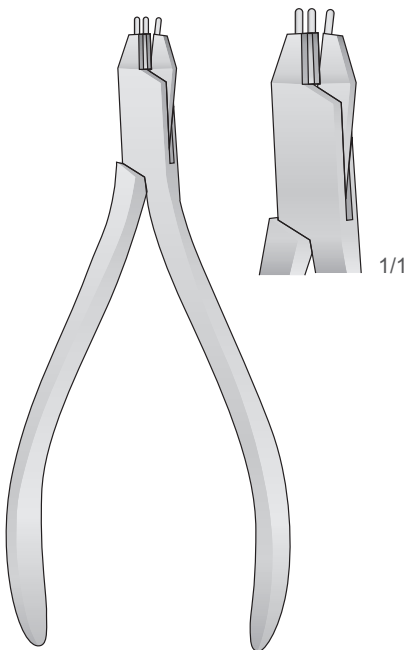

**LS-217**  
115 mm

Flachzange  
Flat-nose pliers  
Pinze piega placche piatta

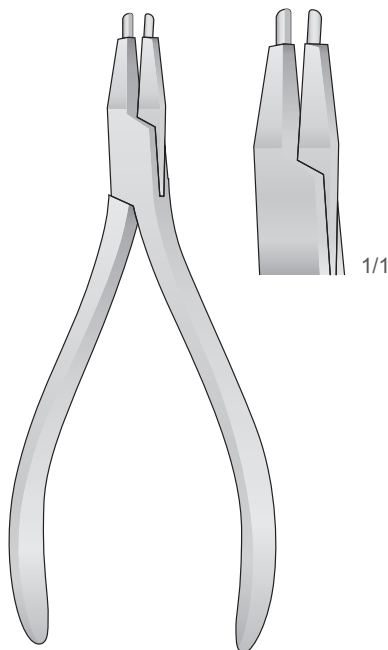

**LS-215**  
120 mm

Plattenschneidezange  
Plate cutting Pliers  
Pinza taglia placche

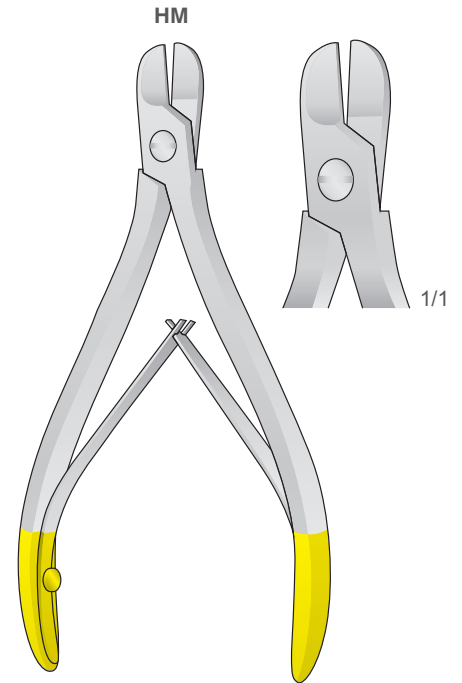

**LX-154**  
115 mm

Absaugkanülen  
Suctions tubes  
Cannule per aspirazione  
Cànulas aspiradoras  
Canules aspiratrices

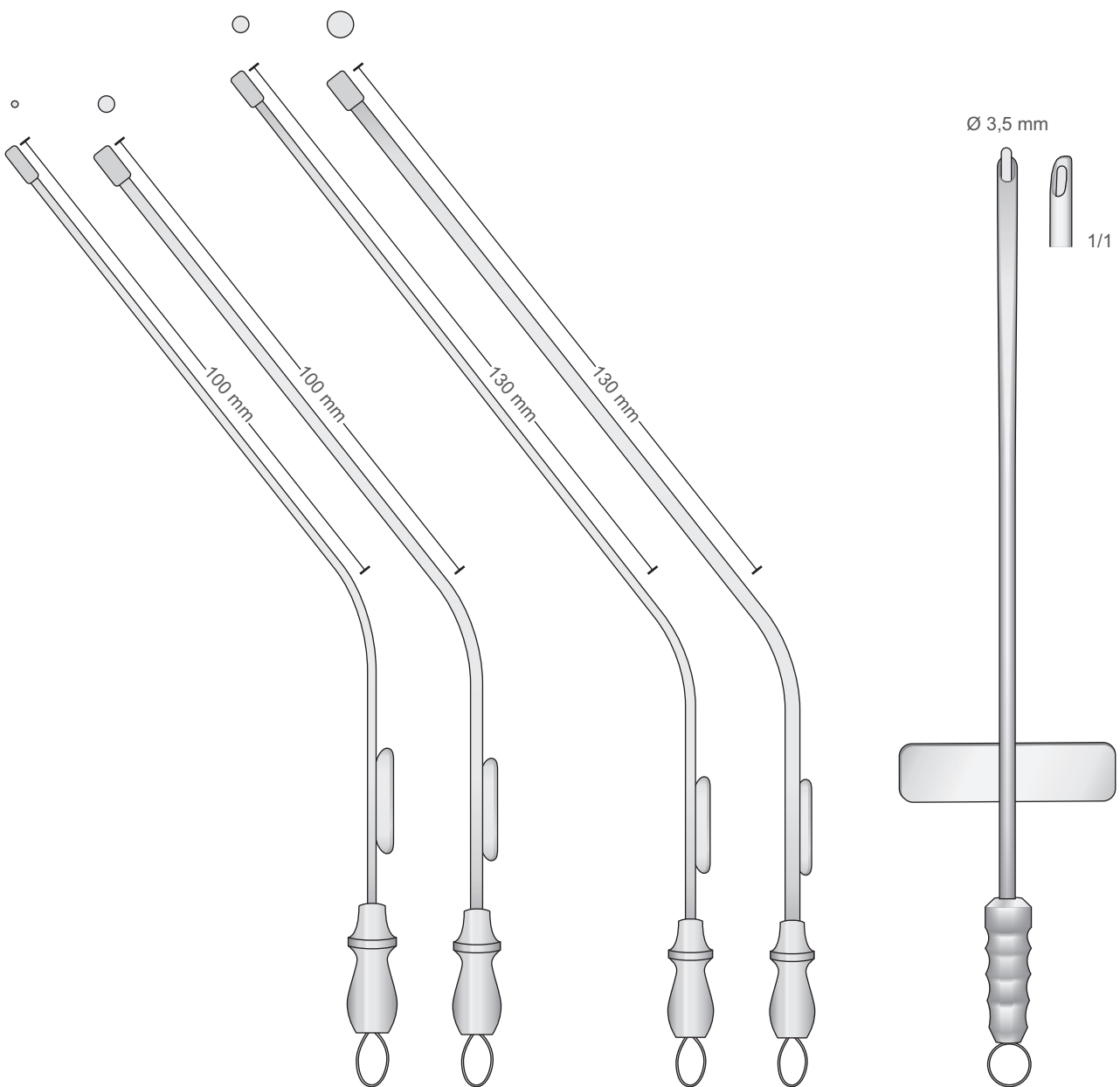

ROTAN  
**GF-25**  
Charr. 3  
Ø 1 mm

ROTAN  
**GF-27**  
Charr. 7  
Ø 2,5 mm

ROTAN  
**GF-28**  
Charr. 7  
Ø 2,5 mm

ROTAN  
**GF-24**  
Charr. 12  
Ø 4 mm

**GF-74**  
180 mm



Absaugkanülen  
Suctions tubes  
Cannule per aspirazione  
Cànulas aspiradoras  
Canules aspiratrices

House Saug- und Spülrohr, Luer Konus

Saugrohr  
Suction tube  
Tubo per aspirazione  
Tube d'aspiration

Spülrohr  
Irrigation tube  
Tubo per irrigazione  
Tube d'irrigation

Char. 3	= 1 mm
Char 5	= 1,7 mm
Char 7	= 2,5 mm
Char 10	= 3,3 mm
Char 12	= 4 mm
Char 14	= 4,6 mm

Char. 2	= 0,6 mm
Char 4	= 1,21 mm
Char 5	= 1,7 mm
Char 7	= 2,5 mm
Char 8	= 2,4 mm
Char 12	= 4 mm

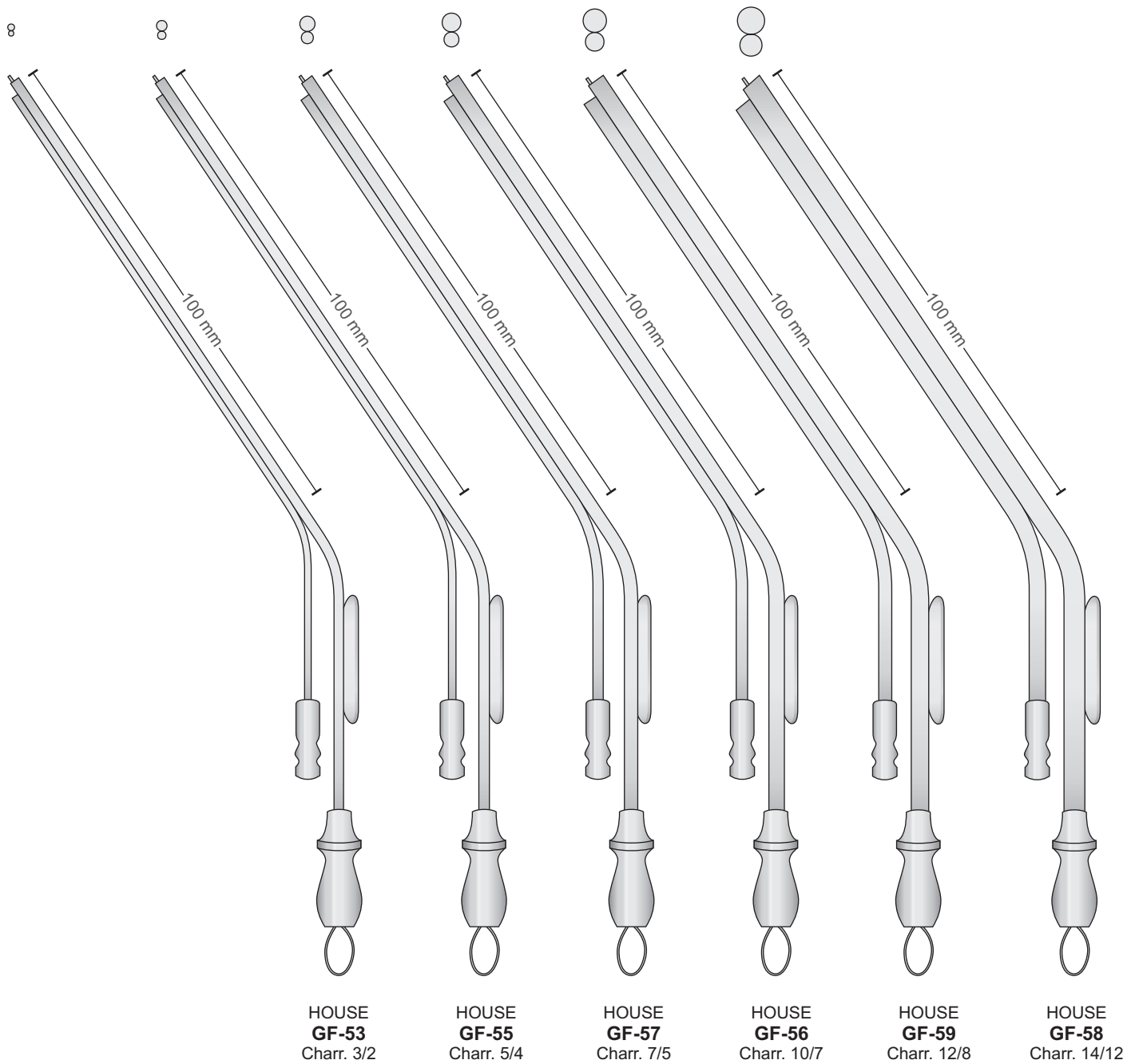



Alfabetisches Inhaltverzeichnis  
Alphabetical Index  
Indice alfabetico  
Indice alfabetico  
Index alphabetique

**BONTEMPI**  
**CHIRURGISCHE INSTRUMENTE**

Passion for excellence





<b>A</b>			
<b>ADSON</b> , Chirurgische Pinzetten	31, 33		
<b>ADSON-BROWN</b> , Chirurgische Pinzetten	32, 33		
<b>ASCH</b> , Knochenchirurgie	71		
<b>AUFRICHT</b> , Nasenhaken	40		
- Nasenraspeln	59		
<b>B</b>			
<b>BABBUSH</b> , Raspatorien	54		
<b>BABY CRILE-WOOD</b> , Nadelhalter	34		
<b>BEEBE</b> , Scheren für dünne Stahl-und Edelmetallbleche	76		
<b>BENNETT</b> , Raspatorien	55		
<b>BISHOP</b> , Lippen- und Wangenhalter	11		
<b>BONNEY</b> , Chirurgische Pinzetten	33		
<b>BRUENINGS</b> , Zungen Spatel	10		
<b>BUCHWALD</b> , Zungen Spatel	10		
<b>C</b>			
<b>CAPLAN</b> , Knochenchirurgie	71		
<b>CASTROVIEJO</b> , Nadelhalter	36		
- Meßinstrumente	3, 4		
<b>CAWOOD-MINNESOTA</b> , Lippen- und Wangenhalter	11		
<b>CHOMPRET</b> , Raspatorien	55		
<b>CINELLI</b> , Chirurgische Scheren	22		
<b>COLLIN</b> , Nasen Spekula	18		
<b>COLUMBIA</b> , Lippen- und Wangenhalter	12		
<b>CONVERSE</b> , Nadelhalter	34		
<b>COTTLE</b> , Feine Wundhaken	40		
- Elevatorien	49		
- Chirurgische Scheren	30		
- Hämmer	67		
- Osteotome	67		
- Raspatorien	49		
- Nasen Raspeln	59		
<b>COTTLE-KAZANJIAN</b> , Knochensplitterzangen	70		
<b>COTTLE-KNAPP</b> , Chirurgische Scheren	23		
<b>CRILE-WOOD</b> , Nadelhalter	34		
<b>CUSHING</b> , Chirurgische Pinzetten	33		
<b>D</b>			
<b>DANDY</b> , Arterienklemmen	37		
<b>DAUTREY-MUNRO</b> , Osteotome	66		
<b>DAVIS-BOYLE</b> , Mundsperrer	16		
<b>DE BAKEY</b> , Nadelhalter	35		
<b>DE MARTEL</b> , Arterienklemmen	38		
<b>DERF</b> , Nadelhalter	35		
<b>DINGMAN</b> , Unterkieferahlen	72		
- Elevatorien	50		
<b>DINGMANN</b> , Mundsperrer	15		
- Knochenchirurgie	71		
<b>DOCKHORN</b> , Lippen- und Wangenhalter	42		
<b>DUNN-DAUTREY</b> , Wundhaken	21		
<b>F</b>			
<b>FOMON</b> , Chirurgische Scheren	22, 30		
- Nasenraspeln	58		
<b>G</b>			
<b>GEMINI</b> , Arterienklemmen	38		
<b>GILLIES</b> , Feine Wundhaken	39		
- Elevatorien	50		
<b>GOLDMAN-FOX</b> , Chirurgische Scheren	24, 26		
<b>GOLDMANN</b> , Elevatorien	50		
<b>GORNEY</b> , Chirurgische Scheren	24		
<b>GUTHRIE</b> , Feine Wundhaken	39		
<b>H</b>			
<b>HALSEY</b> , Nadelhalter	34		
<b>HALSTED-MOSQUITO</b> , Arterienklemmen	37		
<b>HARGIS</b> , Wundhaken	51		
<b>HARTMANN</b> , Zungendrucker	10		
- Nasen Spekula	19		
<b>HEGAR</b> , Nadelhalter	35		
<b>HEISTER</b> , Mundsperrer	13		
<b>HEYMANN</b> , Chirurgische Scheren	30		
<b>HOUSE</b> , Absaugkanülen	79		
<b>HUMBY</b> , Dermatome	9		
<b>I</b>			
<b>IRIS</b> , Chirurgische Scheren	22, 26		
<b>J</b>			
<b>JACKSON-TESSIER</b> , Knochensplitterzangen	70		
<b>JAMESON</b> , Chirurgische Scheren	24		
<b>JOSEPH</b> , Feine Wundhaken	40		
- Chirurgische Scheren	23		
<b>K</b>			
<b>KAHN</b> , Chirurgische Scheren	24		
<b>KAYE</b> , Chirurgische Scheren	23		
<b>KELLY</b> , Chirurgische Scheren	23, 26		
<b>KEYES</b> , Dermatome	9		
<b>KILLIAN</b> , Knochensplitterzangen	70		
- Nasen Spekula	19		
<b>KILNER</b> , Feine Wundhaken	40		
- Chirurgische Scheren	22, 26		
<b>KILNER-DOUGHTY</b> , Mundsperrer	17		
<b>KOCHER-LANGENBECK</b> , Wundhaken	43		
<b>KROENIG</b> , Zungenspatel	10		
<b>L</b>			
<b>LAMBOTTE</b> , Osteotome	62		
<b>LEWIS</b> , Nasen Raspeln	59		
<b>LEXER</b> , Chirurgische Scheren	29		
<b>LUCAE</b> , Hämmer	67		
<b>LUNIATSCHEK</b> , Tamponstopfer	73		
<b>M</b>			
<b>MAGILL</b> , Diagnostik	20		
<b>MALTZ</b> , Nasen Raspeln	58		
<b>MASING</b> , Elevatorien	49		
<b>MATY</b> , Lippen- und Wangenhalter	12		
<b>MAYO</b> , Chirurgische Scheren	27		
- Präparierscheren	25		
<b>MAYO-HEGAR</b> , Nadelhalter	35		
<b>MAYO-LEXER</b> , Chirurgische Scheren	25		
<b>MAYO-STILLE</b> , Chirurgische Scheren	29		
<b>Mc INTOSH</b> , Diagnostik	20		
<b>Mc IVOR</b> , Mundsperrer	17		
<b>Mc KENTY</b> , Raspatorien	49		
<b>MERSHON</b> , Drahtpositionierer	73		
<b>METZENBAUM</b> , Chirurgische Scheren	25, 27		
<b>METZENBAUM-FINO</b> , Chirurgische Scheren	28		
<b>MIDDELDORPF</b> , Lippen- und Wangenhalter	12		

<b>MILLER-COLBURN</b> , Sinus Lift Küretten	56
<b>MINI-MALTZ</b> , Nasen Raspeln	58
<b>MINNESOTA</b> , Lippen- und Wangenhalter	11
<b>MISCH</b> , Ramus Retraktoren	44
<b>MITCHEL</b> , Raspatorien	55
<b>MOLT</b> , Mundsperrerr	13
- Raspatorien	55
<b>MOLT-DOYEN-COLLIN</b> , Mundsperrerr	13
<b>MOLT-DOYEN-JANSEN</b> , Mundsperrerr	13

**N**

<b>NEIVERT-ANDERSON</b> , Osteotome	65
-------------------------------------	----

**O**

<b>OBWEGESER</b> , Unterkieferahlen	72
- Wundhaken	43
- Wangenhalter	42
- Weichteilhaken	41
- Elevatorien	50
- Osteotome	62, 63, 64
- Raspatorien	52, 53
- Progenierinnen	44
<b>OBWEGESER-FREER</b> , Elevatorien	54

**P**

<b>POTTS-SMITH</b> , Chirurgische Pinzetten	32
---	----

**R**

<b>RAMUS RETRACTOR</b> , Wundhaken	43
<b>RAMUS</b> , Knochen-Spreizer	47
<b>REILL</b> , Repositionszangen	68
<b>ROCHESTER-PEAN</b> , Arterienklemmen	38
<b>ROSER KÖNIG</b> , Mundsperrerr	13
<b>ROTAN</b> , Absaugkanülen	78
<b>ROWE</b> , Repositionszangen	69

**S**

<b>SALZBURG</b> , Raspatorien	56
<b>SCHINK</b> , Dermatome	8
<b>SELDIN</b> , Raspatorien	54
<b>SHEA</b> , Chirurgische Scheren	22
<b>SHURE</b> , Drahtinstrumente	73
<b>SIGMOID NOTCH</b> , Intraorale Retraktoren	45
<b>SILVER</b> , Dermatome	8
- Osteotome	65
<b>STERNBERG</b> , Lippen- und Wangenhalter	12

**T**

<b>TESSIER</b> , Knochenchirurgie	71
- Wundhaken	51
- Beckenkamm Spatel	48
- Osteotome	60, 61
- Spreizzange	46
<b>TIECK-HALLE</b> , Nasen Spekula	18
<b>TOBOLD</b> , Zungendrücken	10

**W**

<b>WALTER</b> , Osteotome	60
<b>WALTON</b> , Raspatorien	54
<b>WASSMUND</b> , Lippen- und Wangenhalter	42
<b>WEBSTER</b> , Nadelhalter	34

<b>WHITEHEAD-JENNINGS</b> , Mundsperrerr	15
<b>WIEDER</b> , Zungendrücken	10
<b>WIEN</b> , Nasen Spekula	18
<b>WILLIGER</b> , Raspatorien	55

**Y**

<b>YOUNG</b> , Diagnostik	20
---------------------------	----

**Z**

<b>ZIELINSKY</b> , Meßinstrumente	3
-----------------------------------	---



<b>A</b>			
<b>ADSON</b> , Tissue Forceps	31, 33		
<b>ADSON-BROWN</b> , Tissue Forceps	32, 33		
<b>ASCH</b> , Bone Surgery	71		
<b>AUFRICHT</b> , Nasal Retractor	40		
- Nasal Rasps	59		
<b>B</b>			
<b>BABBUSH</b> , Raspatories	54		
<b>BABY CRILE-WOOD</b> , Needle Holders	34		
<b>BEEBE</b> , Scissors for thin steel and precious metal sheets	76		
<b>BENNETT</b> , Raspatories	55		
<b>BISHOP</b> , Lip and Cheek Retractors	11		
<b>BONNEY</b> , Tissue Forceps	33		
<b>BRUENINGS</b> , Tongue Spatulas	10		
<b>BUCHWALD</b> , Tongue Spatulas	10		
<b>C</b>			
<b>CAPLAN</b> , Bone Surgery	71		
<b>CASTROVIEJO</b> , Needle Holders	36		
- Measuring Instruments	3, 4		
<b>CAWOOD-MINNESOTA</b> , Lip and Cheek Retractors	11		
<b>CHOMPRET</b> , Raspatories	55		
<b>CINELLI</b> , Operating scissors	22		
<b>COLLIN</b> , Nasal specula	18		
<b>COLUMBIA</b> , Lip and Cheek Retractors	12		
<b>CONVERSE</b> , Needle Holders	34		
<b>COTTLE</b> , Delicate Retractors	40		
- Elevators	49		
- Operating Scissors	30		
- Mallets	67		
- Osteotomes	67		
- Raspatories	49		
- Nasal Rasps	59		
<b>COTTLE-KAZANJIAN</b> , Bone cutting forceps	70		
<b>COTTLE-KNAPP</b> , Operating Scissors	23		
<b>CRILE-WOOD</b> , Needle Holders	34		
<b>CUSHING</b> , Tissue Forceps	33		
<b>D</b>			
<b>DANDY</b> , Hemostatic Forceps	37		
<b>DAUTREY-MUNRO</b> , Osteotomes	66		
<b>DAVIS-BOYLE</b> , Mouth Gags	16		
<b>DE BAKEY</b> , Needle Holders	35		
<b>DE MARTEL</b> , Hemostatic Forceps	38		
<b>DERF</b> , Needle Holders	35		
<b>DINGMAN</b> , Maxillary Awls	72		
- Elevators	50		
<b>DINGMANN</b> , Mouth Gags	15		
- Bone Surgery	71		
<b>DOCKHORN</b> , Cheek Retractors	42		
<b>DUNN-DAUTREY</b> , Retractors	21		
<b>F</b>			
<b>FOMON</b> , Operating Scissors	22, 30		
- Nasal Rasps	58		
<b>G</b>			
<b>GEMINI</b> , Hemostatic Forceps	38		
<b>GILLIES</b> , Delicate Retractors	39		
- Elevators	50		
<b>GOLDMAN-FOX</b> , Operating Scissors	24, 26		
<b>GOLDMANN</b> , Elevators	50		
<b>GORNEY</b> , Operating Scissors	24		
<b>GUTHRIE</b> , Delicate Retractors	39		
<b>H</b>			
<b>HALSEY</b> , Needle Holders	34		
<b>HALSTED-MOSQUITO</b> , Hemostatic Forceps	37		
<b>HARGIS</b> , Retractors	51		
<b>HARTMANN</b> , Tongue Depressors	10		
- Nasal Specula	19		
<b>HEGAR</b> , Needle Holders	35		
<b>HEISTER</b> , Mouth Gags	13		
<b>HEYMANN</b> , Operating Scissors	30		
<b>HOUSE</b> , Suction Tubes	79		
<b>HUMBY</b> , Dermatomes	9		
<b>I</b>			
<b>IRIS</b> , Operating Scissors	22, 26		
<b>J</b>			
<b>JACKSON-TESSIER</b> , Bone cutting Forceps	70		
<b>JAMESON</b> , Operating Scissors	24		
<b>JOSEPH</b> , Delicate Retractors	40		
- Operating Scissors	23		
<b>K</b>			
<b>KAHN</b> , Operating Scissors	24		
<b>KAYE</b> , Operating Scissors	23		
<b>KELLY</b> , Operating Scissors	23, 26		
<b>KEYES</b> , Dermatomes	9		
<b>KILLIAN</b> , Bone cutting Forceps	70		
- Nasal Specula	19		
<b>KILNER</b> , Delicate Retractors	40		
- Operating Scissors	22, 26		
<b>KILNER-DOUGHTY</b> , Mouth Gags	17		
<b>KOCHER-LANGENBECK</b> , Retractors	43		
<b>KROENIG</b> , Tongue Spatulas	10		
<b>L</b>			
<b>LAMBOTTE</b> , Osteotomes	62		
<b>LEWIS</b> , Nasal Rasps	59		
<b>LEXER</b> , Operating Scissors	29		
<b>LUCAE</b> , Mallets	67		
<b>LUNIATSCHEK</b> , Gauze Packer	73		
<b>M</b>			
<b>MAGILL</b> , Diagnostics	20		
<b>MALTZ</b> , Nasal Rasps	58		
<b>MASING</b> , Elevators	49		
<b>MATY</b> , Lip and Cheek Retractors	12		
<b>MAYO</b> , Operating Scissors	27		
- Dissecting Scissors	25		
<b>MAYO-HEGAR</b> , Needle Holders	35		
<b>MAYO-LEXER</b> , Operating Scissors	25		
<b>MAYO-STILLE</b> , Operating Scissors	29		
<b>Mc INTOSH</b> , Diagnostics	20		
<b>Mc IVOR</b> , Mouth Gags	17		
<b>Mc KENTY</b> , Raspatories	49		
<b>MERSHON</b> , Wire Pusher	73		
<b>METZENBAUM</b> , Operating Scissors	25, 27		
<b>METZENBAUM-FINO</b> , Operating Scissors	28		
<b>MIDDELDORPF</b> , Lip and Cheek Retractors	12		

<b>MILLER-COLBURN</b> , Sinus Lift Curettes	56
<b>MINI-MALTZ</b> , Nasal Rasps	58
<b>MINNESOTA</b> , Lip and Cheek Retractors	11
<b>MISCH</b> , Ramus Retractors	44
<b>MITCHEL</b> , Raspatories	55
<b>MOLT</b> , Mouth Gags	13
- Raspatories	55
<b>MOLT-DOYEN-COLLIN</b> , Mouth Gags	13
<b>MOLT-DOYEN-JANSEN</b> , Mouth Gags	13
<b>N</b>	
<b>NEIVERT-ANDERSON</b> , Osteotomes	65
<b>O</b>	
<b>OBWEGESER</b> , Maxillary Awls	72
- Retractors	43
- Cheek Retractors	42
- Soft Tissue Retractors	41
- Elevators	50
- Osteotomes	62, 63, 64
- Raspatories	52, 53
- Channel Retractors	44
<b>OBWEGESER-FREER</b> , Elevators	54
<b>P</b>	
<b>POTTS-SMITH</b> , Tissue Forceps	32
<b>R</b>	
<b>RAMUS RETRACTOR</b> , Retractors	43
<b>RAMUS</b> , Bone Separators	47
<b>REILL</b> , Reposition Forceps	68
<b>ROCHESTER-PEAN</b> , Hemostatic Forceps	38
<b>ROSER KÖNIG</b> , Mouth Gags	13
<b>ROTAN</b> , Suction Tubes	78
<b>ROWE</b> , Reposition Forceps	69
<b>S</b>	
<b>SALZBURG</b> , Raspatories	56
<b>SCHINK</b> , Dermatomes	8
<b>SELDIN</b> , Raspatories	54
<b>SHEA</b> , Operating Scissors	22
<b>SHURE</b> , Wire Instruments	73
<b>SIGMOID NOTCH</b> , Intraoral Retractors	45
<b>SILVER</b> , Dermatomes	8
- Osteotomes	65
<b>STERNBERG</b> , Lip and Cheek Retractors	12
<b>T</b>	
<b>TESSIER</b> , Bone Surgery	71
- Retractors	51
- Iliac Crest Retractors	48
- Osteotomes	60, 61
- Spreading Forceps	46
<b>TIECK-HALLE</b> , Nasal Specula	18
<b>TOBOLD</b> , Tongue Depressors	10
<b>W</b>	
<b>WALTER</b> , Osteotomes	60
<b>WALTON</b> , Raspatories	54
<b>WASSMUND</b> , Cheek Retractors	42
<b>WEBSTER</b> , Needle Holders	34

<b>WHITEHEAD-JENNINGS</b> , Mouth Gags	15
<b>WIEDER</b> , Tongue Depressors	10
<b>WIEN</b> , Nasal Specula	18
<b>WILLIGER</b> , Raspatories	55
<b>Y</b>	
<b>YOUNG</b> , Diagnostics	20
<b>Z</b>	
<b>ZIELINSKY</b> , Measuring Instruments	3





<b>A</b>		<b>GOLDMANN</b> , Elevatori	50
<b>ADSON</b> , Pinzette chirurgiche	31, 33	<b>GORNEY</b> , Forbici chirurgiche	24
<b>ADSON-BROWN</b> , Pinzette chirurgiche	32, 33	<b>GUTHRIE</b> , Divaricatori delicati	39
<b>ASCH</b> , Chirurgia ossea	71	<b>H</b>	
<b>AUFRICHT</b> , Divaricatore nasale	40	<b>HALSEY</b> , Port'aghi	34
- Raspe nasali	59	<b>HALSTED-MOSQUITO</b> , Pinze emostatiche	37
<b>B</b>		<b>HARGIS</b> , Divaricatori	51
<b>BABBUSH</b> , Periostotomi	54	<b>HARTMANN</b> , Abbassalingua	10
<b>BABY CRILE-WOOD</b> , Port'aghi	34	- Speculum nasali	19
<b>BEEBE</b> , Forbici per lamine e fili d'acciaio	76	<b>HEGAR</b> , Port'aghi	35
<b>BENNETT</b> , Periostotomi	55	<b>HEISTER</b> , Apribocca	13
<b>BISHOP</b> , Divaricatore di labbra e guance	11	<b>HEYMANN</b> , Forbici chirurgiche	30
<b>BONNEY</b> , Pinzette chirurgiche	33	<b>HOUSE</b> , Cannule d'aspirazione	79
<b>BRUENINGS</b> , Spatole per lingua	10	<b>HUMBY</b> , Dermatomi	9
<b>BUCHWALD</b> , Spatole per lingua	10	<b>I</b>	
<b>C</b>		<b>IRIS</b> , Forbici chirurgiche	22, 26
<b>CAPLAN</b> , Chirurgia ossea	71	<b>J</b>	
<b>CASTROVIEJO</b> , Port'aghi	36	<b>JACKSON-TESSIER</b> , Pinze per ossa	70
- Strumenti per misura	3, 4	<b>JAMESON</b> , Forbici chirurgiche	24
<b>CAWOOD-MINNESOTA</b> , Divaricatore di labbra e guance	11	<b>JOSEPH</b> , Divaricatori delicati	40
<b>CHOMPRET</b> , Periostotomi	55	- Forbici chirurgiche	23
<b>CINELLI</b> , Forbici chirurgiche	22	<b>K</b>	
<b>COLLIN</b> , Speculum nasali	18	<b>KAHN</b> , Forbici chirurgiche	24
<b>COLUMBIA</b> , Divaricatore di labbra e guance	12	<b>KAYE</b> , Forbici chirurgiche	23
<b>CONVERSE</b> , Port'aghi	34	<b>KELLY</b> , Forbici chirurgiche	23, 26
<b>COTTLE</b> , Divaricatori delicati	40	<b>KEYES</b> , Dermatomi	9
- Elevatori	49	<b>KILLIAN</b> , Pinze per ossa	70
- Forbici chirurgiche	30	- Speculum nasali	19
- Martelli chirurgici	67	<b>KILNER</b> , Divaricatori delicati	40
- Osteotomi	67	- Forbici chirurgiche	22, 26
- Periostotomi	49	<b>KILNER-DOUGHTY</b> , Apribocca	17
- Raspe nasali	59	<b>KOCHER-LANGENBECK</b> , Divaricatore	43
<b>COTTLE-KAZANJIAN</b> , Pinze per ossa	70	<b>KROENIG</b> , Spatole per lingua	10
<b>COTTLE-KNAPP</b> , Forbici chirurgiche	23	<b>L</b>	
<b>CRILE-WOOD</b> , Port'aghi	34	<b>LAMBOTTE</b> , Osteotomi	62
<b>CUSHING</b> , Pinzette chirurgiche	33	<b>LEWIS</b> , Raspe nasali	59
<b>D</b>		<b>LEXER</b> , Forbici chirurgiche	29
<b>DANDY</b> , Pinze emostatiche	37	<b>LUCAE</b> , Martelli chirurgici	67
<b>DAUTREY-MUNRO</b> , Osteotomi	66	<b>LUNIATSCHEK</b> , Porta tamponi	73
<b>DAVIS-BOYLE</b> , Apribocca	16	<b>M</b>	
<b>DE BAKEY</b> , Port'aghi	35	<b>MAGILL</b> , Diagnostica	20
<b>DE MARTEL</b> , Pinze emostatiche	38	<b>MALTZ</b> , Raspe nasali	58
<b>DERF</b> , Port'aghi	35	<b>MASING</b> , Elevatori	49
<b>DINGMAN</b> , Aghi mandibolari	72	<b>MATY</b> , Divaricatore di labbra e guance	12
- Elevatori	50	<b>MAYO</b> , Forbici chirurgiche	27
<b>DINGMANN</b> , Apribocca	15	- Forbici per dissezione	25
- Chirurgia ossea	71	<b>MAYO-HEGAR</b> , Port'aghi	35
<b>DOCKHORN</b> , Divaricatore per guance	42	<b>MAYO-LEXER</b> , Forbici chirurgiche	25
<b>DUNN-DAUTREY</b> , Divaricatori	21	<b>MAYO-STILLE</b> , Forbici chirurgiche	29
<b>F</b>		<b>Mc INTOSH</b> , Diagnostica	20
<b>FOMON</b> , Forbici chirurgiche	22, 30	<b>Mc IVOR</b> , Apribocca	17
- Raspe nasali	58	<b>Mc KENTY</b> , Periostotomi	49
<b>G</b>		<b>MERSHON</b> , Posizionatore per filo	73
<b>GEMINI</b> , Pinze emostatiche	38	<b>METZENBAUM</b> , Forbici chirurgiche	25, 27
<b>GILLIES</b> , Divaricatori delicati	39	<b>METZENBAUM-FINO</b> , Forbici chirurgiche	28
- Elevatori	50	<b>MIDDELDORFF</b> , Divaricatore di labbra e guance	12
<b>GOLDMAN-FOX</b> , Forbici chirurgiche	24, 26		

<b>MILLER-COLBURN</b> , Curette per Sinus Lift	56
<b>MINI-MALTZ</b> , Raspe nasali	58
<b>MINNESOTA</b> , Divaricatore di labbra e guance	11
<b>MISCH</b> , Retrattori Ramus	44
<b>MITCHEL</b> , Periostotomi	55
<b>MOLT</b> , Apribocca	13
- Periostotomi	55
<b>MOLT-DOYEN-COLLIN</b> , Apribocca	13
<b>MOLT-DOYEN-JANSEN</b> , Apribocca	13

**N**

<b>NEIVERT-ANDERSON</b> , Osteotomi	65
-------------------------------------	----

**O**

<b>OBWEGESER</b> , Aghi mandibolari	72
- Divaricatore	43
- Divaricatore per guance	42
- Divaricatore per tessuti molli	41
- Elevatori	50
- Osteotomi	62, 63, 64
- Periostotomi	52, 53
- Separatori mandibolari	44
<b>OBWEGESER-FREER</b> , Elevatori	54

**P**

<b>POTTS-SMITH</b> , Pinzette chirurgiche	32
---	----

**R**

<b>RAMUS RETRACTOR</b> , Divaricatore	43
<b>RAMUS</b> , Separatore osseo	47
<b>REILL</b> , Pinze per riposizione	68
<b>ROCHESTER-PEAN</b> , Pinze emostatiche	38
<b>ROSER KÖNIG</b> , Apribocca	13
<b>ROTAN</b> , Cannule d'aspirazione	78
<b>ROWE</b> , Pinze per riposizione	69

**S**

<b>SALZBURG</b> , Periostotomi	56
<b>SCHINK</b> , Dermatomi	8
<b>SELDIN</b> , Periostotomi	54
<b>SHEA</b> , Forbici chirurgiche	22
<b>SHURE</b> , Strumenti per fili d'acciaio	73
<b>SIGMOID NOTCH</b> , Separatori intraorali	45
<b>SILVER</b> , Dermatomi	8
- Osteotomi	65
<b>STERNBERG</b> , Divaricatore di labbra e guance	12

**T**

<b>TESSIER</b> , Chirurgia ossea	71
- Divaricatori	51
- Divaricatori per cresta iliaca	48
- Osteotomi	60, 61
- Pinze per divaricare	46
<b>TIECK-HALLE</b> , Speculum nasali	18
<b>TOBOLD</b> , Abbassalingua	10

**W**

<b>WALTER</b> , Osteotomi	60
<b>WALTON</b> , Periostotomi	54
<b>WASSMUND</b> , Divaricatore per guance	42
<b>WEBSTER</b> , Port'aghi	34

<b>WHITEHEAD-JENNINGS</b> , Apribocca	15
<b>WIEDER</b> , Abbassalingua	10
<b>WIEN</b> , Speculum nasali	18
<b>WILLIGER</b> , Periostotomi	55

**Y**

<b>YOUNG</b> , Diagnostica	20
----------------------------	----

**Z**

<b>ZIELINSKY</b> , Strumenti per misura	3
---	---



<b>A</b>			
<b>ADSON</b> , Pinzas quirúrgicas	31, 33		
<b>ADSON-BROWN</b> , Pinzas quirúrgicas	32, 33		
<b>ASCH</b> , Pinzas para huesos	71		
<b>AUFRICHT</b> , Separadores nasales	40		
- Raspadores nasales	59		
<b>B</b>			
<b>BABBUSH</b> , Legras	54		
<b>BABY CRILE-WOOD</b> , Portaagujas	34		
<b>BEEBE</b> , Tijeras para láminas y alambre de acero	76		
<b>BENNETT</b> , Legras	55		
<b>BISHOP</b> , Separadores de labios y mejillas	11		
<b>BONNEY</b> , Pinzas quirúrgicas	33		
<b>BRUENINGS</b> , Espátulas bucales	10		
<b>BUCHWALD</b> , Espátulas bucales	10		
<b>C</b>			
<b>CAPLAN</b> , Pinzas para huesos	71		
<b>CASTROVIEJO</b> , Portaagujas	36		
- Instrumentos para medir	3, 4		
<b>CAWOOD-MINNESOTA</b> , Separadores de labios y mejillas	11		
<b>CHOMPRET</b> , Legras	55		
<b>CINELLI</b> , Tijeras para cirugía general	22		
<b>COLLIN</b> , Espéculos nasales	18		
<b>COLUMBIA</b> , Separadores de labios y mejillas	12		
<b>CONVERSE</b> , Portaagujas	34		
<b>COTTLE</b> , Separadores finos	40		
- Elevador	49		
- Tijeras para cirugía general	30		
- Martillos	67		
- Osteótomos	67		
- Legras	49		
- Raspadores nasales	59		
<b>COTTLE-KAZANJIAN</b> , Pinzas para huesos	70		
<b>COTTLE-KNAPP</b> , Tijeras para cirugía general	23		
<b>CRILE-WOOD</b> , Portaagujas	34		
<b>CUSHING</b> , Pinzas quirúrgicas	33		
<b>D</b>			
<b>DANDY</b> , Pinzas hemostáticas	37		
<b>DAUTREY-MUNRO</b> , Osteótomos	66		
<b>DAVIS-BOYLE</b> , Abre bocas	16		
<b>DE BAKEY</b> , Portaagujas	35		
<b>DE MARTEL</b> , Pinzas hemostáticas	38		
<b>DERF</b> , Portaagujas	35		
<b>DINGMAN</b> , Leznas maxilares	72		
- Elevador	50		
<b>DINGMANN</b> , Abre bocas	15		
- Pinzas para huesos	71		
<b>DOCKHORN</b> , Separadores de mejillas	42		
<b>DUNN-DAUTREY</b> , Separadores	21		
<b>F</b>			
<b>FOMON</b> , Tijeras para cirugía general	22, 30		
- Raspadores nasales	58		
<b>G</b>			
<b>GEMINI</b> , Pinzas hemostáticas	38		
<b>GILLIES</b> , Separadores finos	39		
- Elevador	50		
<b>GOLDMAN-FOX</b> , Tijeras para cirugía general	24, 26		
<b>GOLDMANN</b> , Elevador	50		
<b>GORNEY</b> , Tijeras para cirugía general	24		
<b>GUTHRIE</b> , Separadores finos	39		
<b>H</b>			
<b>HALSEY</b> , Portaagujas	34		
<b>HALSTED-MOSQUITO</b> , Pinzas hemostáticas	37		
<b>HARGIS</b> , Separadores	51		
<b>HARTMANN</b> , Bajalengua	10		
- Espéculos nasales	19		
<b>HEGAR</b> , Portaagujas	35		
<b>HEISTER</b> , Abre bocas	13		
<b>HEYMANN</b> , Tijeras para cirugía general	30		
<b>HOUSE</b> , Cánulas aspiradoras	79		
<b>HUMBY</b> , Dermátomos	9		
<b>I</b>			
<b>IRIS</b> , Tijeras para cirugía general	22, 26		
<b>J</b>			
<b>JACKSON-TESSIER</b> , Pinzas para huesos	70		
<b>JAMESON</b> , Tijeras para cirugía general	24		
<b>JOSEPH</b> , Separadores finos	40		
- Tijeras para cirugía general	23		
<b>K</b>			
<b>KAHN</b> , Tijeras para cirugía general	24		
<b>KAYE</b> , Tijeras para cirugía general	23		
<b>KELLY</b> , Tijeras para cirugía general	23, 26		
<b>KEYES</b> , Dermátomos	9		
<b>KILLIAN</b> , Pinzas para huesos	70		
- Espéculos nasales	19		
<b>KILNER</b> , Separadores finos	40		
- Tijeras para cirugía general	22, 26		
<b>KILNER-DOUGHTY</b> , Abre bocas	17		
<b>KOCHER-LANGENBECK</b> , Separadores	43		
<b>KROENIG</b> , Espátulas bucales	10		
<b>L</b>			
<b>LAMBOTTE</b> , Osteótomos	62		
<b>LEWIS</b> , Raspadores nasales	59		
<b>LEXER</b> , Tijeras para cirugía general	29		
<b>LUCAE</b> , Martillos	67		
<b>LUNIATSCHEK</b> , Tamponador	73		
<b>M</b>			
<b>MAGILL</b> , Diagnóstico	20		
<b>MALTZ</b> , Raspadores nasales	58		
<b>MASING</b> , Elevador	49		
<b>MATY</b> , Separadores de labios y mejillas	12		
<b>MAYO</b> , Tijeras para cirugía general	27		
- Tijeras para preparaciones	25		
<b>MAYO-HEGAR</b> , Portaagujas	35		
<b>MAYO-LEXER</b> , Tijeras para cirugía general	25		
<b>MAYO-STILLE</b> , Tijeras para cirugía general	29		
<b>Mc INTOSH</b> , Diagnóstico	20		
<b>Mc IVOR</b> , Abre bocas	17		
<b>Mc KENTY</b> , Legras	49		
<b>MERSHON</b> , Instrumentos para posicionar alambre	73		
<b>METZENBAUM</b> , Tijeras para cirugía general	25, 27		
<b>METZENBAUM-FINO</b> , Tijeras para cirugía general	28		
<b>MIDDELDORPF</b> , Separadores de labios y mejillas	12		

<b>MILLER-COLBURN</b> , Curetas para Sinus Lift	56
<b>MINI-MALTZ</b> , Raspadores nasales	58
<b>MINNESOTA</b> , Separadores de labios y mejillas	11
<b>MISCH</b> , Separadores Ramus	44
<b>MITCHEL</b> , Legras	55
<b>MOLT</b> , Abrebocas	13
- Legras	55
<b>MOLT-DOYEN-COLLIN</b> , Abrebocas	13
<b>MOLT-DOYEN-JANSEN</b> , Abrebocas	13
<b>N</b>	
<b>NEIVERT-ANDERSON</b> , Osteòtomos	65
<b>O</b>	
<b>OBWEGESER</b> , Leznas maxilares	72
- Separadores	43
- Separadores de mejillas	42
- Separadores para partes blandas	41
- Elevador	50
- Osteòtomos	62, 63, 64
- Legras	52, 53
- Separadores mandibulares	44
<b>OBWEGESER-FREER</b> , Elevador	54
<b>P</b>	
<b>POTTS-SMITH</b> , Pinzas quirùrgicas	32
<b>R</b>	
<b>RAMUS RETRACTOR</b> , Separadores	43
<b>RAMUS</b> , Separadores de hueso	47
<b>REILL</b> , Pinzas para reposicionar	68
<b>ROCHESTER-PEAN</b> , Pinzas hemostàticas	38
<b>ROSER KÖNIG</b> , Abrebocas	13
<b>ROTAN</b> , Cànulas aspiradoras	78
<b>ROWE</b> , Pinzas para reposicionar	69
<b>S</b>	
<b>SALZBURG</b> , Legras	56
<b>SCHINK</b> , Dermàtomos	8
<b>SELDIN</b> , Legras	54
<b>SHEA</b> , Tijeras para cirugia general	22
<b>SHURE</b> , Instrumentos para alambre	73
<b>SIGMOID NOTCH</b> , Separadores intra orales	45
<b>SILVER</b> , Dermàtomos	8
- Osteòtomos	65
<b>STERNBERG</b> , Separadores de labios y mejillas	12
<b>T</b>	
<b>TESSIER</b> , Pinzas para huesos	71
- Separadores	51
- Separadores para cresta iliaca	48
- Osteòtomos	60, 61
- Separadores	46
<b>TIECK-HALLE</b> , Espéculos nasales	18
<b>TOBOLD</b> , Bajalengua	10
<b>W</b>	
<b>WALTER</b> , Osteòtomos	60
<b>WALTON</b> , Legras	54
<b>WASSMUND</b> , Separadores de mejillas	42
<b>WEBSTER</b> , Portaagujas	34

<b>WHITEHEAD-JENNINGS</b> , Abrebocas	15
<b>WIEDER</b> , Bajalengua	10
<b>WIEN</b> , Espéculos nasales	18
<b>WILLIGER</b> , Legras	55
<b>Y</b>	
<b>YOUNG</b> , Diagnòstico	20
<b>Z</b>	
<b>ZIELINSKY</b> , Instrumentos para medir	3



<b>A</b>			
<b>ADSON</b> , Pincés chirurgicales	31, 33	<b>GOLDMANN</b> , Elévateur	50
<b>ADSON-BROWN</b> , Pincés chirurgicales	32, 33	<b>GORNEY</b> , Ciseaux chirurgicaux	24
<b>ASCH</b> , Chirurgie osseuse	71	<b>GUTHRIE</b> , Ecarteurs fins	39
<b>AUFRICHT</b> , Ecarteurs nasaux	40		
- Râpes nasales	59	<b>H</b>	
<b>B</b>		<b>HALSEY</b> , Porte aiguilles	34
<b>BABBUSH</b> , Rugines	54	<b>HALSTED-MOSQUITO</b> , Pincés hémostatiques	37
<b>BABY CRILE-WOOD</b> , Porte aiguilles	34	<b>HARGIS</b> , Ecarteurs	51
<b>BEEBE</b> , Ciseaux pour couper les feuilles de métaux	76	<b>HARTMANN</b> , Abaisse-langues	10
<b>BENNETT</b> , Rugines	55	- Spéculums nasaux	19
<b>BISHOP</b> , Ecarteurs de lèvres et de joues	11	<b>HEGAR</b> , Porte aiguilles	35
<b>BONNEY</b> , Pincés chirurgicales	33	<b>HEISTER</b> , Ouvre-bouche	13
<b>BRUENINGS</b> , Spatules à langue	10	<b>HEYMANN</b> , Ciseaux chirurgicaux	30
<b>BUCHWALD</b> , Spatules à langue	10	<b>HOUSE</b> , Canules aspiratrices	79
<b>C</b>		<b>HUMBY</b> , Dermatomes	9
<b>CAPLAN</b> , Chirurgie osseuse	71	<b>I</b>	
<b>CASTROVIEJO</b> , Porte aiguilles	36	<b>IRIS</b> , Ciseaux chirurgicaux	22, 26
- Instruments à mesurer	3, 4	<b>J</b>	
<b>CAWOOD-MINNESOTA</b> , Ecarteurs de lèvres et de joues	11	<b>JACKSON-TESSIER</b> , Pincés coupantes à os	70
<b>CHOMPRET</b> , Rugines	55	<b>JAMESON</b> , Ciseaux chirurgicaux	24
<b>CINELLI</b> , Ciseaux chirurgicaux	22	<b>JOSEPH</b> , Ecarteurs fins	40
<b>COLLIN</b> , Spéculums nasaux	18	- Ciseaux chirurgicaux	23
<b>COLUMBIA</b> , Ecarteurs de lèvres et de joues	12	<b>K</b>	
<b>CONVERSE</b> , Porte aiguilles	34	<b>KAHN</b> , Ciseaux chirurgicaux	24
<b>COTTLE</b> , Ecarteurs fins	40	<b>KAYE</b> , Ciseaux chirurgicaux	23
- Elévateur	49	<b>KELLY</b> , Ciseaux chirurgicaux	23, 26
- Ciseaux chirurgicaux	30	<b>KEYES</b> , Dermatomes	9
- Maillets	67	<b>KILLIAN</b> , Pincés coupantes à os	70
- Ostéotomes	67	- Spéculums nasaux	19
- Rugines	49	<b>KILNER</b> , Ecarteurs fins	40
- Râpes nasales	59	- Ciseaux chirurgicaux	22, 26
<b>COTTLE-KAZANJIAN</b> , Pincés coupantes à os	70	<b>KILNER-DOUGHTY</b> , Ouvre-bouche	17
<b>COTTLE-KNAPP</b> , Ciseaux chirurgicaux	23	<b>KOCHER-LANGENBECK</b> , Ecarteurs	43
<b>CRILE-WOOD</b> , Porte aiguilles	34	<b>KROENIG</b> , Spatules à langue	10
<b>CUSHING</b> , Pincés chirurgicales	33	<b>L</b>	
<b>D</b>		<b>LAMBOTTE</b> , Ostéotomes	62
<b>DANDY</b> , Pincés hémostatiques	37	<b>LEWIS</b> , Râpes nasales	59
<b>DAUTREY-MUNRO</b> , Ostéotomes	66	<b>LEXER</b> , Ciseaux chirurgicaux	29
<b>DAVIS-BOYLE</b> , Ouvre-bouche	16	<b>LUCAE</b> , Maillets	67
<b>DE BAKEY</b> , Porte aiguilles	35	<b>LUNIATSCHEK</b> , Porte-tampons	73
<b>DE MARTEL</b> , Pincés hémostatiques	38	<b>M</b>	
<b>DERF</b> , Porte aiguilles	35	<b>MAGILL</b> , Diagnostic	20
<b>DINGMAN</b> , Alènes maxillaires	72	<b>MALTZ</b> , Râpes nasales	58
- Elévateur	50	<b>MASING</b> , Elévateur	49
<b>DINGMANN</b> , Ouvre-bouche	15	<b>MATY</b> , Ecarteurs de lèvres et de joues	12
- Chirurgie osseuse	71	<b>MAYO</b> , Ciseaux chirurgicaux	27
<b>DOCKHORN</b> , Ecarteurs de joues	42	- Ciseaux à dissection	25
<b>DUNN-DAUTREY</b> , Ecarteurs	21	<b>MAYO-HEGAR</b> , Porte aiguilles	35
<b>F</b>		<b>MAYO-LEXER</b> , Ciseaux chirurgicaux	25
<b>FOMON</b> , Ciseaux chirurgicaux	22, 30	<b>MAYO-STILLE</b> , Ciseaux chirurgicaux	29
- Râpes nasales	58	<b>Mc INTOSH</b> , Diagnostic	20
<b>G</b>		<b>Mc IVOR</b> , Ouvre-bouche	17
<b>GEMINI</b> , Pincés hémostatiques	38	<b>Mc KENTY</b> , Rugines	49
<b>GILLIES</b> , Ecarteurs fins	39	<b>MERSHON</b> , Positionneur à fil	73
- Elévateur	50	<b>METZENBAUM</b> , Ciseaux chirurgicaux	25, 27
<b>GOLDMAN-FOX</b> , Ciseaux chirurgicaux	24, 26	<b>METZENBAUM-FINO</b> , Ciseaux chirurgicaux	28
		<b>MIDDELDORFF</b> , Ecarteurs de lèvres et de joues	12

<b>MILLER-COLBURN</b> , Curettes pour Sinus Lift	56
<b>MINI-MALTZ</b> , Râpes nasales	58
<b>MINNESOTA</b> , Ecarteurs de lèvres et de joues	11
<b>MISCH</b> , Ecarteurs Ramus	44
<b>MITCHEL</b> , Rugines	55
<b>MOLT</b> , Ouvre-bouche	13
- Rugines	55
<b>MOLT-DOYEN-COLLIN</b> , Ouvre-bouche	13
<b>MOLT-DOYEN-JANSEN</b> , Ouvre-bouche	13

## N

<b>NEIVERT-ANDERSON</b> , Ostéotomes	65
--------------------------------------	----

## O

<b>OBWEGESER</b> , Alénes maxillaires	72
- Ecarteurs	43
- Ecarteurs de joues	42
- Ecarteurs pour parties molles	41
- Elévateur	50
- Ostéotomes	62, 63, 64
- Rugines	52, 53
- Ecarteurs mandibulaires	44
<b>OBWEGESER-FREER</b> , Elévateur	54

## P

<b>POTTS-SMITH</b> , Pincés chirurgicales	32
---	----

## R

<b>RAMUS RETRACTOR</b> , Ecarteurs	43
<b>RAMUS</b> , Ecarteurs à os	47
<b>REILL</b> , Pincés à réposition	68
<b>ROCHESTER-PEAN</b> , Pincés hémostatiques	38
<b>ROSER KÖNIG</b> , Ouvre-bouche	13
<b>ROTAN</b> , Canules aspiratrices	78
<b>ROWE</b> , Pincés à réposition	69

## S

<b>SALZBURG</b> , Rugines	56
<b>SCHINK</b> , Dermatomes	8
<b>SELDIN</b> , Rugines	54
<b>SHEA</b> , Ciseaux chirurgicaux	22
<b>SHURE</b> , Instruments pour les feuilles de métaux	73
<b>SIGMOID NOTCH</b> , Rétracteurs intra-oraux	45
<b>SILVER</b> , Dermatomes	8
- Ostéotomes	65
<b>STERNBERG</b> , Ecarteurs de lèvres et de joues	12

## T

<b>TESSIER</b> , Chirurgie osseuse	71
- Ecarteurs	51
- Rétracteur iliaque	48
- Ostéotomes	60, 61
- Pince à écarter	46
<b>TIECK-HALLE</b> , Spéculums nasaux	18
<b>TOBOLD</b> , Abaisse-langues	10

## W

<b>WALTER</b> , Ostéotomes	60
<b>WALTON</b> , Rugines	54
<b>WASSMUND</b> , Ecarteurs de joues	42
<b>WEBSTER</b> , Porte aiguilles	34

<b>WHITEHEAD-JENNINGS</b> , Ouvre-bouche	15
<b>WIEDER</b> , Abaisse-langues	10
<b>WIEN</b> , Spéculums nasaux	18
<b>WILLIGER</b> , Rugines	55

## Y

<b>YOUNG</b> , Diagnostic	20
---------------------------	----

## Z

<b>ZIELINSKY</b> , Instruments à mesurer	3
--	---

Nummernverzeichnis  
Alphanumerical Index  
Indice alfanumerico  
Indice alfanumerico  
Index alphanumerique

**BONTEMPI**  
**CHIRURGISCHE INSTRUMENTE**

Passion for excellence







718-215	54	BT-214	40	DO-110	64	FB-119	38
718-216	54	BT-215	40	DO-111	49	FB-120	38
718-M9	56	BT-216	40	DO-112	64		
		BT-217	40	DO-118	66		
AA-S105	20	BT-220	48	DO-119	66	FD-22	36
AA-S503	20	BT-221	48	DO-120	64	FD-25	36
		BT-222	48	DO-121	64	FD-27	36
AT-12	55	BT-223	48	DO-122	64	FD-28	36
		BT-245	40	DO-125	45	FD-29	36
BB-46	7	BT-273	40	DO-126	45	FD-128	36
BB-48	7			DO-128	50		
		CH-1	55	DO-138	53	FG-1	22
BD-30	31	CH-2	55	DO-139	53	FG-1TC	26
BD-31	31	CH-3	55	DO-140	67	FG-2	22
BD-70	31	CH-4	55	DO-141	67	FG-2TC	26
BD-71	31			DO-142	44	FG-8	30
BD-72	31	CU-MC1	56	DO-143	67	FG-23	24
BD-73	31			DO-150	67	FG-24	24
BD-90	32	DE-10	8	DO-157	71	FG-41	30
BD-92	32	DE-11	8	DO-158	67	FG-43	22
BD-93	32	DE-12	8	DO-160	60	FG-90	22
BD-141	32	DE-13	8	DO-161	60	FG-91	22
BD-177	31	DE-14	8	DO-162	60	FG-93	22
BD-178	31			DO-177	58	FG-95	22
BD-221	33	DO-08	10	DO-178	59	FG-110	70
BD-222	33	DO-09	10	DO-179	58	FG-111	70
BD-223	33	DO-10	69	DO-198	21	FG-112	23
BD-224	33	DO-11	69	DO-199	21	FG-113	23
BD-226	33	DO-12	69	DO-203	66	FG-121	22
BD-227	33	DO-13	69	DO-205	66	FG-124	24
BD-230	33	DO-14	69	DO-206	66	FG-127	24
BD-231	33	DO-15	69	DO-206	66	FG-147	23
BD-250	33	DO-18	62	DO-236	55	FG-148	23
BD-251	33	DO-19	48	DO-237	55	FG-165	30
BD-252	33	DO-28	50	DO-240	56	FG-166	30
BD-253	33	DO-29	48	DO-241	56	FG-187	24
BD-287	32	DO-30	72	DO-247	47	FG-190	24
BD-288	32	DO-31	72	DO-248	47	FG-191	24
BD-289	32	DO-32	72	DO-257	66	FG-191	24
BD-290	32	DO-34	65	DO-258	66	FG-218	23
BD-291	32	DO-35	65	DO-260	66	FG-219	23
BD-292	32	DO-36	65	DO-261	66		
		DO-40	42	DO-262	66	FK-1	23
BT-15	39	DO-41	44	DO-276	65	FK-1TC	26
BT-16	39	DO-42	51	DO-277	65	FK-2	23
BT-60	43	DO-43	51	DO-278	65	FK-2TC	26
BT-67	43	DO-45	45	DO-283	51		
BT-68	43	DO-46	45	DO-284	51	FL-01	67
BT-69	42	DO-47	49	DO-288	50	FL-10M	67
BT-80	12	DO-48	40	DO-291	50	FL-29	62
BT-81	12	DO-59	52	DO-292	54	FL-34	62
BT-82	12	DO-60	49	DO-293	54	FL-36	62
BT-92	41	DO-63	52	DO-294	54	FL-41	62
BT-93	41	DO-65	52	DO-295	54	FL-42	62
BT-94	41	DO-67	52	DO-296	54	FL-43	62
BT-95	41	DO-68	50	DO-323	72	FL-44	62
BT-96	41	DO-69	50	DO-324	72	FL-45	62
BT-100	41	DO-70	59			FL-46	62
BT-134	42	DO-71	59	DP-04	76	FL-47	62
BT-135	42	DO-75	59	DP-08	76	FL-48	62
BT-152	41	DO-76	59	DP-08TC	76	FL-49	62
BT-153	41	DO-79	58	DP-27	76	FL-94	62
BT-154	41	DO-80	58	DP-50	73	FL-95	62
BT-155	41	DO-81	58	DP-91	76	FL-96	62
BT-156	41	DO-82	58	DP-92	76	FL-97	62
BT-157	41	DO-83	58	DP-101	76	FL-98	62
BT-158	44	DO-84	66	DP-120	76	FL-99	62
BT-159	44	DO-85	66	DP-124	73	FL-104	67
BT-203	39	DO-85	66	DP-725	3	FL-147	62
BT-204	39	DO-94	21			FL-148	62
BT-207	39	DO-95	21	EN-M1	57	FL-149	62
BT-208	39	DO-96	21	EN-M2	57	FL-150	9
BT-210	40	DO-97	21	EN-M3	57	FL-151	9
BT-211	40	DO-101	53	EN-M4	57	FL-152	9
BT-212	40	DO-102	53	EN-M5	57	FL-153	9
BT-213	40	DO-103	53	EN-M6	57	FL-155	9
		DO-108	18	EN-M7	57	FL-156	9

FL-157	9	FO-242	68	OM-05	10	OM-171	17
FL-158	9			OM-06	10	OM-172	17
FL-159	9	GFC-TC	26	OM-08	10		
FL-307	61			OM-10	18		
FL-308	61	GF-24	78	OM-12	20		
FL-309	61	GF-25	78	OM-13	20		
FL-310	61	GF-27	78	OM-14	20		
FL-311	61	GF-28	78	OM-16	10		
FL-312	61	GF-53	79	OM-18	10		
FL-313	61	GF-55	79	OM-20	19		
FL-314	61	GF-56	79	OM-21	19		
FL-315	61	GF-57	79	OM-22	19		
FL-316	61	GF-58	79	OM-23	19		
FL-334	63	GF-59	79	OM-24	19		
FL-335	63	GF-74	78	OM-26	19		
FL-336	63			OM-30	18		
FL-337	63	KO-12	49	OM-31	19		
FL-401	60	KO-20	54	OM-40	13		
FL-402	60	KO-22	54	OM-40R	13		
FL-403	60	KO-23	54	OM-41	13		
FL-404	60	KO-46	49	OM-41R	13		
FL-405	60	KO-58	55	OM-42	13		
FL-411	60			OM-44	20		
FL-412	60	LB-10	6	OM-45	20		
FL-413	60	LB-11	6	OM-48	18		
FL-414	60	LB-12	6	OM-49	18		
FL-415	60	LB-12D	6	OM-50	12		
FL-416	60	LB-13	6	OM-52	12		
		LB-15	6	OM-55	11		
FM-1	25	LB-15A	6	OM-56	18		
FM-2	25	LB-15C	6	OM-57	18		
FM-3	25	LB-18	6	OM-59	18		
FM-4	25	LB-20	6	OM-60	13		
FM-24	25	LB-21	6	OM-61	11		
FM-25	25	LB-22	6	OM-62	13		
FM-66	27	LB-23	6	OM-66	11		
FM-67	27	LB-24	6	OM-66B	11		
FM-68	27	LB-25	6	OM-67	12		
FM-69	27	LB-36	6	OM-72	14		
FM-79	25	LB-361	7	OM-80	11		
FM-98	28	LB-362	7	OM-81	11		
FM-99	28	LB-363	7	OM-87	11		
FM-118	26	LB-364	7	OM-88	11		
FM-119	26	LB-365	7	OM-90	12		
FM-130	29	LB-366	7	OM-97	12		
FM-131	29	LB-367	7	OM-98	11		
FM-132	29	LB-368	7	OM-99	11		
FM-133	29	LB-369	7	OM-100	11		
FM-134	29			OM-110	15		
FM-135	29	LK-12	28	OM-112	15		
FM-136	29			OM-113	15		
FM-137	29	LS-08	3	OM-114	15		
FM-141	27	LS-09	3	OM-136	15		
FM-161	27	LS-155	77	OM-137	15		
FM-163	27	LS-156	77	OM-138	15		
FM-201	28	LS-215	77	OM-139	15		
FM-202	28	LS-217	77	OM-140	16		
FM-203	28			OM-141	16		
FM-204	28	LX-88	75	OM-142	16		
FM-206	28	LX-89	75	OM-143	16		
FM-208	28	LX-98	75	OM-144	16		
FM-350	26	LX-99	75	OM-145	16		
		LX-102	74	OM-146	16		
FO-63	70	LX-103	74	OM-150	16		
FO-64	68	LX-105	74	OM-151	16		
FO-66	68	LX-141	74	OM-152	16		
FO-68	68	LX-154	77	OM-153	16		
FO-95	70	MA-B1	5	OM-154	16		
FO-130	71	MA-B2	5	OM-155	16		
FO-131	71	MA-B3	5	OM-156	16		
FO-131S	71	MA-B3M	5	OM-160	17		
FO-137	70	MA-B4	5	OM-161	17		
FO-143	71	MA-B7	5	OM-162	17		
FO-144	71	MA-B7K	5	OM-163	17		
FO-240	68			OM-164	17		
FO-241	68	OM-04	10	OM-170	17		





**Bontempi**

SURGICAL INSTRUMENTS  
PORTUGAL

Passion for Excellence

Rua Poeta de Bocage, nº 15-F, Letra J  
1600-240 Lisboa  
T: + 351 210 968 925  
F: + 351 210 968 925

[info@bontempiportugal.pt](mailto:info@bontempiportugal.pt)  
[www.bontempiportugal.pt](http://www.bontempiportugal.pt)