



Bontempi

SURGICAL INSTRUMENTS
PORTUGAL

Passion for Excellence

Dental-Katalog
Dental Catalogue
Catalogo dentale
Catálogo dental
Catalogue dentaire



.1

Zahnzangen
Extracting Forceps
Pinze per estrazione
Pinzas de extracciòn
Daviers

Zahnärztliche Chirurgie
Dental surgery
Chirurgia dentale
Cirugia dental
Chirurgie dentaire

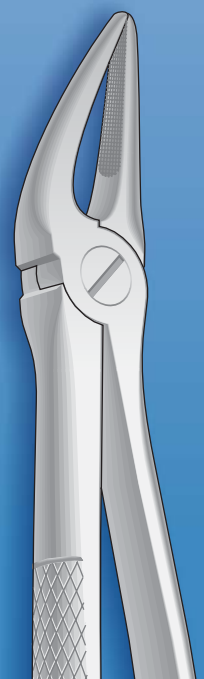



Zahnzangen, Englische Form
Extracting Forceps, English Pattern
Pinze per estrazione, Forma Inglese
Pinzas da extracciòn, Forma Inglesa
Daviers, Forme Anglaise

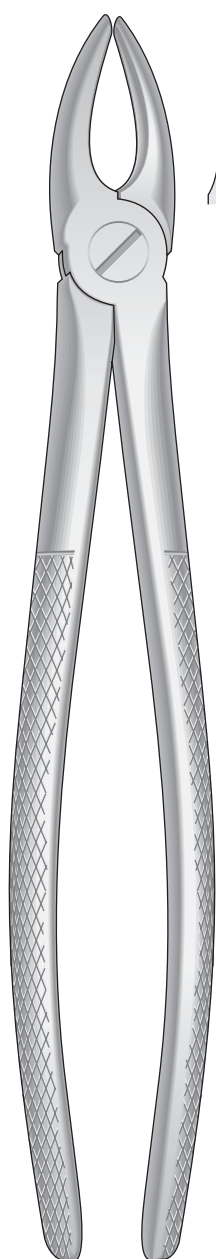

1
Fig. 1

Obere Schneide- und Eckzähne
Upper Incisors and cuspids
Incisivi e canini superiori
Incisivos y caninos superiores
Incisives et canines supérieures

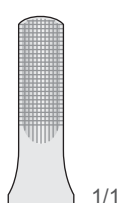

1/1

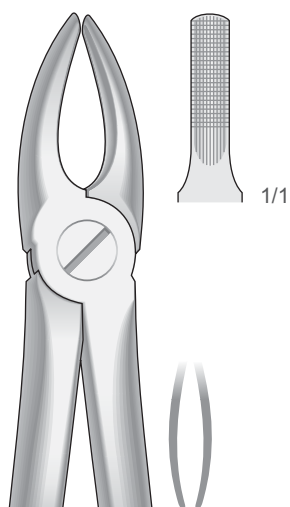

2
Fig. 2

Obere Schneide- und Eckzähne
Upper Incisors and cuspids
Incisivi e canini superiori
Incisivos y caninos superiores
Incisives et canines supérieures

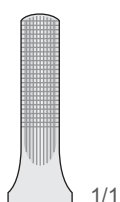

1/1

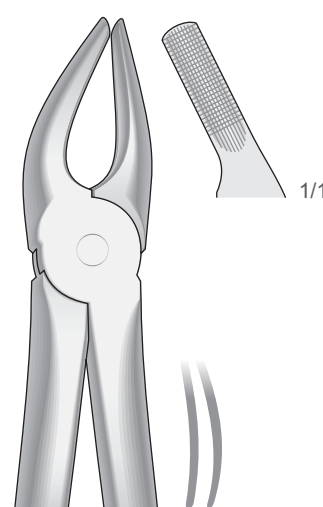

7
Fig. 7

Obere Prämolaren
Upper premolars
Premolari superiori
Premolares superiores
Prémolaires supérieures

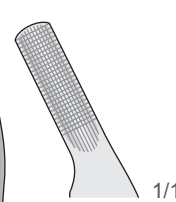

1/1

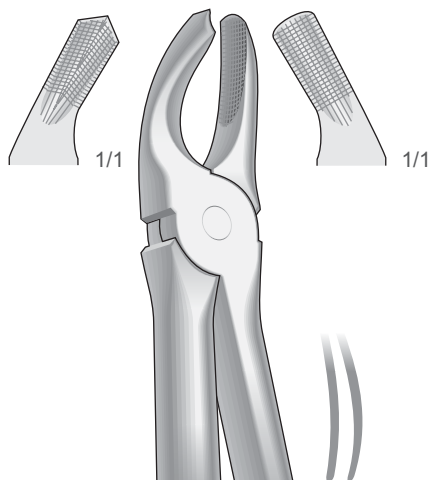

17
Fig. 17

Obere Molaren, rechts
Upper molars, right
Molari superiori, destra
Molares superiores, derechos
Molaires supérieures, droites

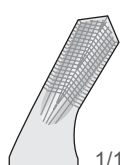

1/1

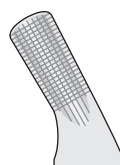

1/1

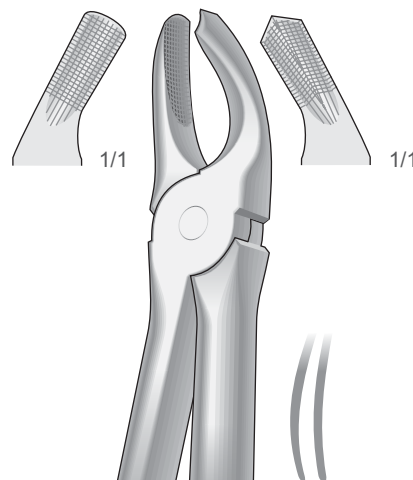

18
Fig. 18

Obere Molaren, links
Upper molars, left
Molari superiori, sinistra
Molares superiores, izquierdos
Molaires supérieures, gauches

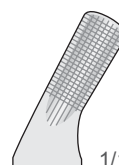

1/1

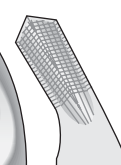

1/1



Zahnzangen, Englische Form
Extracting Forceps, English Pattern
Pinze per estrazione, Forma Inglese
Pinzas da extracciòn, Forma Inglesa
Daviers, Forme Anglaise

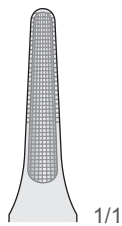
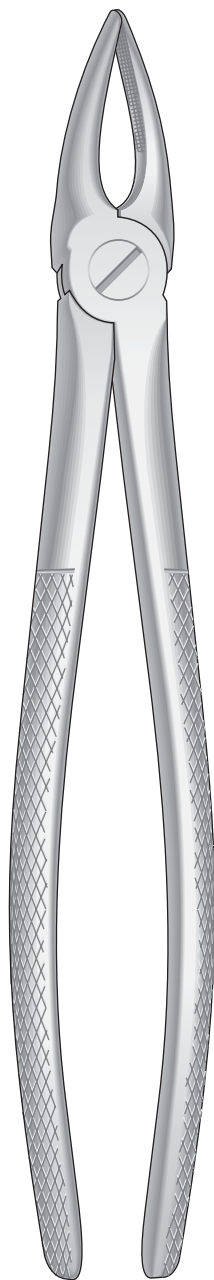

Obere Wurzeln und Schneidezähne
Upper Roots and incisors
Radici e incisivi superiori
Raíces y incisivos superiores
Racines et incisives supérieures

29
Fig. 29

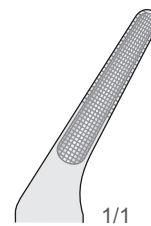

Obere Wurzeln
Upper Roots
Radici superiori
Raíces superiores
Racines supérieures

30
Fig. 30



Zahnzangen, Englische Form
Extracting Forceps, English Pattern
Pinze per estrazione, Forma Inglese
Pinzas da extracciòn, Forma Inglesa
Daviers, Forme Anglaise

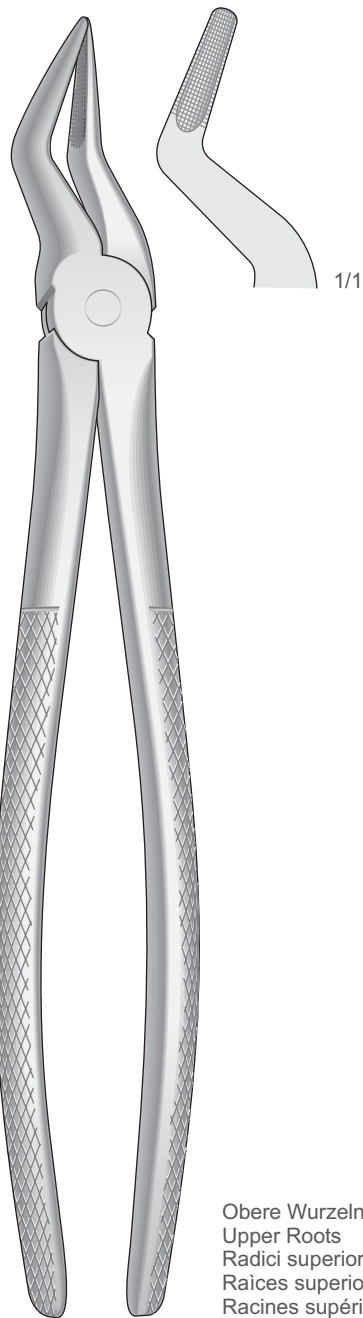

51
Fig. 51

Obere Wurzeln
Upper Roots
Radici superiori
Raíces superiores
Racines supérieures

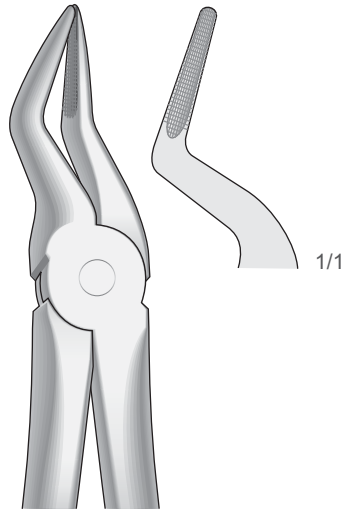

51A
Fig. 51A

Obere Wurzeln
Upper Roots
Radici superiori
Raíces superiores
Racines supérieures

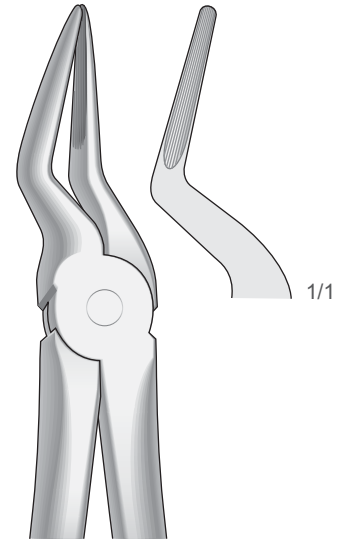

51L
Fig. 51AL

Obere Wurzeln
Upper Roots
Radici superiori
Raíces superiores
Racines supérieures

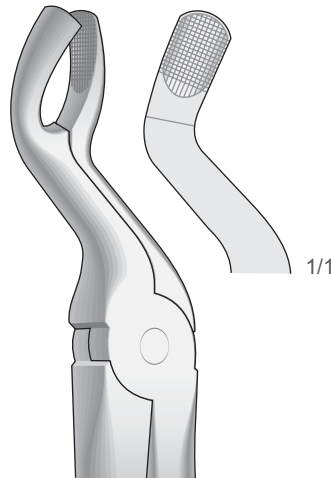

67A
Fig. 67A

Obere Dritte Molaren - Für Obere Weisheitszähne
Upper molars - For Upper wisdom teeth
Ottavi superiori - Per denti del giudizio superiori
Molares superiores - Para muelas del juicio superiores
Molaires supérieures - Pour dents de sagesse supérieures



Zahnzangen, Englische Form
Extracting Forceps, English Pattern
Pinze per estrazione, Forma Inglese
Pinzas da extracciòn, Forma Inglesa
Daviers, Forme Anglaise

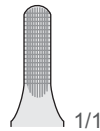
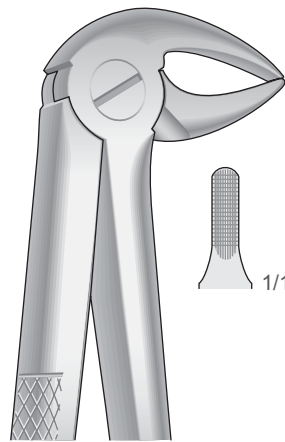

33
Fig. 33

Untere Prämolaren, Schneidezähne und Wurzeln
Lower incisors, premolars and roots
Incisivi, premolari e radici inferiori
Incisivos, premolares y raíces inferiores
Incisives, prémolaires et racines inférieures

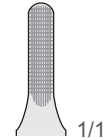
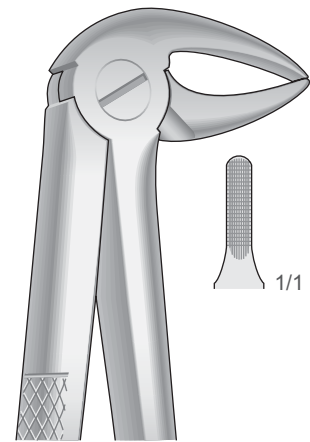

33A
Fig. 33A

Untere Wurzeln, schlankes Maul
Lower roots, Slender jaw
Radici inferiori, morso stretto
Raíces inferiores, boca estrecha
Racines inférieures, avec un bec très fin

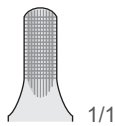
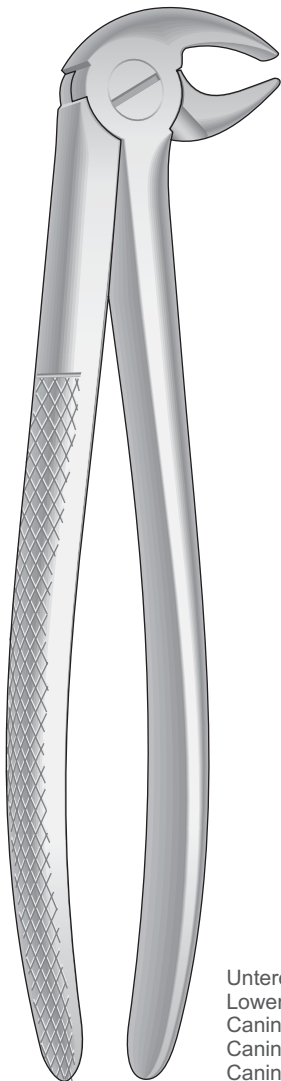

13
Fig. 13

Untere Eckzähne und Prämolaren
Lower cuspids and premolars
Canini e premolari inferiori
Caninos y premolares inferiores
Canines et prémolaires inférieures

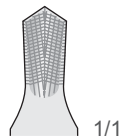
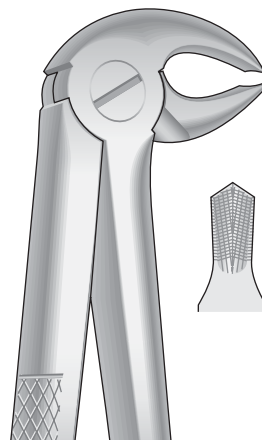

22
Fig. 22

Untere Molaren
Lower molars
Molari inferiori
Molares inferiores
Molaires inférieures

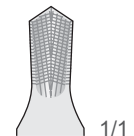
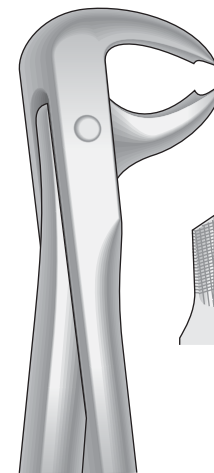

73
Fig. 73

Untere Molaren
Lower molars
Molari inferiori
Molares inferiores
Molaires inférieures



Zahnzangen, Englische Form
Extracting Forceps, English Pattern
Pinze per estrazione, Forma Inglese
Pinzas da extracciòn, Forma Inglesa
Daviers, Forme Anglaise

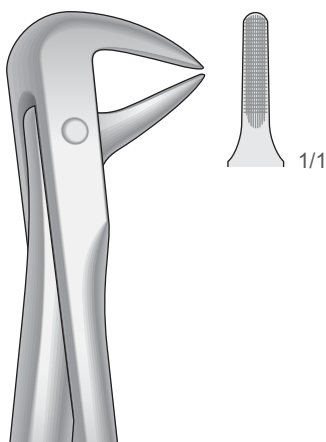

74N
Fig. 74N

Untere Wurzeln, schneide-und Eckzähne
Lower roots, Incisors and bicuspid
Radici, incisivi e canini inferiori
Raíces, incisivos y caninos inferiores
Racines, incisives et canines inférieures

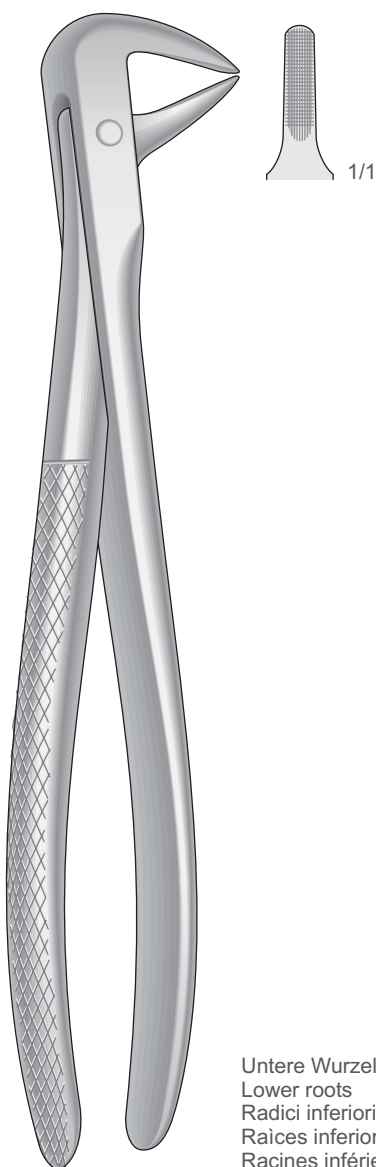

74
Fig. 74

Untere Wurzeln
Lower roots
Radici inferiori
Raíces inferiores
Racines inférieures

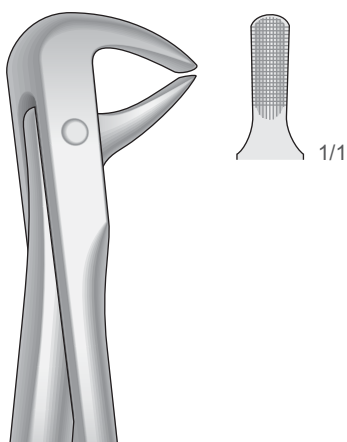

75
Fig. 75

Untere Eckzähne und Prämolaren
Lower Cuspids and bicuspid
Canini e premolari inferiori
Caninos y premolares inferiores
Canines et prémolaires inférieures

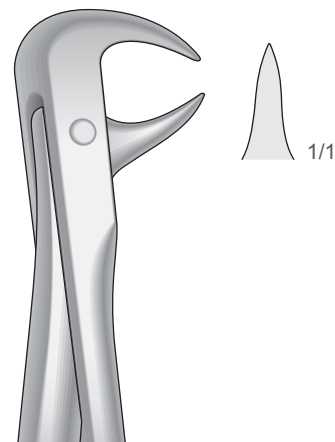

86A
Fig. 86A

Untere Molaren
Lower molars
Molari inferiori
Molares inferiores
Molaires inférieures



Zahnzangen, Englische Form
Extracting Forceps, English Pattern
Pinze per estrazione, Forma Inglese
Pinzas da extracciòn, Forma Inglesa
Daviers, Forme Anglaise

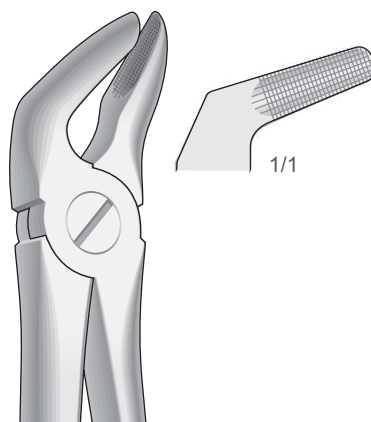

8
Fig. 8

Untere Prämolaren
Lower premolars
Premolari inferiori
Premolares inferiores
Prémolaires inférieures

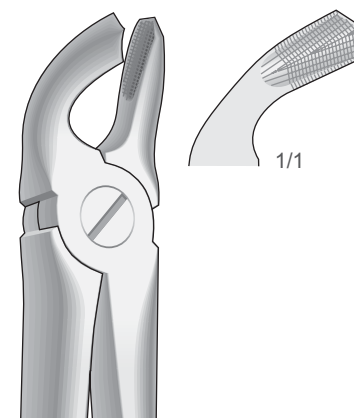

21
Fig. 21

Untere Weisheitszähne und Molaren
Lower wisdom teeth and molars
Denti del giudizio e molari inferiori
Muelas del juicio y Molares inferiores
Dents de sagesse et molaires inférieures

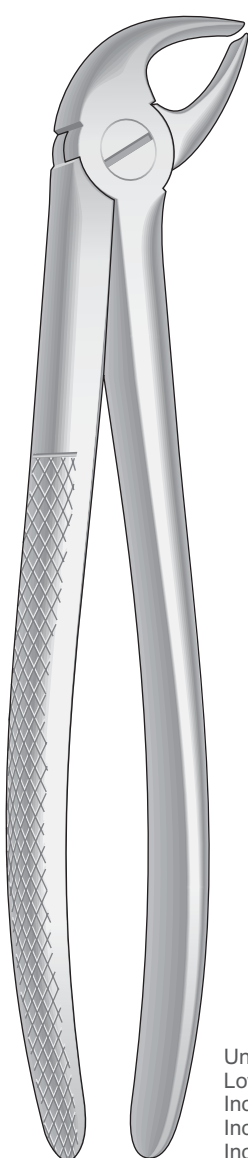
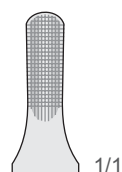

4
Fig. 4

Untere Schneide- und Eckzähne
Lower Incisors and cuspids
Incisivi e canini inferiori
Incisivos y caninos inferiores
Incisives et canines inférieures

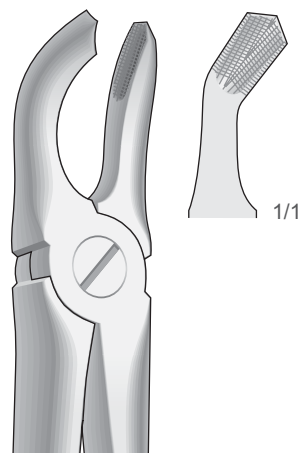

79
Fig. 79

Untere Weisheitszähne
Lower wisdom teeth
Denti del giudizio inferiori
Muelas del juicio inferiores
Dent de sagesse inférieures

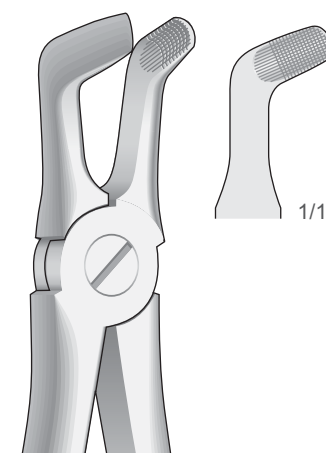

79A
Fig. 79A

Untere Molaren und Weisheitszähne
Lower molars and wisdom teeth
Molari e denti del giudizio inferiori
Muelas y muelas del juicio inferiores
Molaires et dent de sagesse inférieures



Zahnzangen, Englische Form
Extracting Forceps, English Pattern
Pinze per estrazione, Forma Inglese
Pinzas da extracciòn, Forma Inglesa
Daviers, Forme Anglaise

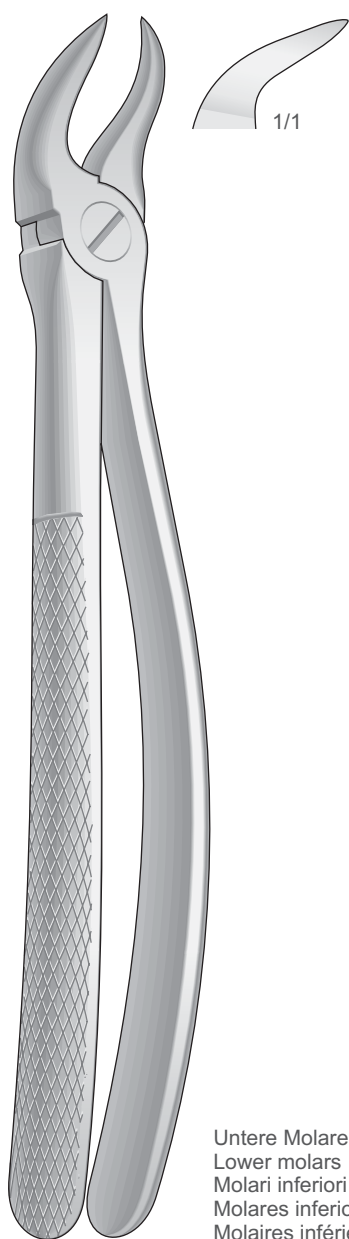

87
Fig. 87

Untere Molaren
Lower molars
Molari inferiori
Molares inferiores
Molaires inférieures

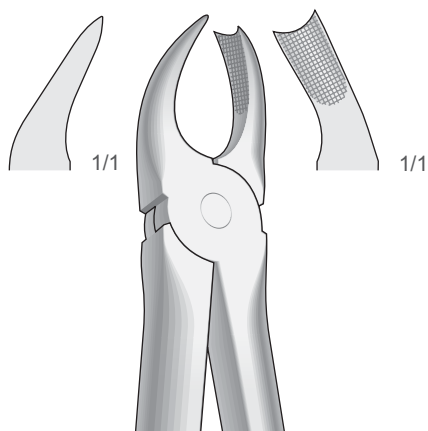

89
Fig. 89

Obere Molaren, rechts
Upper molars, right
Molari superiori, destra
Molares superiores, derechos
Molaires supérieures, droites

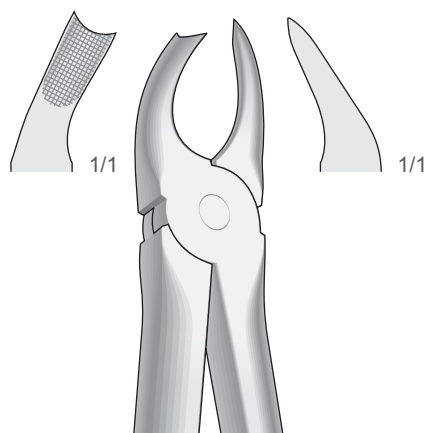

90
Fig. 90

Obere Molaren, links
Upper molars, left
Molari superiori, sinistra
Molares superiores, izquierdos
Molaires supérieures, gauches



Zahnzangen, Englische Form
Extracting Forceps, English Pattern
Pinze per estrazione, Forma Inglese
Pinzas da extracciòn, Forma Inglesa
Daviers, Forme Anglaise

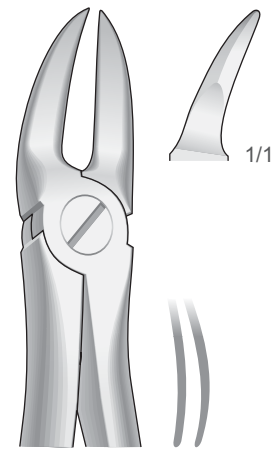

55
Fig. 55

Zum Trennen oberer Molarenwurzeln
For separating upper molar roots
Per radici dei molari superiori, presa in profondità
Para partir raices de molares superiores, profundo
Pour séparer les racines des molaires supérieures

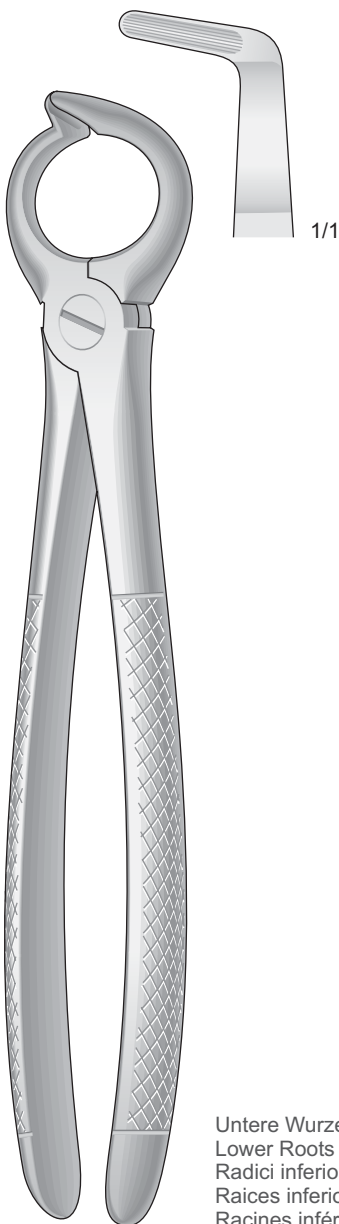

68
Fig. 68

Untere Wurzeln
Lower Roots
Radici inferiori
Raices inferiores
Racines inférieures

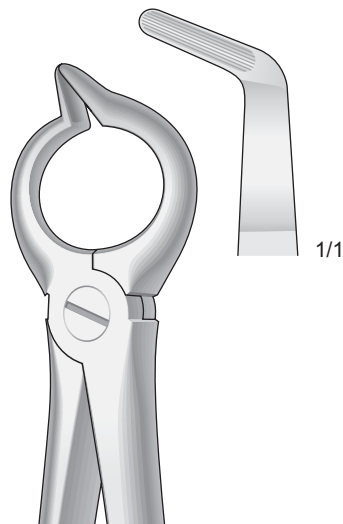

68A
Fig. 68A

Untere Wurzeln
Lower Roots
Radici inferiori
Raices inferiores
Racines inférieures

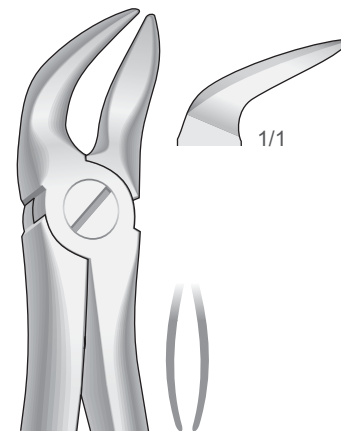

56
Fig. 56

Zum Trennen Unterer Molarenwurzeln
For separating lower molar roots
Per radici dei molari inferiori, presa in profondità
Para partir raices de molares inferiores, profundo
Pour séparer les racines des molaires inférieures



Zahnzangen, Englische Form
Extracting Forceps, English Pattern
Pinze per estrazione, Forma Inglese
Pinzas da extracciòn, Forma Inglesa
Daviers, Forme Anglaise

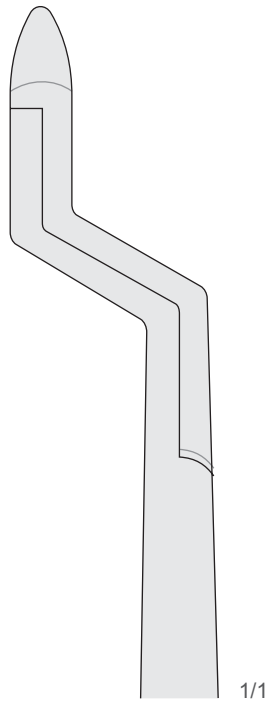
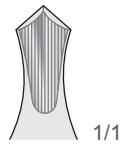
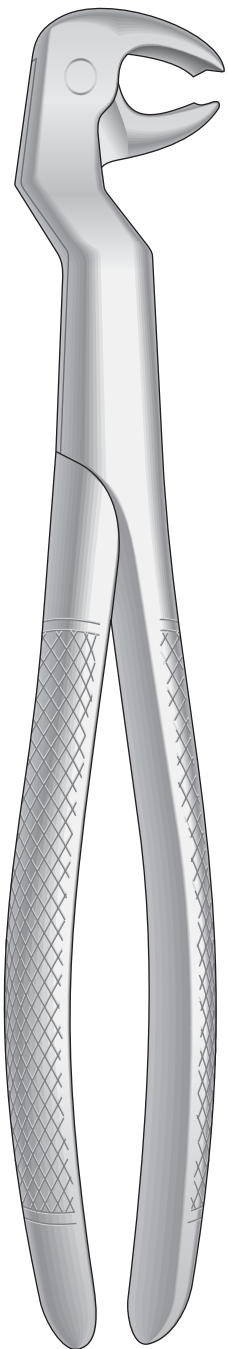

Untere Molaren und Weisheitszähne, rechts
Lower molars and wisdom teeth, right
Molari e denti del giudizio inferiori, a destra
Molares y muelas del juicio inferiores, derecha
Molaires et dent de sagesse inférieures, droites

**ROUTURIER
22 1/2 R**

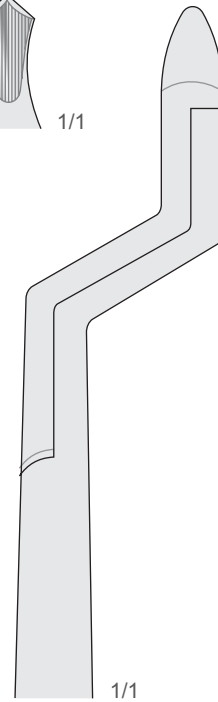
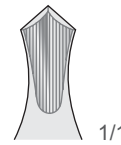
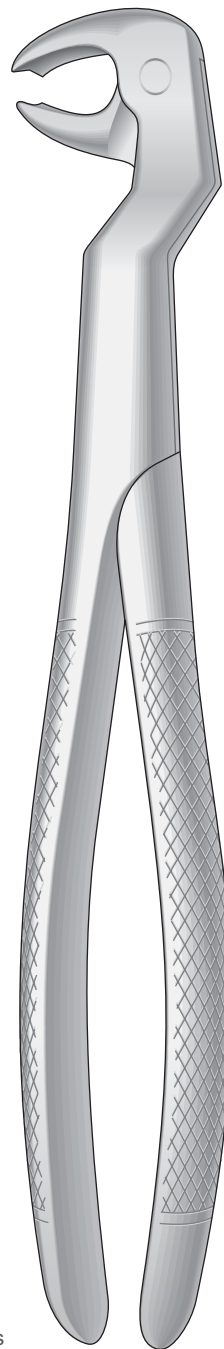

Untere Molaren und Weisheitszähne, links
Lower molars and wisdom teeth, left
Molari e denti del giudizio inferiori, a sinistra
Molares y muelas del juicio inferiores, izquierda
Molaires et dent de sagesse inférieures, gauches

**ROUTURIER
22 1/2 L**



Zahnzangen, Englische Form
Extracting Forceps, English Pattern
Pinze per estrazione, Forma Inglese
Pinzas da extracciòn, Forma Inglesa
Daviers, Forme Anglaise

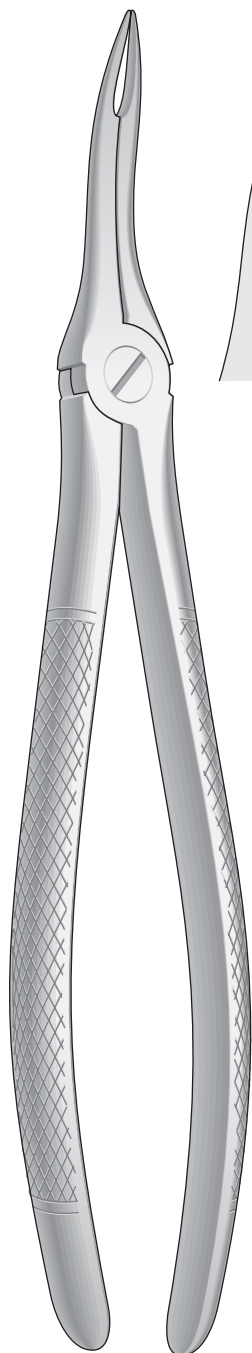

49
Fig. 49

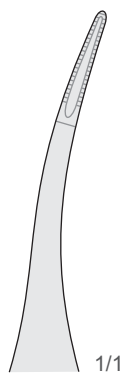

48
Fig. 48 - 44

Obere Wurzeln
Upper roots
Radici superiori
Raíces superiores
Racines supérieures

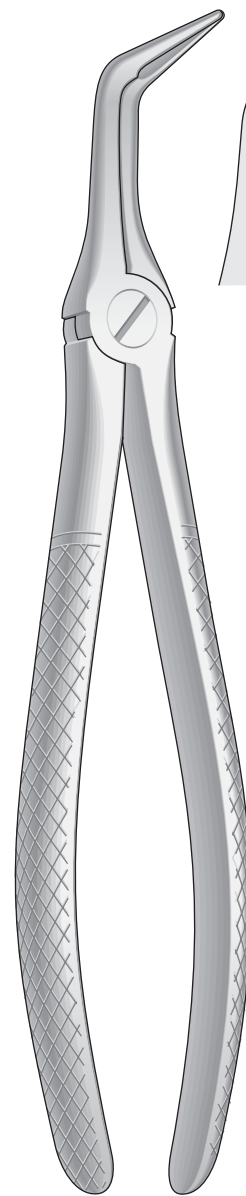
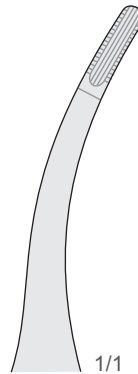

46L
Fig. 46L

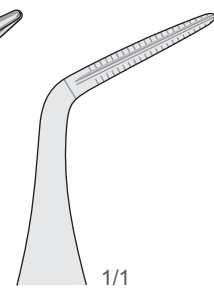

Obere Wurzeln sehr feine
Upper very fine roots
Radici superiori molto sottili
Raíces superiores muy finas
Racines supérieures très fines

Untere Wurzeln
Lower roots
Radici inferiori
Raíces inferiores
Racines inférieures



Zahnzangen mit Paßformgriff
Extracting Forceps with anatomically shaped handle
Pinze per estrazione con manico anatomico
Pinzas da extracciòn con mango adaptado a la anatomia de la mano
Daviers avec manche adapté à l'anatomie de la main

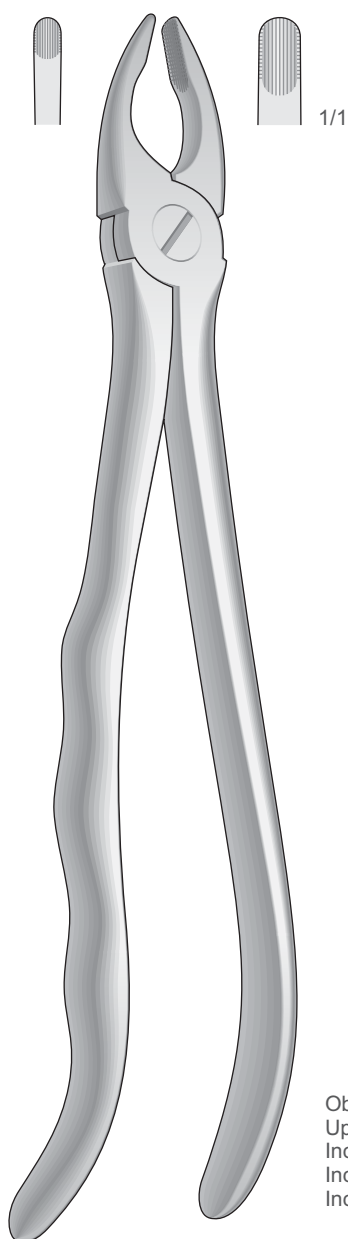

S-3AN
Fig. 3

Obere Schneide- und Eckzähne
Upper incisors and cuspids
Incisivi e canini superiori
Incisivos y caninos superiores
Incisives et canines supérieures

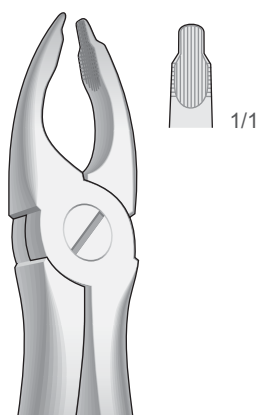

S-34
Fig. 34

Obere Schneide- und Eckzähne
Upper incisors and cuspids
Incisivi e canini superiori
Incisivos y caninos superiores
Incisives et canines supérieures

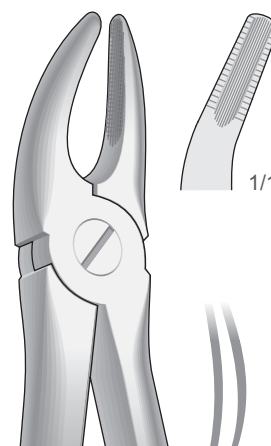

S-7
Fig. 7

Obere Prämolaren
Upper premolars
Premolari superiori
Premolares superiores
Prémolaires supérieures

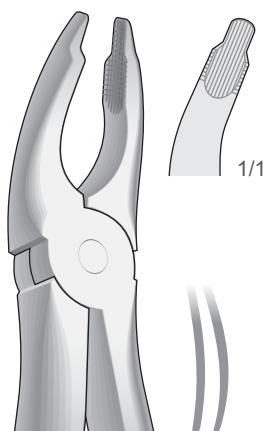

S-35
Fig. 35

Obere Schneidezähne und Prämolaren, tiefgreifend
Upper incisors and bicuspid, deep-gripping
Incisivi e premolari superiori, presa in profondità
Incisivos y premolares superiores, a gran calado
Incisives et prémolaires supérieures, à attaque profonde



Zahnzangen mit Paßformgriff
Extracting Forceps with anatomically shaped handle
Pinze per estrazione con manico anatomico
Pinzas da extracciòn con mango adaptado a la anatomia de la mano
Daviers avec manche adapté à l'anatomie de la main

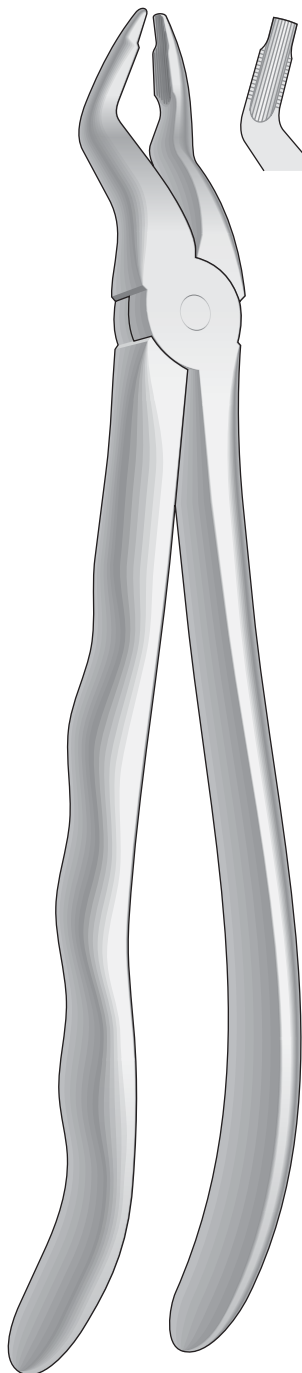

S-31
Fig. 31

Obere Prämolaren
Upper premolars
Premolari superiori
Premolares superiores
Prémolaires supérieures

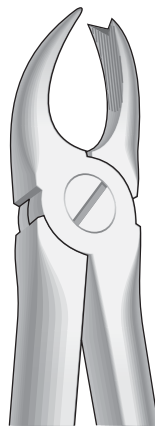
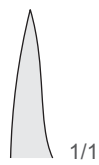
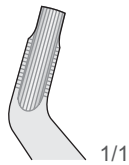

S-66R
Fig. 66R (89)

Obere Molaren, rechts
Upper molars, right
Molari superiori, destra
Molares superiores, derechos
Molaires supérieures, droites

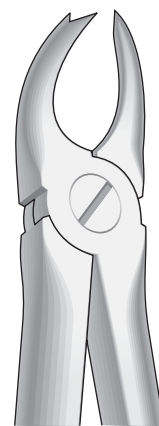
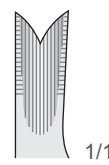
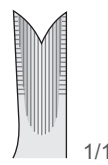

S-66L
Fig. 66L (90)

Obere Molaren, links
Upper molars, left
Molari superiori, sinistra
Molares superiores, izquierdos
Molaires supérieures, gauches



Zahnzangen mit Paßformgriff
Extracting Forceps with anatomically shaped handle
Pinze per estrazione con manico anatomico
Pinzas da extracciòn con mango adaptado a la anatomia de la mano
Daviers avec manche adapté à l'anatomie de la main

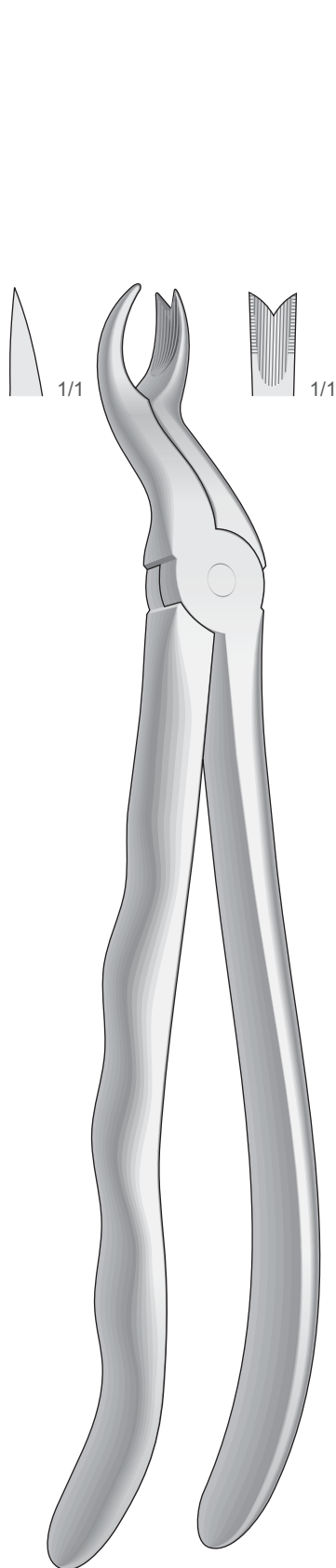

S-67R
Fig. 67R

Obere Molaren, rechts
Upper molars, right
Molari superiori, destra
Molares superiores, derechos
Molaires supérieures, droites

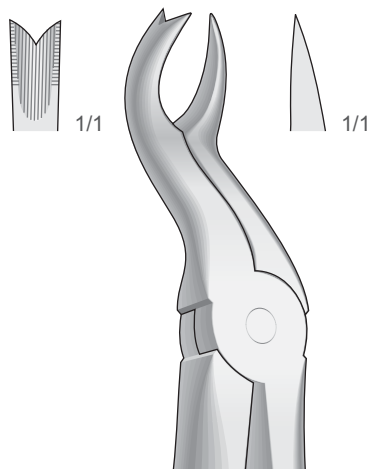

S-67L
Fig. 67L

Obere Molaren, links
Upper molars, left
Molari superiori, sinistra
Molares superiores, izquierdos
Molaires supérieures, gauches

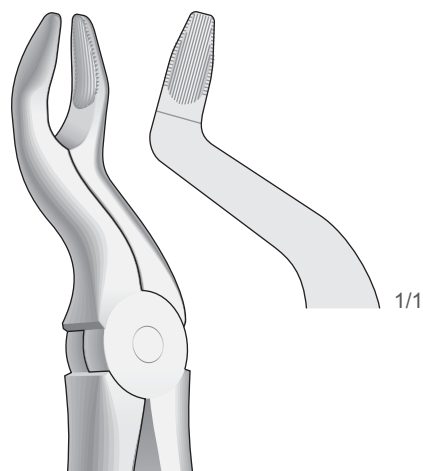

S-67N
Fig. 67N

Obere Molaren
Upper molars
Molari superiori
Molares superiores
Molaires supérieures



Zahnzangen mit Paßformgriff
Extracting Forceps with anatomically shaped handle
Pinze per estrazione con manico anatomico
Pinzas da extracciòn con mango adaptado a la anatomia de la mano
Daviers avec manche adapté à l'anatomie de la main

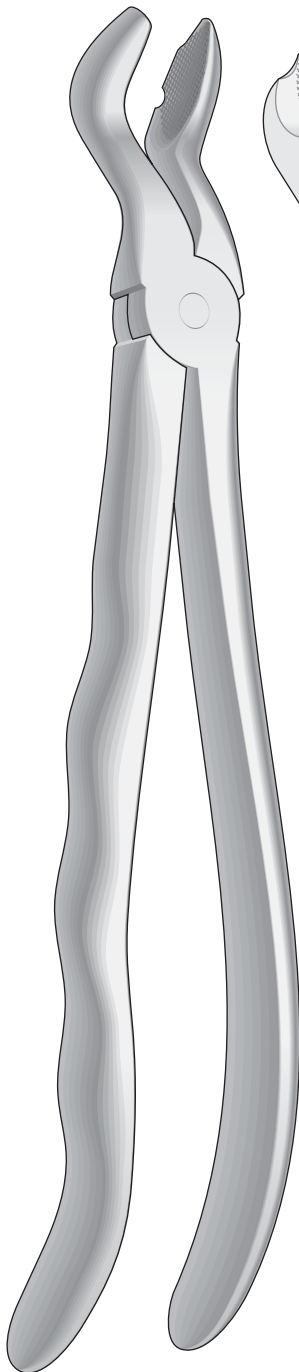

FELSCH
S-80
Fig. 80

Für obere Weisheitszähne, mit Fangvorrichtung
For upper wisdom teeth, with retaining device
Denti del giudizio superiori, con dispositivo di presa
Muelas del juicio superiores, con dispositivo de retencion
Pour dents de sagesse supérieures, mors conçus pour recueillir la dent

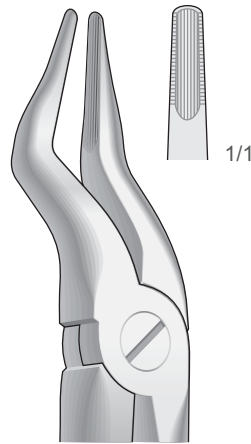

S-51B
Fig. 51B

Obere Dritte Molaren
Upper molars
Ottavi superiori
Molares superiores
Molaires supérieures

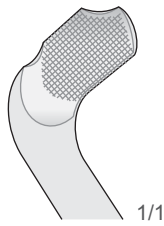

1/1

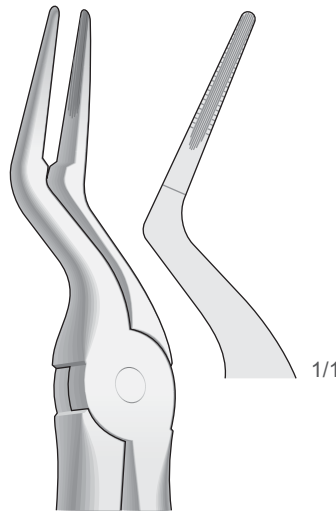

S-97
Fig. 97

Obere Wurzelplitterzange
Upper Root Fragments
Frammenti e radici superiori
Fragmentos de raices superiores
Fragments des racines supérieures

1/1

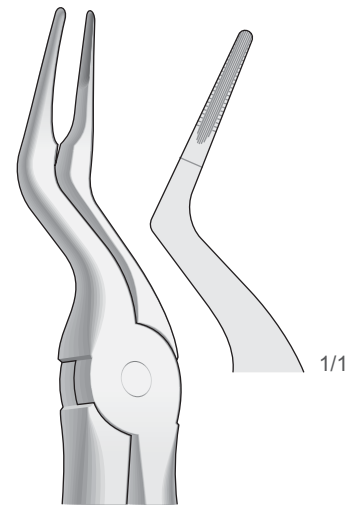

S-97B
Fig. 97B

Obere Wurzelplitterzange
Upper Root Fragments
Frammenti e radici superiori
Fragmentos de raices superiores
Fragments des racines supérieures

1/1



Zahnzangen mit Paßformgriff
 Extracting Forceps with anatomically shaped handle
 Pinze per estrazione con manico anatomico
 Pinzas da extracciòn con mango adaptado a la anatomia de la mano
 Daviers avec manche adapté à l'anatomie de la main

Obere Wurzeln sehr feine
 Upper very fine roots
 Radici superiori molto sottili
 Raíces superiores muy finas
 Racines supérieures très fines

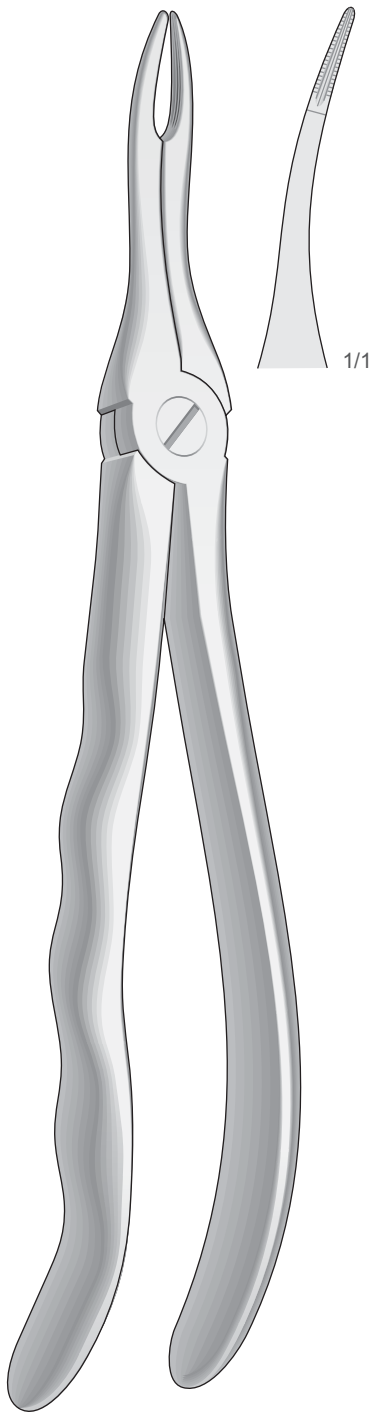

S-49
Fig. 49

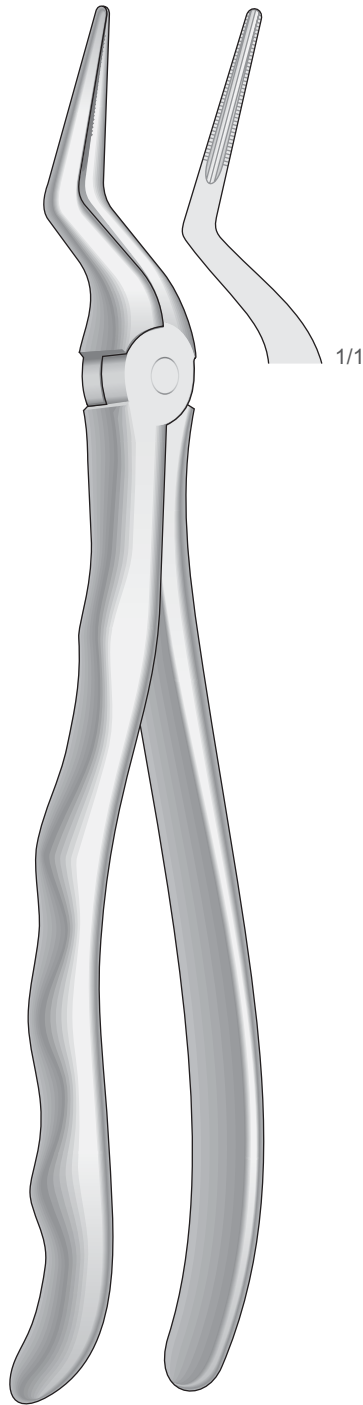

S-51LX
Fig. 51LX

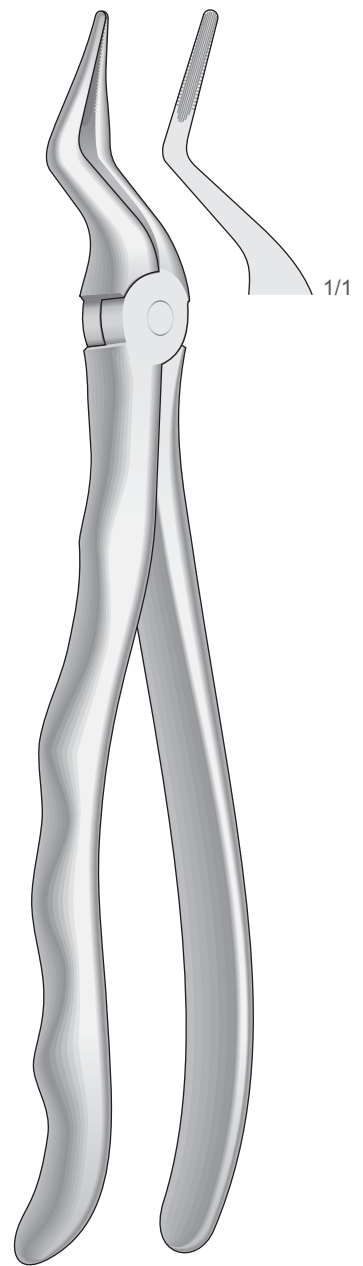

S-351S
Fig. 351S



Zahnzangen mit Paßformgriff
Extracting Forceps with anatomically shaped handle
Pinze per estrazione con manico anatomico
Pinzas da extracciòn con mango adaptado a la anatomia de la mano
Daviers avec manche adapté à l'anatomie de la main

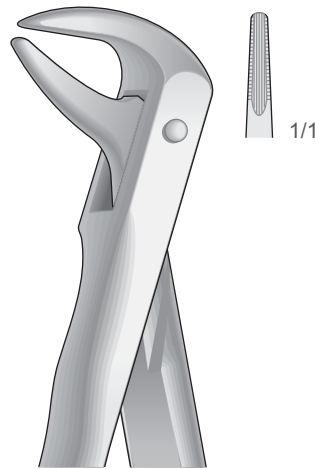

I-74N
Fig. 74N

Untere Wurzeln Schneide- und Eckzähne
Lower roots, incisors and cuspids
Radici, incisivi e canini inferiori
Raíces, incisivos y caninos inferiores
Racines, incisives et canines inférieures

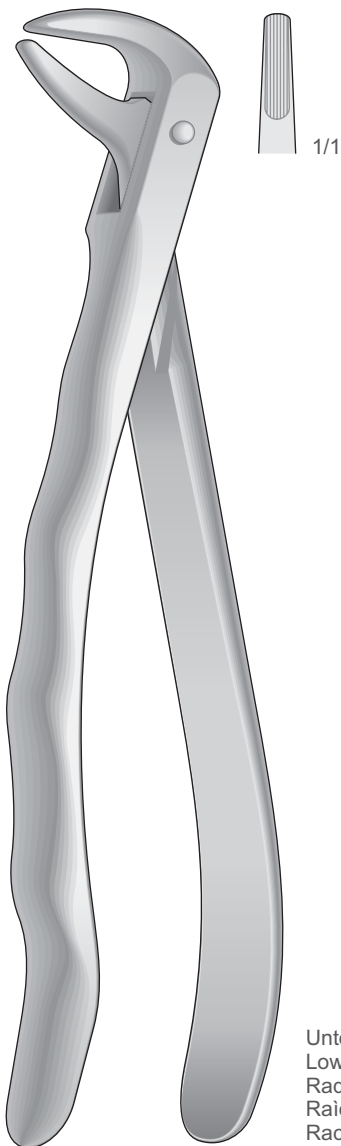

I-74
Fig. 74

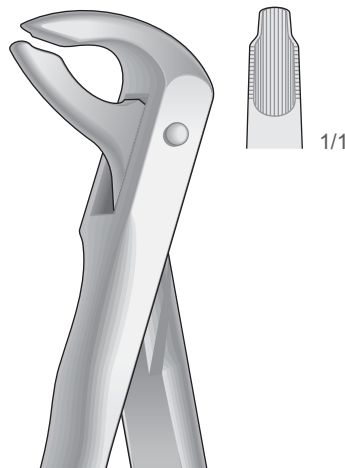

I-36
Fig. 36

Untere Wurzeln Schneide- und Eckzähne
Lower roots, incisors and cuspids
Radici, incisivi e canini inferiori
Raíces, incisivos y caninos inferiores
Racines, incisives et canines inférieures

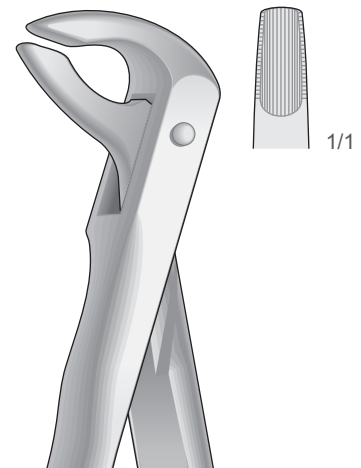

I-36N
Fig. 36N

Untere Wurzeln Schneide- und Eckzähne
Lower roots, incisors and cuspids
Radici, incisivi e canini inferiori
Raíces, incisivos y caninos inferiores
Racines, incisives et canines inférieures



Zahnzangen mit Paßformgriff
Extracting Forceps with anatomically shaped handle
Pinze per estrazione con manico anatomico
Pinzas da extracciòn con mango adaptado a la anatomia de la mano
Daviers avec manche adapté à l'anatomie de la main

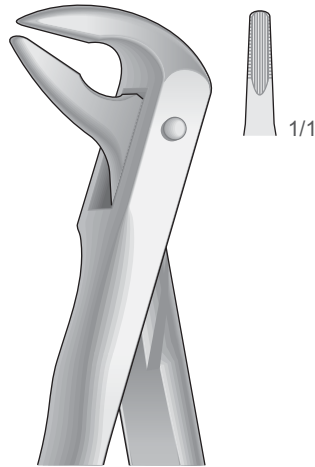

I-59
Fig. 59

Untere Wurzelplitterzange
Lower Root Fragments
Frammenti e radici inferiori
Fragmentos de raices inferiores
Fragments des racines inférieures

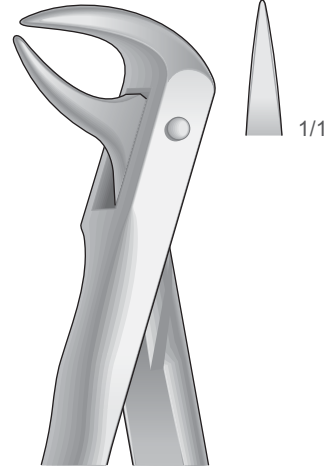

I-86C
Fig. 86C

Untere Molaren mit käriösen oder abgebrochenen Kronen
Lower molars with carious or broken caps
Molari inferiori con corone cariate o spezzate
Molares inferiores con coronas rotas o cariadas
Molaires inférieures avec couronnes cariées ou cassées

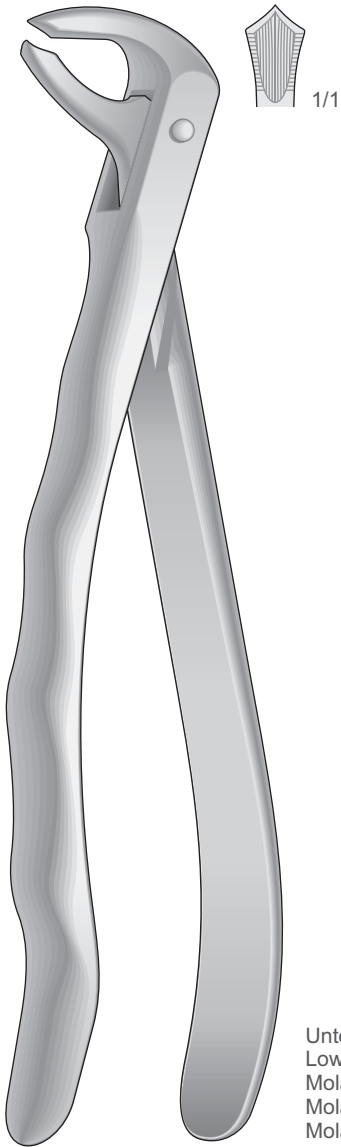

I-73
Fig. 73

Untere Molaren
Lower molars
Molari inferiori
Molares inferiores
Molaires inférieures

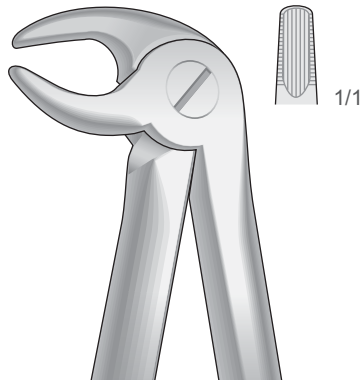

I-13
Fig. 13

Untere Prämolaren und Eckzähne
Lower premolars and cuspids
Canini e premolari inferiori
Caninos y premolares inferiores
Canines et prémolaires inférieures



I-22
Fig. 22

Untere Molaren
Lower molars
Molari inferiori
Molares inferiores
Molaires inférieures



Zahnzangen mit Paßformgriff
Extracting Forceps with anatomically shaped handle
Pinze per estrazione con manico anatomico
Pinzas da extracciòn con mango adaptado a la anatomia de la mano
Daviers avec manche adapté à l'anatomie de la main

Untere Weisheitszähne
Lower wisdom teeth
Denti del giudizio inferiori
Muelas del juicio inferiores
Dent de sagesse inférieures

Untere Prämolaren
Lower premolars
Premolari inferiori
Premolares inferiores
Prémolaires inférieures

Untere Molaren
Lower Molars
Molari inferiori
Molares inferiores
Molaires inférieures

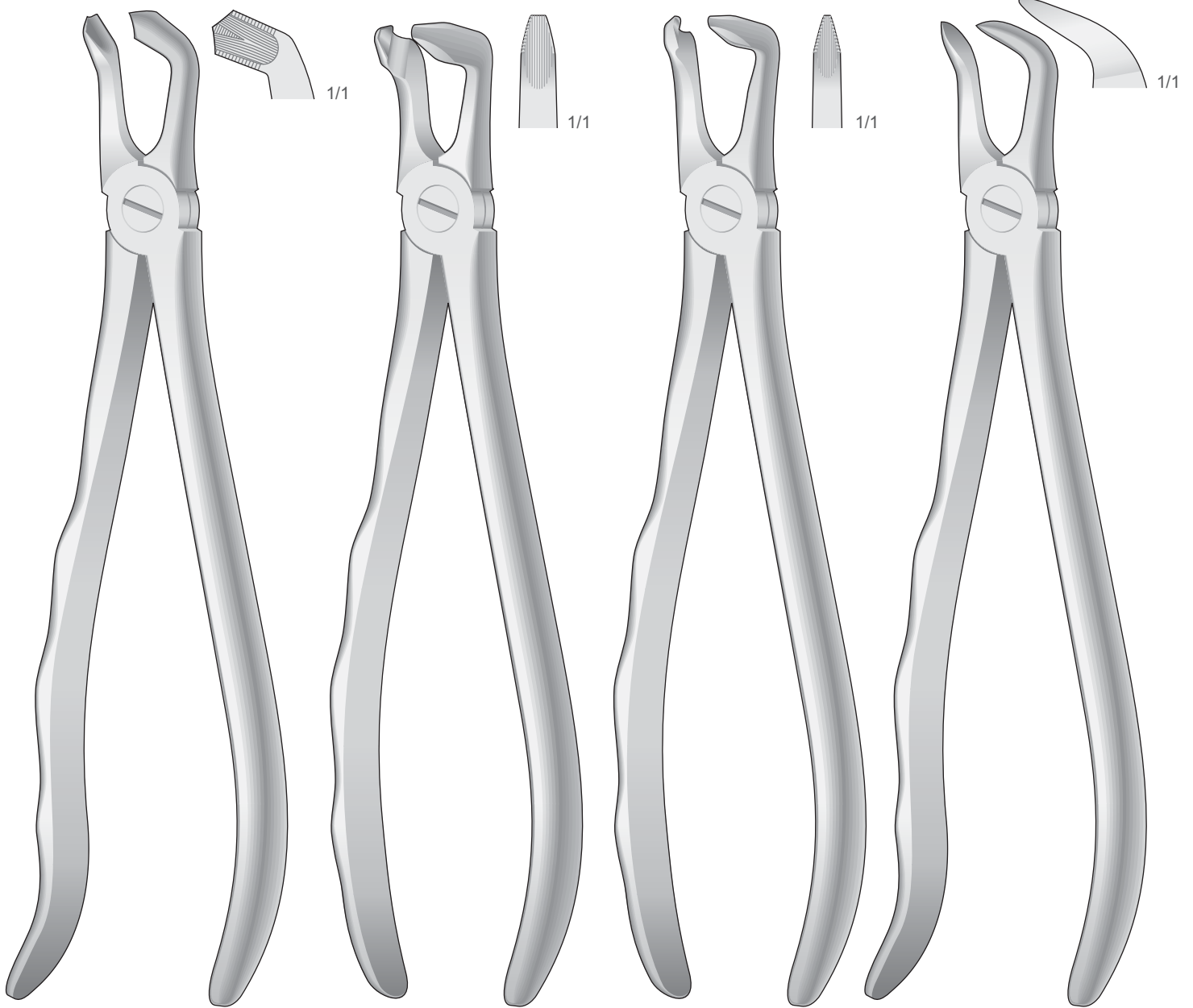

I-79
Fig. 79

I-79N
Fig. 79N

I-46N
Fig. 46N

I-87
Fig. 87



Zahnzangen mit Paßformgriff
Extracting Forceps with anatomically shaped handle
Pinze per estrazione con manico anatomico
Pinzas da extracciòn con mango adaptado a la anatomia de la mano
Daviers avec manche adapté à l'anatomie de la main



Untere Wurzeln
Lower roots
Radici inferiori
Raíces inferiores
Racines inférieures

I-46LX
Fig. 46LX



Untere Wurzeln
Lower roots
Radici inferiori
Raíces inferiores
Racines inférieures

I-46L
Fig. 46L



Zahnzangen mit Paßformgriff
 Extracting Forceps with anatomically shaped handle
 Pinze per estrazione con manico anatomico
 Pinzas da extracciòn con mango adaptado a la anatomia de la mano
 Daviers avec manche adapté à l'anatomie de la main

Untere Molaren und Weisheitszähne
 Lower molars and wisdom teeth
 Molari e denti del giudizio inferiori
 Molares y muelas del juicio inferiores
 Molaires et dent de sagesse inférieures

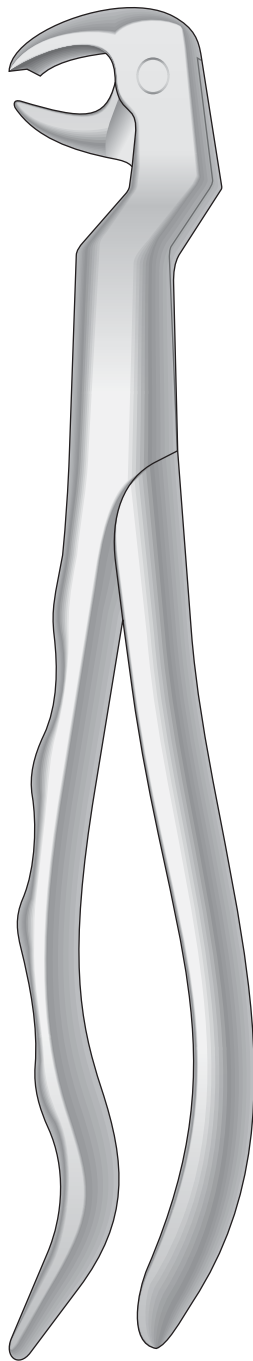

I-22 1/2 L

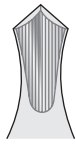

1/1

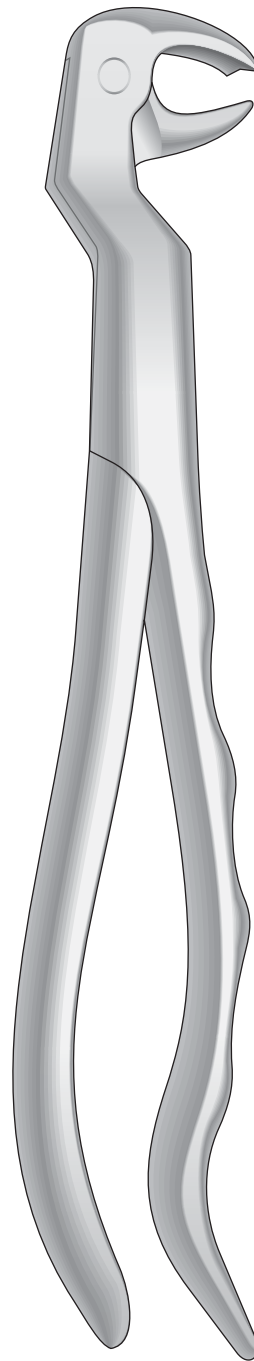

I-22 1/2 R

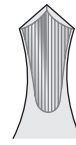

1/1

Links
 Left
 Sinistra
 Izquierdos
 Gauches

Rechts
 Right
 Destra
 Derechos
 Droites



Zahnzangen mit Paßformgriff
Extracting Forceps with anatomically shaped handle
Pinze per estrazione con manico anatomico
Pinzas da extracciòn con mango adaptado a la anatomia de la mano
Daviers avec manche adapté à l'anatomie de la main

Untere Wurzeln sehr feine
Lower very fine roots
Radici inferiori molto sottili
Raices inferiores muy finas
Racines inférieures très fines

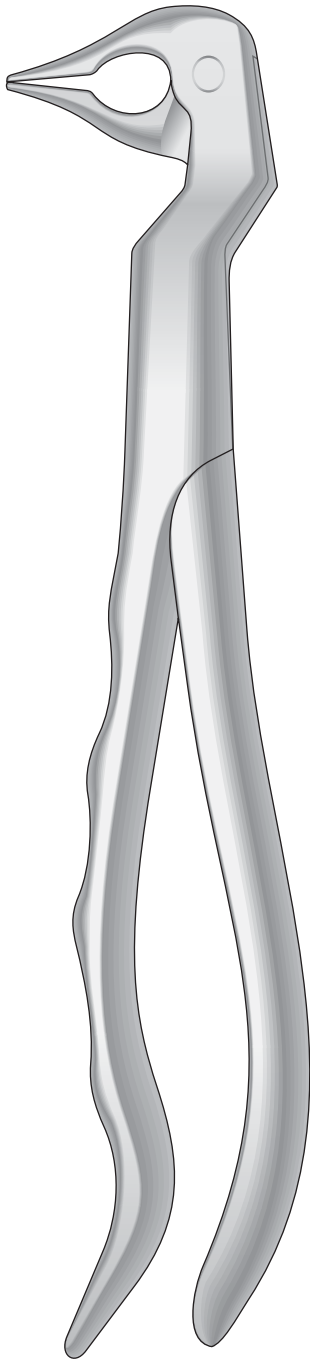

Links
Left
Sinistra
Izquierdos
Gauches

I-133 L
Fig.133

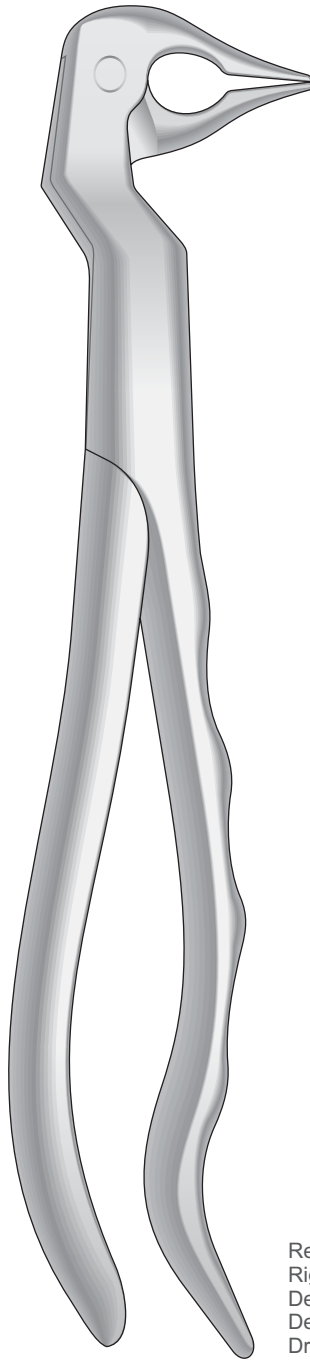

Rechts
Right
Destra
Derechos
Droites

I-133 R
Fig.133

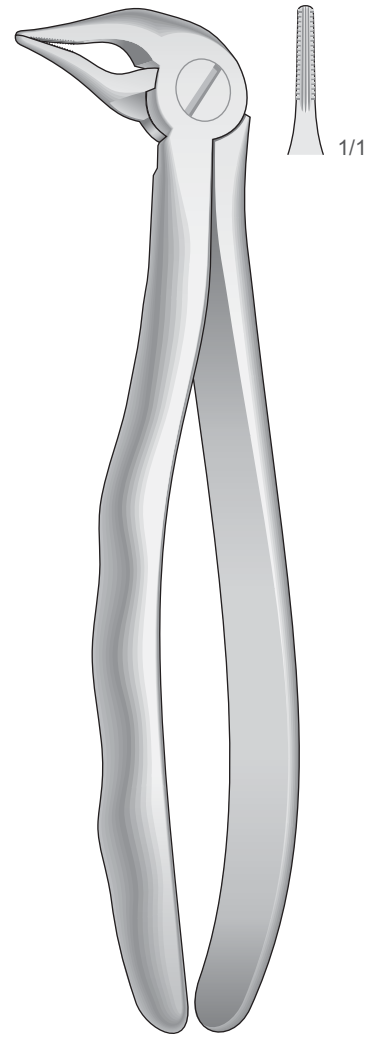

I-333S
Fig.333S



Zahnzangen, Amerikanische Form
Extracting Forceps, American Pattern
Pinze per estrazione, Forma Americana
Pinzas da extracciòn, Forma Americana
Daviers, Forme Américaine

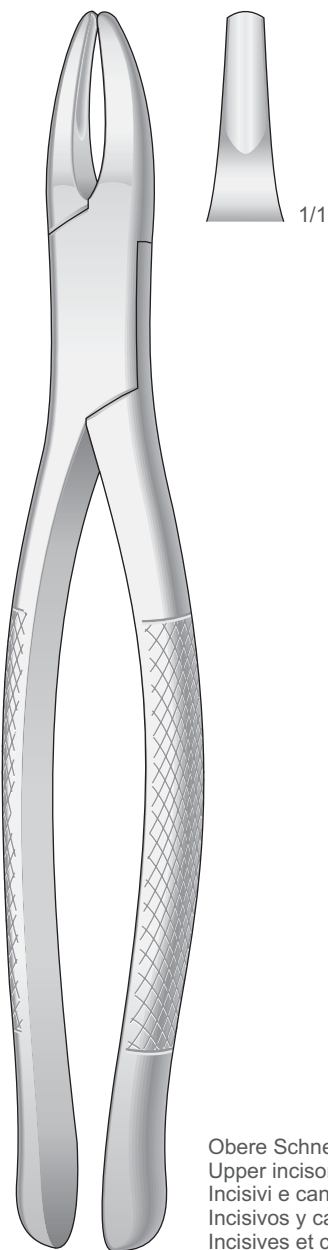

AM-1
Fig. 1

Obere Schneide- und Eckzähne
Upper incisors and cuspids
Incisivi e canini superiori
Incisivos y caninos superiores
Incisives et canines supérieures

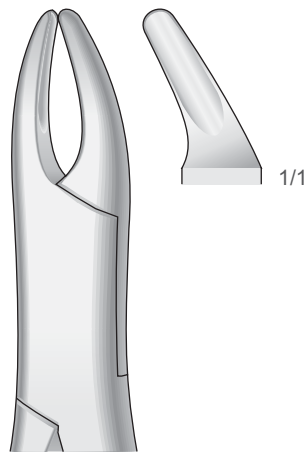

CRYER
AM-150
Fig. 150

Obere Prämolaren, Schneidezähne, Wurzeln
Upper Bicuspid, incisors and roots
Premolari, incisivi e radici superiori
Premolares, incisivos y raíces superiores
Prémolaires, incisives et racines supérieures

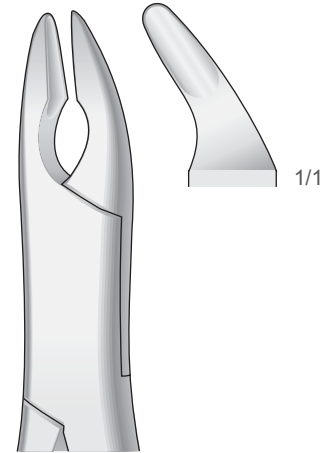

CRYER
AM-150A
Fig. 150A

Obere Prämolaren, Schneidezähne, Wurzeln
Upper Bicuspid, incisors and roots
Premolari, incisivi e radici superiori
Premolares, incisivos y raíces superiores
Prémolaires, incisives et racines supérieures

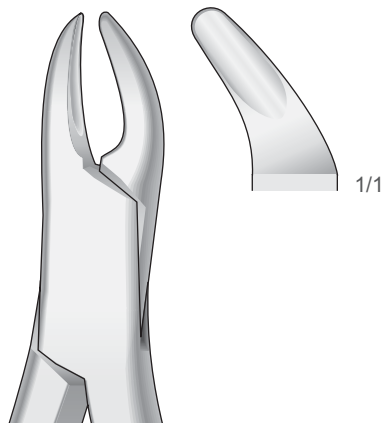

AM-62
Fig. 62

Schneidezähne, Prämolaren, Milchzähne
Incisors, premolars, deciduous teeth
Incisivi, premolari, denti da latte
Incisivos, premolares, dientes de leche
Incisives, prémolaires, dents de lait



Zahnzangen, Amerikanische Form
Extracting Forceps, American Pattern
Pinze per estrazione, Forma Americana
Pinzas da extracciòn, Forma Americana
Daviers, Forme Américaine

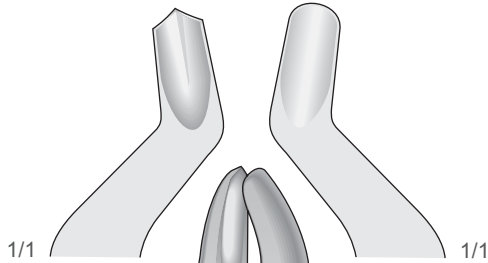

AM-53R
Fig. 53R

Obere Molaren, Rechts
Upper Molars, Right
Molari superiori, Destra
Molares superiores, Derechos
Molaires supérieures, Droites

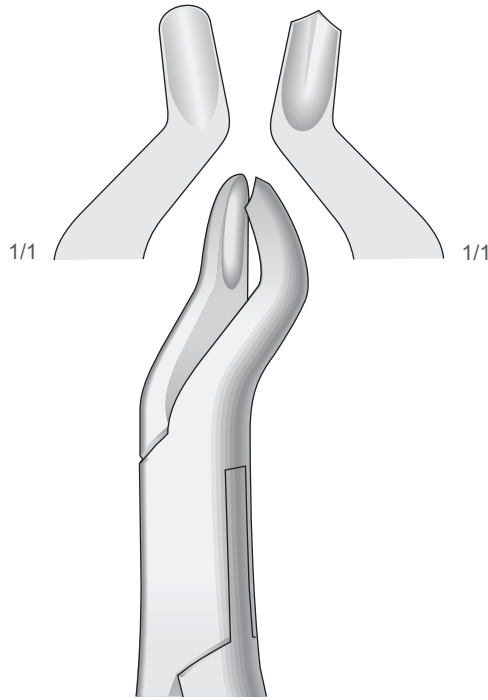

AM-53L
Fig. 53L

Obere Molaren, Links
Upper Molars, Left
Molari superiori, Sinistra
Molares superiores, Izquierdos
Molaires supérieures, Gauches

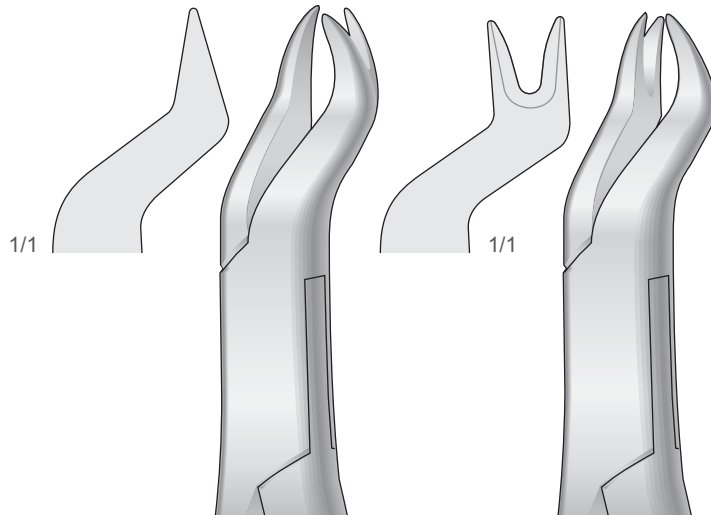

NEVIUS
AM-88R
Fig. 88R

Obere Molaren, Rechts
Upper Molars, Right
Molari superiori, Destra
Molares superiores, Derechos
Molaires supérieures, Droites

NEVIUS
AM-88L
Fig. 88L

Obere Molaren, Links
Upper Molars, Left
Molari superiori, Sinistra
Molares superiores, Izquierdos
Molaires supérieures, Gauches



Zahnzangen, Amerikanische Form
 Extracting Forceps, American Pattern
 Pinze per estrazione, Forma Americana
 Pinzas da extracciòn, Forma Americana
 Daviers, Forme Américaine

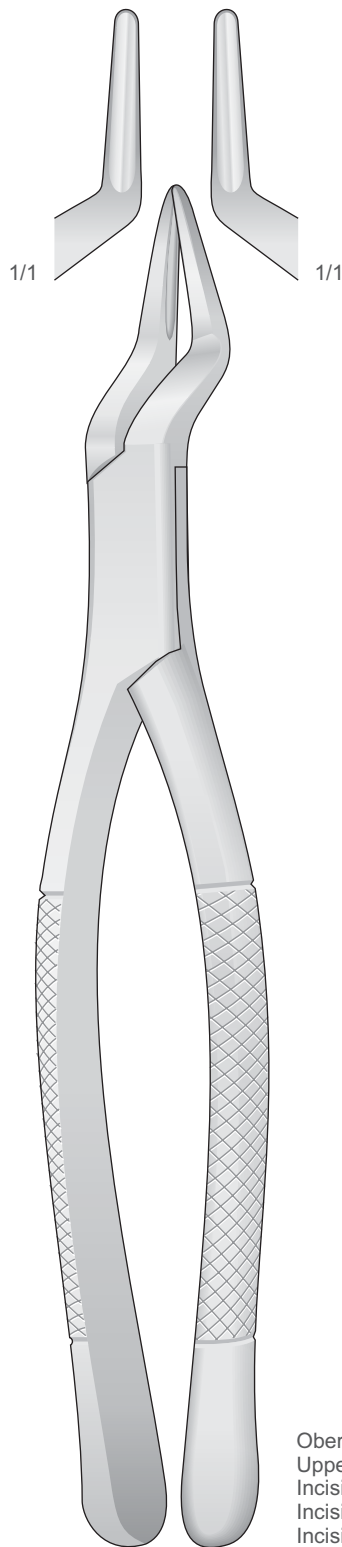

AM-65
 Fig.65

Obere Schneidezähne und Wurzeln
 Upper Incisors and Roots
 Incisivi e radici superiori
 Incisivos y raíces superiores
 Incisives et racines supérieures

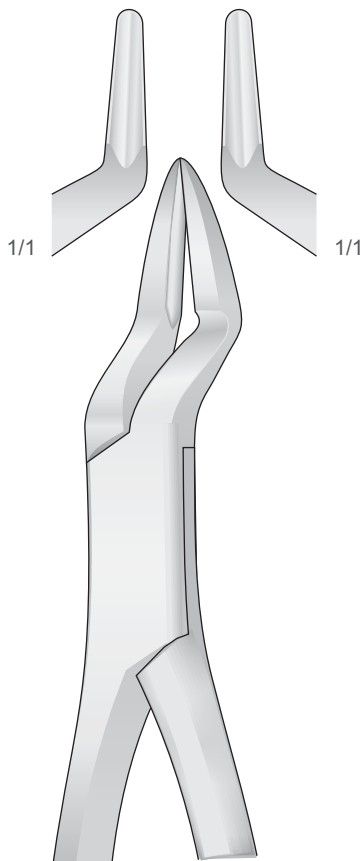

PARMLY
AM-32A
 Fig. 32A

Obere Wurzeln und Prämolaren
 Upper Roots and Premolars
 Radici e premolari superiori
 Raíces y premolares superiores
 Racines et prémolaires supérieures

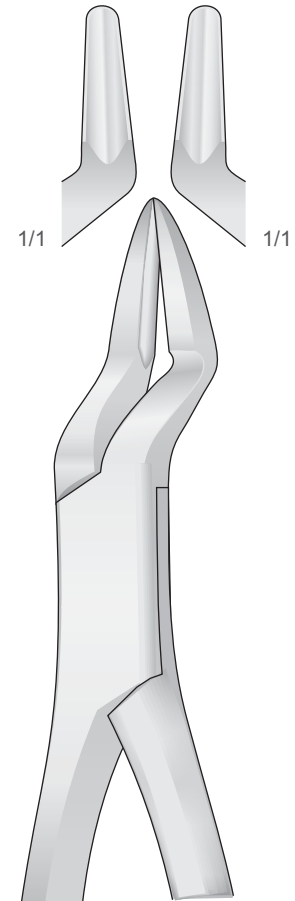

PARMLY
AM-32
 Fig. 32

Obere Prämolaren und Molaren
 Upper Premolars and Molars
 Premolari e molari superiori
 Premolares y Molares superiores
 Prémolaires et Molaires supérieures



Zahnzangen, Amerikanische Form
Extracting Forceps, American Pattern
Pinze per estrazione, Forma Americana
Pinzas da extracciòn, Forma Americana
Daviers, Forme Américaine

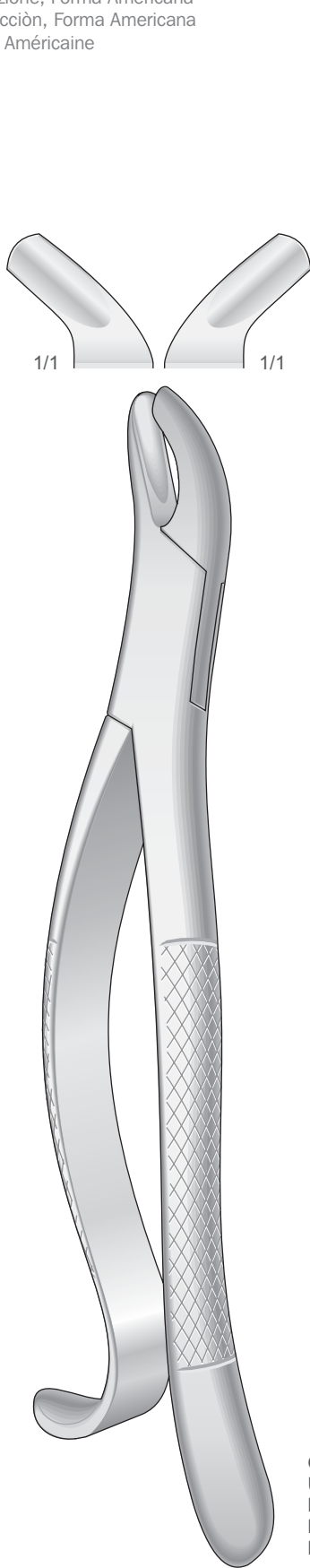

AM-24
Fig. 24

Obere Molaren
Upper Molars
Molari superiori
Molares superiores
Molaires supérieures

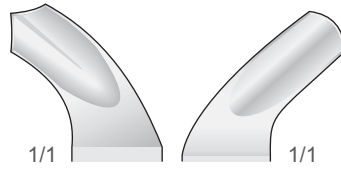

HARRIS
AM-18R
Fig. 18R

Obere Molaren, Rechts
Upper Molars, Right
Molari superiori, Destra
Molares superiores, Derechos
Molaires supérieures, Droites

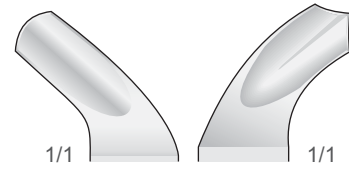

HARRIS
AM-18L
Fig. 18L

Obere Molaren, Links
Upper Molars, Left
Molari superiori, Sinistra
Molares superiores, Isquierdos
Molaires supérieures, Gauches

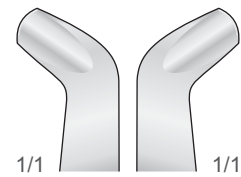

AM-210
Fig. 210

Obere Molaren
Upper Molars
Molari superiori
Molares superiores
Molaires supérieures

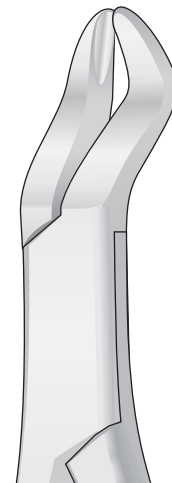



Zahnzangen, Amerikanische Form
Extracting Forceps, American Pattern
Pinze per estrazione, Forma Americana
Pinzas da extracciòn, Forma Americana
Daviers, Forme Américaine

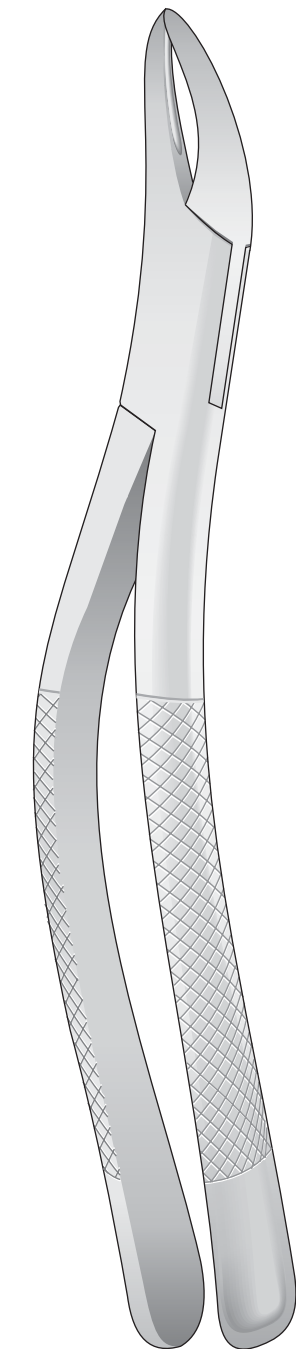
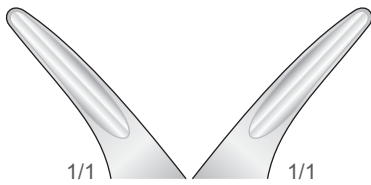

TOMES
AM-69
Fig.69

Obere und Untere
Upper and lower
Superiori e inferiori
Superiores y inferiores
Supérieures et inférieures

Wurzeln
Roots
Radici
Raíces
Racines

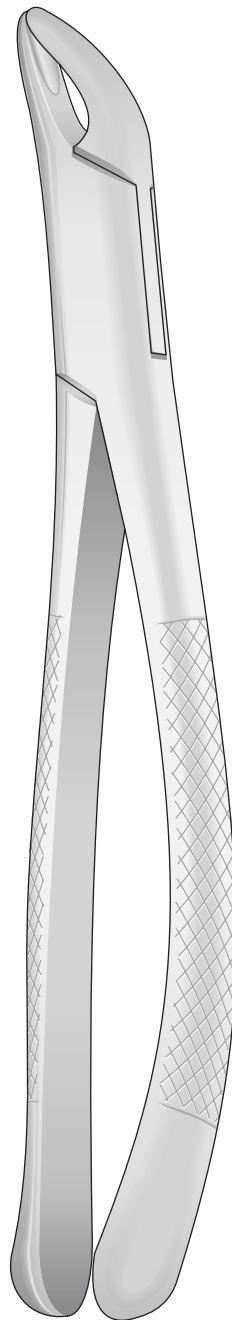
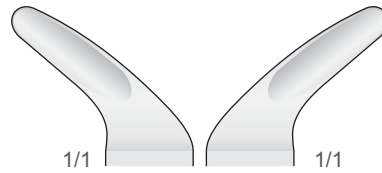

CRYER
AM-151
Fig.151

Untere
Lower
Inferiori
Inferiores
Inférieures

Schneidezähne, Prämolaren, Wurzeln
Incisors, Premolars, Roots
Incisivi, premolari, radici
Incisivos, premolares, raíces
Incisives, prémolaires, racines



HULL
AM-101
Fig. 101

Für Eckzähne und Prämolaren,
Universalzange und Kinderzange
For canines and Premolars,
Universal and Tooth forceps for children
Canini e premolari,
universale e per bambini
Caninos y premolares,
universal y para niños
Canines et prémolaires,
universel et pour enfants



Zahnzangen, Amerikanische Form
Extracting Forceps, American Pattern
Pinze per estrazione, Forma Americana
Pinzas da extracciòn, Forma Americana
Daviers, Forme Américaine

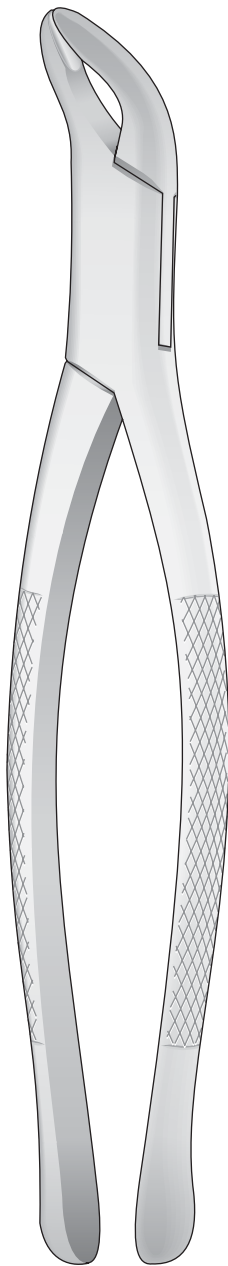
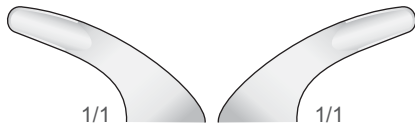

AM-203
Fig. 203

Untere Schneidezähne, Prämolaren, Wurzeln
Lower Incisors, Premolars, Roots
Incisivi, premolari, radici inferiori
Incisivos, premolares, raices inferiores
Incisives, prémolaires, racines inférieures

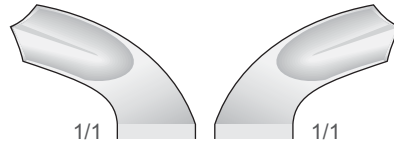

AM-17
Fig. 17

Untere Molaren
Lower Molars
Molari inferiori
Molares inferiores
Molaires inférieures

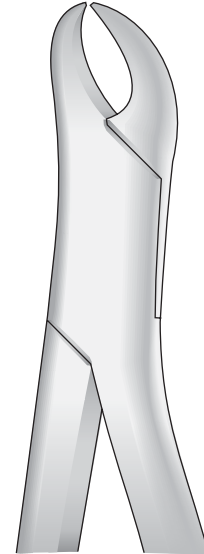
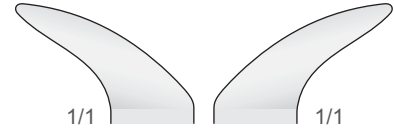

AM-23
Fig. 23

Untere Molaren
Lower Molars
Molari inferiori
Molares inferiores
Molaires inférieures



Zahnzangen, Amerikanische Form
Extracting Forceps, American Pattern
Pinze per estrazione, Forma Americana
Pinzas da extracciòn, Forma Americana
Daviers, Forme Américaine

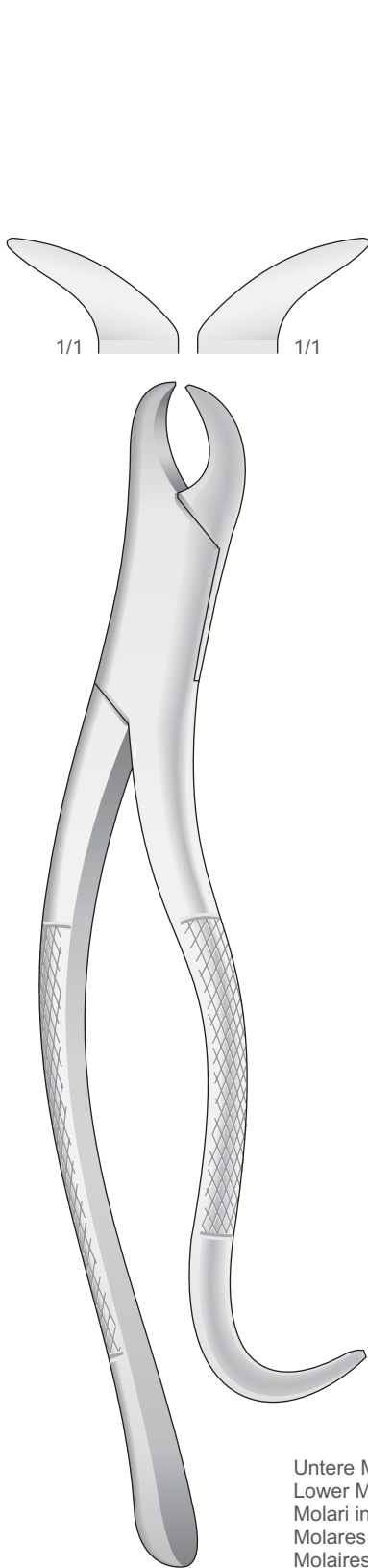

AM-16
Fig. 16

Untere Molaren
Lower Molars
Molari inferiori
Molares inferiores
Molaires inférieures

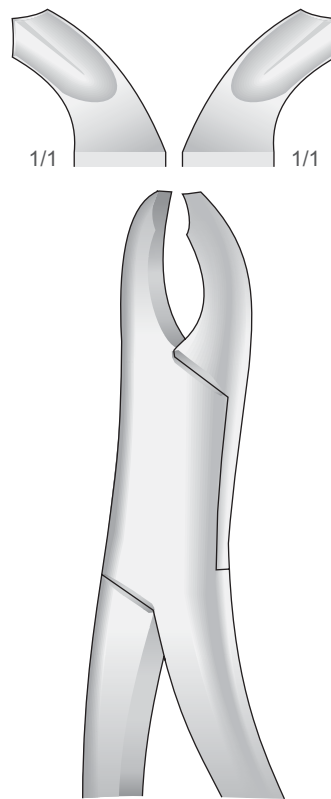

HARRIS
AM-15
Fig. 15

Untere Molaren
Lower Molars
Molari inferiori
Molares inferiores
Molaires inférieures

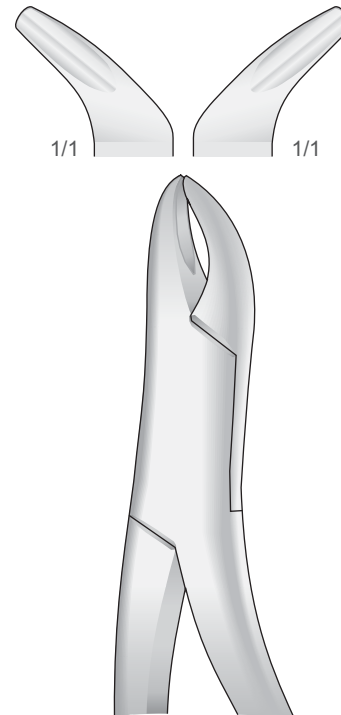

AM-103
Fig. 103

Untere Schneidezähne, Prämolaren, Wurzeln
Lower Incisors, Premolars, Roots
Incisivi, premolari, radici inferiori
Incisivos, premolares, raices inferiores
Incisives, prémolaires, racines inférieures



Zahnzangen, Amerikanische Form
Extracting Forceps, American Pattern
Pinze per estrazione, Forma Americana
Pinzas da extracciòn, Forma Americana
Daviers, Forme Américaine

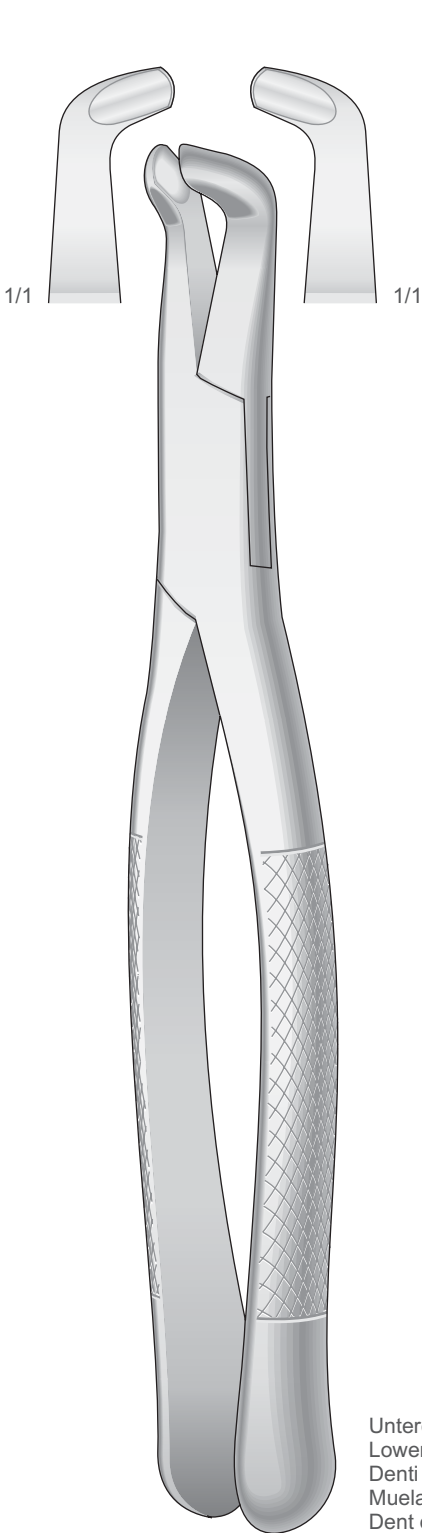

AM-222
Fig. 222

Untere Weisheitszähne
Lower wisdom teeth
Denti del giudizio inferiori
Muelas del juicio inferiores
Dent de sagesse inférieures

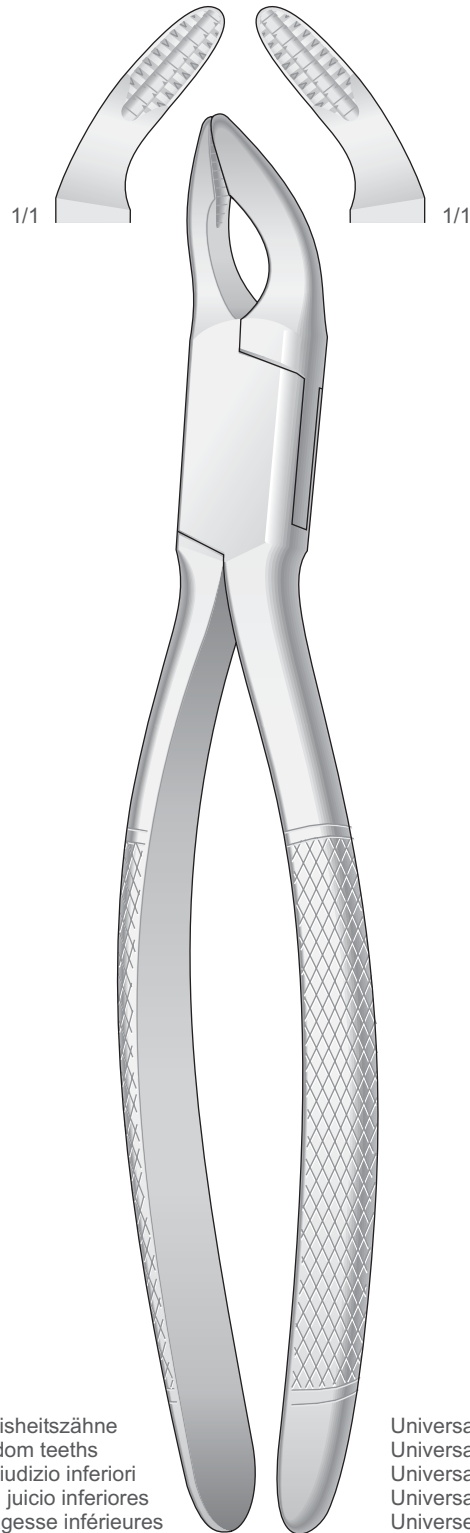

COHEN
AM-250

Universal
Universal
Universale
Universal
Universeel

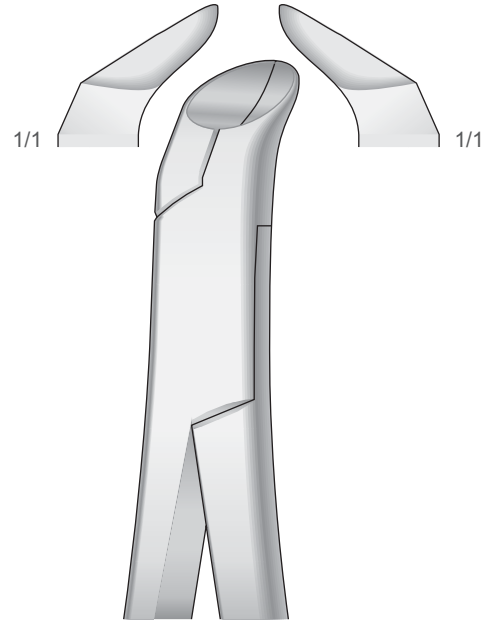

PHYSICK
AM-5
Fig. 5

Untere Weisheitszähne
Lower wisdom teeth
Denti del giudizio inferiori
Muelas del juicio inferiores
Dent de sagesse inférieures



Zahnzangen, Amerikanische Form
Extracting Forceps, American Pattern
Pinze per estrazione, Forma Americana
Pinzas da extracciòn, Forma Americana
Daviers, Forme Américaine

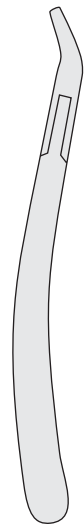
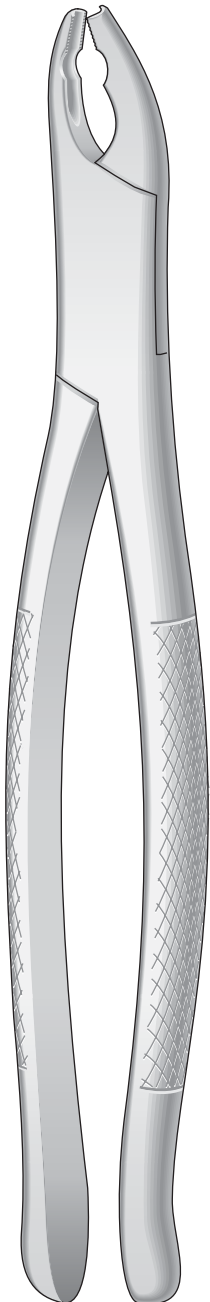
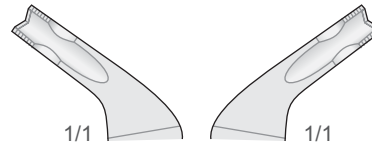
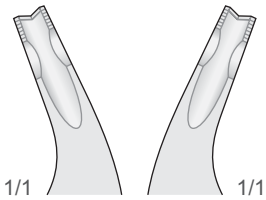

Obere
Upper
Superiori
Superiores
Supérieures

Prämolaren, Schneidezähne und Wurzeln
Bicuspid, incisors and roots
Premolari, incisivi e radici
Premolares, incisivos y raíces
Premolaires, incisives et racines

AM-150X
Fig. 150AS



Untere
Lower
Inferiori
Inferiores
Inférieures

Prämolaren, Schneidezähne und Wurzeln
Bicuspid, incisors and roots
Premolari, incisivi e radici
Premolares, incisivos y raíces
Premolaires, incisives et racines

AM-151X
Fig. 151AS



Zahnzangen, Amerikanische Form
Extracting Forceps, American Pattern
Pinze per estrazione, Forma Americana
Pinzas da extracciòn, Forma Americana
Daviers, Forme Américaine

Für Kinder
For children
Per bambini
Para niños
Pour enfants

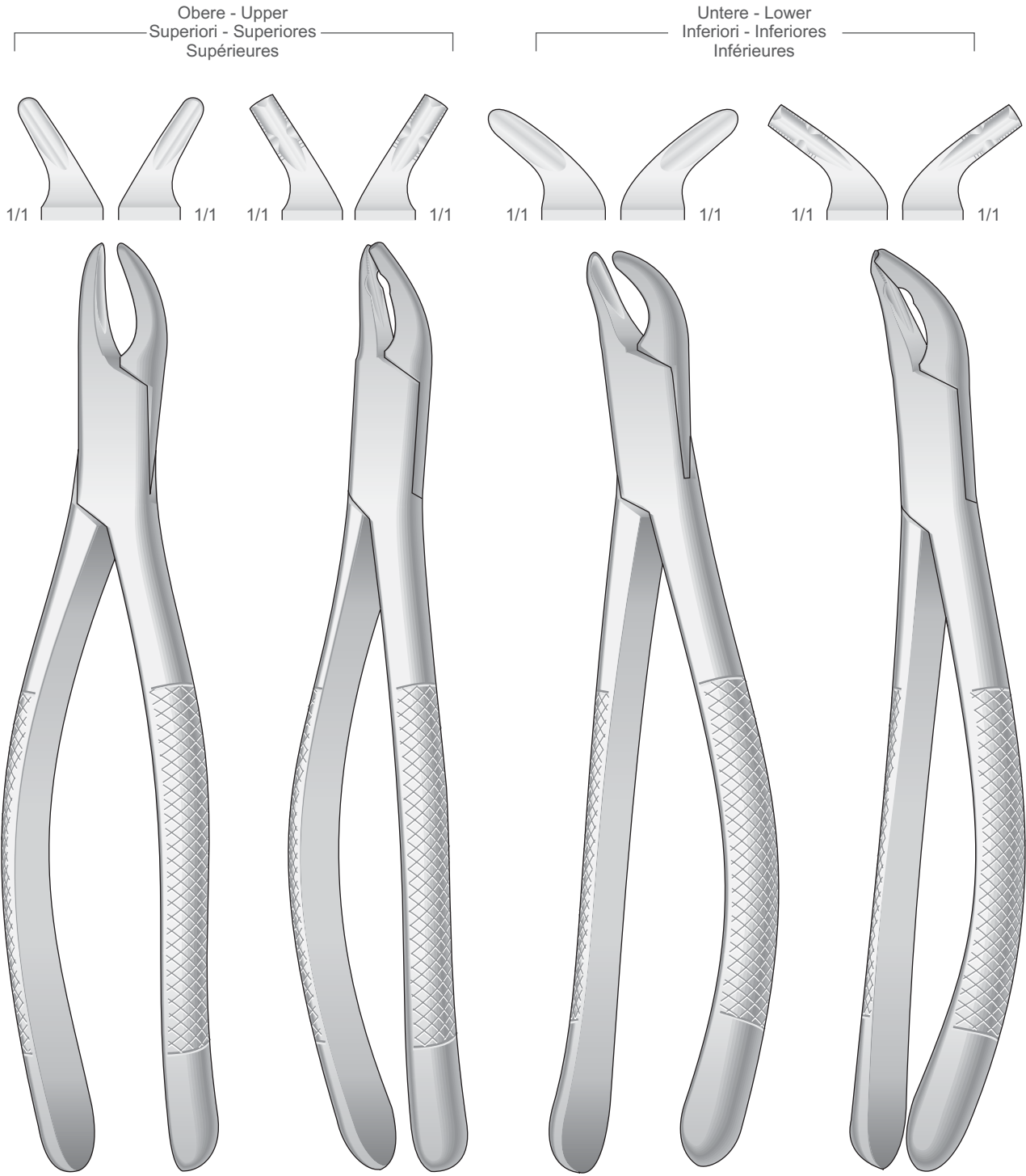

CRYER
AM-150S
Fig.150 S

AM-150AS
Fig.150 XAS

CRYER
AM-151S
Fig.151 S

AM-151AS
Fig.151 XAS



Zahnzangen, Amerikanische Form
Extracting Forceps, American Pattern
Pinze per estrazione, Forma Americana
Pinzas da extracciòn, Forma Americana
Daviers, Forme Américaine

Geriefte - Serrated - Striata - Estriadas - Striées

Obere Schneidezähne, Prämolaren, Wurzeln
Upper incisors, premolars, roots
Incisivi, premolari e radici superiori
Incisivos, premolares y raíces superiores
Incisives, premolaires et racines supérieures

Untere Schneidezähne, Prämolaren, Wurzeln
Lower incisors, premolars, roots
Incisivi, premolari e radici inferiori
Incisivos, premolares y raíces inferiores
Incisives, premolaires et racines inférieures

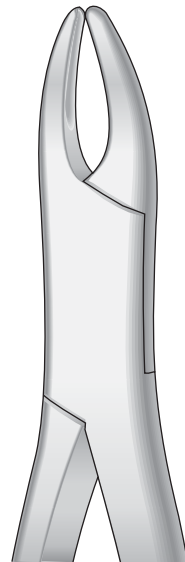
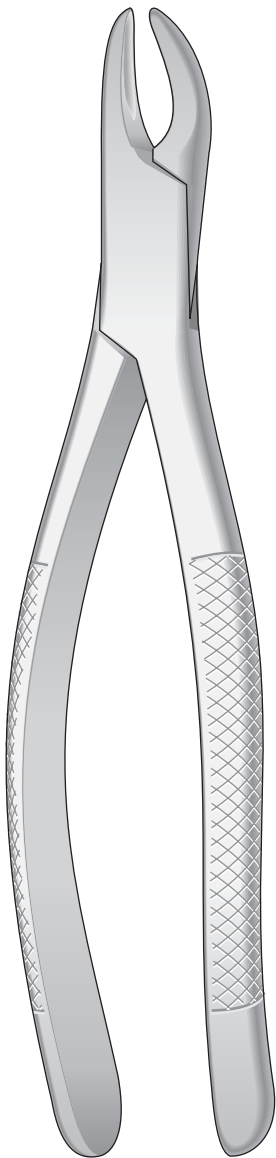
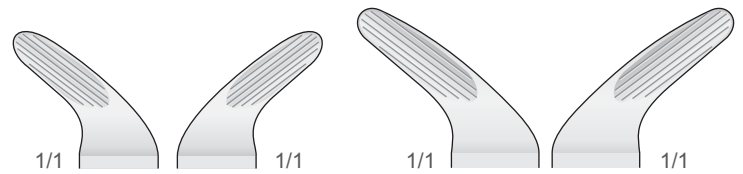
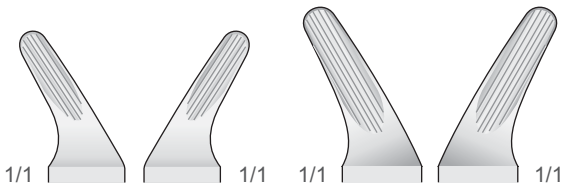

CRYER
AMG-150
Fig. 150

Für Erwachsene
For adults
Per adulti
Para adultos
Pour adults

Für Kinder
For children
Per bambini
Para niños
Pour enfants

CRYER
AMG-150S
Fig.150 S

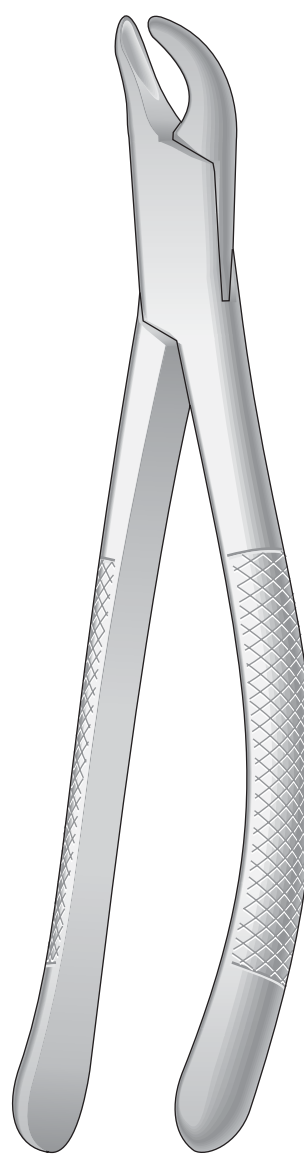

CRYER
AMG-151
Fig. 151

Für Erwachsene
For adults
Per adulti
Para adultos
Pour adults

Für Kinder
For children
Per bambini
Para niños
Pour enfants

CRYER
AMG-151S
Fig.151 S



Zahnzangen
Extracting Forceps
Pinze per estrazione
Pinzas da extracciòn
Daviers

Schneidezähne, Eckzähne, Wurzeln
Incisors, bicuspid and roots
Incisivi, canini e radici
Incisivos, caninos y raíces
Incisives, canines et racines

Molaren
Molars
Molari
Molares
Molaires

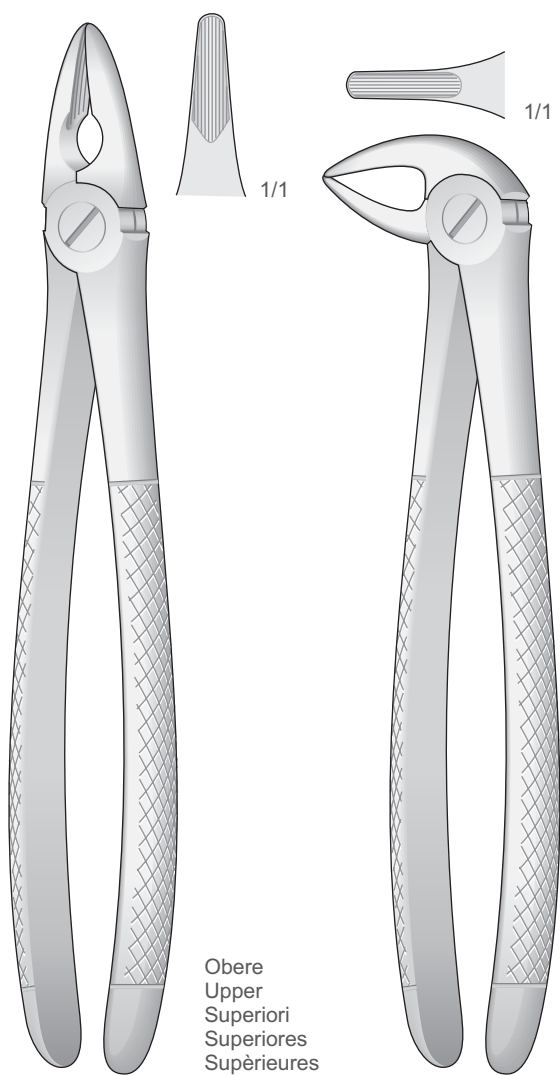

**MEAD
MD-1**

**MEAD
MD-3**

Obere
Upper
Superiori
Superiores
Supérieures

Untere
Lower
Inferiori
Inferiores
Inférieures

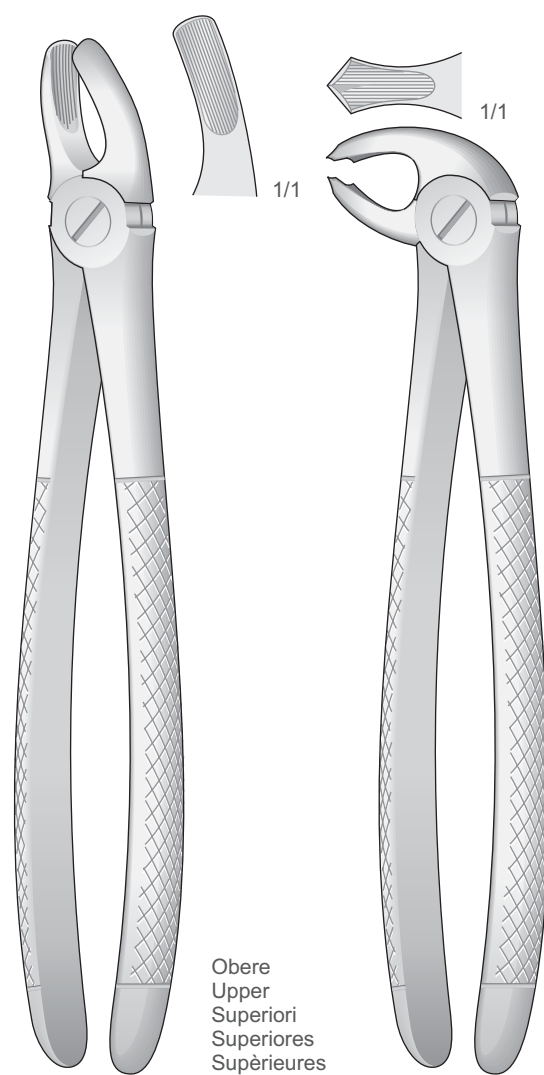

**MEAD
MD-2**

**MEAD
MD-4**

Obere
Upper
Superiori
Superiores
Supérieures

Untere
Lower
Inferiori
Inferiores
Inférieures



Kinderzahnzangen, Amerikanische Form
Extracting Forceps for children, American Pattern
Pinze per estrazione per bambini, Forma Americana
Forceps dentales para niños, Forma Americana
Daviers pour enfants, Forme Américaine

Molaren
Pedo Lower Molars
Molari
Molares
Molaires

Molaren
Pedo Lower Molars
Molari
Molares
Molaires

Zähne und wurzeln
Pedo upper incisors
Bicuspid and roots
Denti e radici
Dientes y raíces
Dentes et racines

Zähne und wurzeln
Pedo lower incisors
Bicuspid and roots
Denti e radici
Dientes y raíces
Dentes et racines

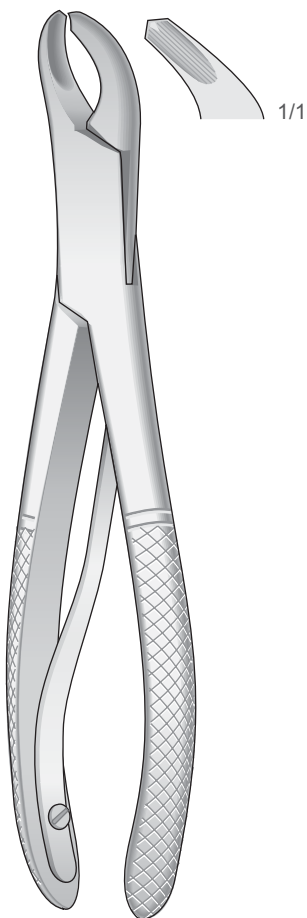

PEB-17S
Fig. 17SK

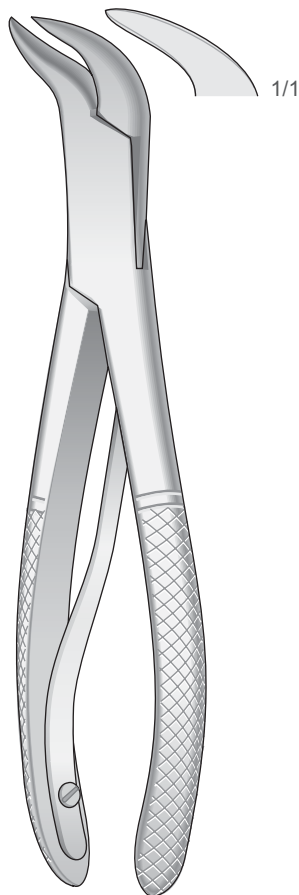

PEB-23S
Fig. 23SK

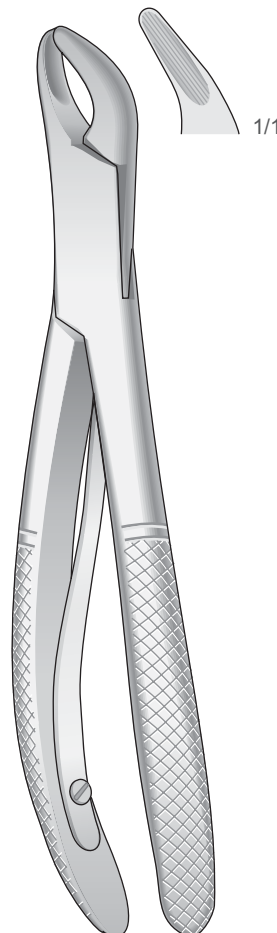

PEB-150S
Fig. 150SK

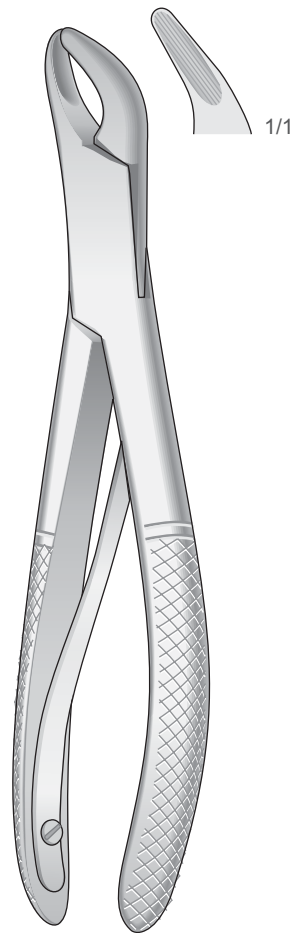

PEB-151S
Fig. 151SK



Kinderzahnzangen
Extracting Forceps for children
Pinze per estrazione per bambini
Forceps dentales para niños
Daviers pour enfants

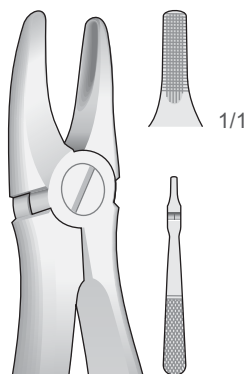

PEB-1
Fig. 137

Obere Schneidezähne
Upper Incisors
Incisivi superiori
Incisivos superiores
Incisives supérieures

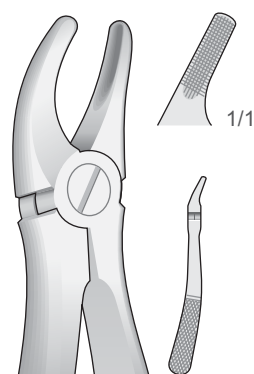

PEB-2
Fig. 139

Obere Prämolaren
Upper Premolars
Premolari superiori
Premolares superiores
Prémolaires supérieures

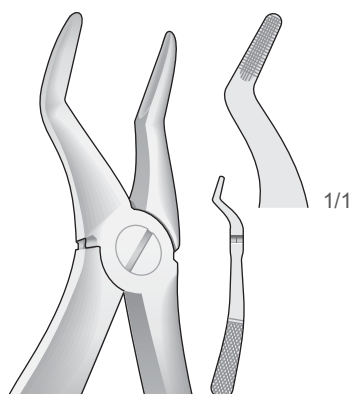

PEB-4
Fig. 51S

Obere Wurzeln
Upper roots
Radici superiori
Raíces superiores
Racines supérieures

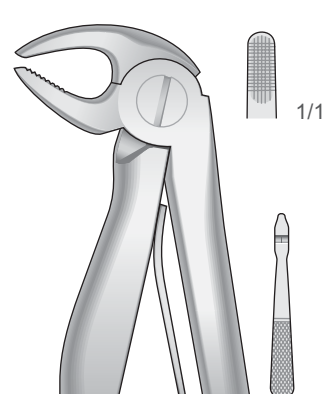

PEB-5
Fig. 5

Untere Schneidezähne
Lower incisors
Incisivi inferiori
Incisivos inferiores
Incisives inférieures

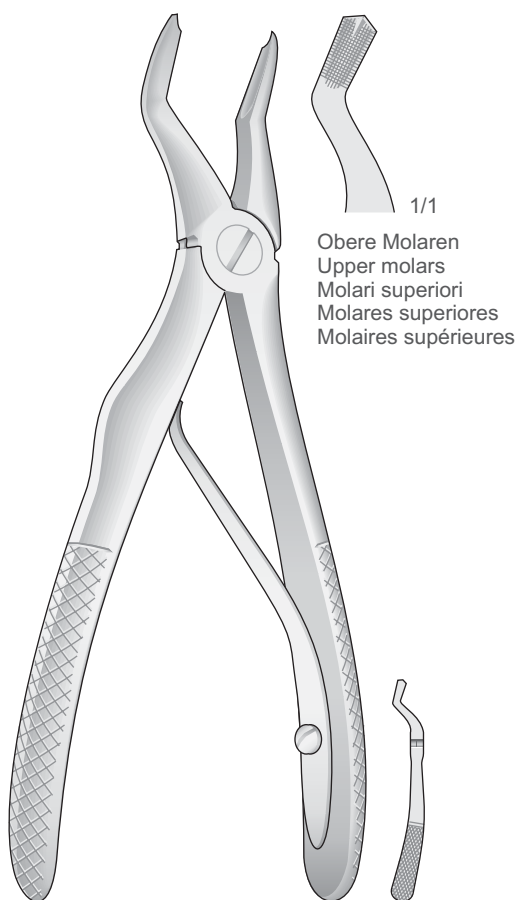

PEB-3

Obere Molaren
Upper molars
Molari superiori
Molares superiores
Molaires supérieures

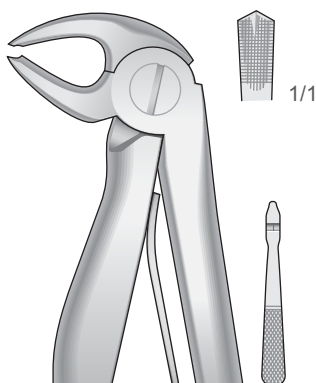

PEB-6
Fig. 6

Untere Molaren
Lower Molars
Molari inferiori
Molares inferiores
Molaires inférieures

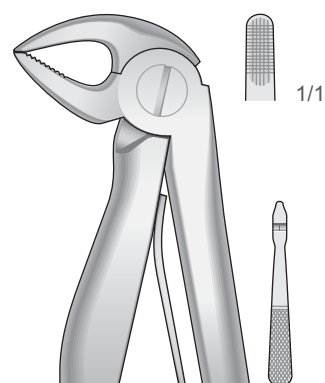

PEB-7
Fig. 7

Untere Wurzeln
Lower roots
Radici inferiori
Raíces inferiores
Racines inférieures



Zahnzangen
Extracting Forceps
Pinze per estrazione
Pinzas da extracciòn
Daviers

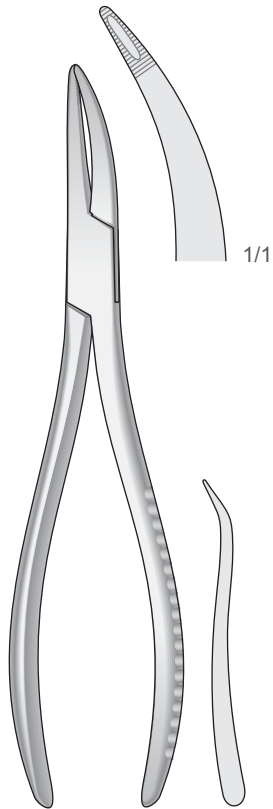

Obere Wurzeln, Universal
Upper roots, Universal
Radici superiori, Universale
Raices superiores, Universal
Racines superieures, Universel

**WITZEL
DK-26**
170 mm

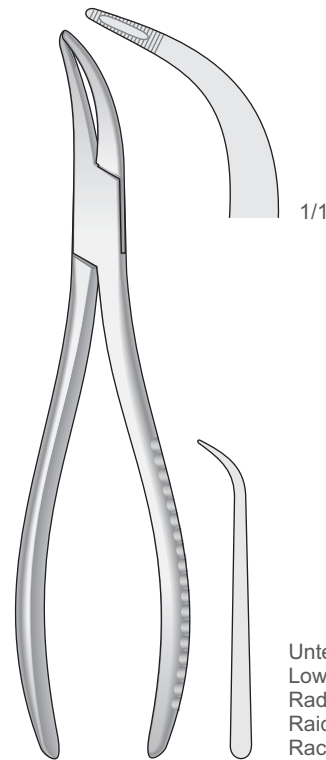

Untere Wurzeln, Universal
Lower roots, Universal
Radici inferiori, Universale
Raices inferiores, Universal
Racines inferieures, Universel

**WITZEL
DK-28**
165 mm

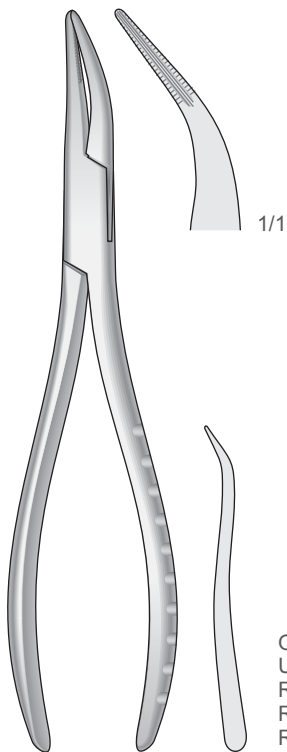

Obere Wurzeln, Universal
Upper roots, Universal
Radici superiori, Universale
Raices superiores, Universal
Racines superieures, Universel

400 (300)
165 mm

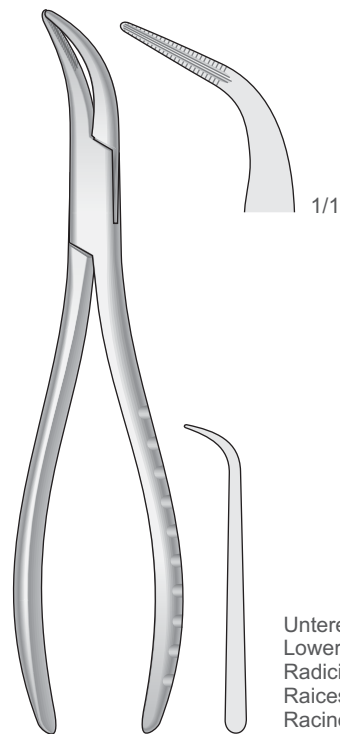

Untere Wurzeln, Universal
Lower roots, Universal
Radici inferiori, Universale
Raices inferiores, Universal
Racines inferieures, Universel

401 (301)
160 mm



Zahnzangen, Wurzelkanalinstrumente
Extracting Forceps, Nerve Instruments
Pinze per estrazione, strumenti per canali radicolari
Pinzas da extracciòn, instrumentos de canal
Daviers, instruments pour canaux radiculaires

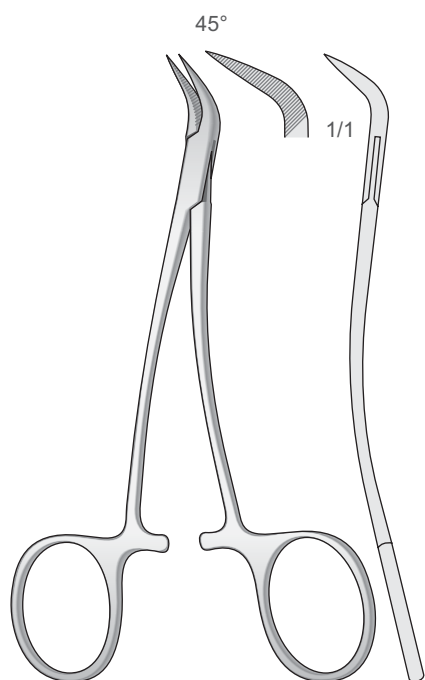

PEET
DR-40
120 mm

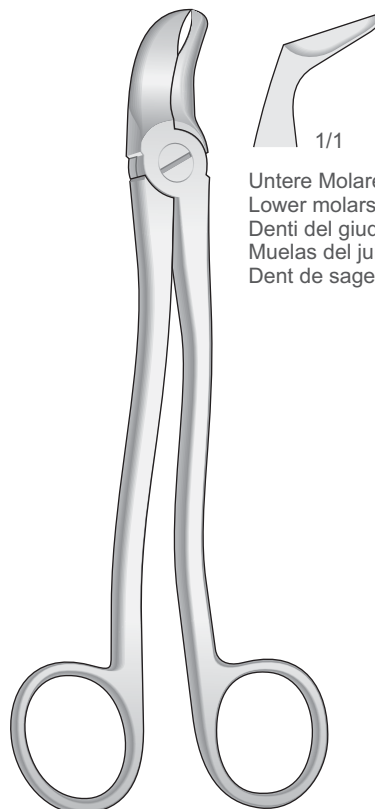

RO-1
175 mm

Untere Molaren und Weisheitszähne
Lower molars and wisdom teeth
Denti del giudizio e molari inferiori
Muelas del juicio y molares inferiores
Dent de sagesse et molaires inférieures

Wurzelfragmente
Root fragments
Frammenti di radici
Fragmentos de raíces
Fragments de racines

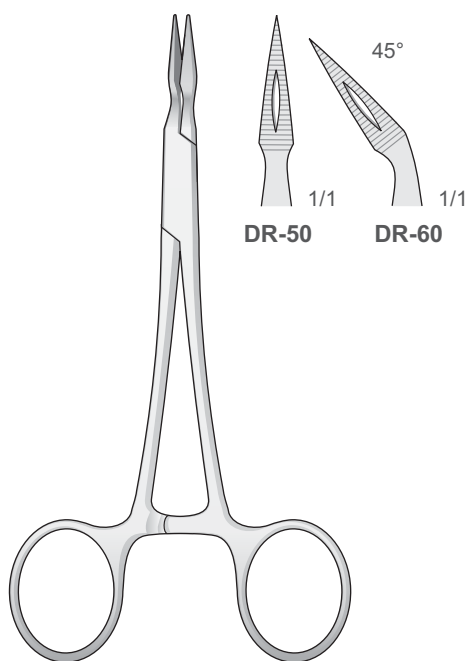

STIEGLITZ
DR-50/DR-60
140 mm

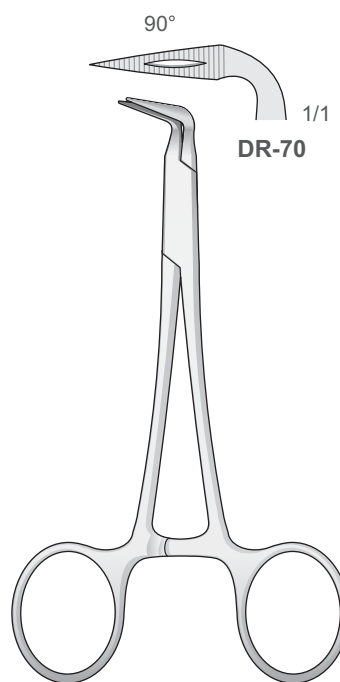

STIEGLITZ
DR-70
120 mm



Wurzelkanalinstrumente
Nerve Instruments
Strumenti per canali radicolari
Instrumentos de canal
Instruments pour canaux radiculaires

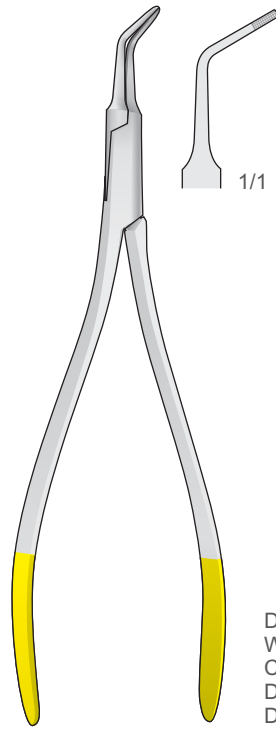

Diamantiert
With Diamond
Con diamante
Diamantada
Diamantées

DA-01M
130 mm

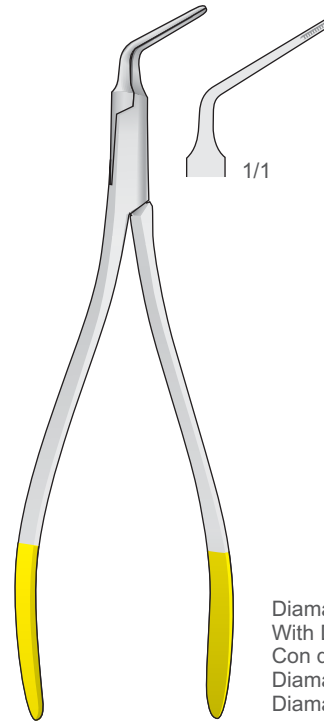

Diamantiert
With Diamond
Con diamante
Diamantada
Diamantées

DA-10
130 mm

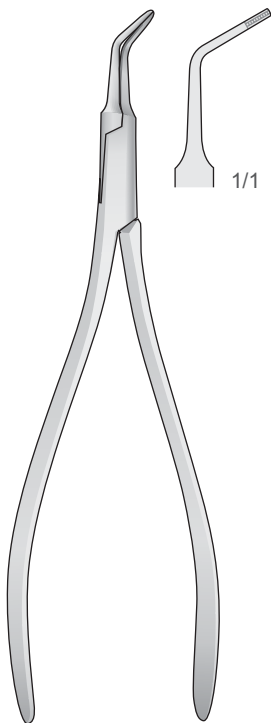

DA-01
130 mm

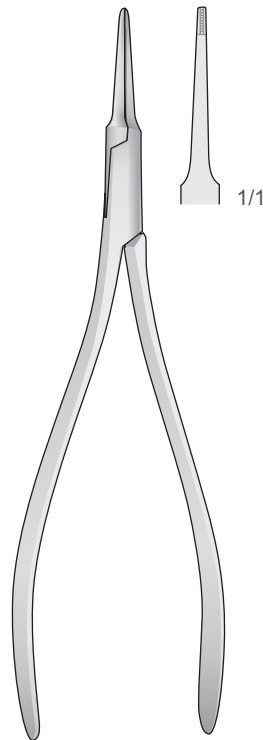

DA-02
130 mm

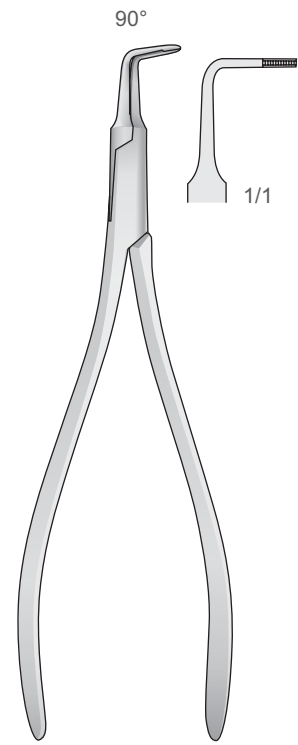

DA-03
125 mm

.2

Wurzelheber
Root Elevators
Leve per radici
Elevadores para raíces
Elévateurs à racines

Zahnärztliche Chirurgie
Dental surgery
Chirurgia dentale
Cirugia dental
Chirurgie dentaire

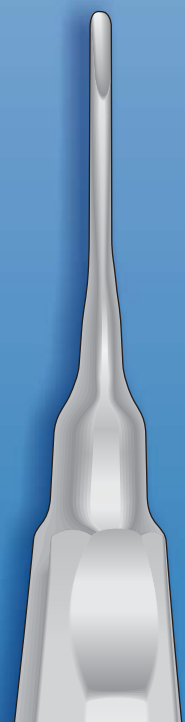

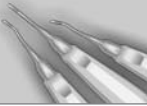

Wurzelheber
Root Elevators
Leve per radici
Elevadores para raíces
Elevateurs à racines

SMALL HANDLE

Luxatoren - Luxators
Lussatori - Luxadores
Luxateurs

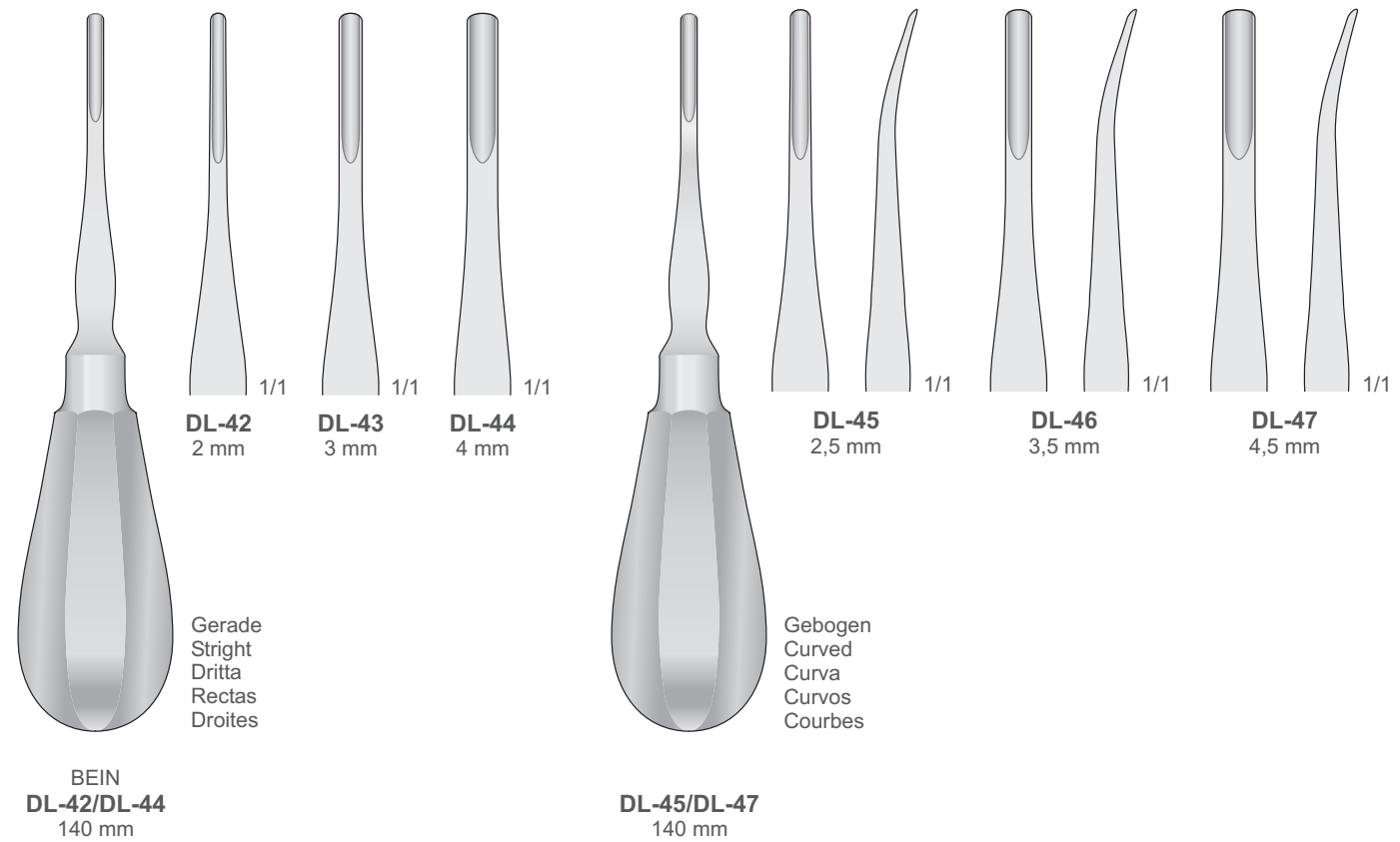
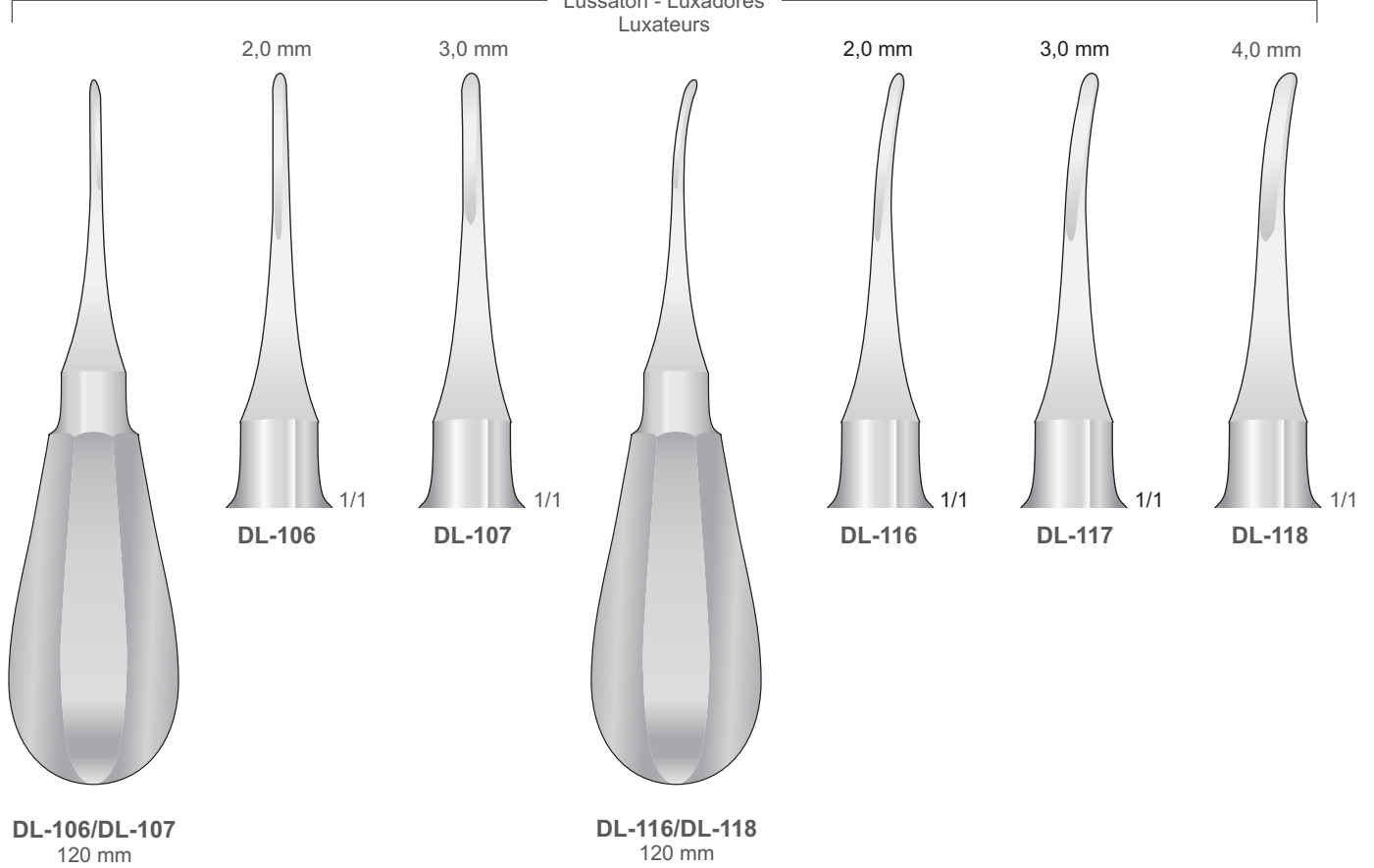

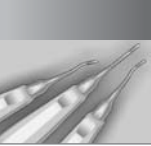

Wurzelheber
Root Elevators
Leve per radici
Elevadores para raices
Elevateurs à racines

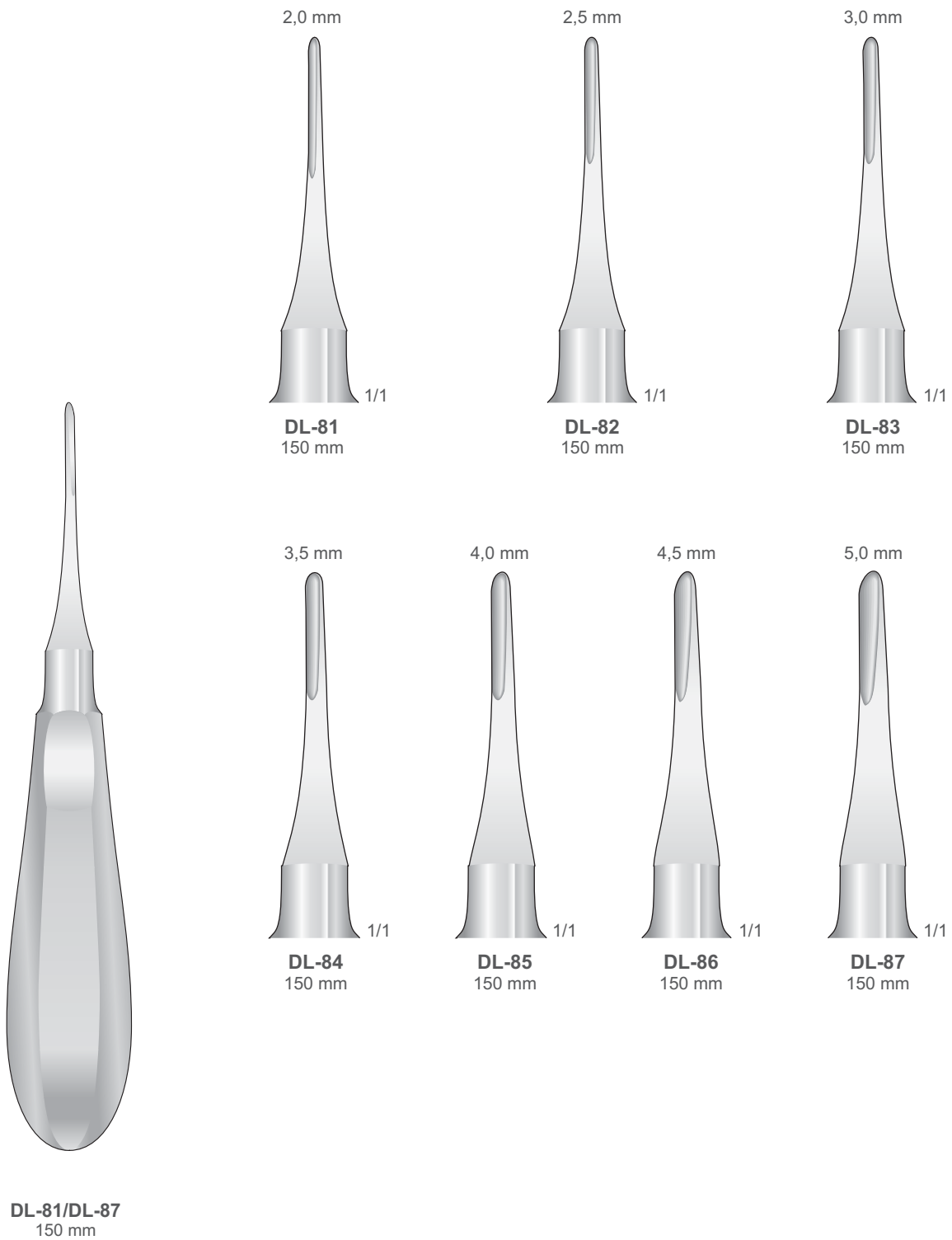

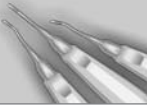

Wurzelheber
Root Elevators
Leve per radici
Elevadores para raices
Elevateurs à racines

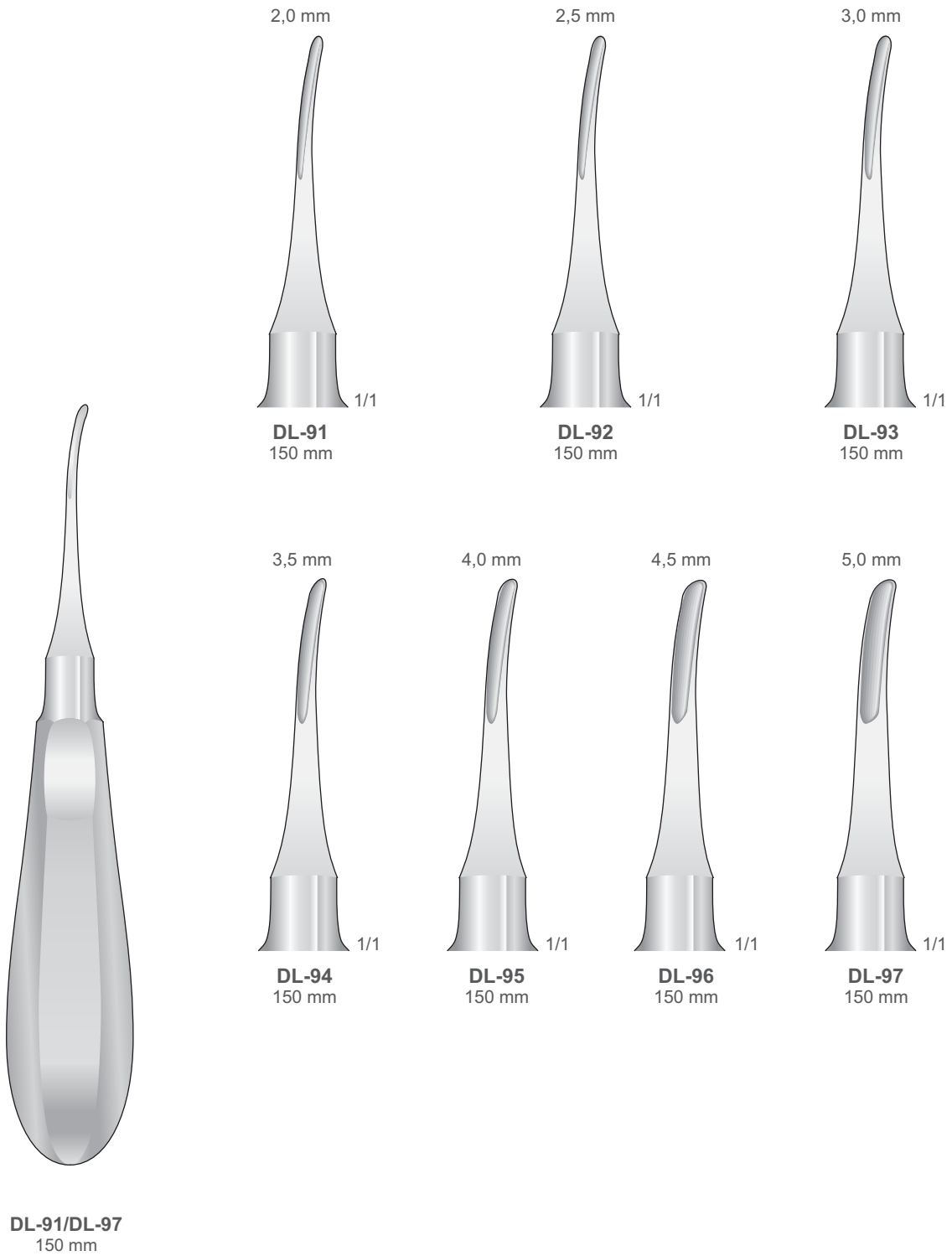

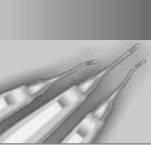

Wurzelheber
Root Elevators
Leve per radici
Elevadores para raices
Elevateurs à racines

Luxatoren
Luxators
Lussatori
Luxadores
Luxateurs

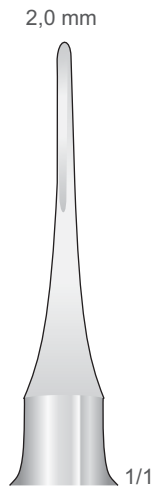

2,0 mm

1/1

DL-102
150 mm

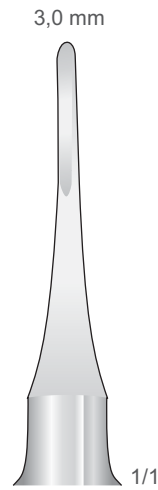

3,0 mm

1/1

DL-103
150 mm

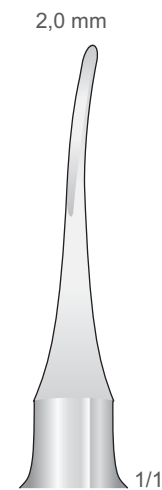

2,0 mm

1/1

DL-112
150 mm

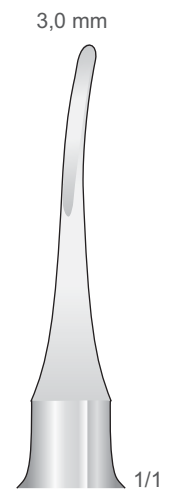

3,0 mm

1/1

DL-113
150 mm

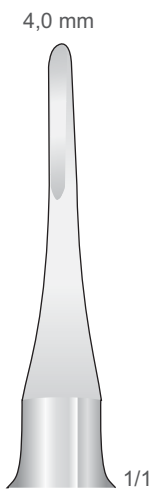

4,0 mm

1/1

DL-104
150 mm

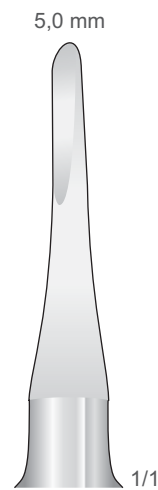

5,0 mm

1/1

DL-105
150 mm

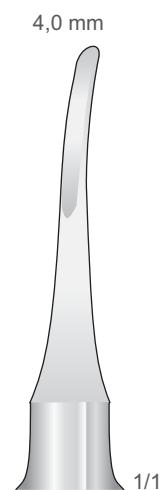

4,0 mm

1/1

DL-114
150 mm

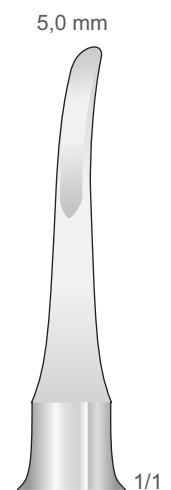

5,0 mm

1/1

DL-115
150 mm

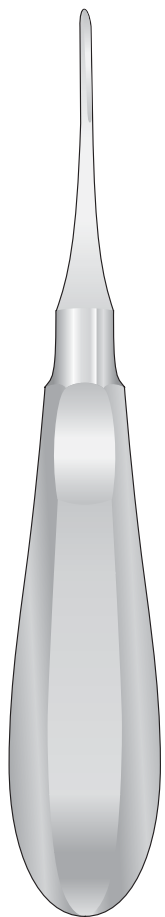

DL-102/DL-105
150 mm

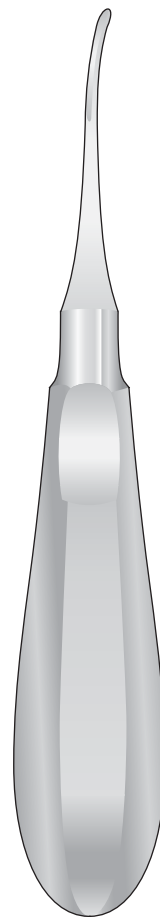

DL-112/DL-115
150 mm

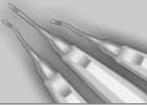

Wurzelheber
Root Elevators
Leve per radici
Elevadores para raices
Elevateurs à racines

Wurzelspitzenheber
Root fragment Elevators
Leve per frammenti di radice
Elevadores para fragmentos de raices
Elévateurs de fragments de racines

Gezahnt
Serrated
Dentellata
Dentada
Dentelé



**HEIDBRINK
HE-1**
140 mm



**HEIDBRINK
HE-2**
140 mm



**HEIDBRINK
HE-3**
140 mm

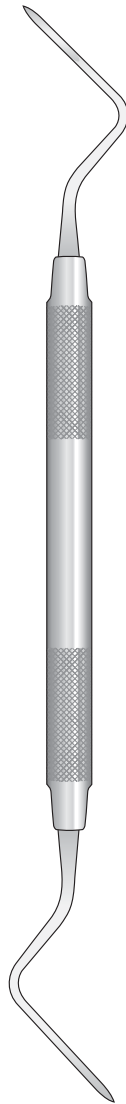

**HEIDBRINK
725-1/2**
195 mm

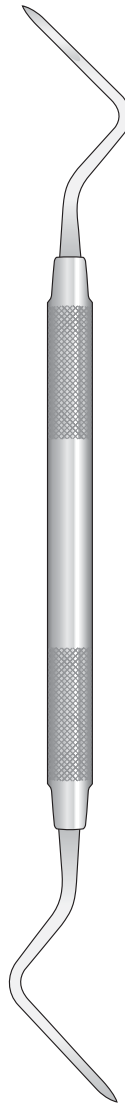

**HEIDBRINK
725-3/4**
195 mm

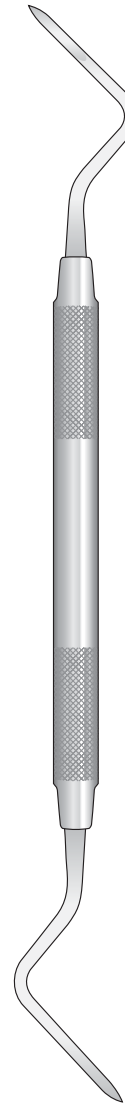

**HEIDBRINK
725-5/6**
195 mm

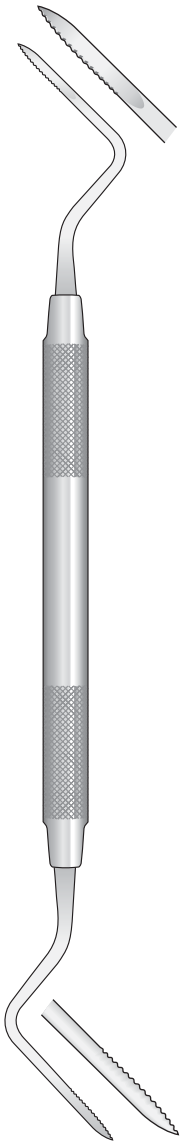

**HEIDBRINK
725-3/4S**
195 mm

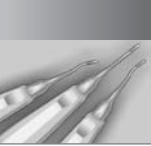

Wurzelheber
Root Elevators
Leve per radici
Elevadores para raices
Elevateurs à racines

Extraktionshebel für obere Weisheitszähne
Luxator for upper wisdom teeth
Leva per estrazione dente del giudizio superiore
Elevador de extracción de muelas del juicio superiores
Levier d'extraction pour dent de sagesse supérieures

Wurzelheber
Root Elevators
Leve per radici
Elevadores para raices
Elevateurs de racines



ROSIN
DL-58
160 mm



WARWICK-JAMES
DL-20
160 mm



WARWICK-JAMES
DL-21
155 mm



WARWICK-JAMES
DL-22
155 mm

Obere
Upper
Superiori
Superiores
Supérieures

Untere
Lower
Inferiori
Inferiores
Inférieures

Untere
Lower
Inferiori
Inferiores
Inférieures

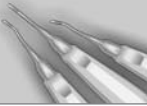

Wurzelheber
Root Elevators
Leve per radici
Elevadores para raices
Elevateurs à racines

Eine seite gezahnt
One side serrated
Un lato dentellato
Dentadura mäs lado
Dentelure sur un côté

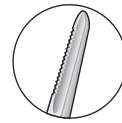
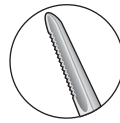

Fig. 94



DL-76
155 mm

Fig. 95



DL-77
155 mm

Fig. 100L



DL-78
155 mm

Fig. 100R



DL-79
155 mm

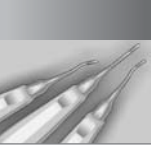

Wurzelheber
Root Elevators
Leve per radici
Elevadores para raíces
Elevateurs à racines

Gezahnt
Serrated
Dentellate
Dentadas
Dentelé

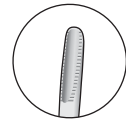
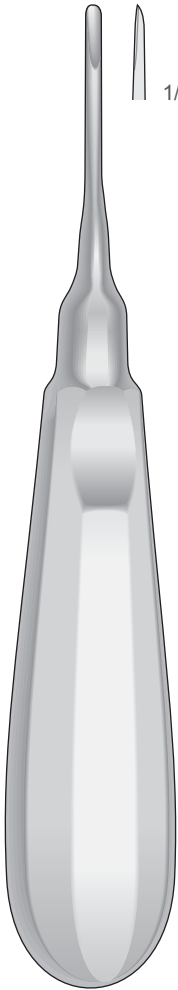
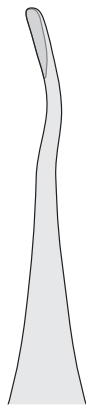

Fig. 301



APEXO
DL-34
160 mm

Fig. 302



DL-35

Fig. 303

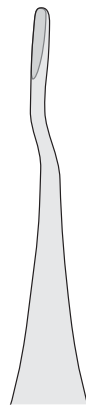

DL-36

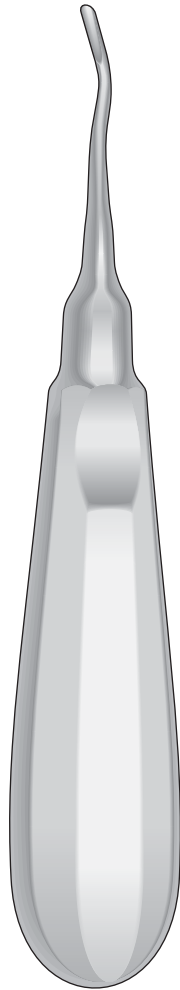

APEXO
DL-35/DL-36
160 mm

Fig. 77L

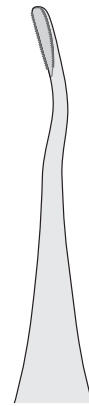

DL-37

Fig. 77R

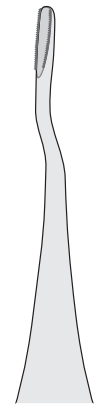

DL-38

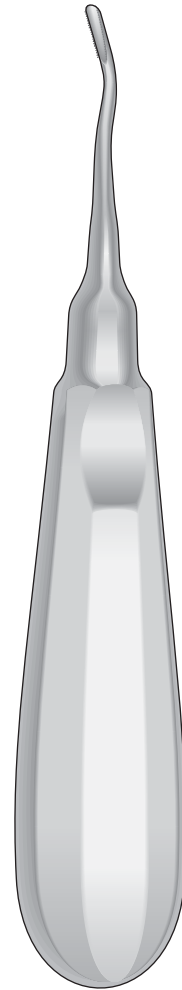

APEXO
DL-37/DL-38
160 mm

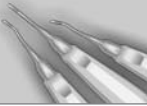

Wurzelheber
Root Elevators
Leve per radici
Elevadores para raices
Elevateurs à racines

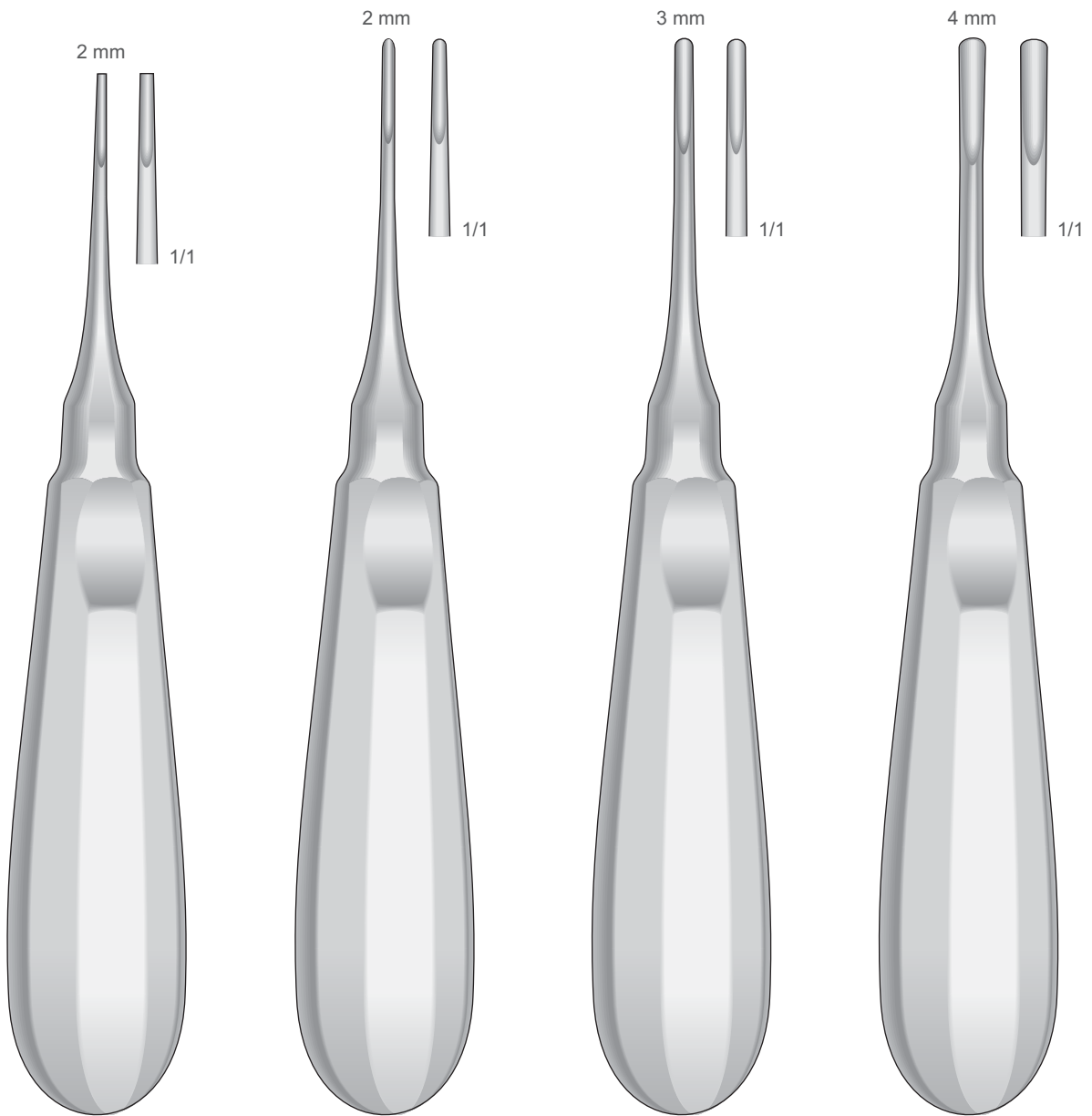

BEIN-1T
150 mm

BEIN-2
155 mm

BEIN-3
155 mm

BEIN-4
155 mm

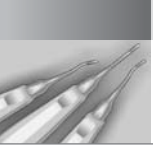

Wurzelheber
Root Elevators
Leve per radici
Elevadores para raíces
Elevateurs à racines

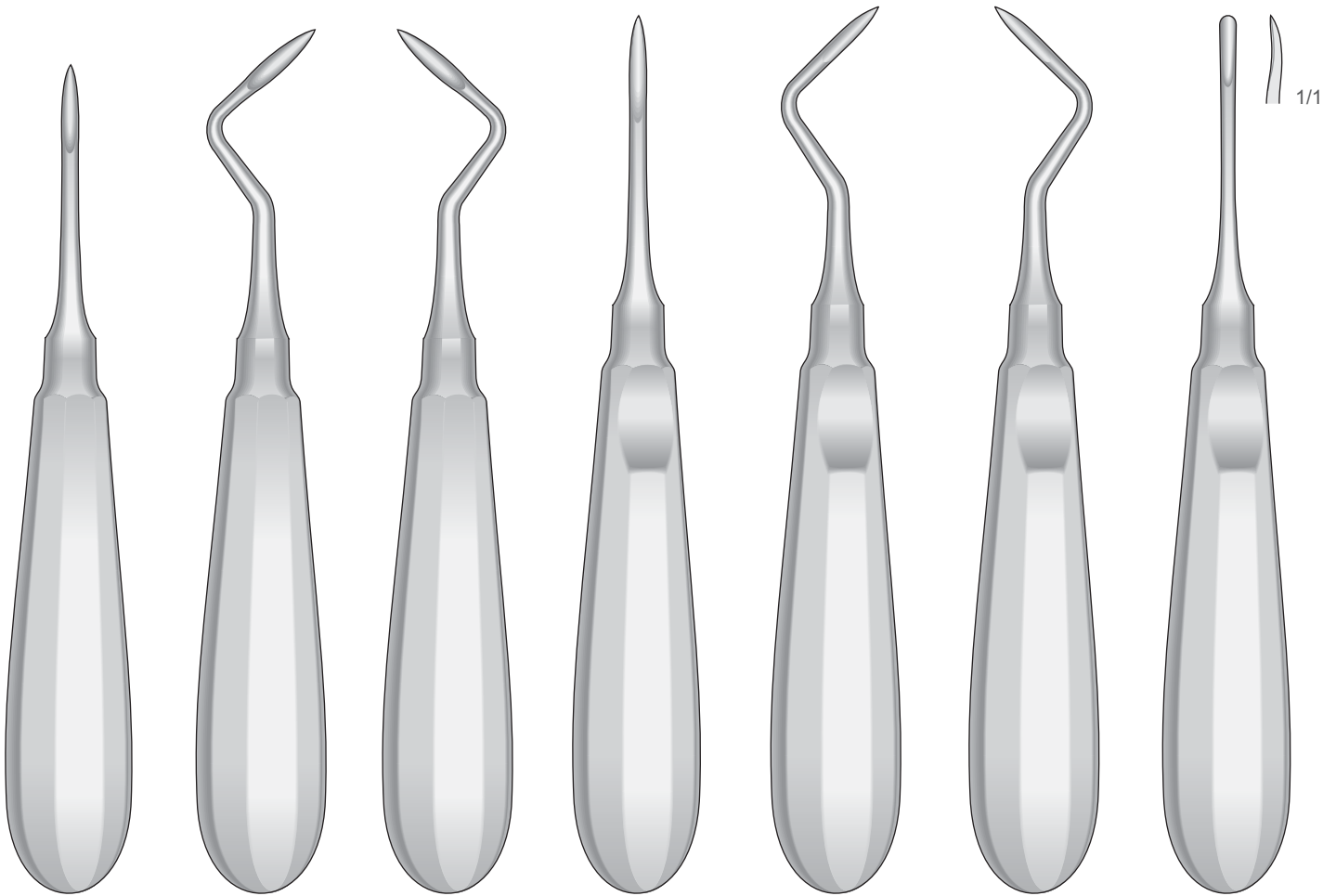

FLOHR-1
140 mm

FLOHR-2
150 mm

FLOHR-3
150 mm

APICAL-1
155 mm

APICAL-2
155 mm

APICAL-3
155 mm

APICAL-4
155 mm

Wurzelheber
Root Elevators
Leve per radici
Elevadores para raices
Elevateurs à racines

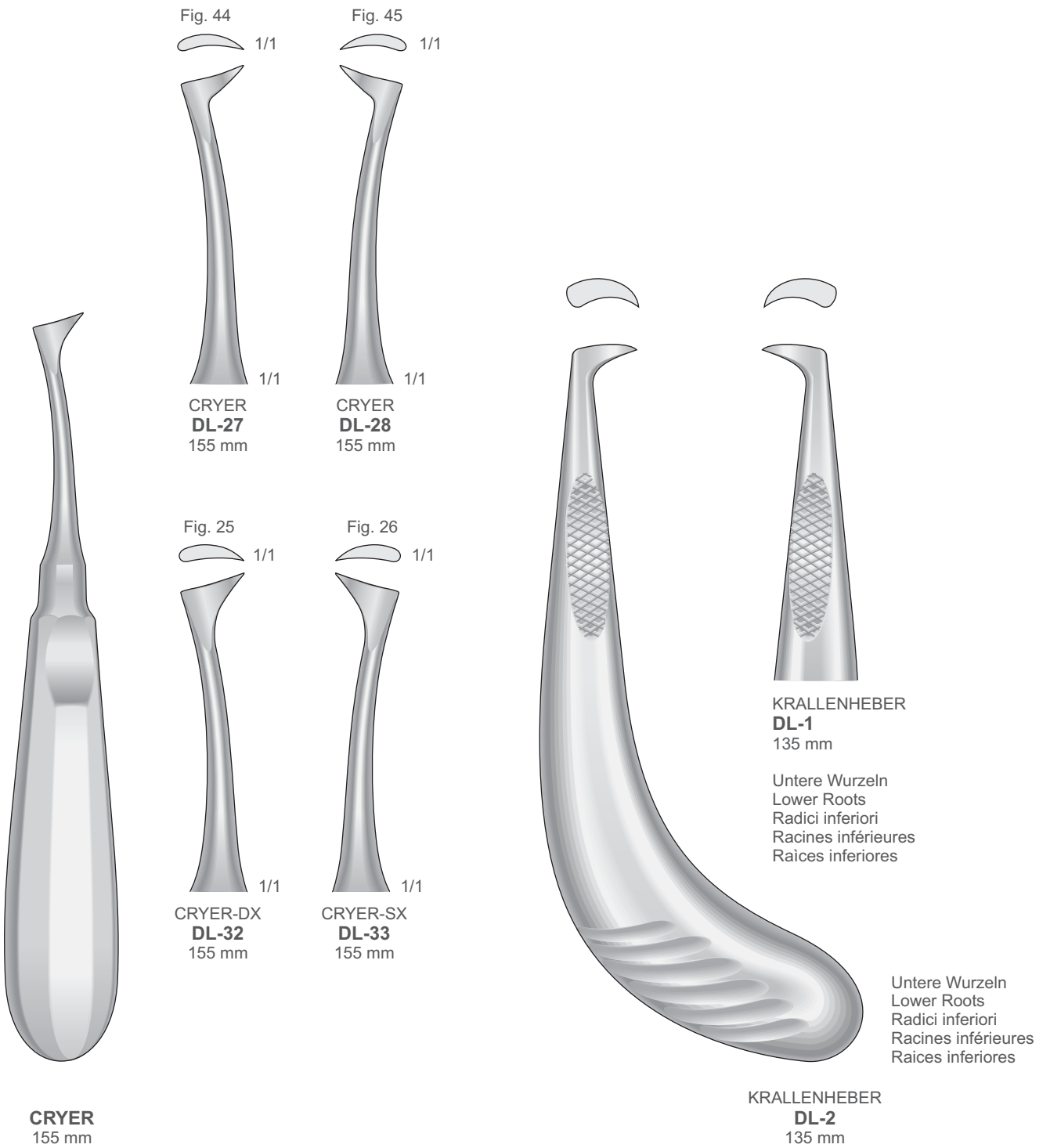

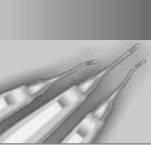

Wurzelheber
Root Elevators
Leve per radici
Elevadores para raices
Elevateurs à racines

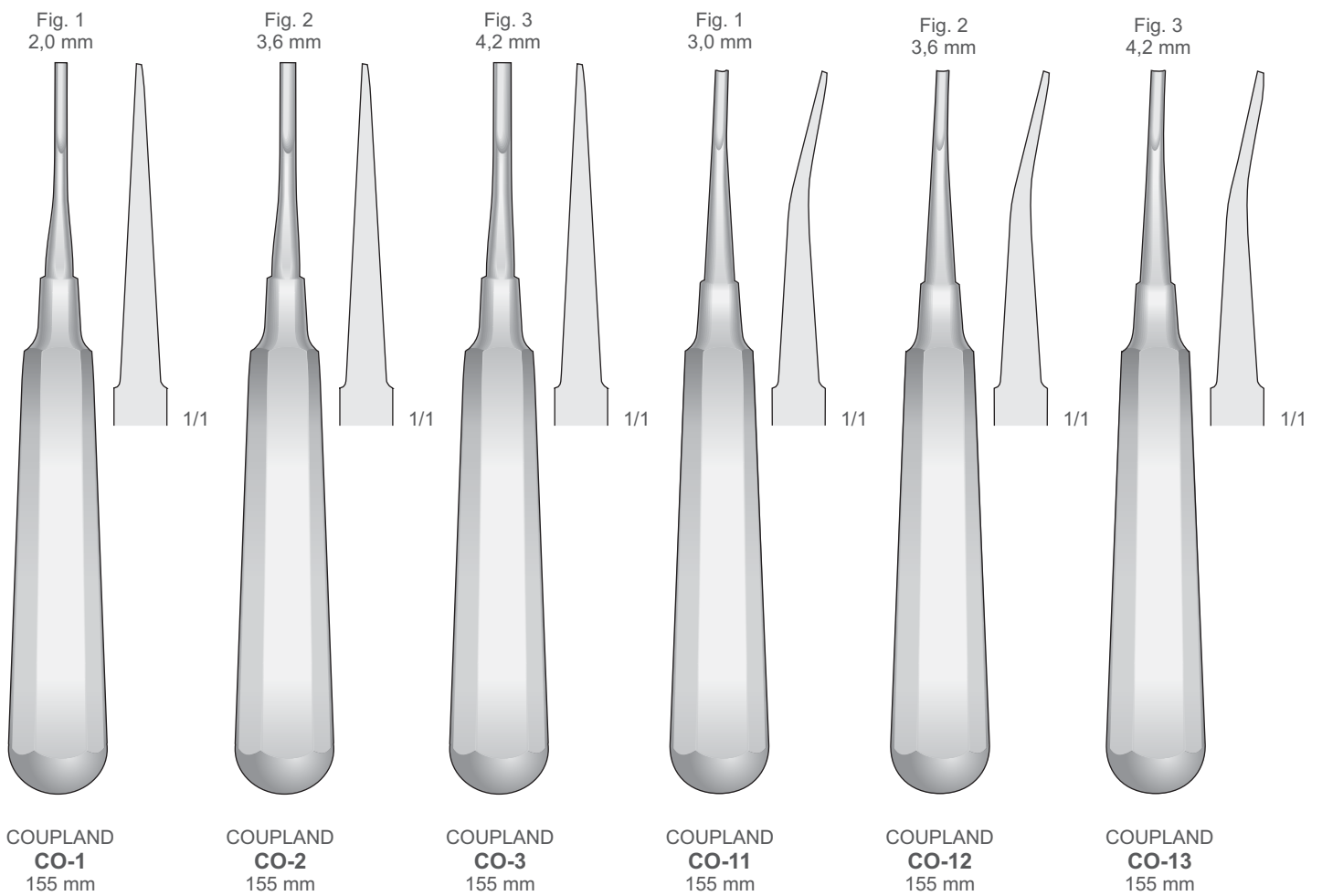

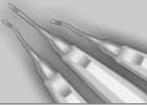

Wurzelheber
Root Elevators
Leve per radici
Elevadores para raices
Elevateurs à racines

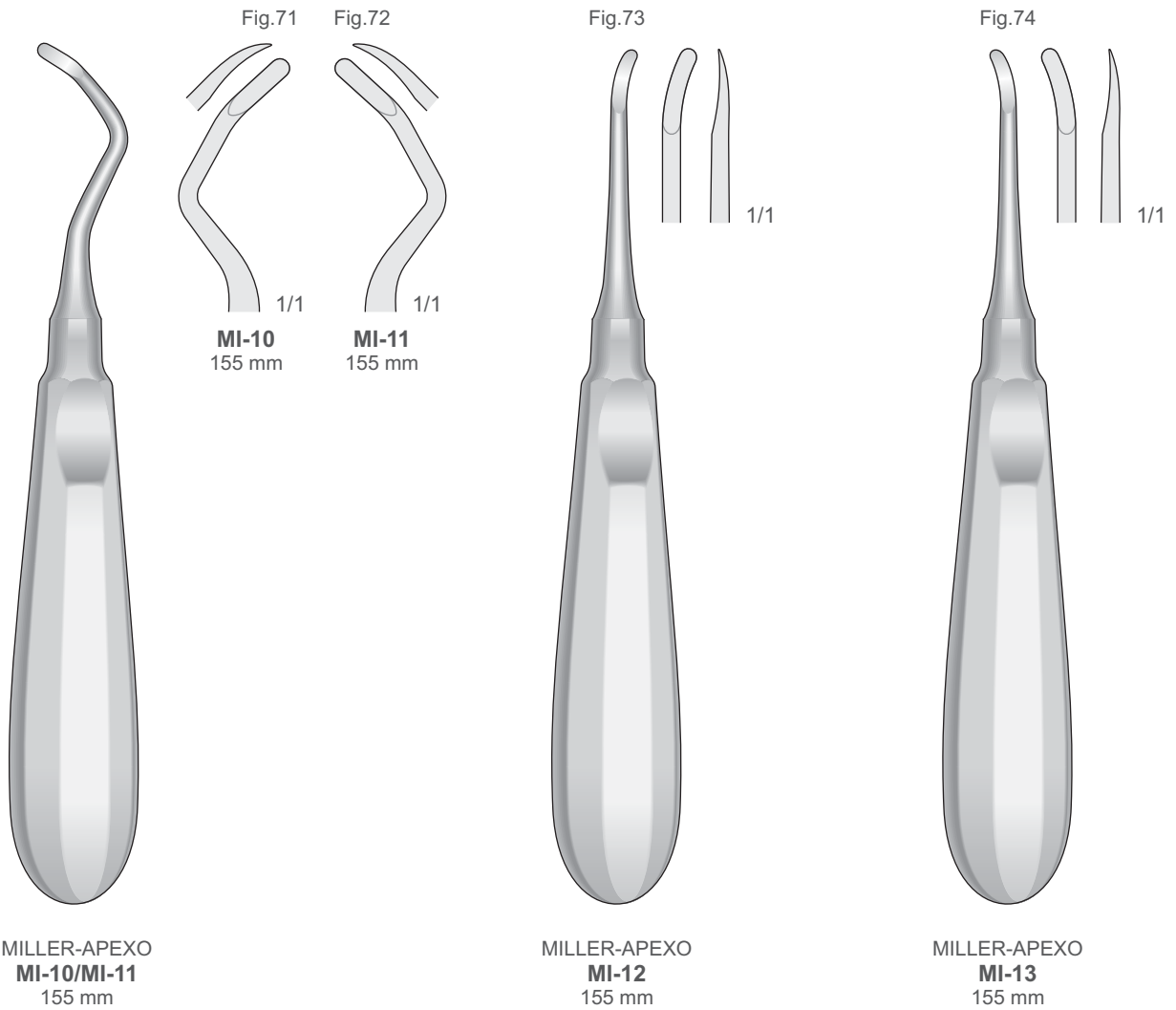

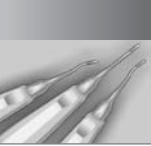

Wurzelheber
Root Elevators
Leve per radici
Elevadores para raíces
Elevateurs à racines

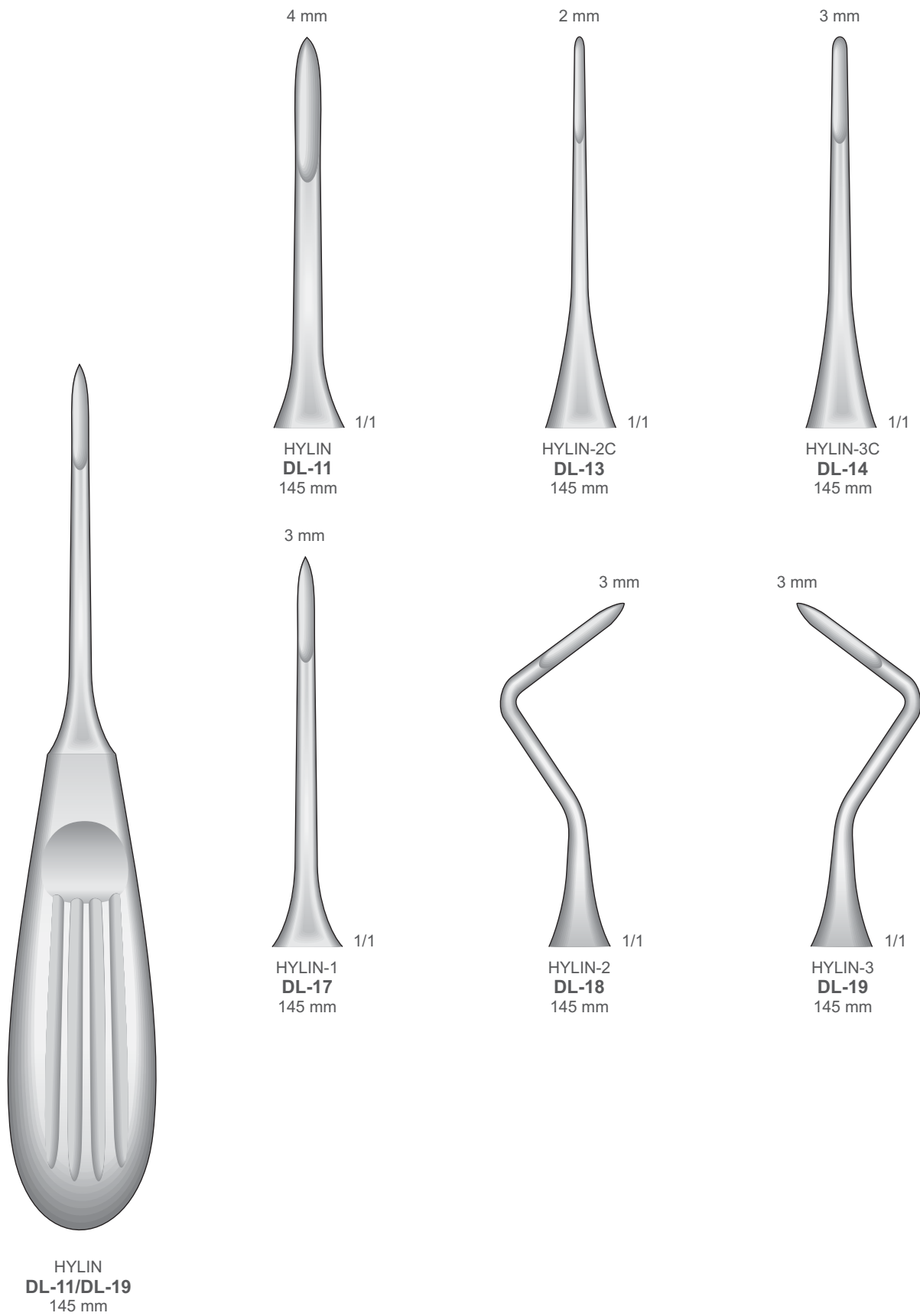

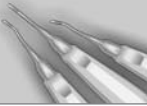

Wurzelheber
Root Elevators
Leve per radici
Elevadores para raices
Elevateurs à racines

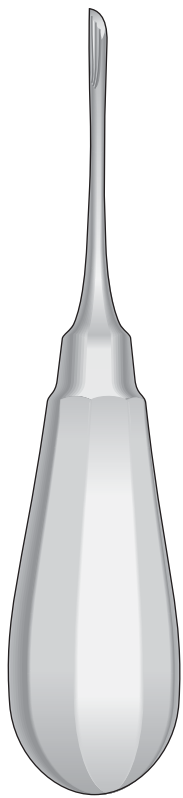

**KOPP
DL-30**
130 mm

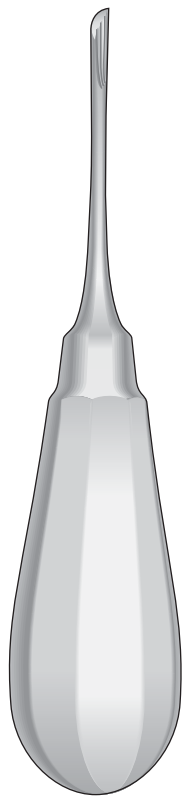

**KOPP
DL-31**
130 mm

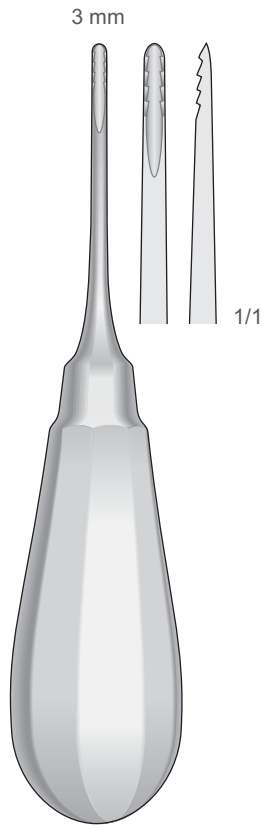

BEIN-1Z
130 mm

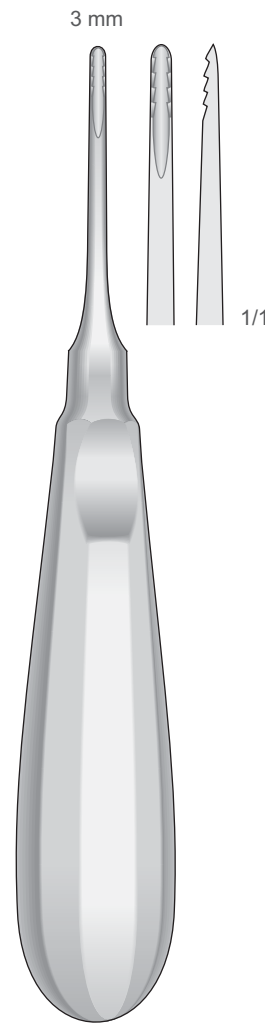

BEIN-2Z
155 mm

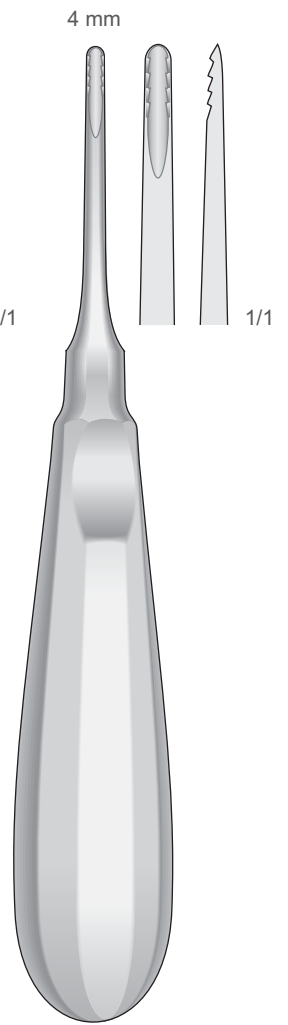

**LINDO-LEVIEN
BEIN-4Z**
155 mm

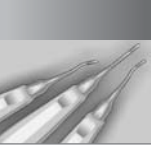

Wurzelheber
Root Elevators
Leve per radici
Elevadores para raices
Elevateurs à racines

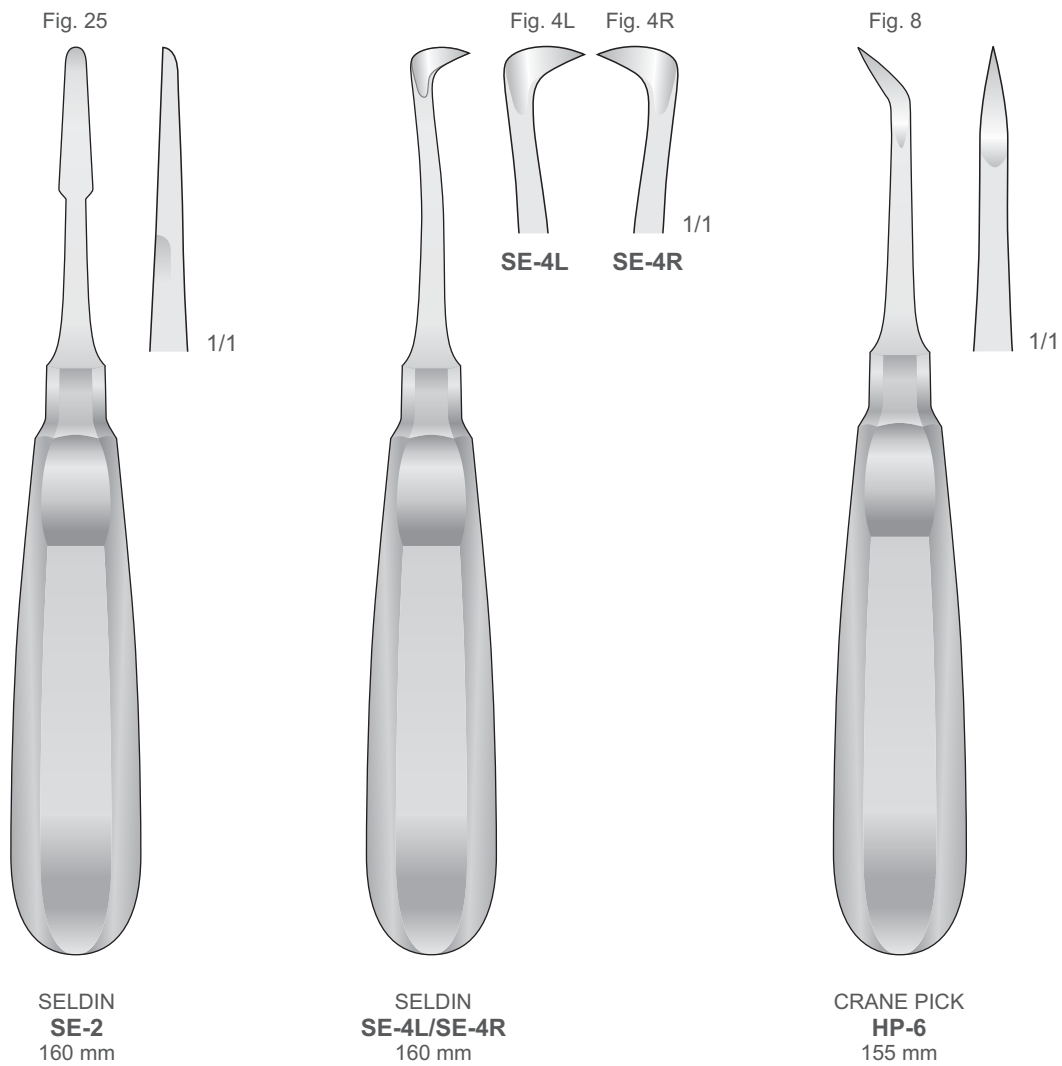

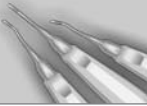

Wurzelheber
Root Elevators
Leve per radici
Elevadores para raices
Elevateurs à racines

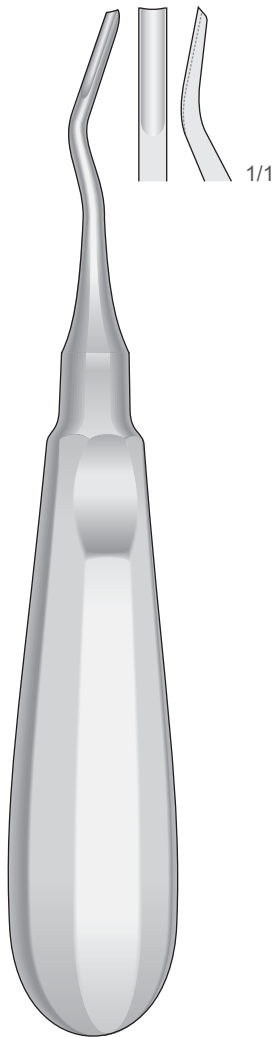

DL-54
160 mm

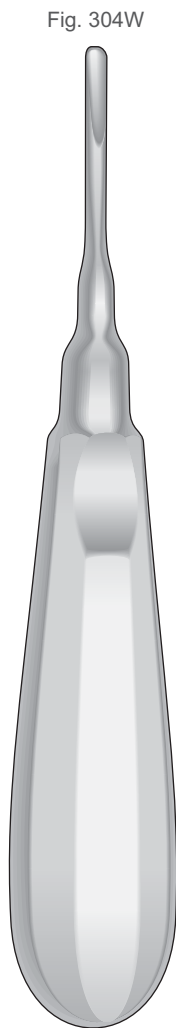

**SELDIN
DL-48**
155 mm

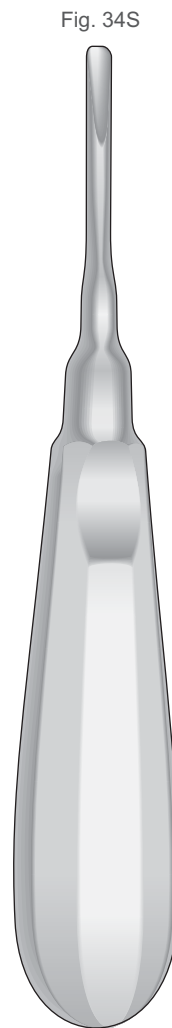

**SELDIN
DL-49**
155 mm

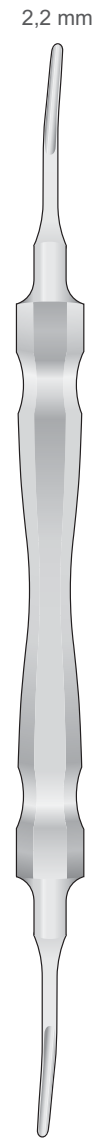

**FAHRENKRUG
DL-05**
190 mm

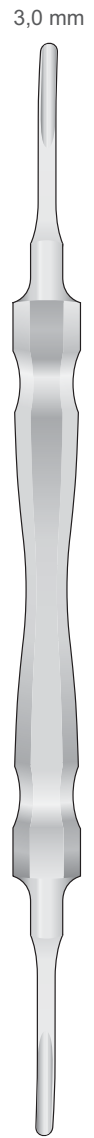

**FAHRENKRUG
DL-06**
190 mm

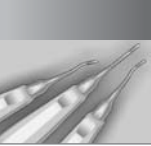

Wurzelheber
Root Elevators
Leve per radici
Elevadores para raíces
Elevateurs à racines

Fig. 6

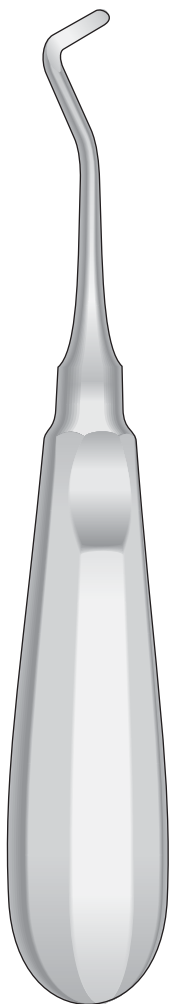

POTT
DL-98
160 mm

Fig. 7

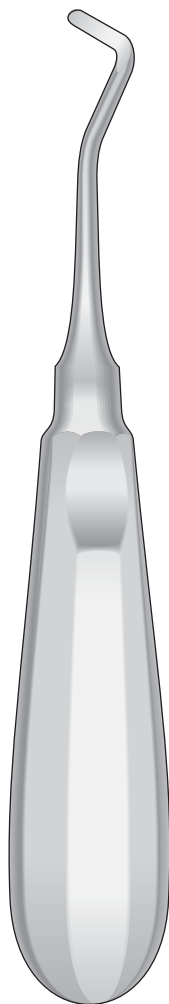

POTT
DL-99
160 mm

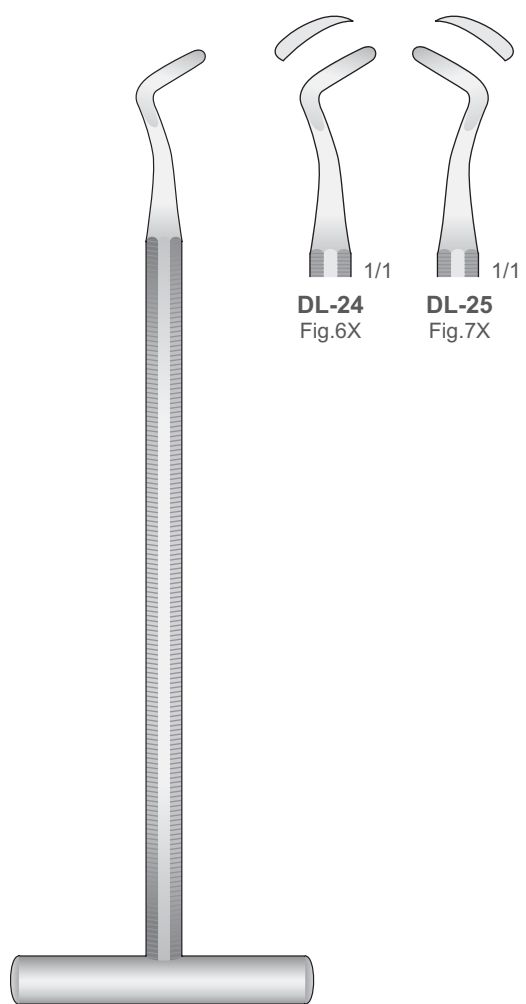

POTT
DL-24/DL-25
155 mm

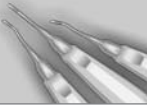

Wurzelheber
Root Elevators
Leve per radici
Elevadores para raices
Elevateurs à racines

Syndesmotome
Syndesmotomes
Sindesmotomi
Syndesmôtomos
Syndesmotomes

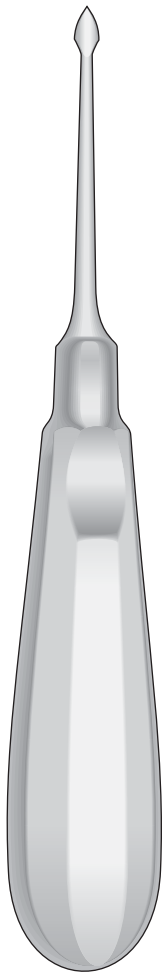

**BERNARD
DL-73/DL-124**

Gerade
Straight
Diritto
Rectas
Droites



**BERNARD
DL-73**
150 mm

Links
Left
Sinistra
A la izquierda
À gauche

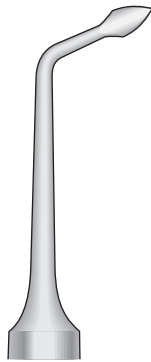

**BERNARD
DL-74**
140 mm

Rechts
Right
Destro
A la derecha
À droite

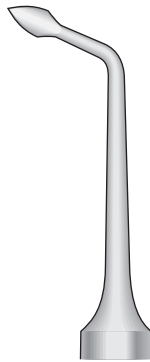

**BERNARD
DL-75**
140 mm

Bajonett - Bayonet
Baionetta - Bayoneta
Baionnette

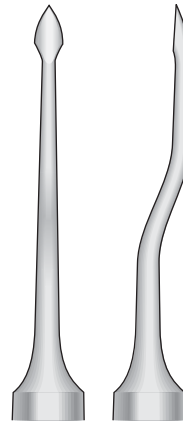

**BERNARD
DL-123**
150 mm

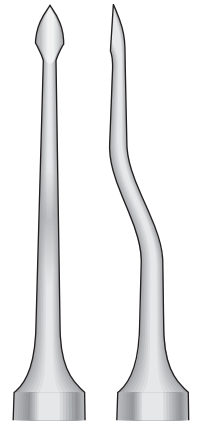

**BERNARD
DL-124**
150 mm

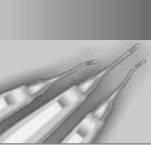

Wurzelheber
 Root Elevators
 Leve per radici
 Elevadores para raices
 Elevateurs à racines

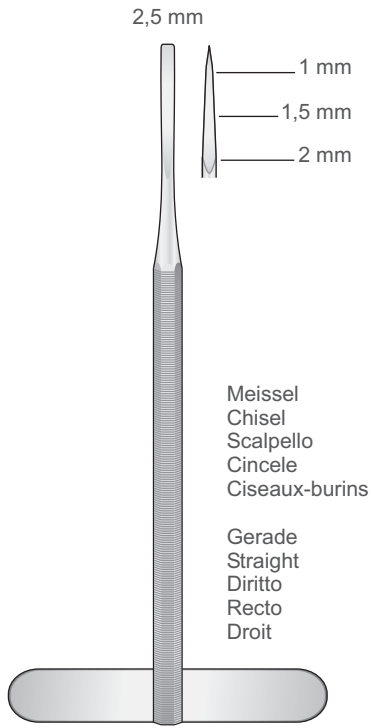

DL-88
130 mm

Meissel
 Chisel
 Scalpello
 Cincele
 Ciseaux-burins

Gerade
 Straight
 Diritto
 Recto
 Droit

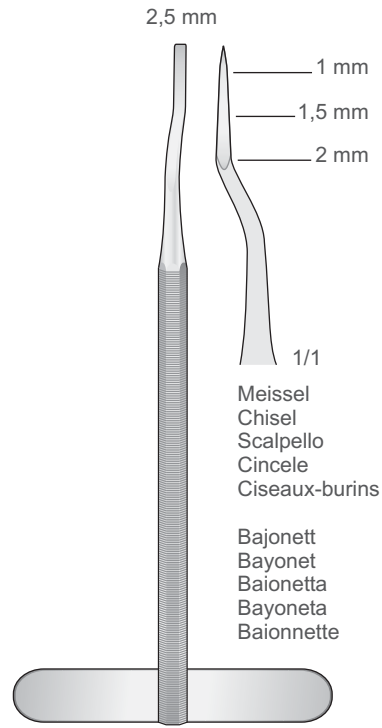

DL-89
130 mm

Meissel
 Chisel
 Scalpello
 Cincele
 Ciseaux-burins

Bajonett
 Bayonet
 Baionetta
 Bayoneta
 Baionnette

Syndesmotome
 Syndesmotomes
 Sindesmotomo
 Syndesmòtomos
 Syndesmotomes



DL-63
158 mm

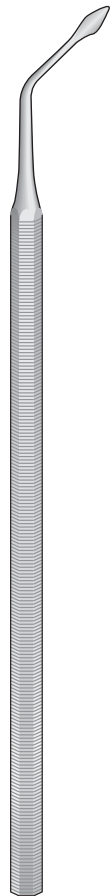

DL-62
152 mm

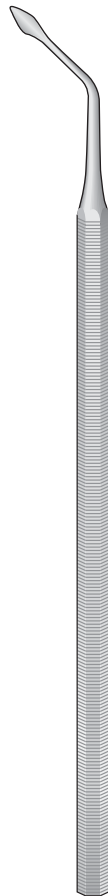

DL-61
152 mm

Raspatorien
 Raspatories
 Scollaperiosteo
 Legras
 Rugines



DL-59
150 mm

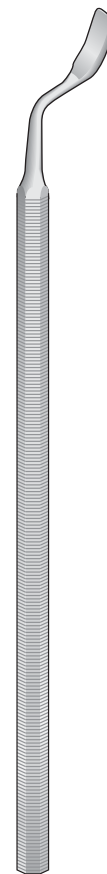

DL-68
150 mm

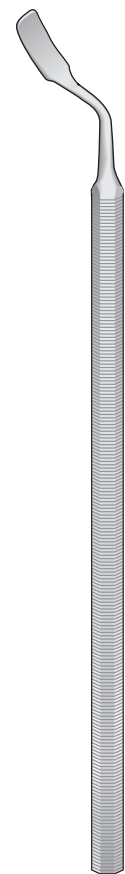

DL-69
150 mm

Wurzelheber
Root Elevators
Leve per radici
Elevadores para raices
Elevateurs à racines

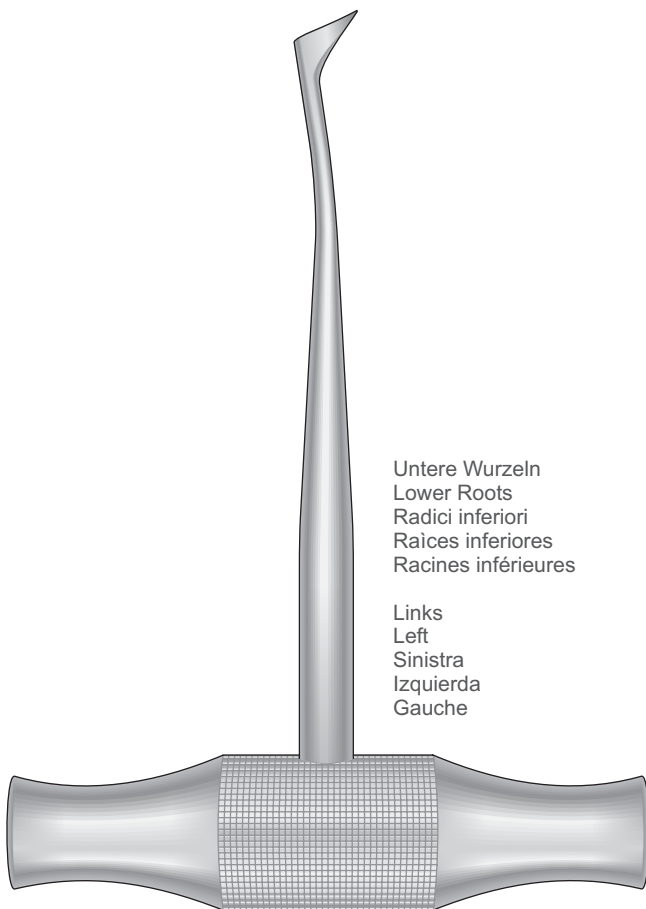

Untere Wurzeln
Lower Roots
Radici inferiori
Raíces inferiores
Racines inférieures

Links
Left
Sinistra
Izquierda
Gauche

WINTER
DL-100
Fig.1

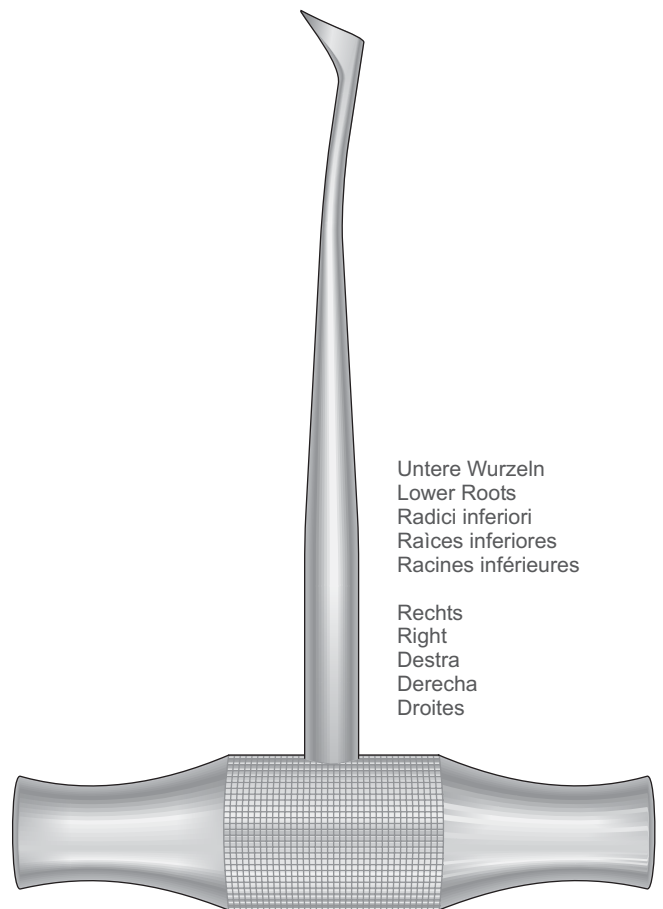

Untere Wurzeln
Lower Roots
Radici inferiori
Raíces inferiores
Racines inférieures

Rechts
Right
Destra
Derecha
Droites

WINTER
DL-101
Fig.2

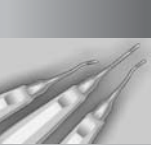

Wurzelheber
Root Elevators
Leve per radici
Elevadores para raices
Elevateurs à racines

Fig. 1L

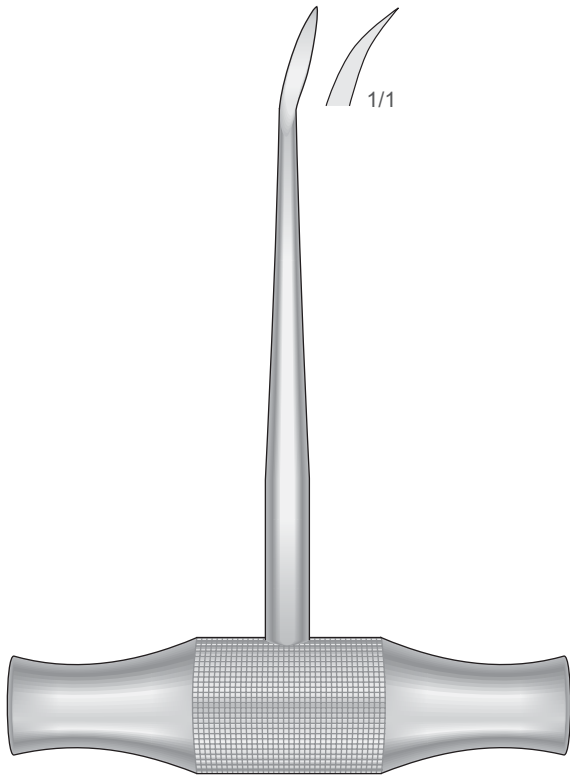

WINTER
DL-64
120 mm

Fig. 1R



WINTER
DL-65
120 mm

Fig. 14L



WINTER
DL-66
125 mm

Fig. 14R



WINTER
DL-67
125 mm

Wurzelheber
Root Elevators
Leve per radici
Elevadores para raices
Elevateurs à racines

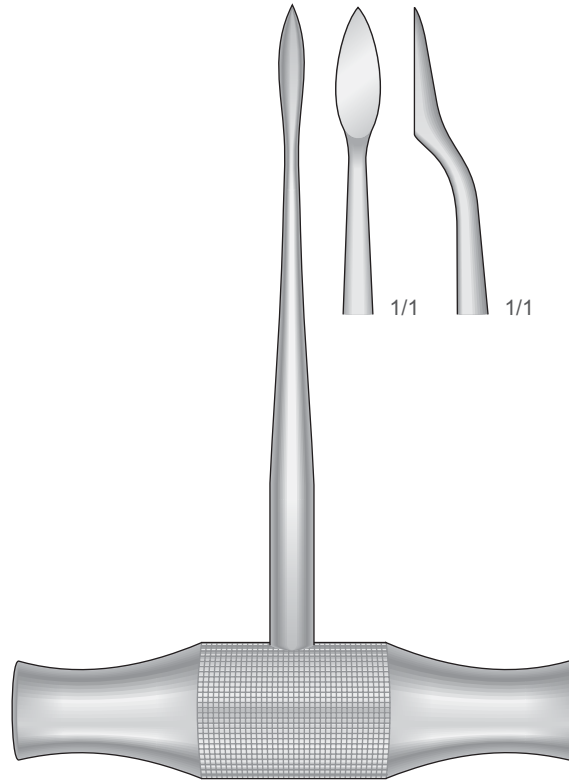

LECLUSE
DL-90
130 mm

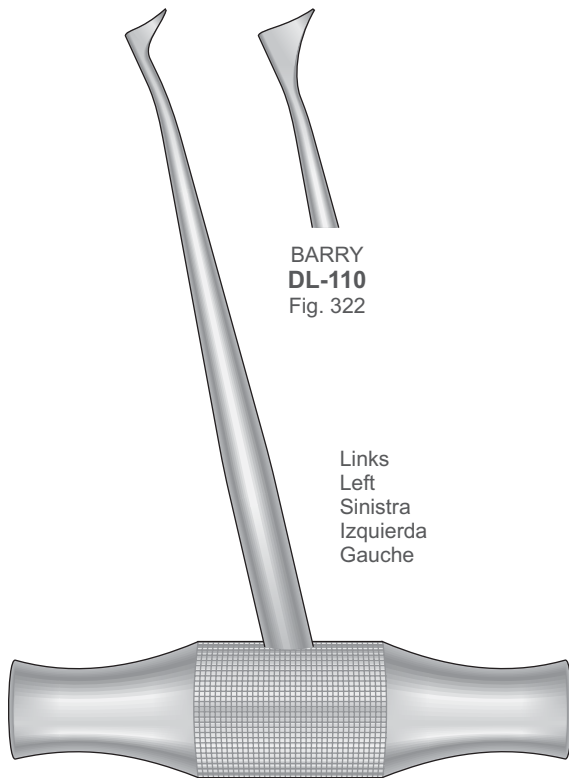

BARRY
DL-110
Fig. 322

Links
Left
Sinistra
Izquierda
Gauche

BARRY
DL-108 Fig. 320
115 mm

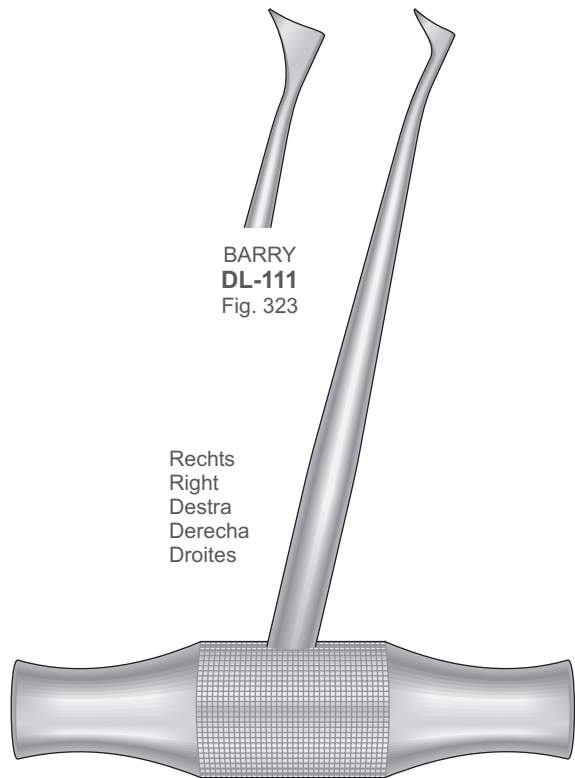

BARRY
DL-111
Fig. 323

Rechts
Right
Destra
Derecha
Droites

BARRY
DL-109 Fig. 321
115 mm

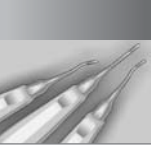

Wurzelheber
Root Elevators
Leve per radici
Elevadores para raíces
Elevateurs à racines

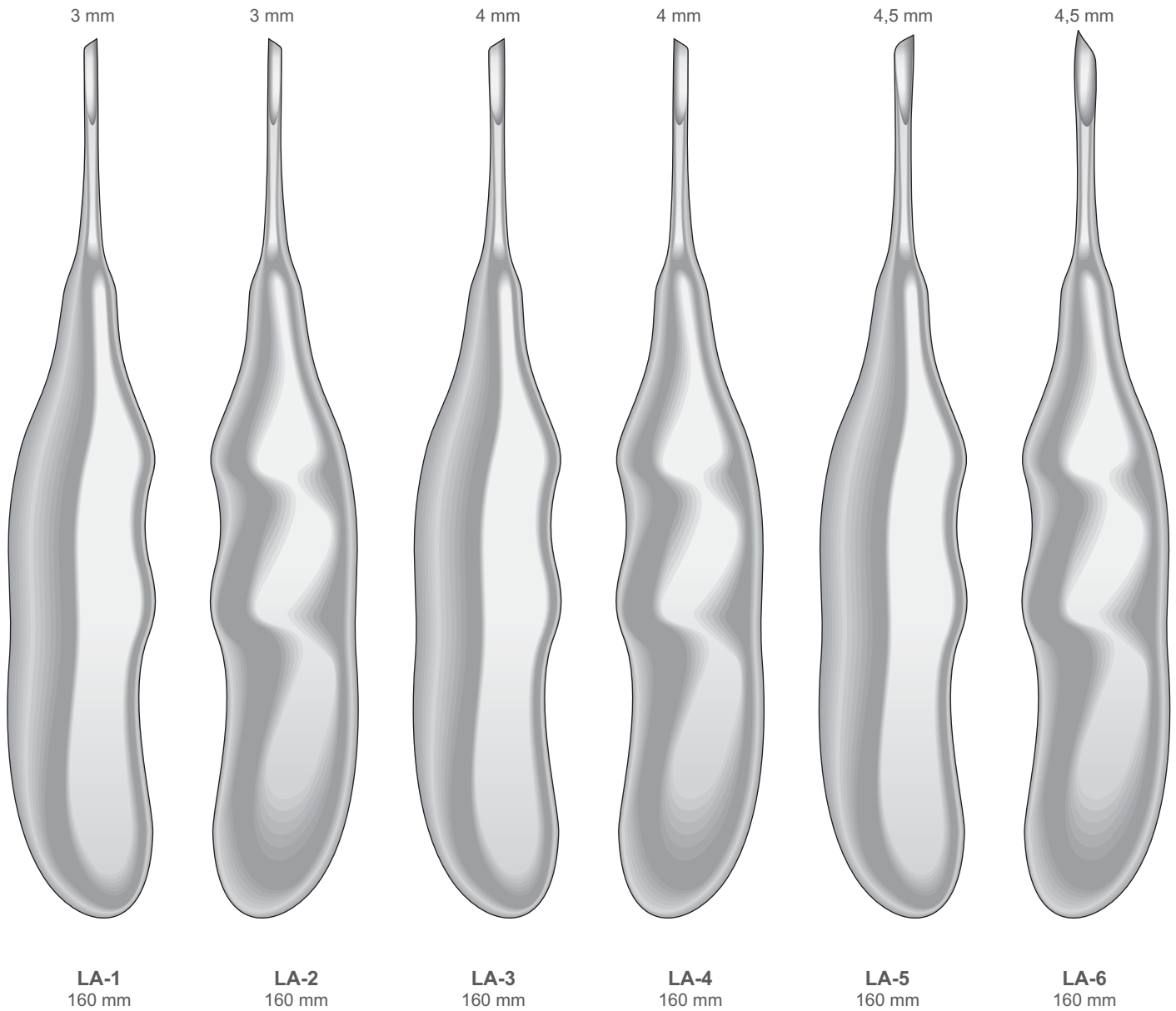

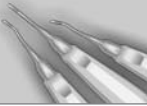

Wurzelheber
Root Elevators
Leve per radici
Elevadores para raíces
Elevateurs à racines



LA-7
160 mm



LA-8
160 mm



LA-9
160 mm



LA-10
160 mm

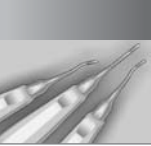

Wurzelheber
Root Elevators
Leve per radici
Elevadores para raíces
Elevateurs à racines

2 mm



LA-11
155 mm

3 mm



LA-12
155 mm

4 mm



LA-13
155 mm



LA-16
160 mm



LA-17
160 mm

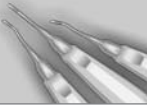

Wurzelheber
Root Elevators
Leve per radici
Elevadores para raíces
Elevateurs à racines

3 mm



LA-20
160 mm

3 mm



LA-21
160 mm

4 mm



LA-22
160 mm

4 mm



LA-23
160 mm

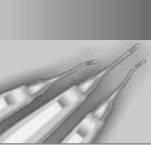

Syndesmotome
Syndesmotomes
Sindesmotomo
Syndesmôtomos
Syndesmotomes



Massiv
Solid
Manico
Pieno
Massif

CHOMPRET
CH-11
150 mm



Massiv
Solid
Manico
Pieno
Massif

CHOMPRET
CH-12
150 mm



Massiv
Solid
Manico
Pieno
Massif

CHOMPRET
CH-13
150 mm



Massiv
Solid
Manico
Pieno
Massif

CHOMPRET
CH-14
145 mm



CHOMPRET
CH-1
165 mm



CHOMPRET
CH-2
165 mm



CHOMPRET
CH-3
165 mm



CHOMPRET
CH-4
160 mm

Zahnreiniger - Periotome
Scalers - Periotomes
Ablatori di tartaro - Periotomi
Limpiadores de sarro - Periotòmos
Detartreurs - Périotomes

MORSE - SCALERS

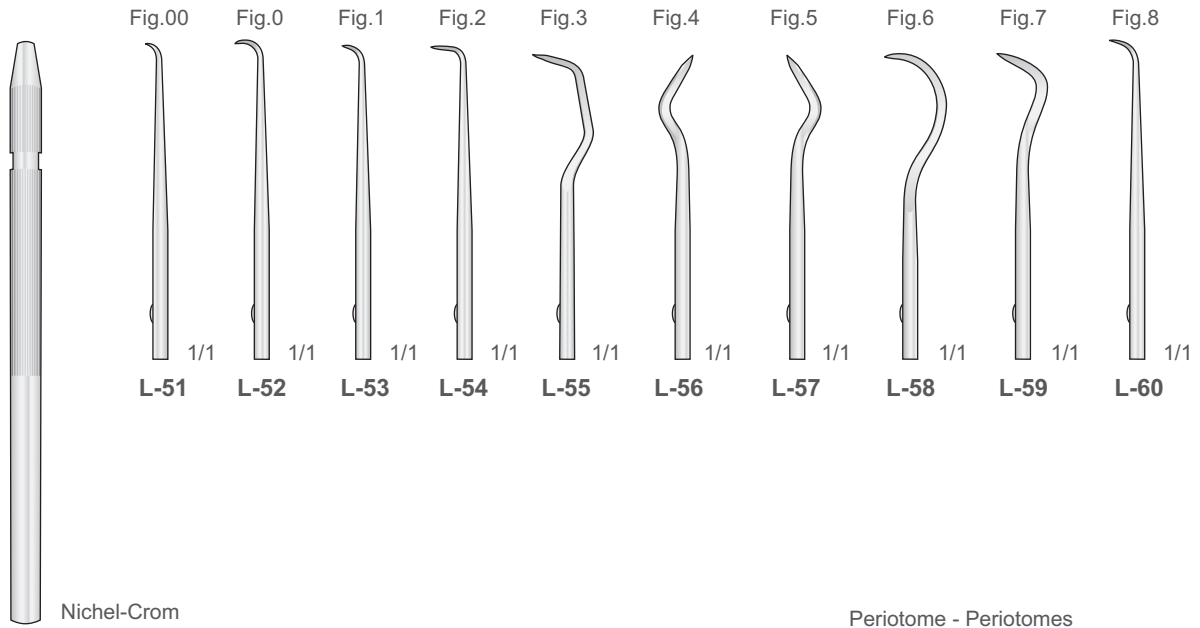

MA-8
125 mm

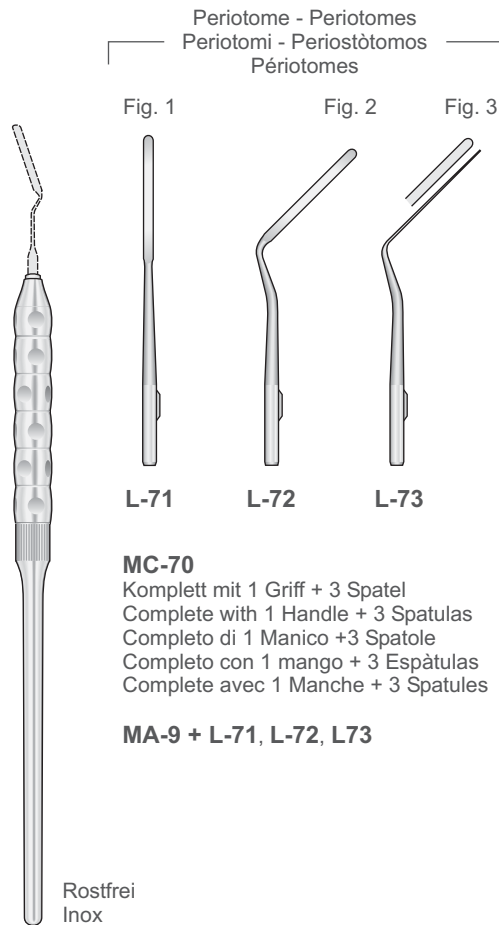

MC-70
Komplett mit 1 Griff + 3 Spatel
Complete with 1 Handle + 3 Spatulas
Completo di 1 Manico + 3 Spatole
Completo con 1 mango + 3 Espátulas
Complete avec 1 Manche + 3 Spatules

MA-9 + L-71, L-72, L73

Ersatz
Insert for replacement
Inserto di ricambio
Puntas de repuesto
Pointes de rechange

Für MA-9
For MA-9
Per MA-9
Para MA-9
Pour MA-9

Periotome - Periotomes
Periotomi - Periotòmos
Périotomes

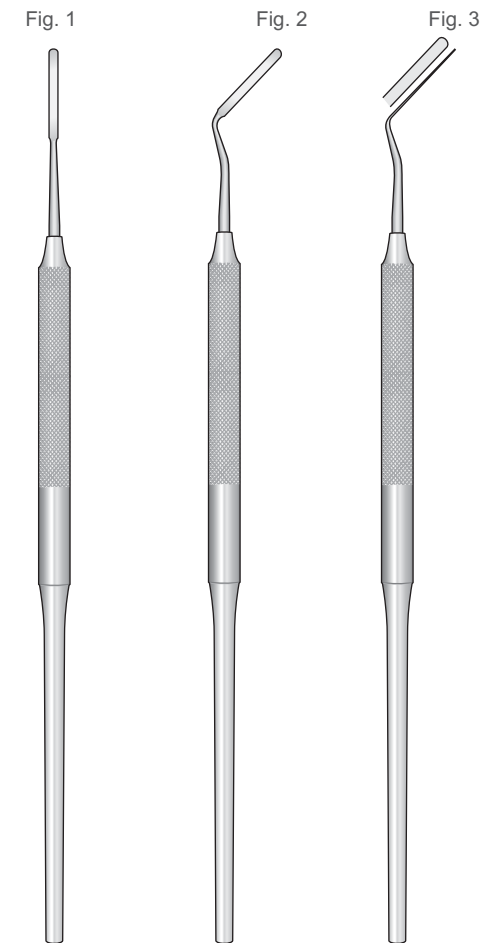

MC-11
160 mm

MC-12
160 mm

MC-13
160 mm

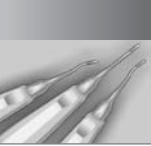

Syndesmotome
Syndesmotomes
Sindesmotomo
Syndesmõtomos
Syndesmotomes

SDM-C

Komplett mit 2 Griffe + 20 Klängen
Complete with 2 Handles + 20 Blades
Completo di 2 Manici + 20 lame
Completo con 2 mangos + 20 hojas
Complete avec 2 Manches + 20 lames

SD-M

Griff
Handle
Manico
Mango
Manche

SDM-9

Komplett mit 2 Griffe + 9 Klängen APICALI
Complete with 2 Handles + 9 Blades APICALI
Completo di 2 Manici + 9 lame APICALI
Completo con 2 mangos + 9 hojas APICALI
Complete avec 2 Manches + 9 lames APICALI

SDM-11

Komplett mit 2 Griffe + 11 Klängen CERVICALI
Complete with 2 Handles + 11 Blades CERVICALI
Completo di 2 Manici + 11 lame CERVICALI
Completo con 2 mangos + 11 hojas CERVICALI
Complete avec 2 Manches + 11 lames CERVICALI



Lame CERVICALI

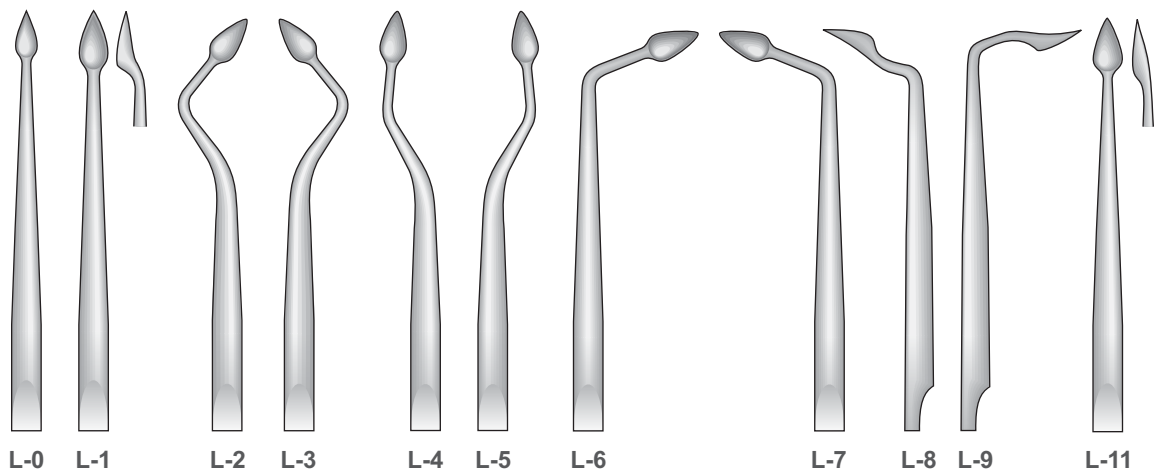

Lame APICALI

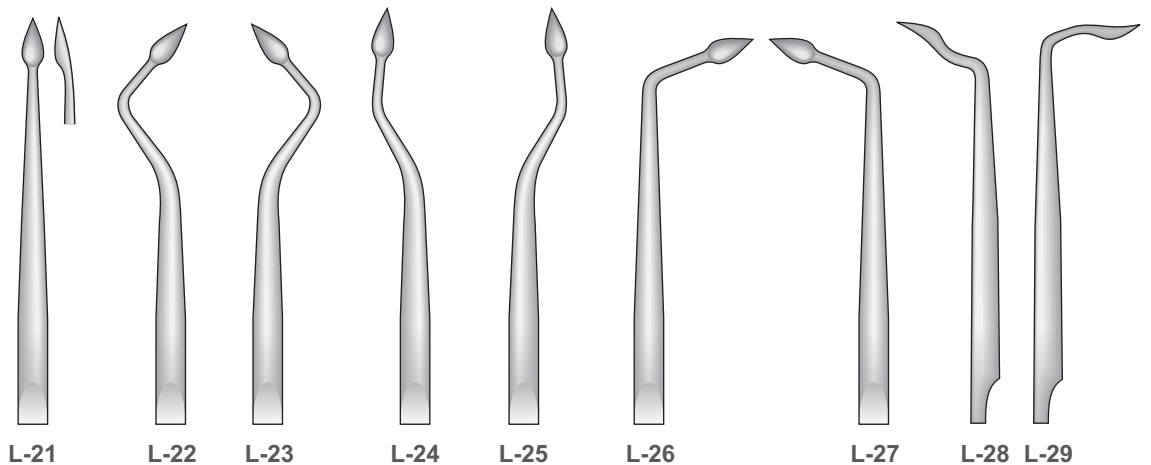

SD-M

.3

Skalpelle
Scalpel Blades
Lame per bisturi
Hojas de bisturí
Lames de bistouris

Zahnärztliche Chirurgie
Dental surgery
Chirurgia dentale
Cirugia dental
Chirurgie dentaire



Skalpellgriffe - Mikro Skalpellklingen
Scalpel Handles - Micro Scalpel Blades
Manici per bisturi - Micro lame per bisturi
Mangos de bisturi - Micro hojas de bisturi
Manches pour bistouris - Micro lames de bistouris



LB-40
Packung 10 Klingen
Package 10 blades
Scatola da 10 lame
Cajita de 10 hojas
Boite de 10 lames

Skalpellgriffe für Mikro-Klingen
Scalpel handles for Micro blades
Manici per micro lame
Mangos de bisturi para micro hojas
Manches de bistouris pour micro lames

Micro-Klingen
Micro blades
Micro lame
Micro hojas
Micro lames

Rasierklingen-Brecker und halter
Razor blade breaker and holder
Manico porta lame
Mango para Hojas de afeitador
Porte lames à rasoir

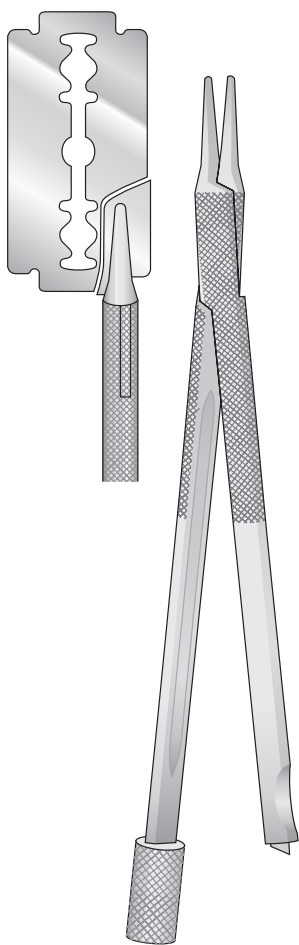

NK-12
120 mm



BB-46
135 mm



BB-48
155 mm



LB-361
Conf. 10 pz.



LB-362
Conf. 10 pz.



LB-363
Conf. 1 pz.



LB-364
Conf. 10 pz.



LB-365
Conf. 10 pz.

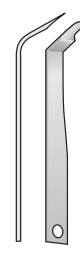

LB-366
Conf. 1 pz.



LB-367
Conf. 10 pz.



LB-368
Conf. 10 pz.



LB-369
Conf. 1 pz.



Skalpelligriffe
Scalpel Handles
Manici porta lame
Mangos de bisturí
Manches de bistouris

Für Mikro-Klingen
For Micro Blades
Per micro lame
Para micro Hojas
Pour Micro-Lame de bistouris

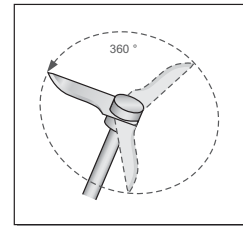

NK-1
100 mm



NK-3
130 mm



NK-2
150 mm

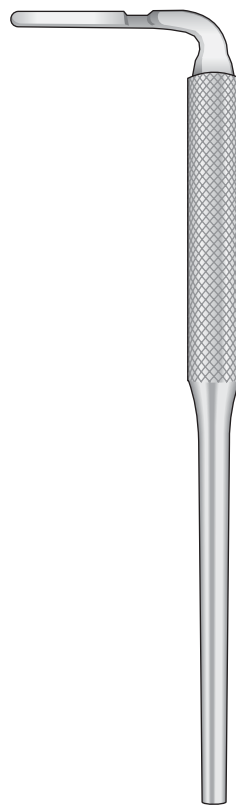

MA-B16
120 mm

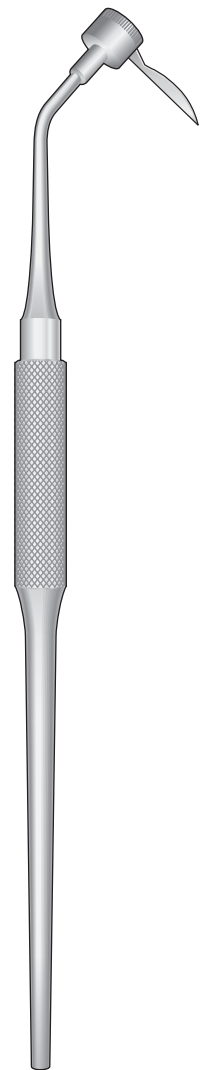

GB-4
165 mm

Skalpell und Skalpellgriffe
Scalpel Blades and Handle
Lame e manici per bisturi
Hojas y mangos de bisturi
Lames et manches de bistouris

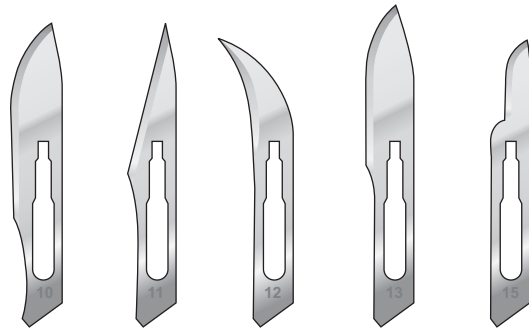

LB-10 Fig. 10 **LB-11** Fig. 11 **LB-12** Fig. 12 **LB-13** Fig. 13 **LB-15** Fig. 15

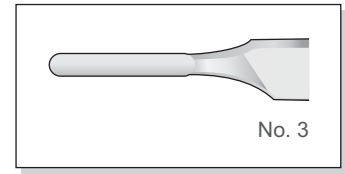

Packungen à 100
Packages of 100 ea
Scatole da 100 pezzi
Cajas de 100 c/u
Boîtes de 100 pièces

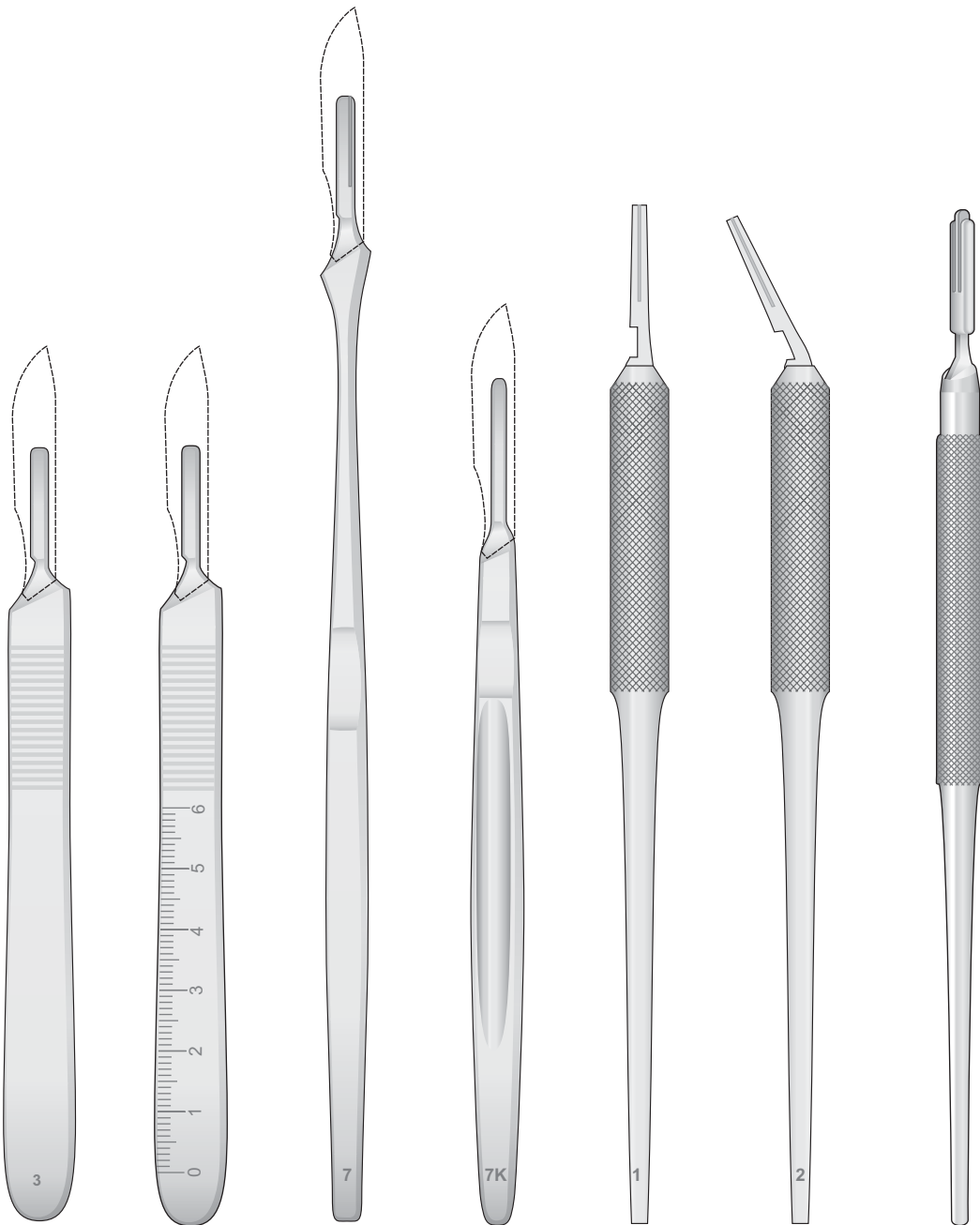

MA-B3 **MA-B3M** Fig. 3M **MA-B7** **MA-B7K** **MA-B1** Fig. 5 **MA-B2** Fig. 5A **MA-B8/MA-B9** 155 mm

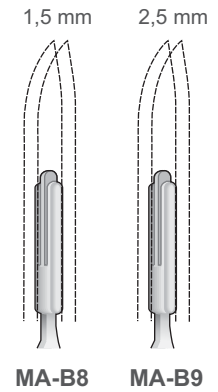

MA-B8 **MA-B9**
Doppelt Skalpellgriff
Scalpel Handle double Blade
Manico per bisturi a doppia lama
Mango de bisturi doble hojas
Manche pour bistouri double-lames



Skalpelle
Scalpel Blades
Lame per bisturi
Hojas de bisturi
Lames de bistouris

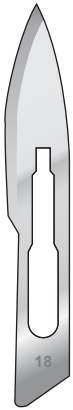

LB-18
Fig. 18



LB-20
Fig. 20



LB-21
Fig. 21



LB-23
Fig. 23

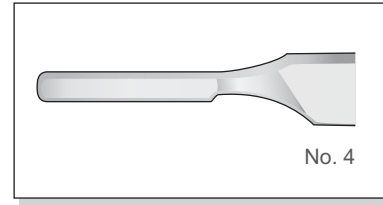

Packungen à 100
Packages of 100 ea
Scatole da 100 pezzi
Cajas de 100 c/u
Boîtes de 100 pièces

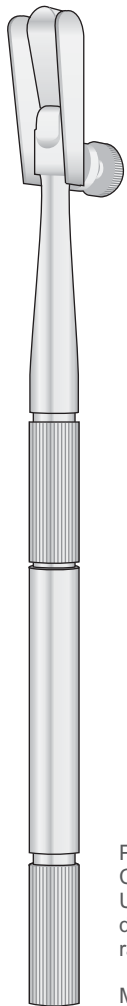

Palatal, Gingival,
Connective Tissue Grafts
Uses standard
double-edged
razor blade

Mucotomo

**PAQUETTE
BLADE HOLDER
GB-2**
160 mm

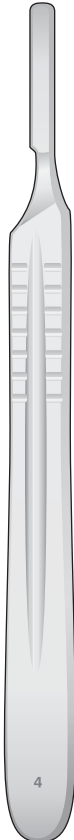

MA-B4
Fig. 4

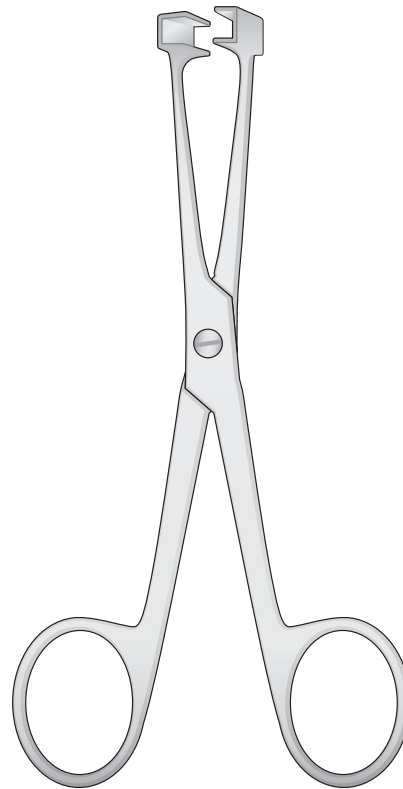

GS-18
135 mm

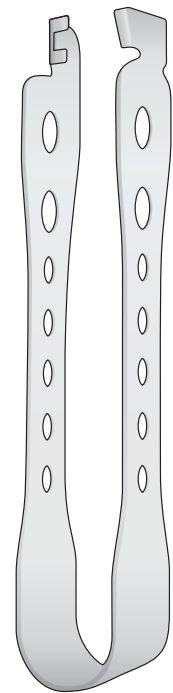

GS-16
115 mm

Klingenentfemer
Scalpel blade removing forceps
Pinze togliilama
Pinza para quitar hojas de bisturís
Pince pour enlever les lames de bistouris



Messer
Knives
Coltelli
Bisturies
Couteau



ZIEGLER
NK-06/NK-10
115 mm

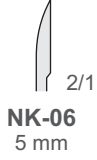

GRAEFE
NK-14/NK-16



GRAEFE
NK-18/NK-20
140 mm

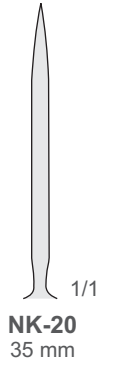
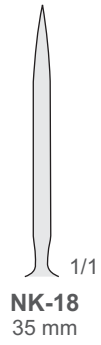

LA FORCE
NK-07
120 mm



ELLIS
NK-09
120 mm



NK-11
125 mm

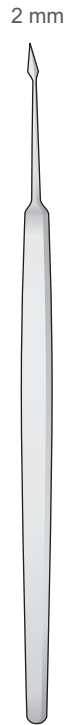

NK-17
125 mm



NK-39
125 mm

2 mm

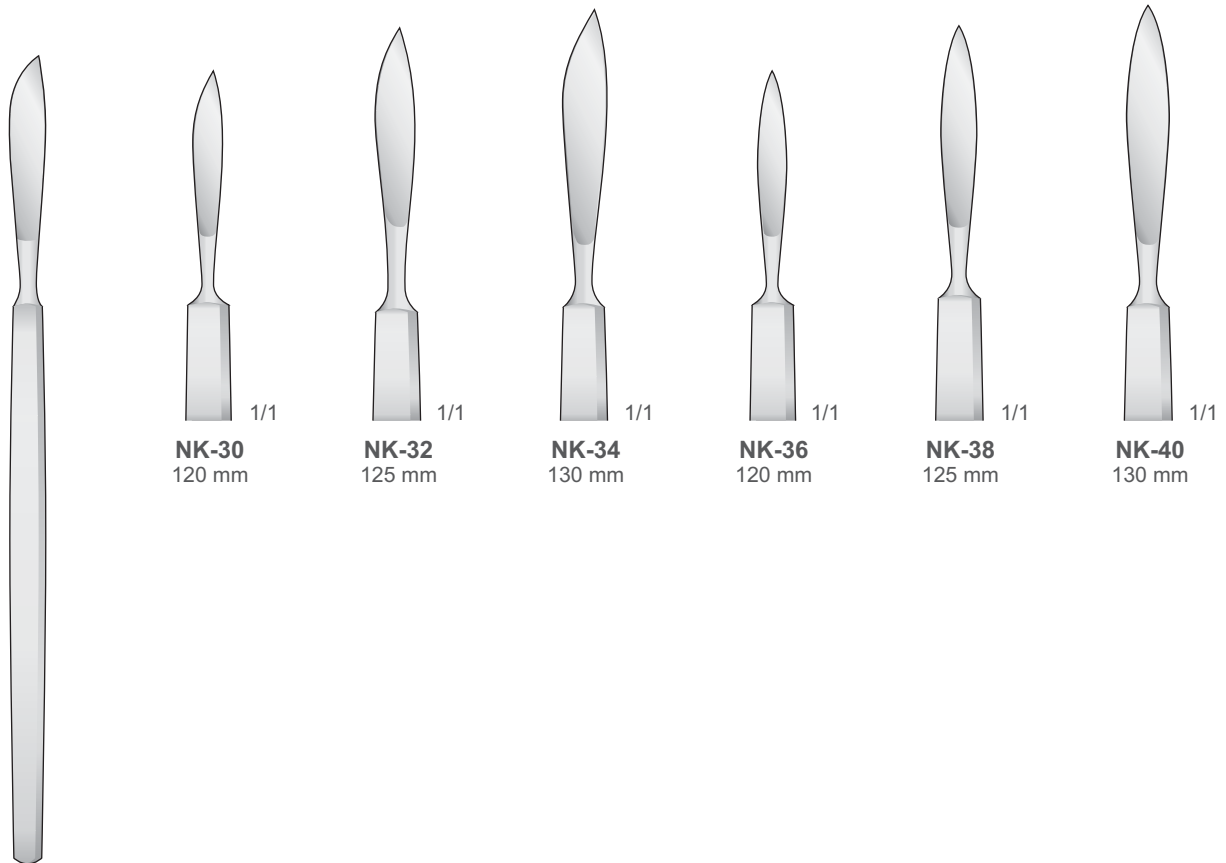
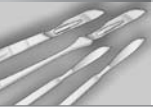

NK-30
120 mm

NK-32
125 mm

NK-34
130 mm

NK-36
120 mm

NK-38
125 mm

NK-40
130 mm

NK-30/NK-40

.4

Scheren
Scissors
Forbici
Tijeras
Ciseaux

Zahnärztliche Chirurgie
Dental surgery
Chirurgia dentale
Cirugia dental
Chirurgie dentaire





Mikro-Scheren
Micro Scissors
Micro Forbici
Micro Tijeras
Micro Ciseaux

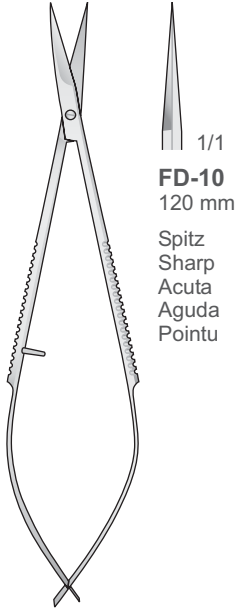

1/1
FD-10
120 mm
Spitz
Sharp
Acuta
Aguda
Pointu

NOYES
FD-10
120 mm

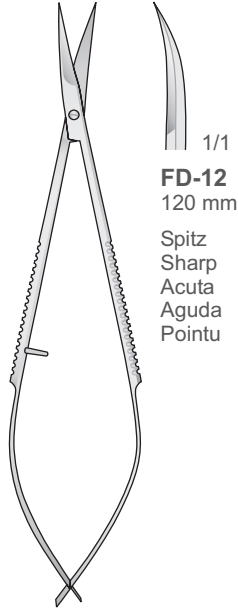

1/1
FD-12
120 mm
Spitz
Sharp
Acuta
Aguda
Pointu

NOYES
FD-12
120 mm

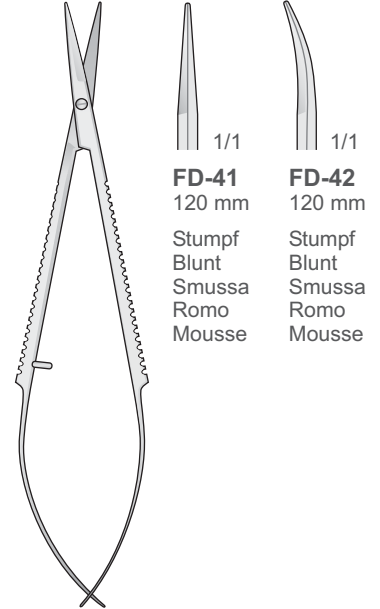

1/1 1/1
FD-41 **FD-42**
120 mm 120 mm
Stumpf
Blunt
Smussa
Romo
Mousse

FD-41/FD-42
120 mm

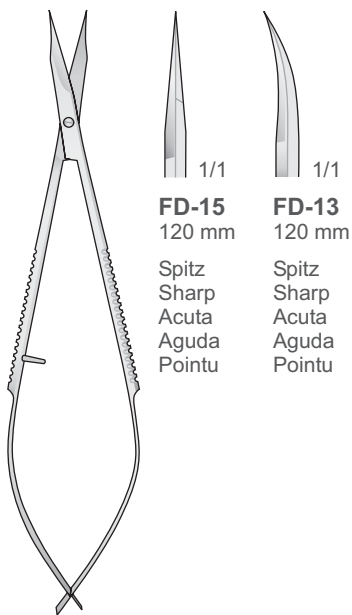

1/1 1/1
FD-15 **FD-13**
120 mm 120 mm
Spitz
Sharp
Acuta
Aguda
Pointu

WESTCOTT
FD-13/FD-15
120 mm

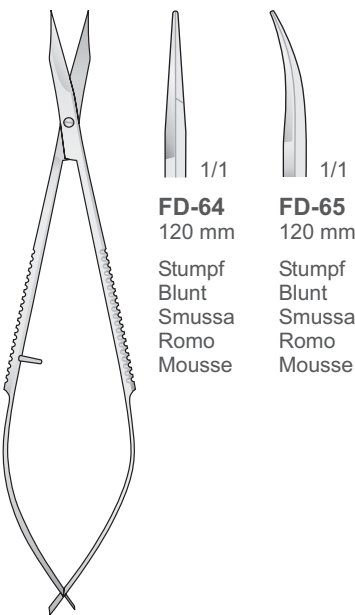

1/1 1/1
FD-64 **FD-65**
120 mm 120 mm
Stumpf
Blunt
Smussa
Romo
Mousse

WESTCOTT
FD-64/FD-65
120 mm

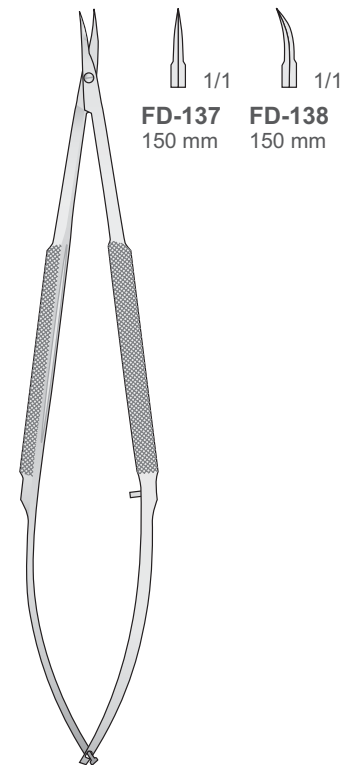

1/1 1/1
FD-137 **FD-138**
150 mm 150 mm

FD-137/FD-138
150 mm



Scheren
Scissors
Forbici
Tijeras
Ciseaux

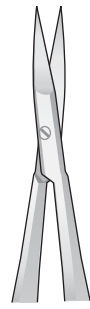
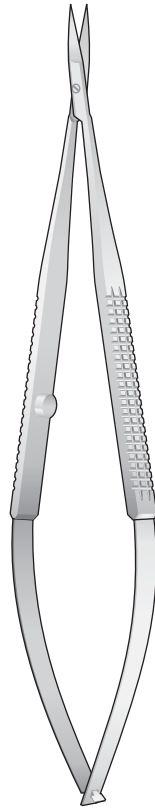

FD-182
160 mm
Spitz
Sharp
Acuta
Aguda
Pointu

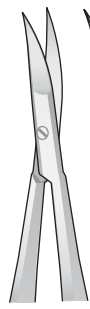

FD-183
160 mm
Spitz
Sharp
Acuta
Aguda
Pointu

1/1

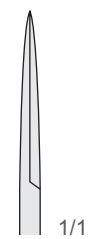
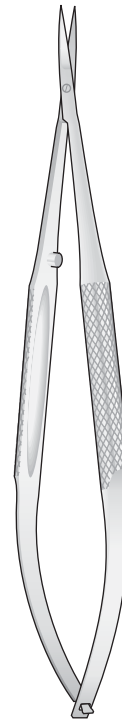

FD-224
145 mm
Spitz
Sharp
Acuta
Aguda
Pointu

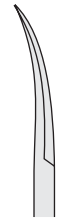

FD-225
145 mm
Spitz
Sharp
Acuta
Aguda
Pointu

1/1

1/1

FD-182/FD-183
160 mm

FD-224/FD-225
145 mm

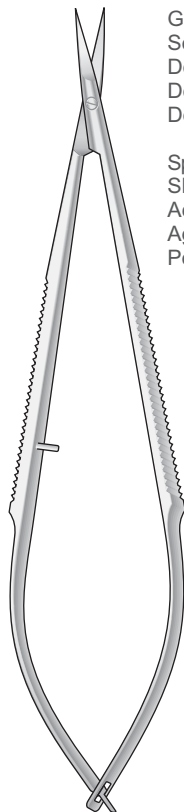

Gezahnt
Serrated
Dentellata
Dentada
Dentelé

Spitz
Sharp
Acuta
Aguda
Pointu

FD-145
160 mm

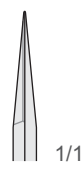
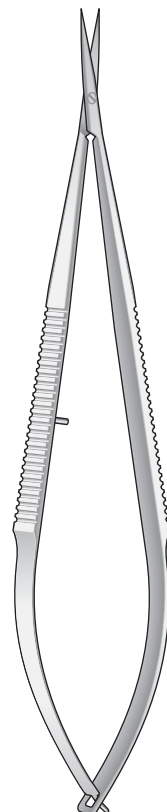

FD-06
160 mm
Spitz
Sharp
Acuta
Aguda
Pointu

1/1

FD-06
160 mm

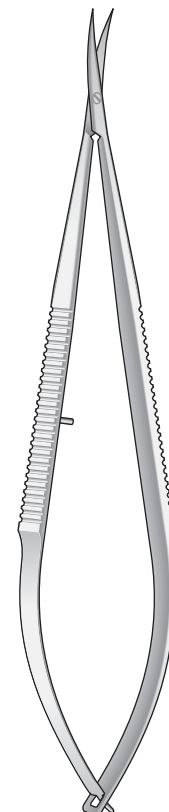

FD-08
160 mm
Spitz
Sharp
Acuta
Aguda
Pointu

1/1

FD-08
160 mm



Scheren
Scissors
Forbici
Tijeras
Ciseaux

Spitz - Sharp
Acuta - Aguda
Pointu

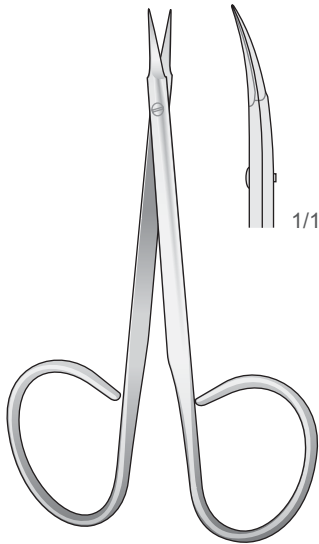

STITCH
FG-216
115 mm

Iris Scheren - Iris scissors
Forbici Iris - Tijeras Iris
Ciseaux Iris

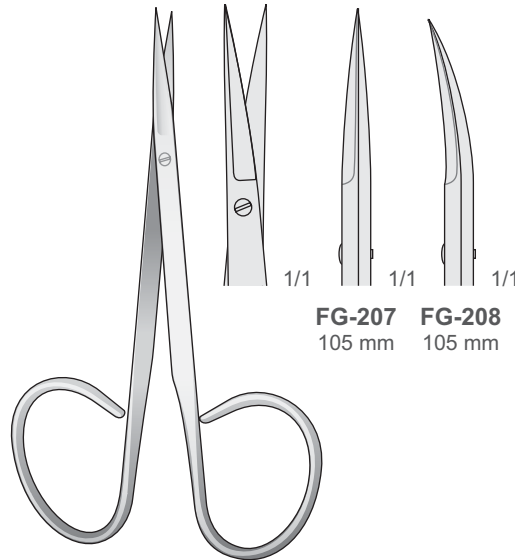

FG-207 **FG-208**
105 mm 105 mm

FG-207/FG-208
105 mm

Stumpf - Blunt
Smussa - Romas
Mousse

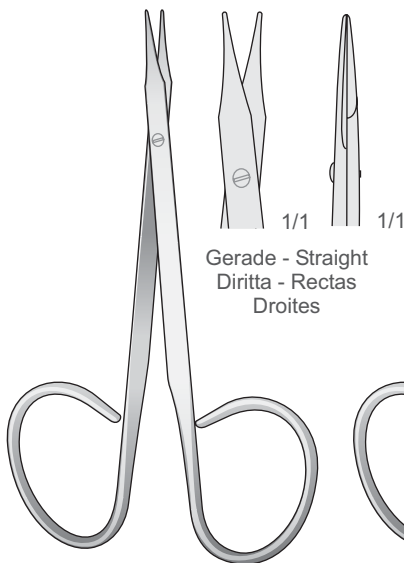

STEVENS
FG-209
100 mm

Stumpf - Blunt
Smussa - Romas
Mousse

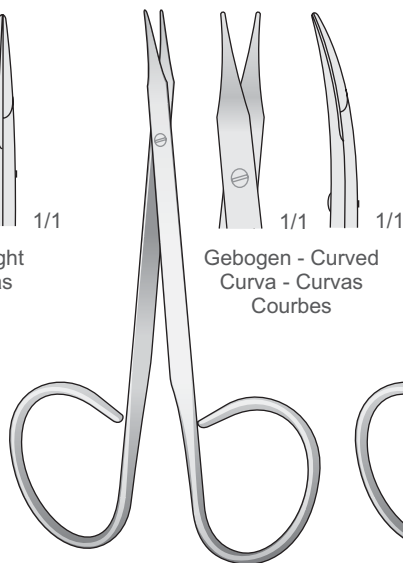

STEVENS
FG-210
100 mm

Spitz - Sharp
Acuta - Aguda
Pointu

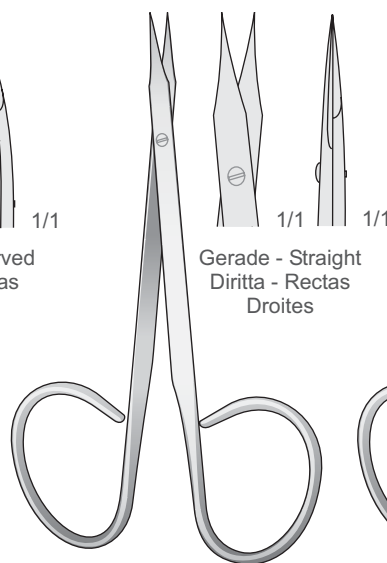

WALTON
FG-211
100 mm

Spitz - Sharp
Acuta - Aguda
Pointu

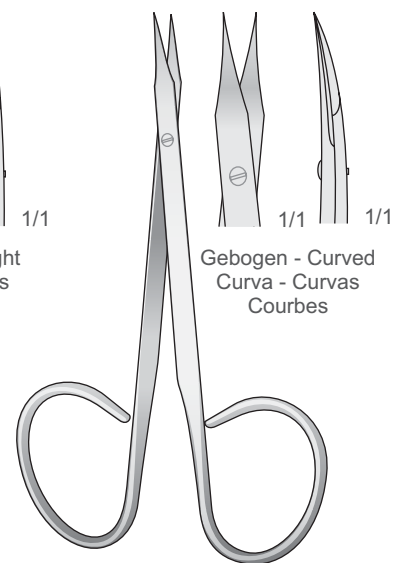

WALTON
FG-212
100 mm

Gerade - Straight
Diritta - Rectas
Droites

Gebogen - Curved
Curva - Curvas
Courbes

Gerade - Straight
Diritta - Rectas
Droites

Gebogen - Curved
Curva - Curvas
Courbes



L = links
left
mancini
izquierdo
gauche

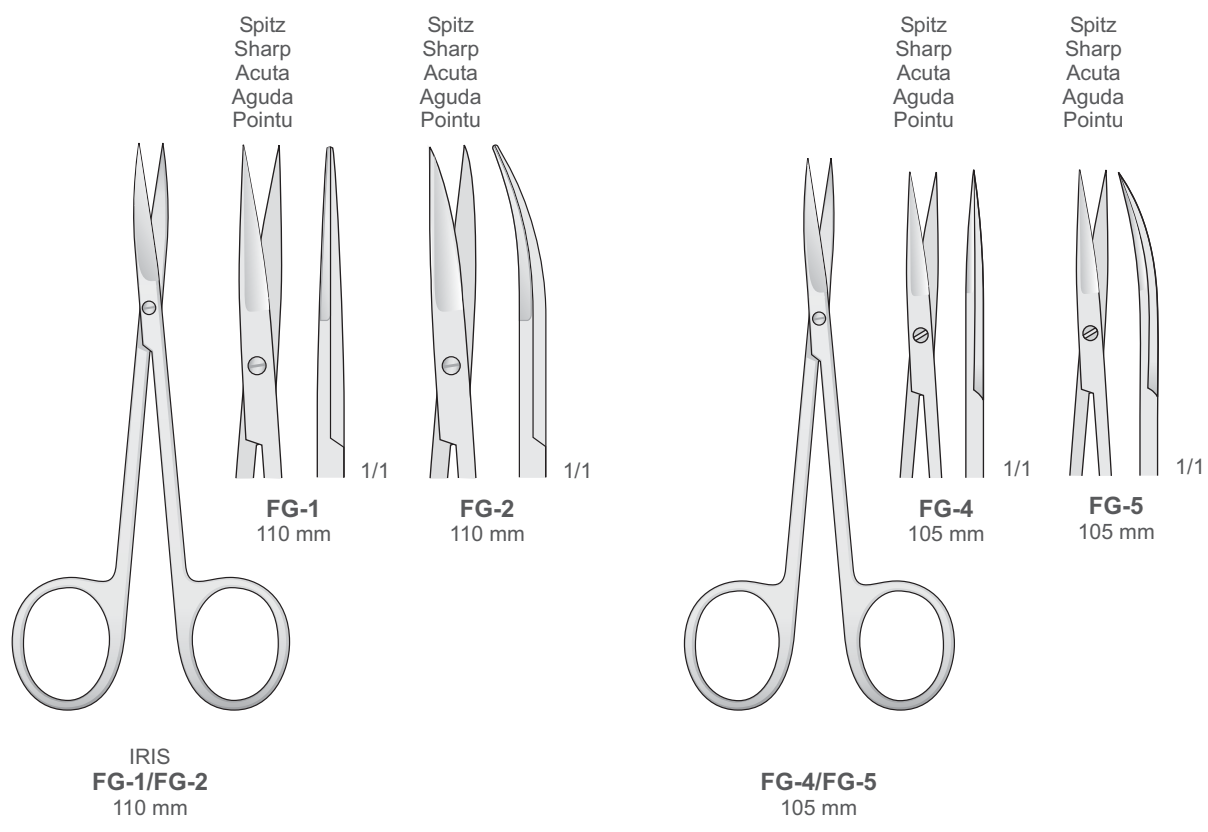
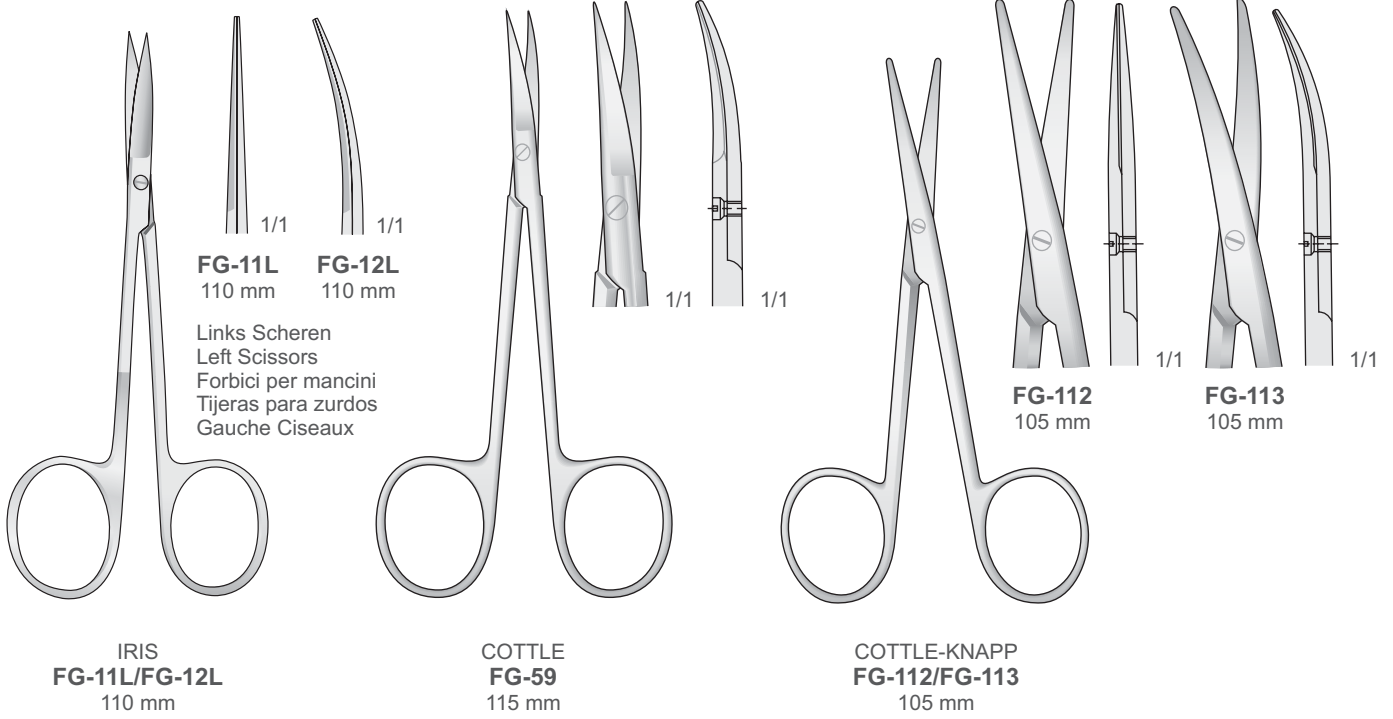



Scheren
Scissors
Forbici
Tijeras
Ciseaux

Gezahnt - Serrated
Dentellata - Dentelé - Dentadas



FG-156
110 mm

FG-157
110 mm

FG-156/FG-157
110 mm

Gezahnt - Serrated
Dentellata - Dentelé - Dentadas

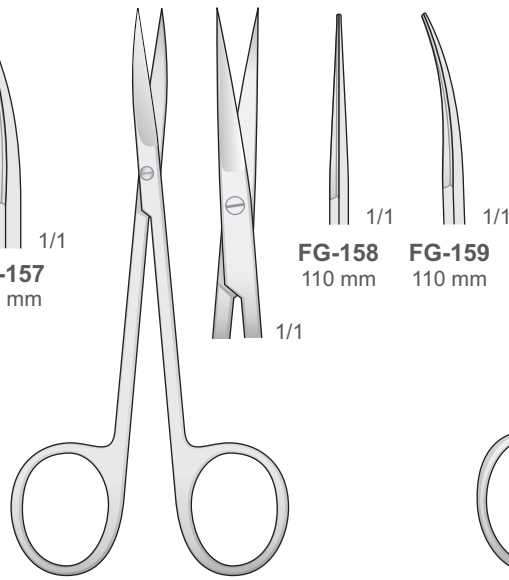

FG-158
110 mm

FG-159
110 mm

FG-158/FG-159
110 mm

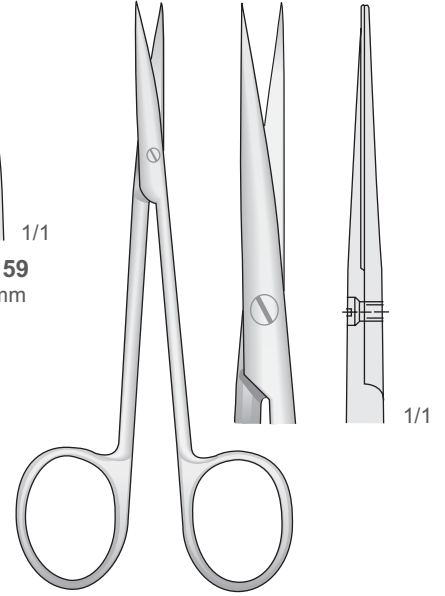

KILNER
FG-58
115 mm

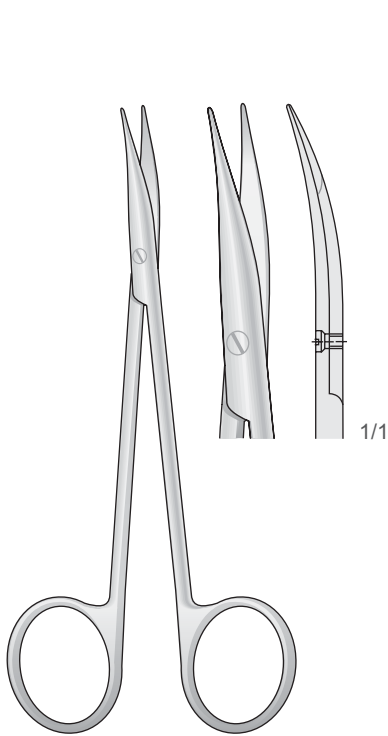

JAMESON-WERBER
FG-123
130 mm

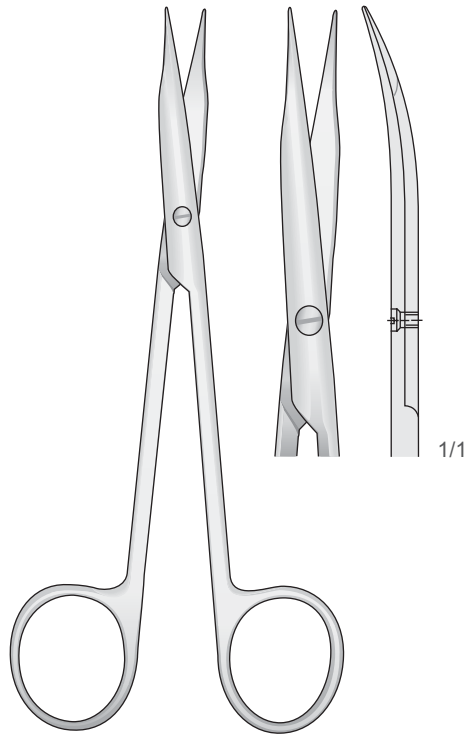

JAMESON
FG-124
145 mm

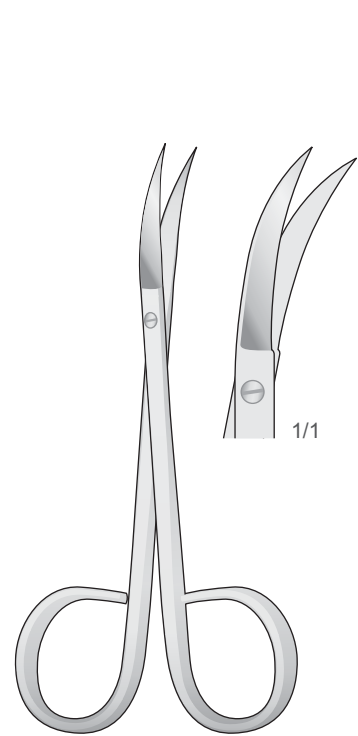

FG-3
115 mm



Scheren
Scissors
Forbici
Tijeras
Ciseaux

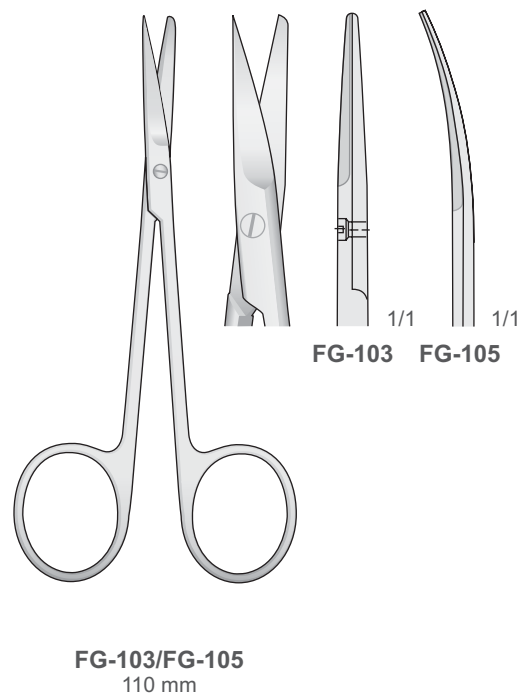
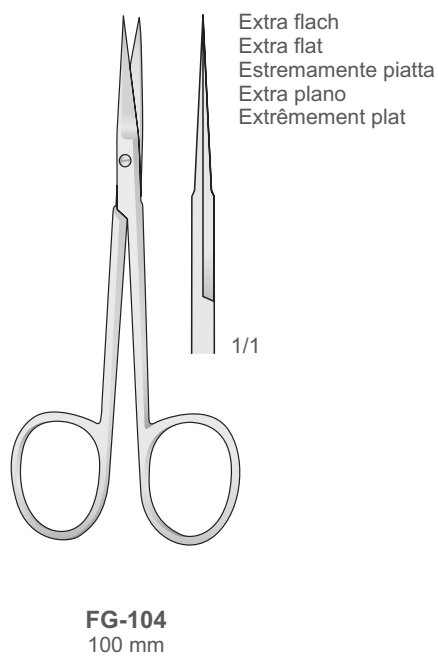
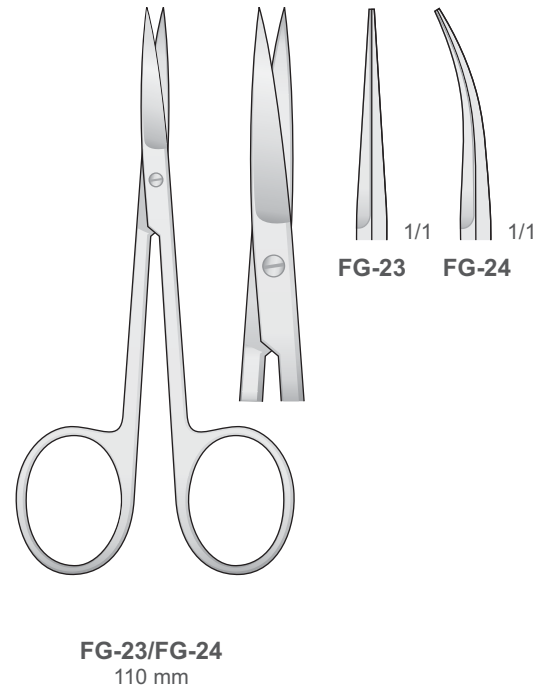
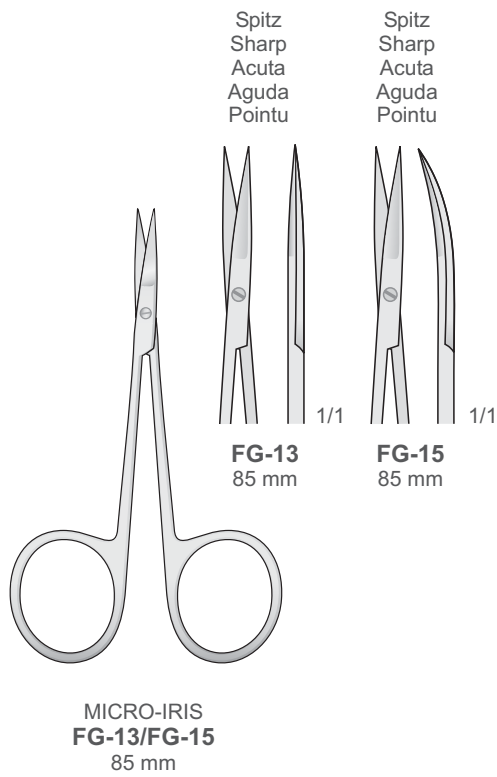



Scheren
Scissors
Forbici
Tijeras
Ciseaux

Spitz - Sharp
Acuta - Agudo
Aigu

Spitz - Sharp
Acuta - Agudo
Aigu



FM-126

FM-127

METZENBAUM
FM-126/FM-127
145 mm

FM-12 **FM-109**

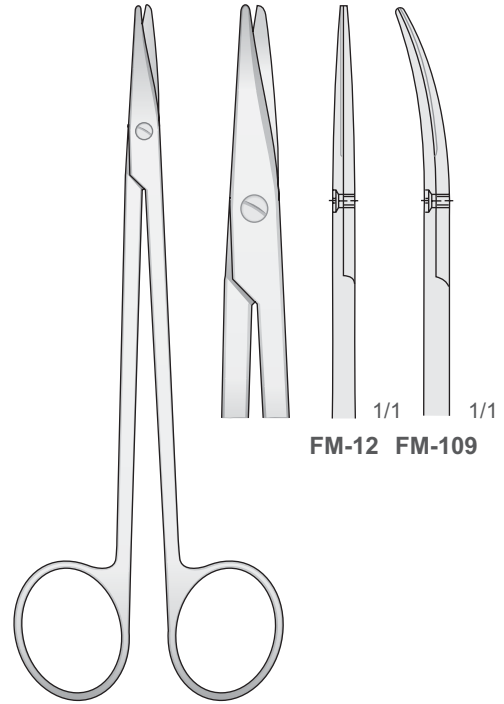

METZENBAUM
FM-12/FM-109
150 mm

1/1
Spitz
Sharp
Acuta
Aguda
Pointu

1/1
Spitz
Sharp
Acuta
Aguda
Pointu

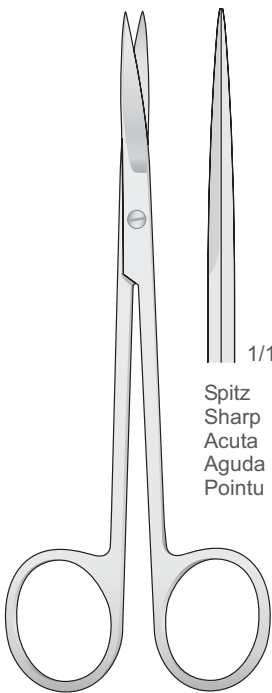

METZENBAUM
FG-28
145 mm

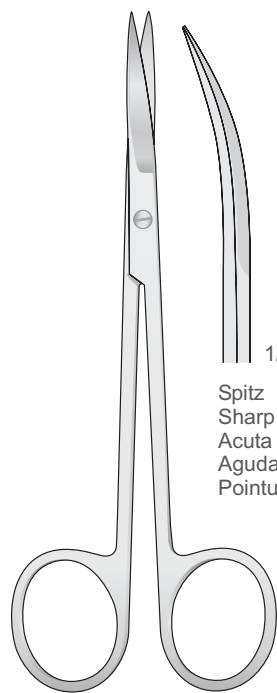

METZENBAUM
FG-14
145 mm

FG-147
150 mm

FG-148
150 mm

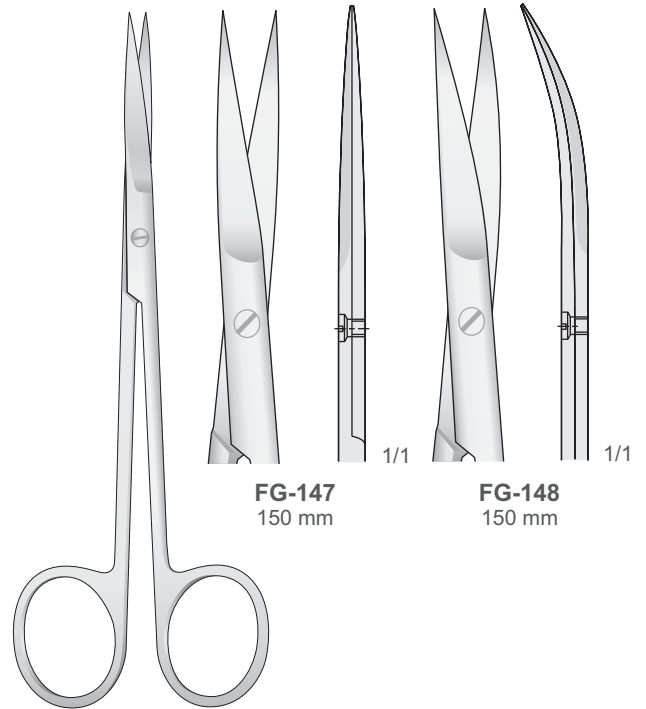

JOSEPH
FG-147/FG-148
150 mm



Scheren
Scissors
Forbici
Tijeras
Ciseaux

Stumpf
Blunt
Smussa
Romas
Mousse

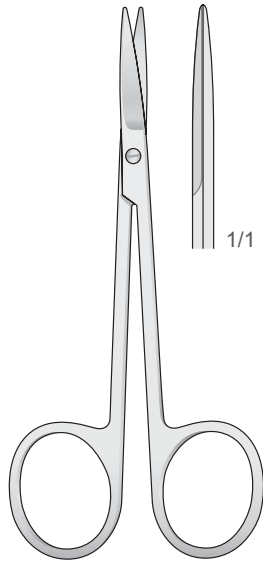

FG-101
110 mm

Stumpf
Blunt
Smussa
Romas
Mousse

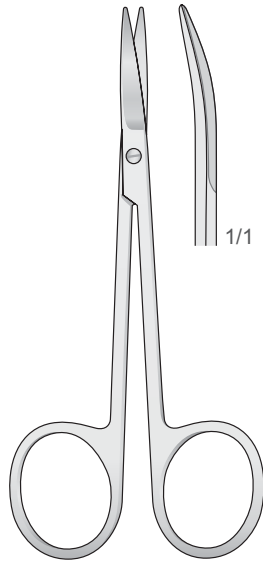

FG-102
110 mm

Stumpf
Blunt
Smussa
Romas
Mousse

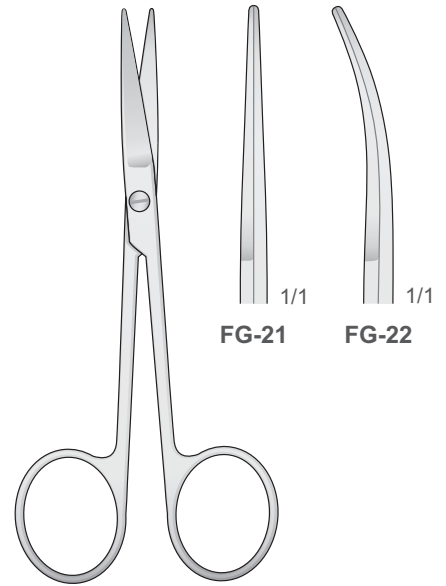

FG-21/FG-22
115 mm

Spitz
Sharp
Acute
Agudas
Pointu

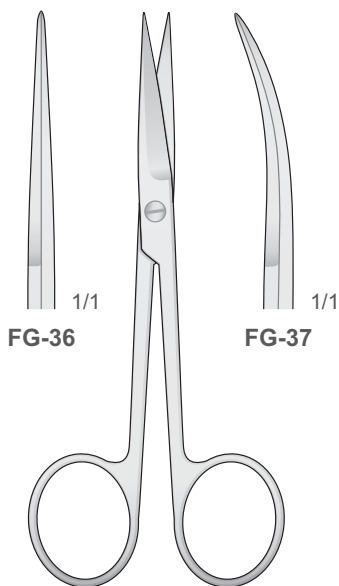

FG-36/FG-37
115 mm

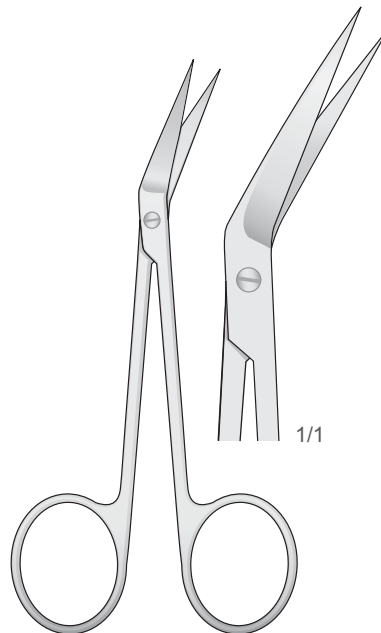

**LOCKLIN
LK-1**
115 mm

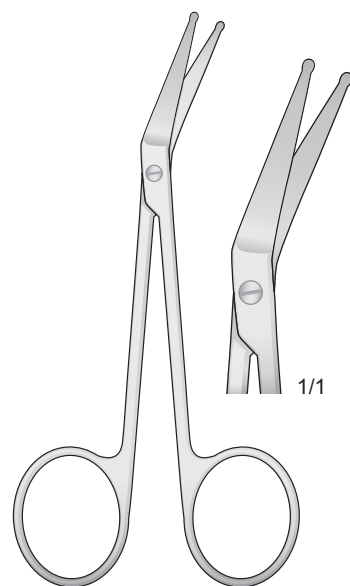

**LOCKLIN MOD.
LK-3**
110 mm



Scheren
Scissors
Forbici
Tijeras
Ciseaux

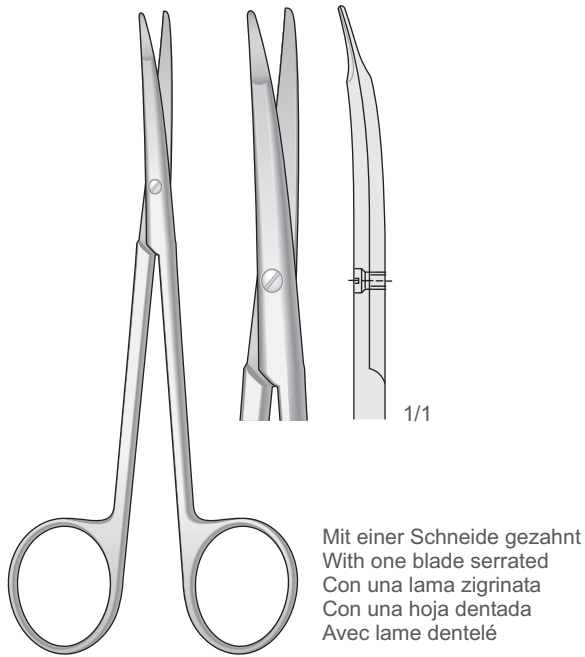

**KILNER
FG-121**
130 mm

Mit einer Schneide gezahnt
With one blade serrated
Con una lama zigrinata
Con una hoja dentada
Avec lame dentelé

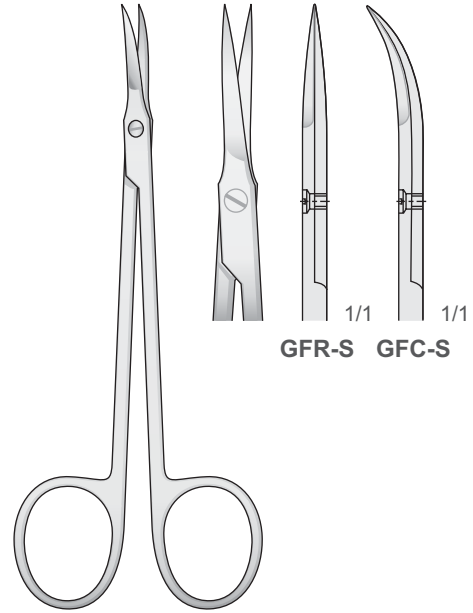

GFR-S/GFC-S
120 mm

Gezahnt - Serrated
Dentellata - Dentadas
Dentelé

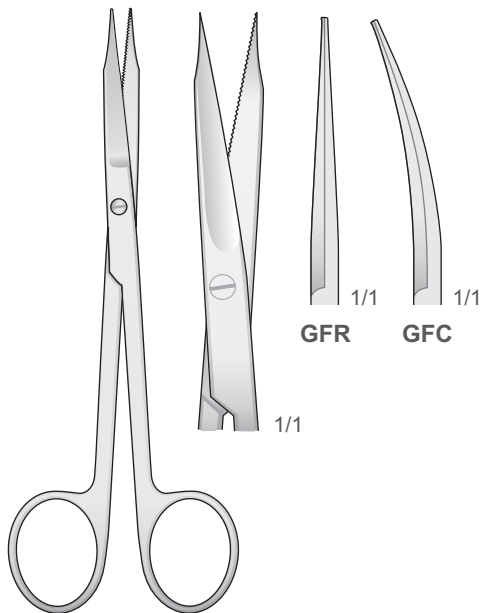

**GOLDMAN-FOX
GFR/GFC**
120 mm

Gezahnt - Serrated
Dentellata - Dentadas
Dentelé

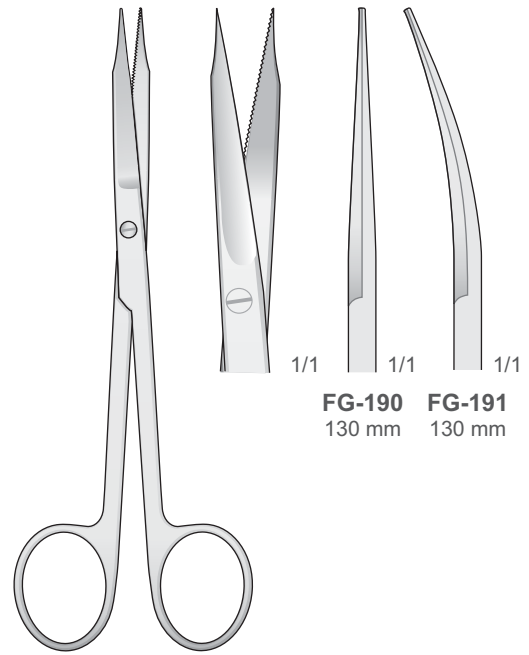

**GOLDMAN-FOX
FG-190/FG-191**
130 mm



Scheren
Scissors
Forbici
Tijeras
Ciseaux

Gezahnt - Serrated
Dentellata - Dentadas
Dentelé

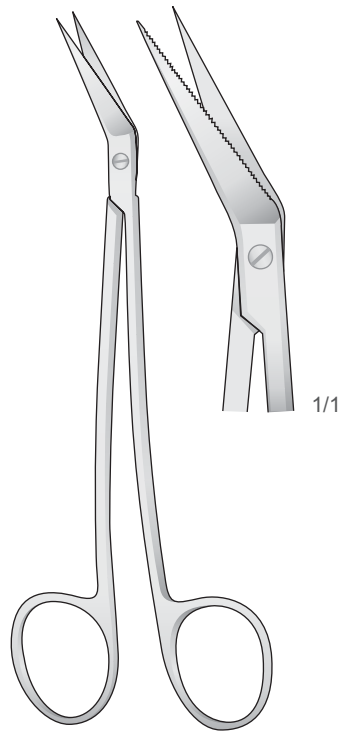

LOCKLIN
LK-2
160 mm

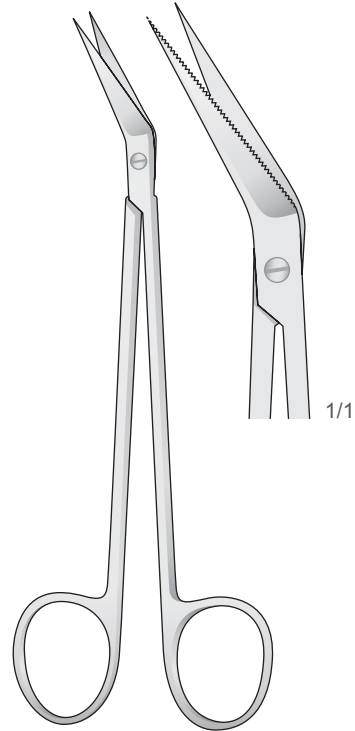

LOCKLIN
LK-4
160 mm

Gezahnt - Serrated
Dentellata - Dentadas
Dentelé

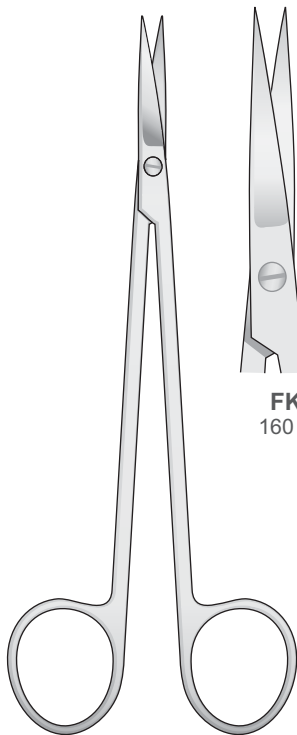

KELLY
FK-1/FK-2
160 mm

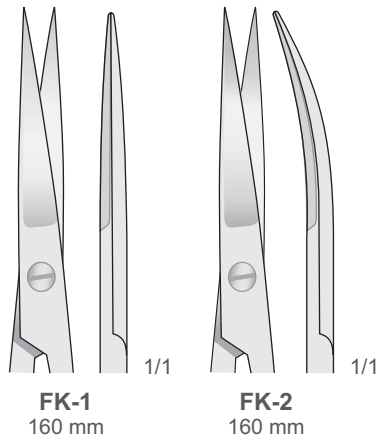

FK-1
160 mm

FK-2
160 mm

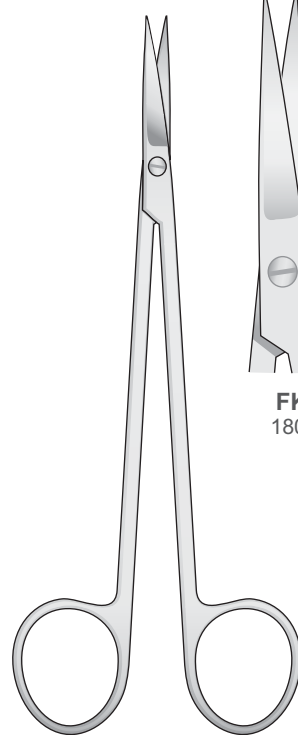

KELLY
FK-87/FK-88
180 mm

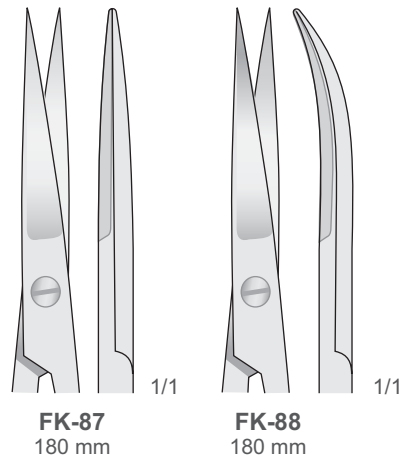

FK-87
180 mm

FK-88
180 mm



Scheren
Scissors
Forbici
Tijeras
Ciseaux

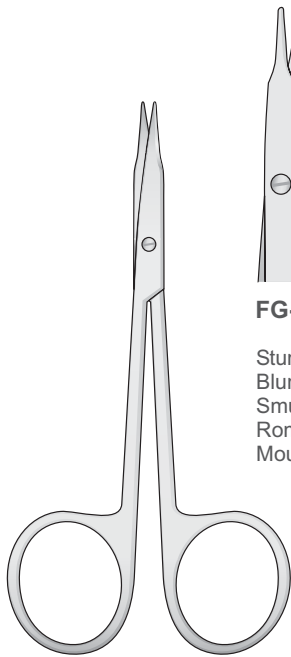

STEVENS
FG-50/FG-53
110 mm

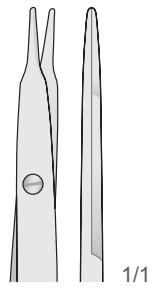

FG-50

Stumpf Gerade
Blunt Straight
Smussa Diritta
Romas Rectas
Mousse Droites

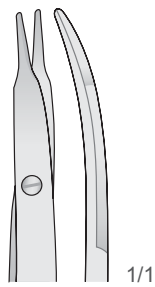

FG-51

Stumpf Gebogen
Blunt Curved
Smussa Curva
Romas Curvas
Mousse Courbes

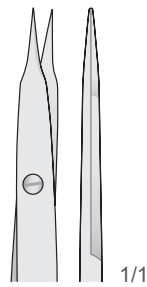

FG-52

Spitz Gerade
Sharp Straight
Acuta Diritta
Agudas Rectas
Pointu Droites

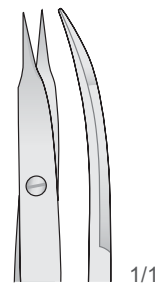

FG-53

Spitz Gebogen
Sharp Curved
Acuta Curva
Agudas Curvas
Pointu Courbes

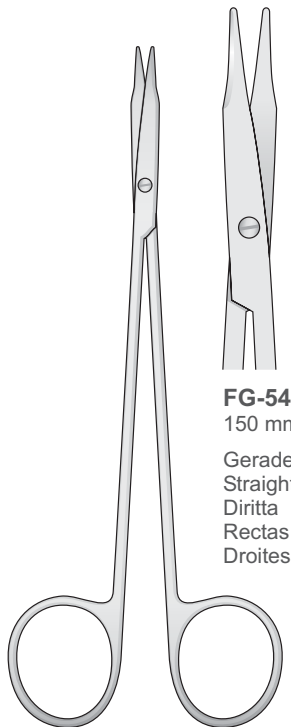

REYNOLDS
FG-54/FG-55

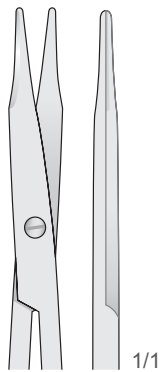

FG-54
150 mm

Gerade
Straight
Diritta
Rectas
Droites

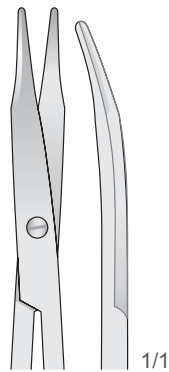

FG-55
150 mm

Gebogen
Curved
Curva
Curvas
Courbes

Stumpf
Blunt
Smussa
Romas
Mousse

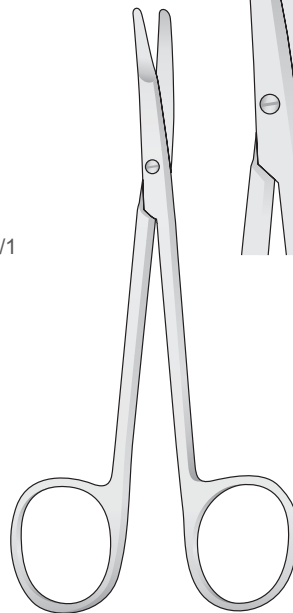

KILNER
FG-19C/FG-67

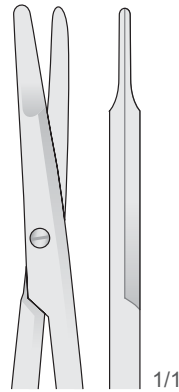

FG-66
120 mm

Gerade
Straight
Diritta
Rectas
Droites

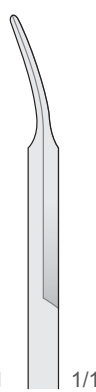

FG-67
120 mm

Gebogen
Curved
Curva
Curvas
Courbes

Stumpf
Blunt
Smussa
Romas
Mousse

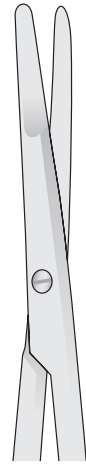

FG-19R
135 mm

Gerade
Straight
Diritta
Rectas
Droites

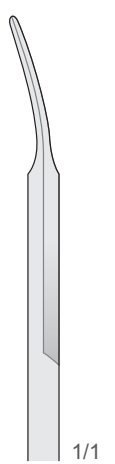

FG-19C
135 mm

Gebogen
Curved
Curva
Curvas
Courbes



Scheren
Scissors
Forbici
Tijeras
Ciseaux

Gezahnt - Serrated
Dentellata - Dentadas
Dentelé

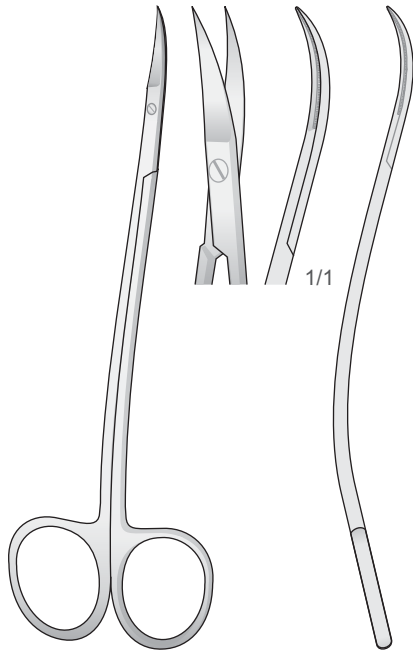

LA GRANGE
LG-1
115 mm

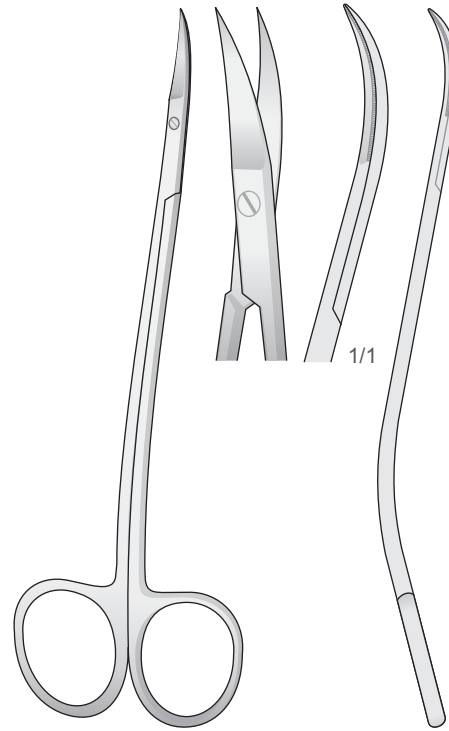

LA GRANGE
LG-6
155 mm

Gezahnt - Serrated
Dentellata - Dentadas
Dentelé

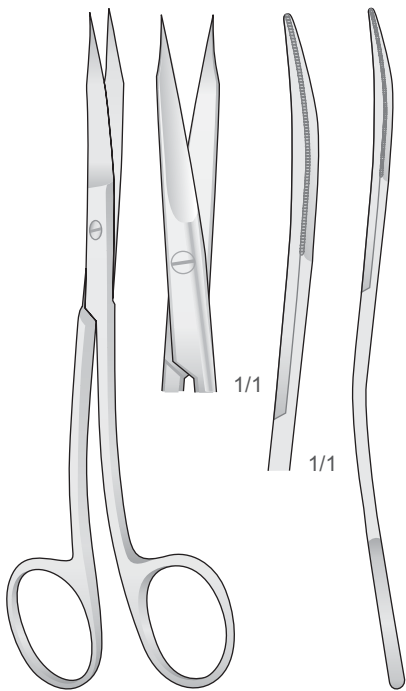

GOLDMAN-FOX S FORM
GFS
130 mm

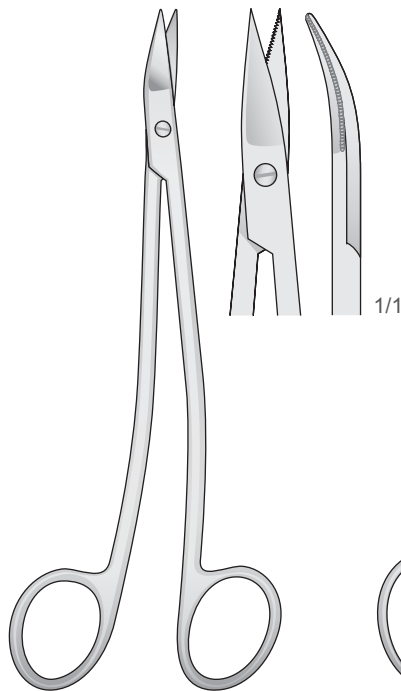

NEUMANN
FG-20
130 mm

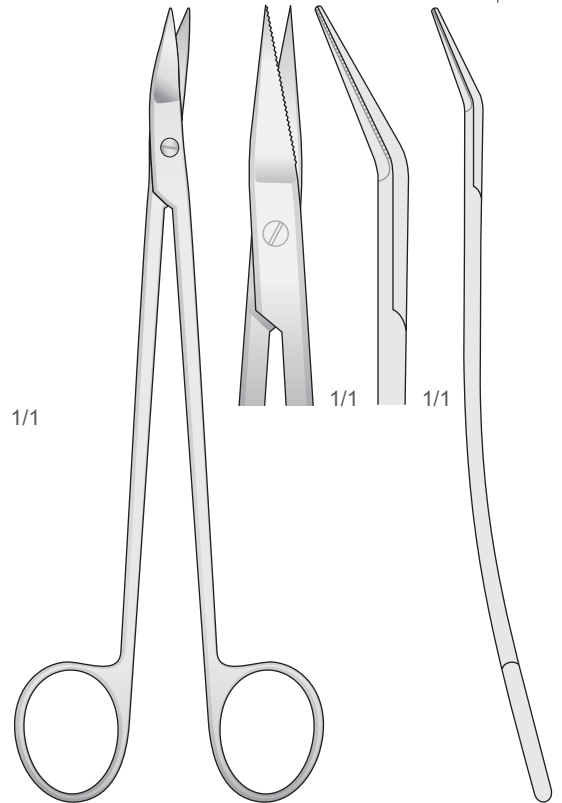

DEAN
DEAN
180 mm



Scheren
Scissors
Forbici
Tijeras
Ciseaux

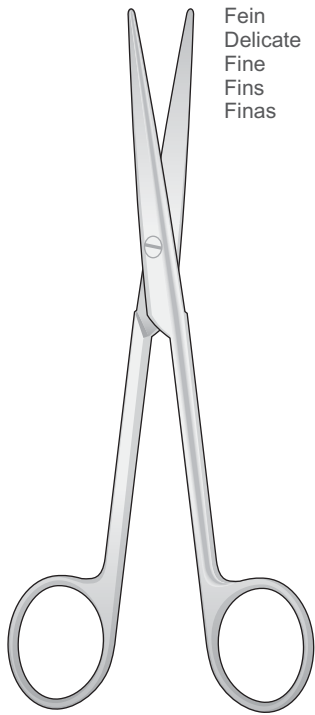

Fein
Delicate
Fine
Fins
Finas

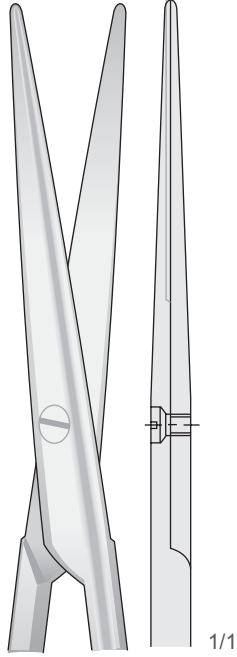

FM-180

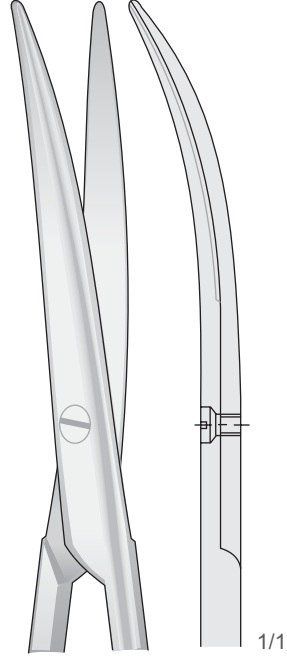

FM-181

LEXER
FM-180/FM-181
165 mm

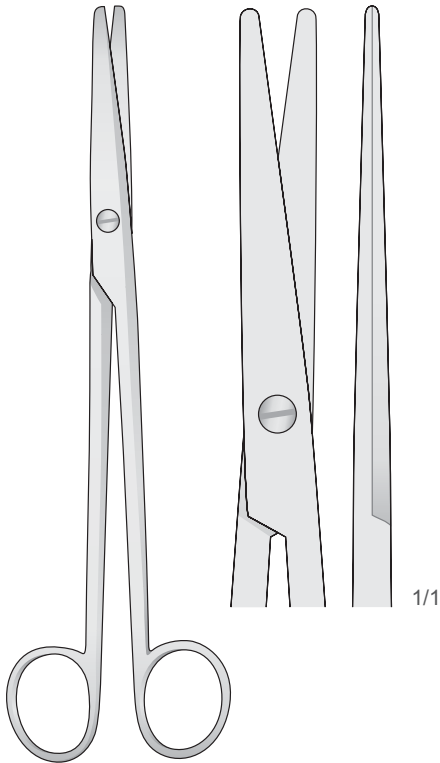

MAYO-STILLE
FM-80
160 mm

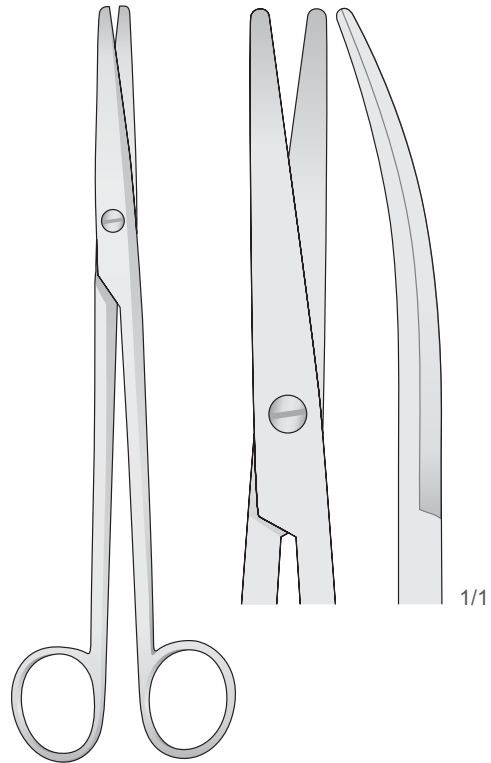

MAYO-LEXER
FM-79
165 mm



Scheren
Scissors
Forbici
Tijeras
Ciseaux

Stumpf
Blunt
Smusse
Romas
Mousses

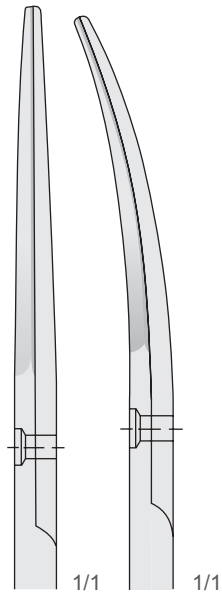
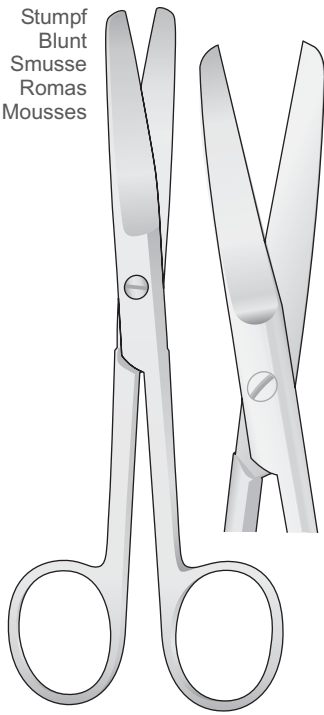

FM-9 145 mm
FM-10 145 mm

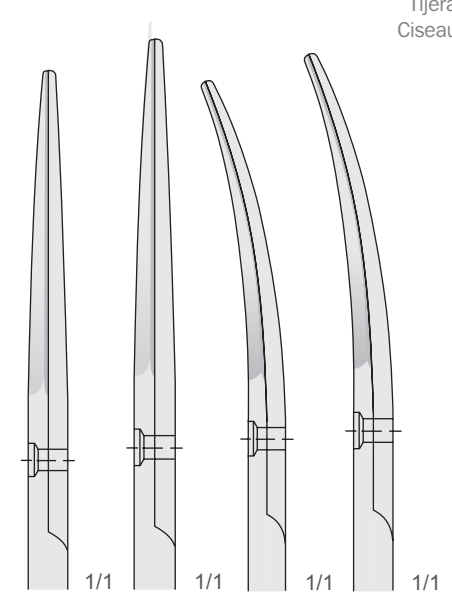
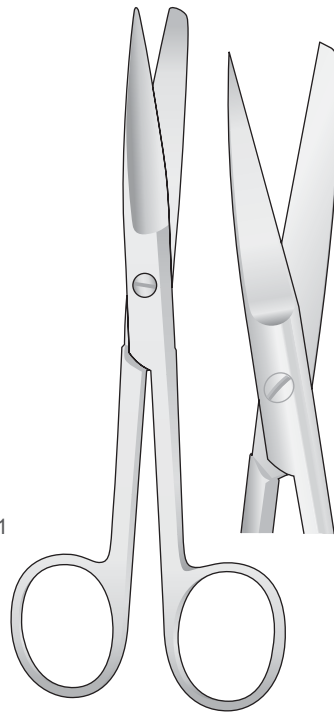

FM-49 115 mm
FM-27 130 mm
FM-63 115 mm
FM-28 130 mm

FM-9/FM-10
145 mm

FM-27/FM-63

Stumpf
Blunt
Smusse
Romas
Mousses

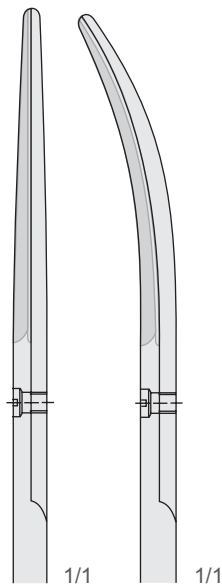
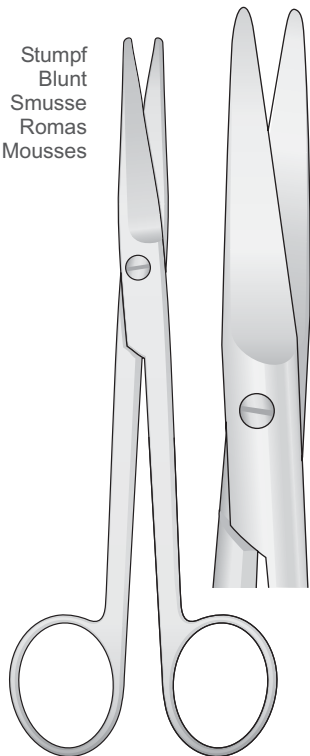

FM-5 140 mm
FM-6 140 mm

Spitz
Sharp
Acute
Agudo
Pointu

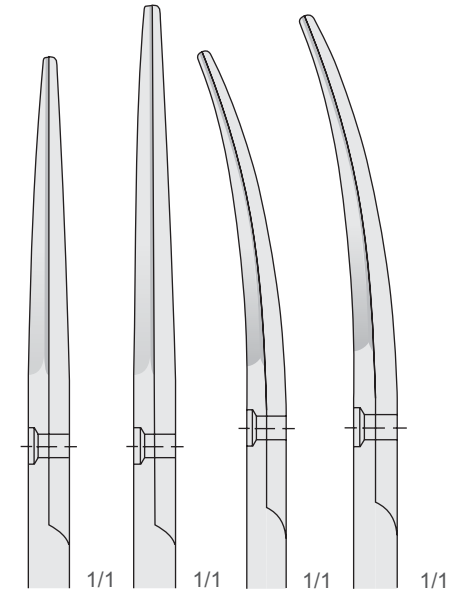
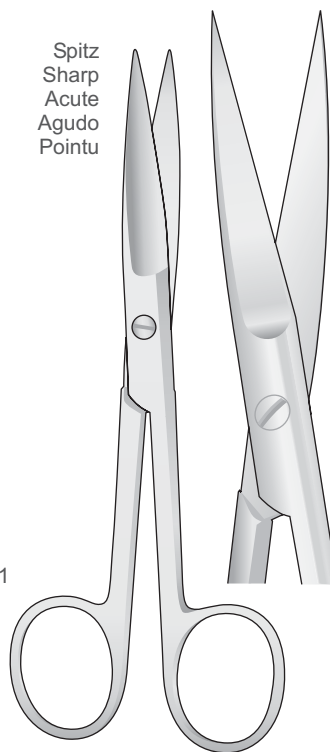

FM-41 130 mm
FM-7 145 mm
FM-42 130 mm
FM-8 145 mm

MAYO
FM-5/FM-6
140 mm

FM-7/FM-42



Scheren
Scissors
Forbici
Tijeras
Ciseaux

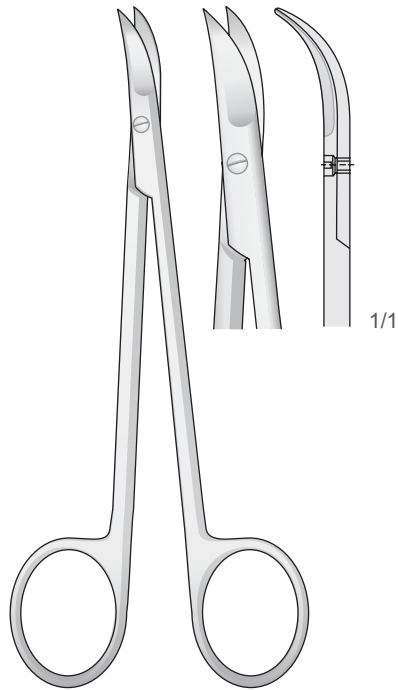

CHADWICK
FG-39
115 mm

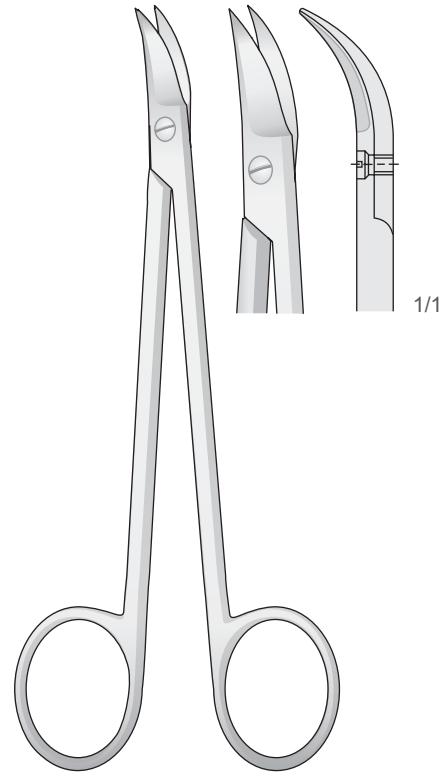

QUINBY
FG-38
130 mm

Super Cut

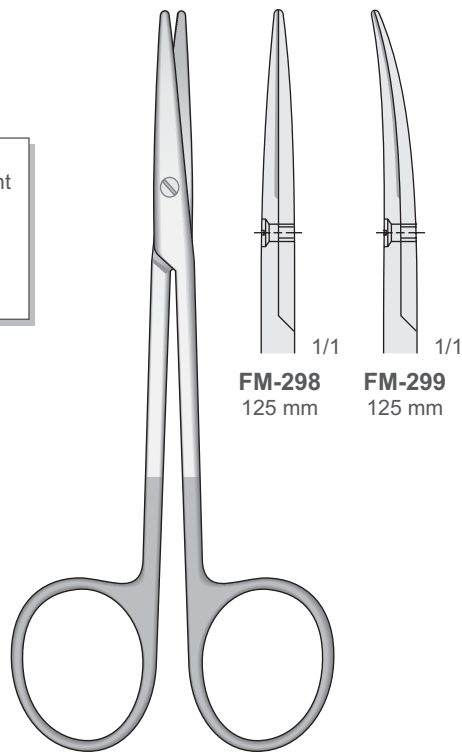

FM-298 125 mm
FM-299 125 mm

Super Cut

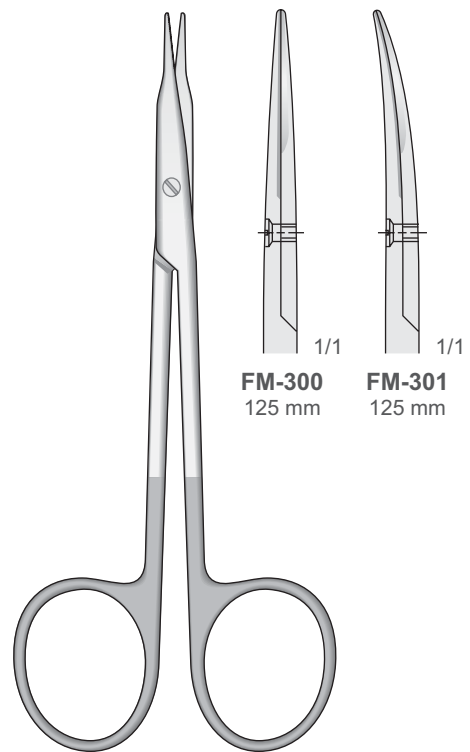

FM-300 125 mm
FM-301 125 mm

Mit einer Schneide gezahnt
With one blade serrated
Con una lama dentellata
Con una hoja dentada
Avec une lame dentelé

METZENBAUM
FM-298/FM-299
125 mm

STEVENS
FM-300/FM-301
125 mm



Scheren
Scissors
Forbici
Tijeras
Ciseaux

Fein
Delicate
Fine
Finas
Fins

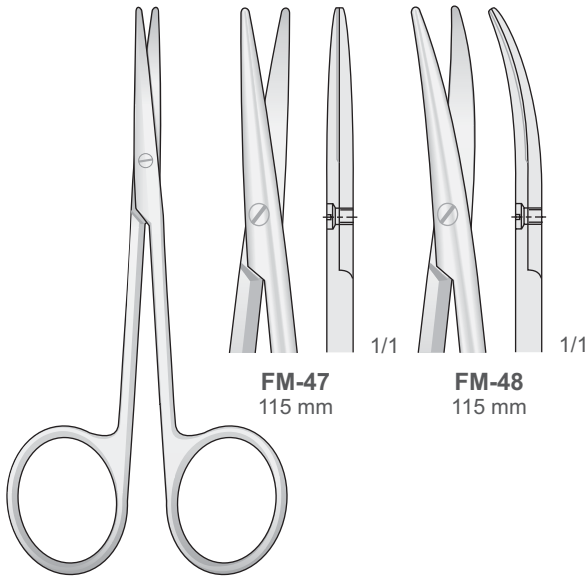

FM-47
115 mm

FM-48
115 mm

BABY - METZENBAUM
FM-47/FM-48
115 mm

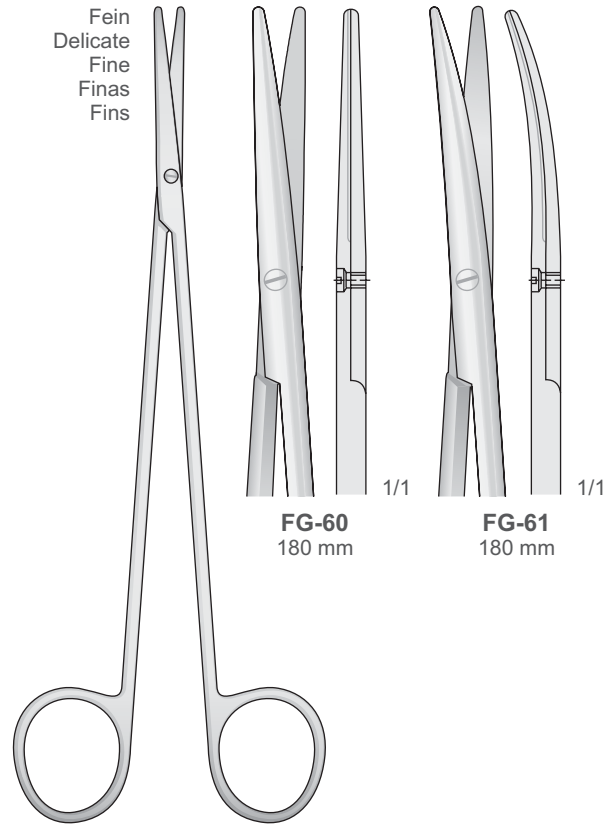

FG-60
180 mm

FG-61
180 mm

TOENNIS-ADSON
FG-60/FG-61
180 mm

Präparierscheren - Dissecting Scissors
Forbici per dissezione - Tijeras para preparaciones - Ciseaux à dissection

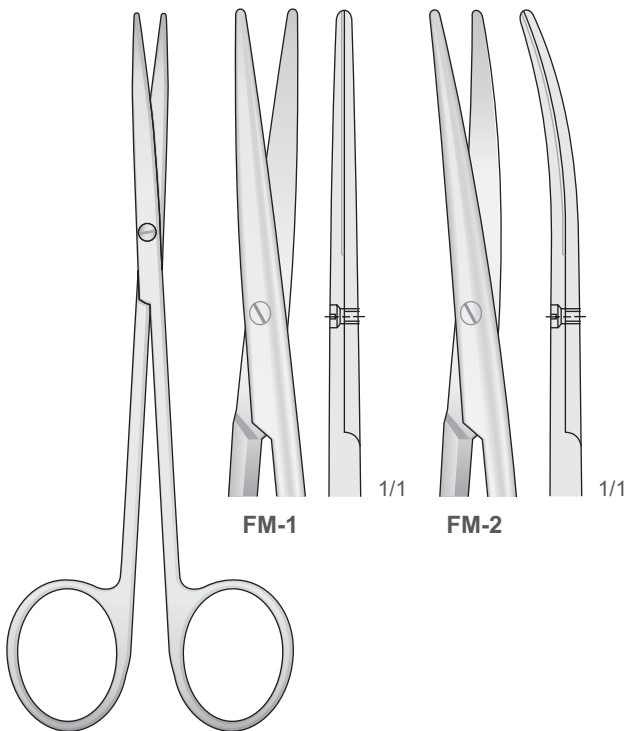

FM-1

FM-2

METZENBAUM
FM-1/FM-2
145 mm

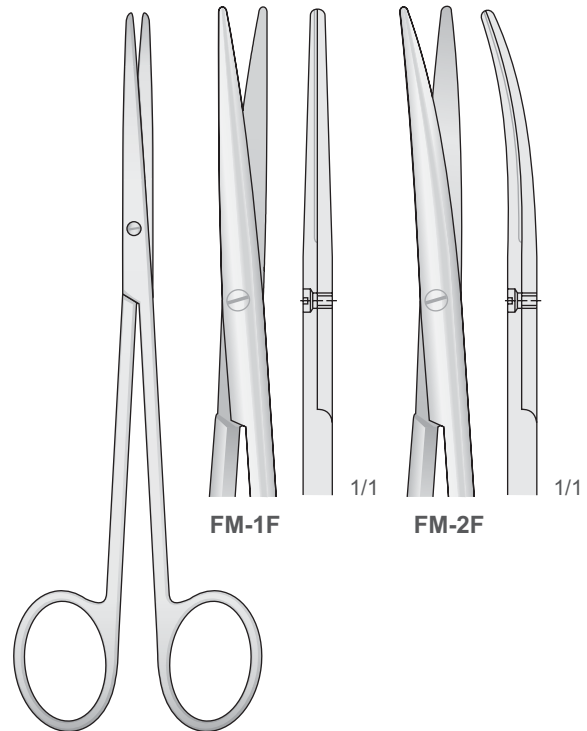

FM-1F

FM-2F

METZENBAUM-FINO
FM-1F/FM-2F
145 mm



Scheren
Scissors
Forbici
Tijeras
Ciseaux

Mit Hartmetalleinsätzen - Tungsten-carbide scissors
Con punta al carburo di tungsteno - Tijeras de tungsteno - Avec plaquettes en carbure de tungstène

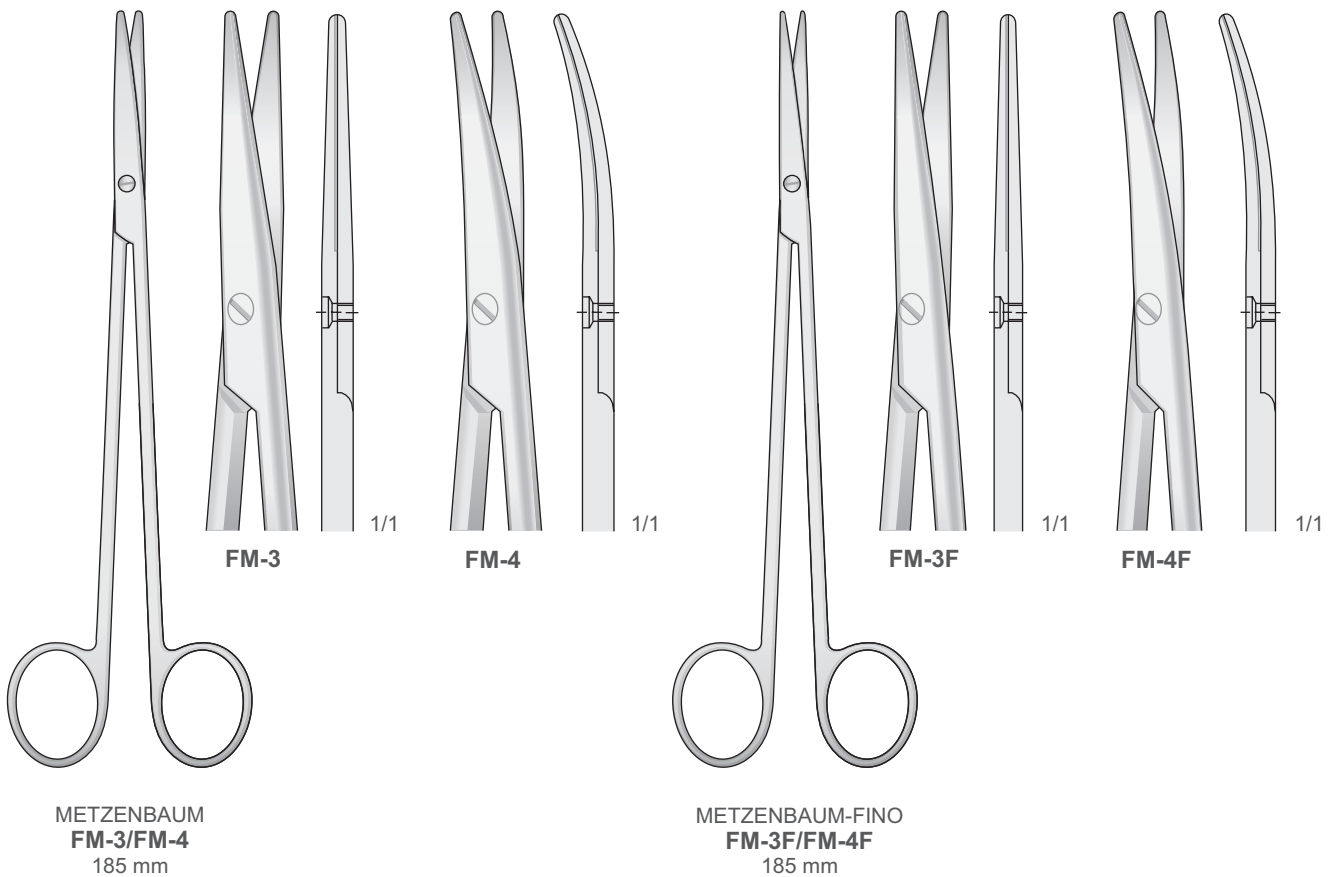
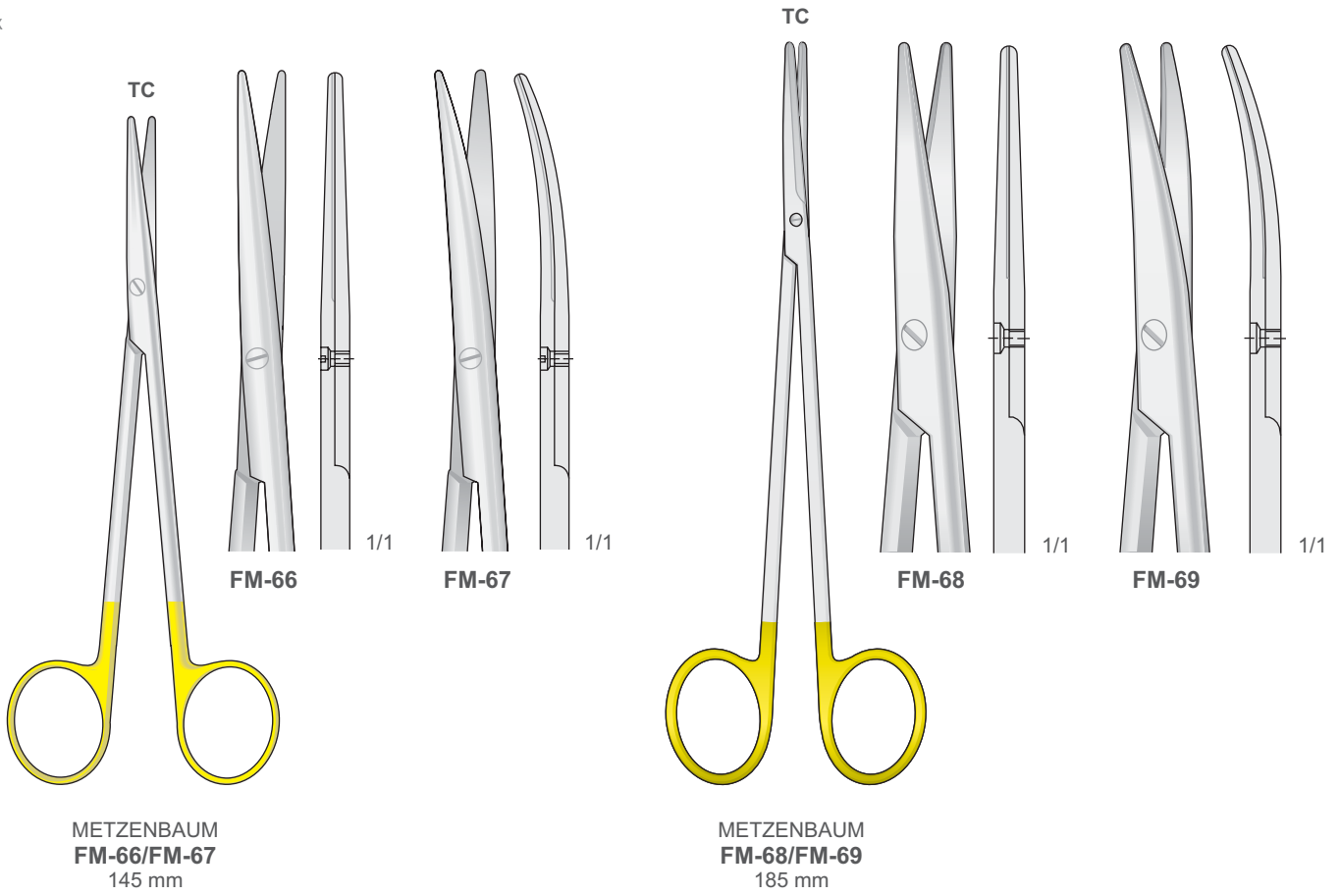



Mit Hartmetalleinsätzen - Tungsten-carbide scissors
Con punta al carburo di tungsteno - Tijeras de tungsteno - Avec plaquettes en carbure de tungstène

TC

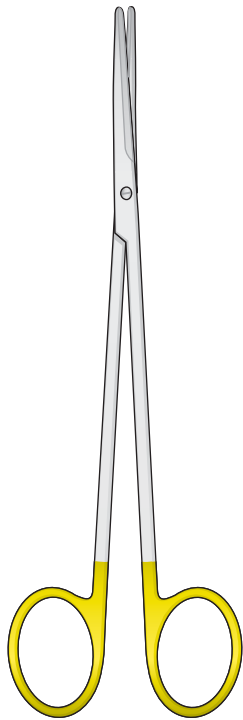

METZENBAUM-FINO
FM-201/FM-204

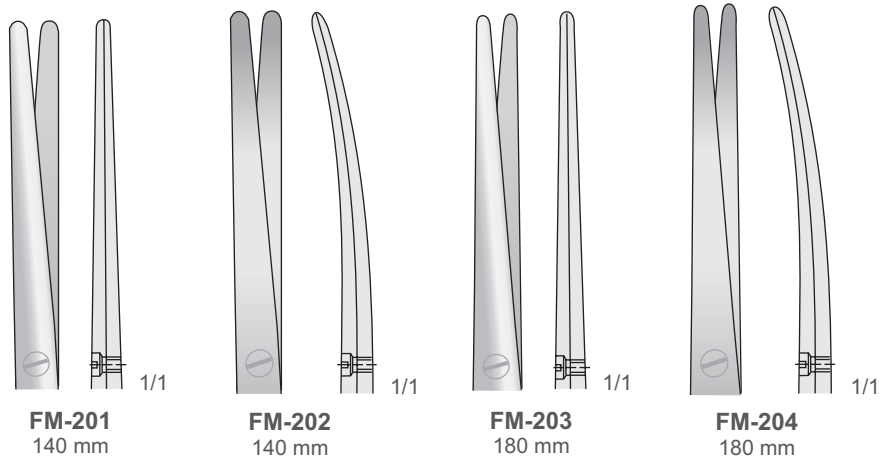

Mit Hartmetalleinsätzen - Tungsten-carbide scissors
Con punta al carburo di tungsteno - Tijeras de tungsteno - Avec plaquettes en carbure de tungstène

TC

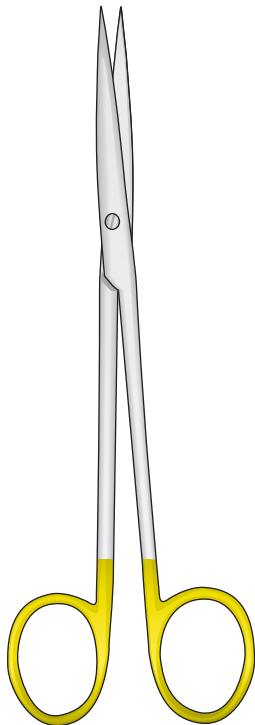

METZENBAUM-FINO
FM-96/FM-99

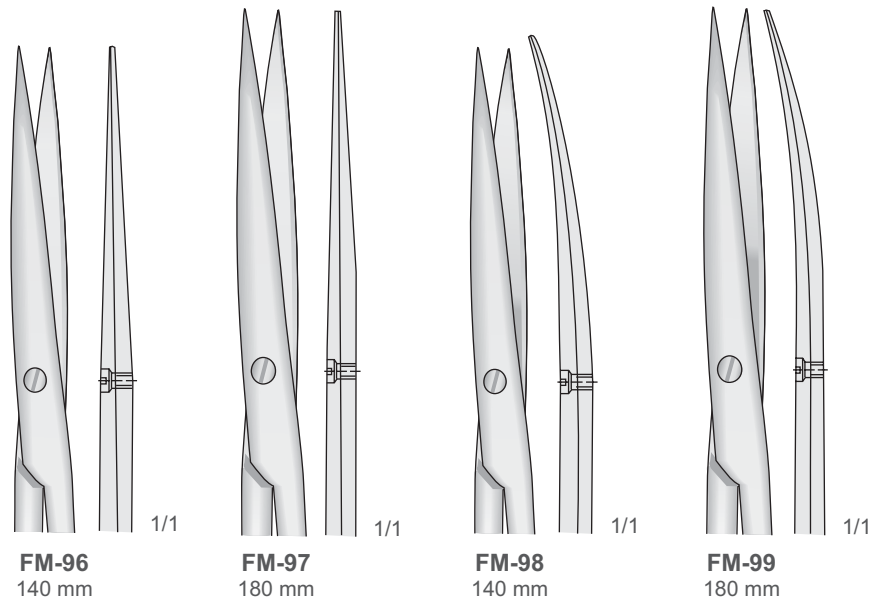



Scheren
Scissors
Forbici
Tijeras
Ciseaux

Mit Hartmetalleinsätzen - Tungsten-carbide scissors
Con punta al carburo di tungsteno - Tijeras de tungsteno - Avec plaquettes en carbure de tungstène

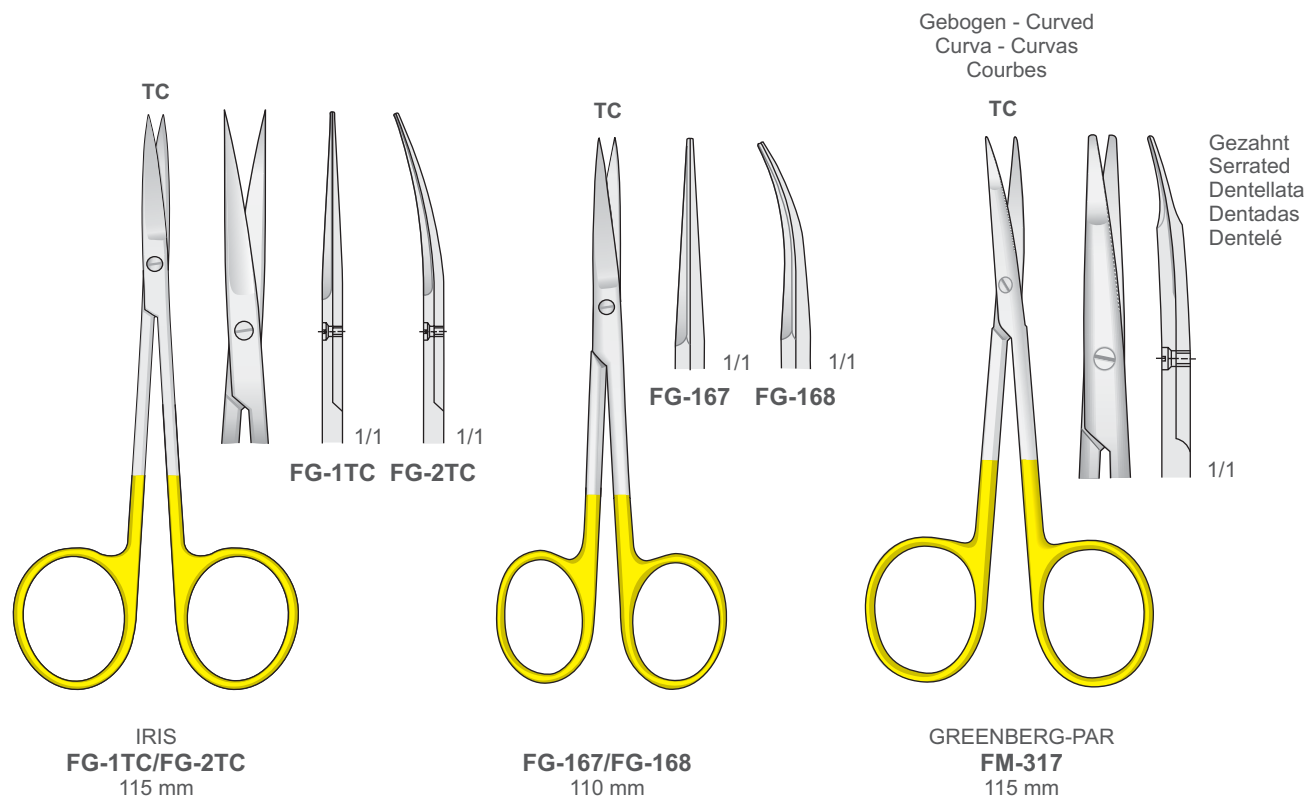
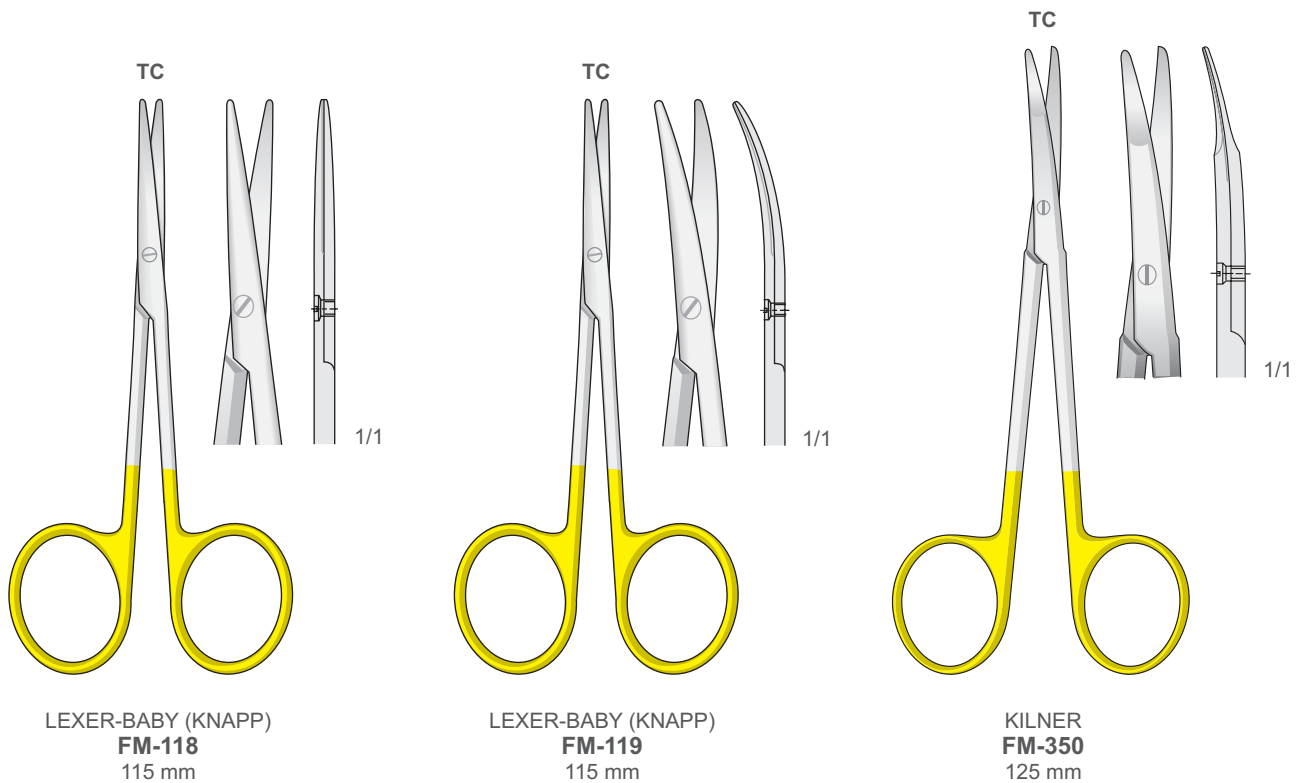



Scheren
Scissors
Forbici
Tijeras
Ciseaux

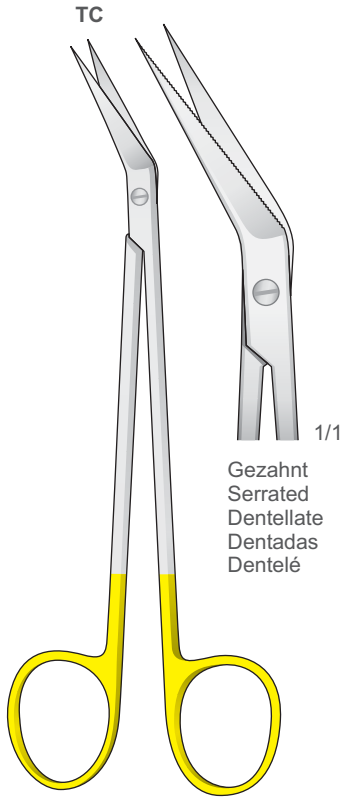

LK-10
160 mm

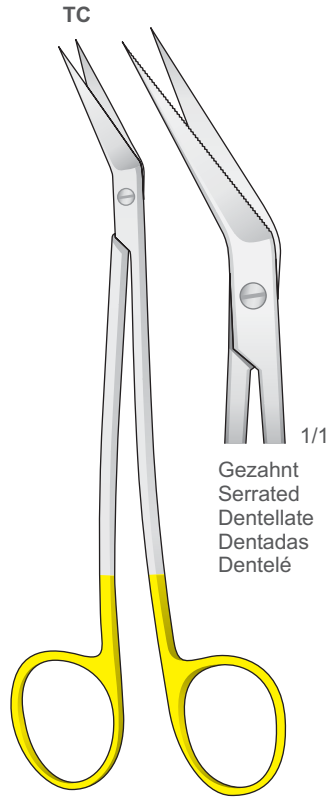

LK-12
160 mm

Mit Hartmetalleinsätzen
Tungsten-carbide scissors
Con punta al carburo di tungsteno
Tijeras de tungsteno
Avec plaquettes en carbure de tungstène

Eine Schneide gezahnt S-förmig gebogen
One toothed cutting edge S-shaped
Una lama dentata curva a forma S
Una hoja dentada forma S
Une lame dentelée courbés en S

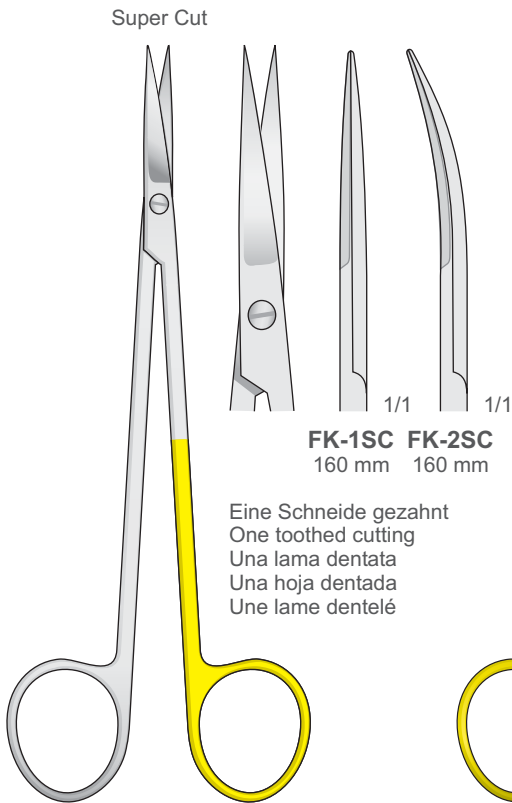

KELLY
FK-1SC/FK-2SC
160 mm

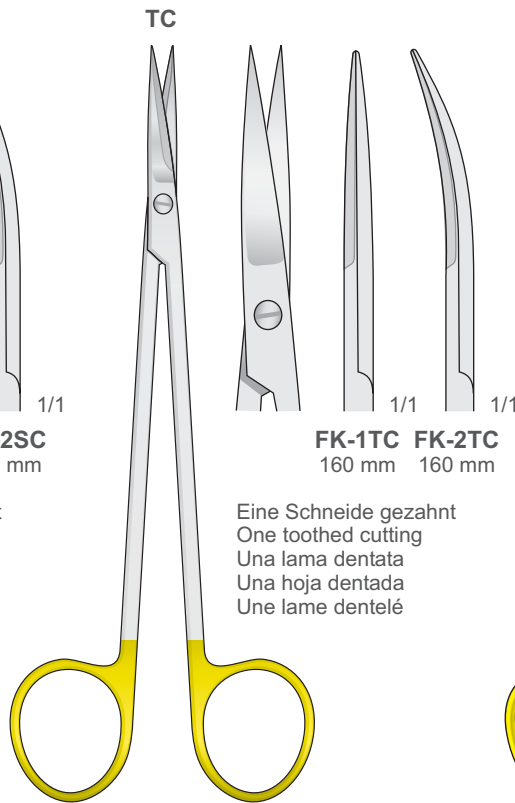

KELLY
FK-1TC/FK-2TC
160 mm

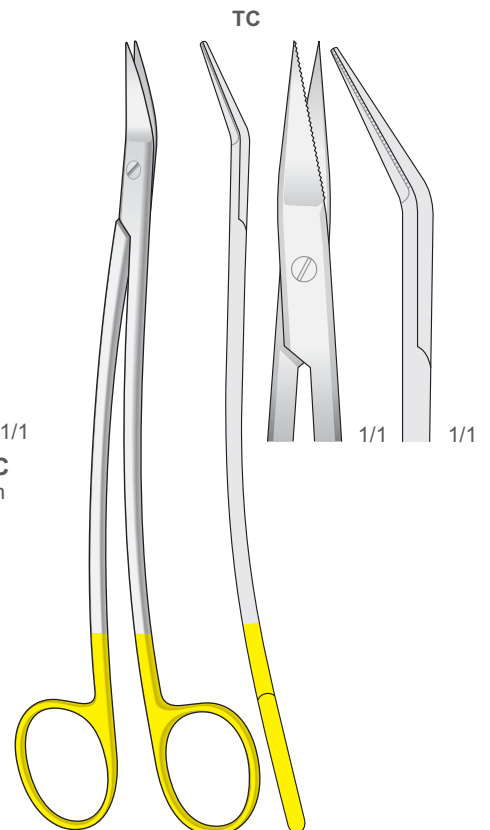

DEAN-TC
175 mm



Scheren
Scissors
Forbici
Tijeras
Ciseaux

Scheren mit wellenschliff auf einer Schnittfläche - Scissors cut one serrated cutting edge
Forbici con taglio ondulato su una lama - Tijeras con onda afilados
Ciseaux avec affutage spécial ont une lame dentée

Wellenschliff
TC

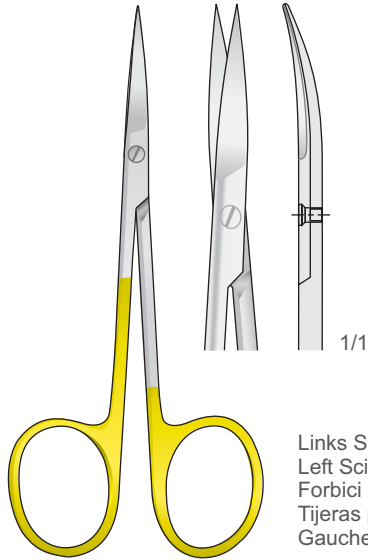

Links Scheren
Left Scissors
Forbici per mancini
Tijeras para zurdos
Gauche Ciseaux

IRIS
FM-100L
110 mm

Wellenschliff
TC

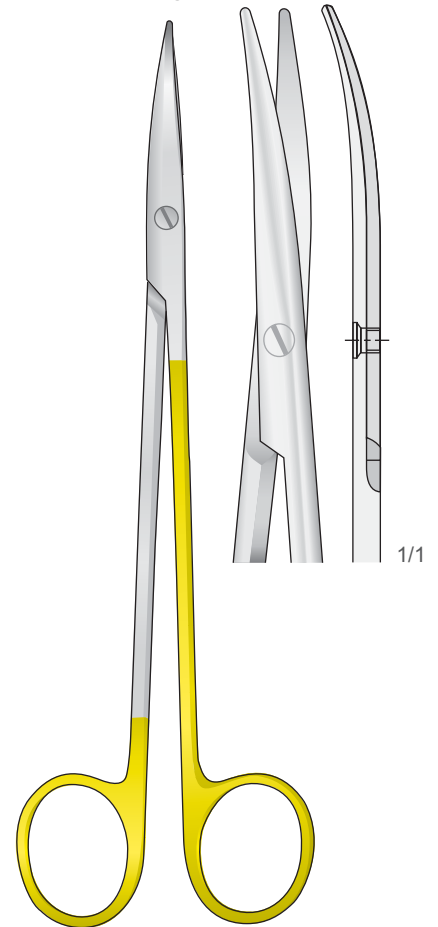

METZENBAUM
FM-104
185 mm

Wellenschliff
TC

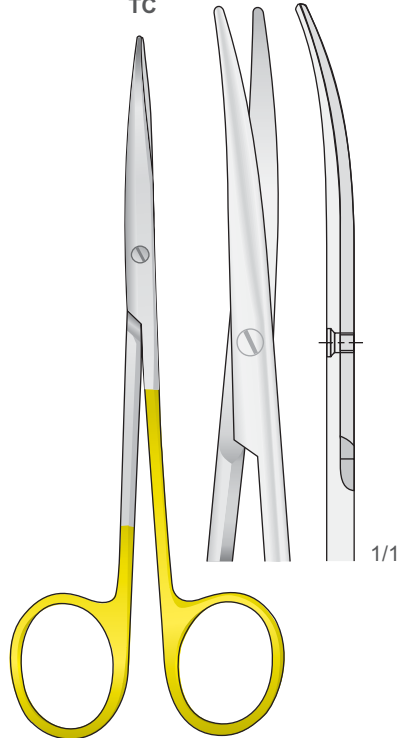

METZENBAUM
FM-102
145 mm

Wellenschliff
TC

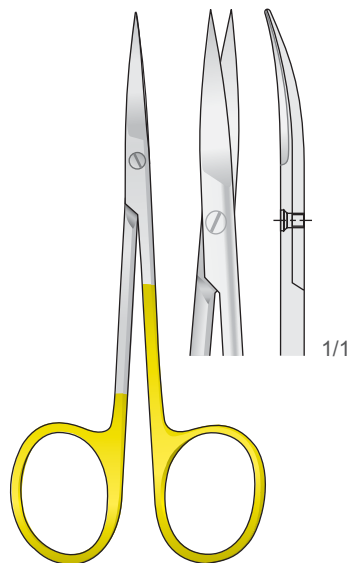

IRIS
FM-100
110 mm



Scheren
Scissors
Forbici
Tijeras
Ciseaux

“Super-cut” scheren micro-schliff für tissue atrauma
 “Super-cut” scissors for gripping tissue and cutting interproximally
 Forbici “Super-cut” estremamente taglienti per tessuti con riduzione del trauma
 Tijeras “super cortes” para cortar tissue-atrauma
 Ciseaux “super cut” coupe les tissus en reduisant les risques de traumatisme

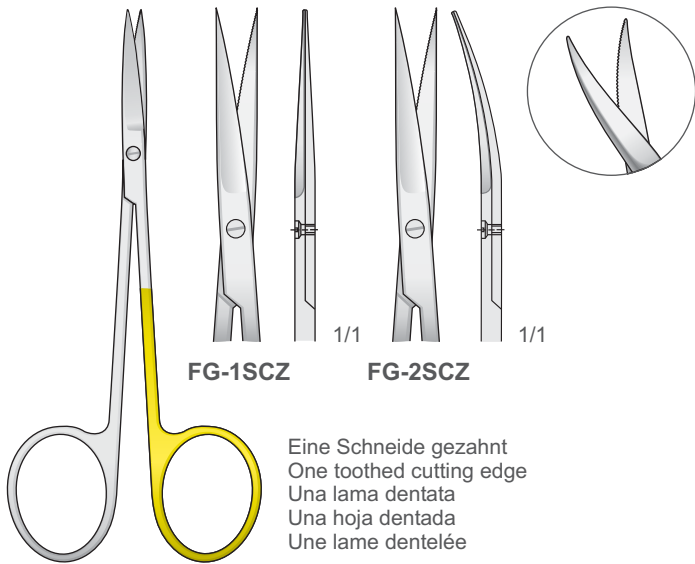

FG-1SCZ

FG-2SCZ

Eine Schneide gezahnt
 One toothed cutting edge
 Una lama dentata
 Una hoja dentada
 Une lame dentelée

FG-1SCZ/FG-2SCZ
110 mm

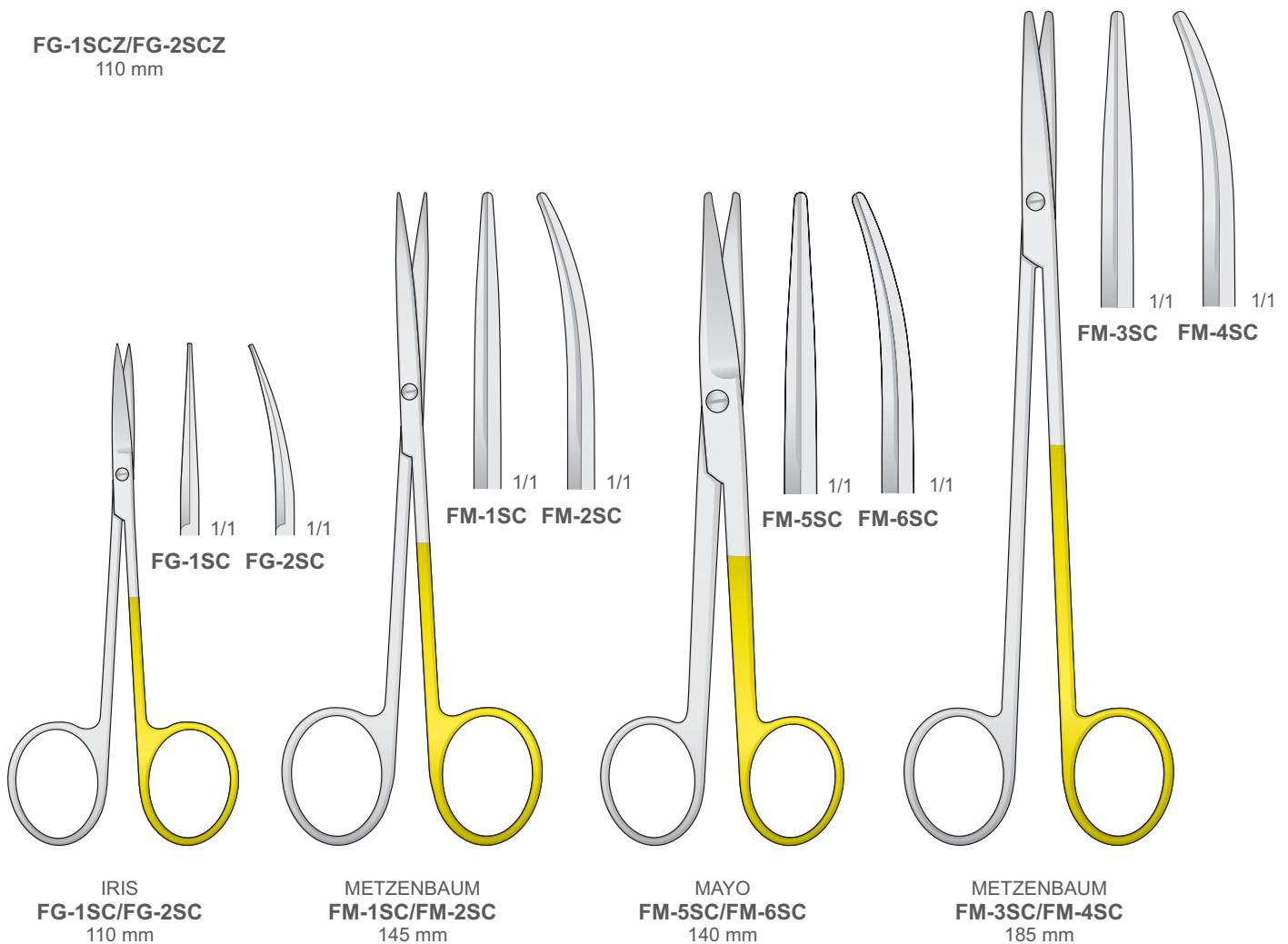

FG-1SC FG-2SC

FM-1SC FM-2SC

FM-5SC FM-6SC

FM-3SC FM-4SC

**IRIS
FG-1SC/FG-2SC**
110 mm

**METZENBAUM
FM-1SC/FM-2SC**
145 mm

**MAYO
FM-5SC/FM-6SC**
140 mm

**METZENBAUM
FM-3SC/FM-4SC**
185 mm



Scheren
Scissors
Forbici
Tijeras
Ciseaux

"Super-cut" scheren micro-schliff für tissue atrauma
 "Super-cut" scissors for gripping tissue and cutting interproximally
 Forbici "super-cut" estremamente taglienti per tessuti con riduzione del trauma
 Tijeras "super cortes" para cortar tissue-atrauma
 Ciseaux "Super Cut" avec aiguisement spécial

Gezahnt - Serrated
Dentellate - Dentada
Dentelé

Spitz
Sharp
Acute
Agudas
Pointu

Stumpf
Blunt
Smusse
Romas
Mousse

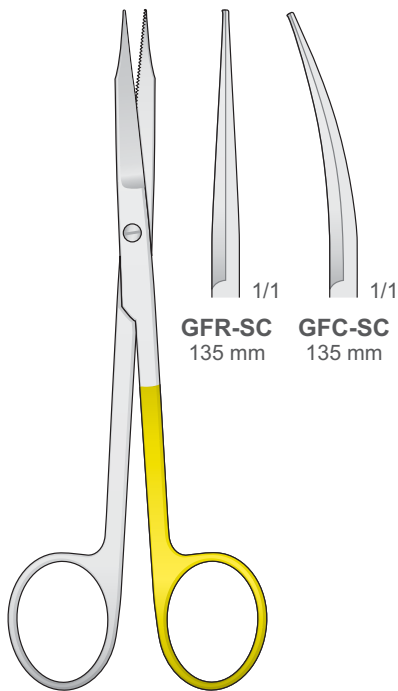

GOLDMAN-FOX
GFR-SC/GFC-SC
135 mm

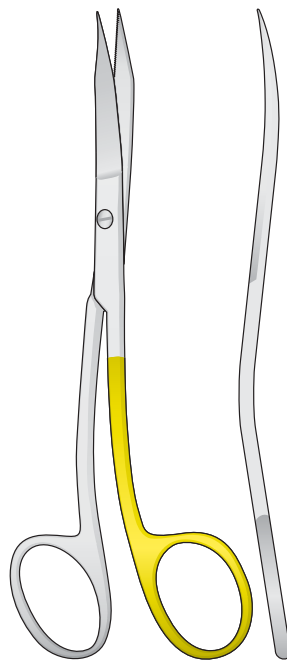

GOLDMAN-FOX S FORM
GFS-SC
130 mm

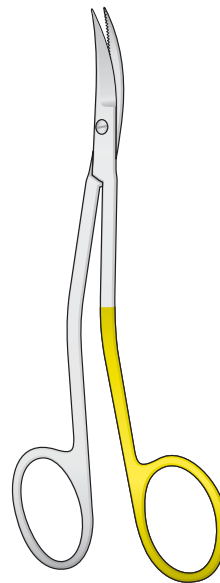

LA GRANGE
LG-1SC/LG-2SC
115 mm

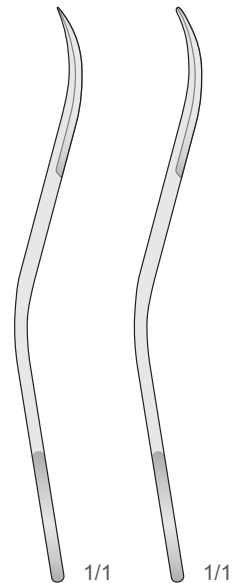

LA GRANGE LA GRANGE
LG-1C LG-2C



Scheren
Scissors
Forbici
Tijeras
Ciseaux

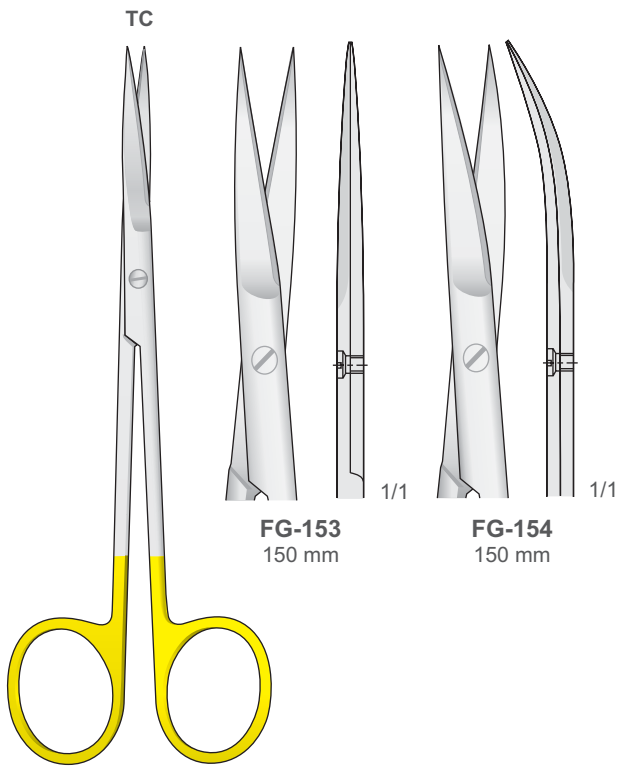

Mit Hartmetalleinsätzen
Tungsten-carbide scissors
Con punta al carburo di tungsteno
Tijeras de tungsteno
Avec plaquettes en carbure de tungstène

JOSEPH
FG-153/FG-154
150 mm

Gezahnt - Serrated
Dentellate - Dentadas
Dentelé

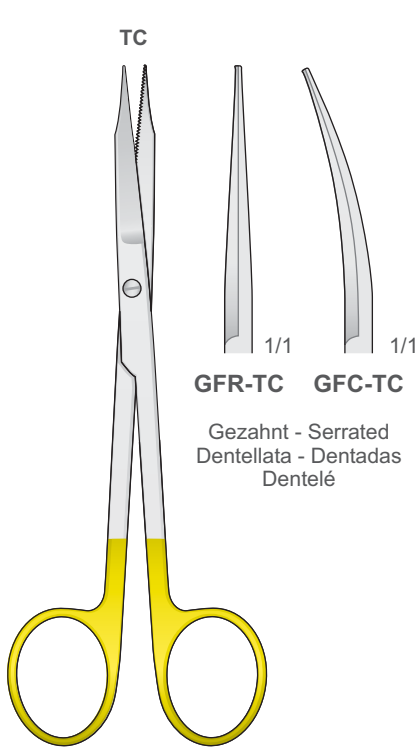

GOLDMAN-FOX
GFC-TC/GFR-TC
135 mm

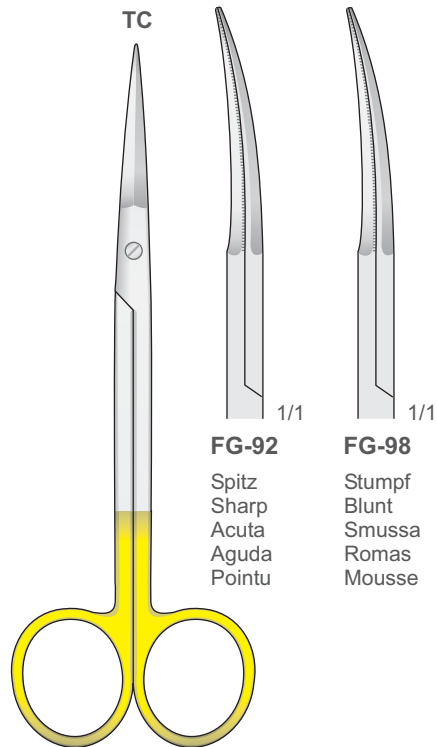

PECK-JOSEPH
FG-92/FG-98
140 mm

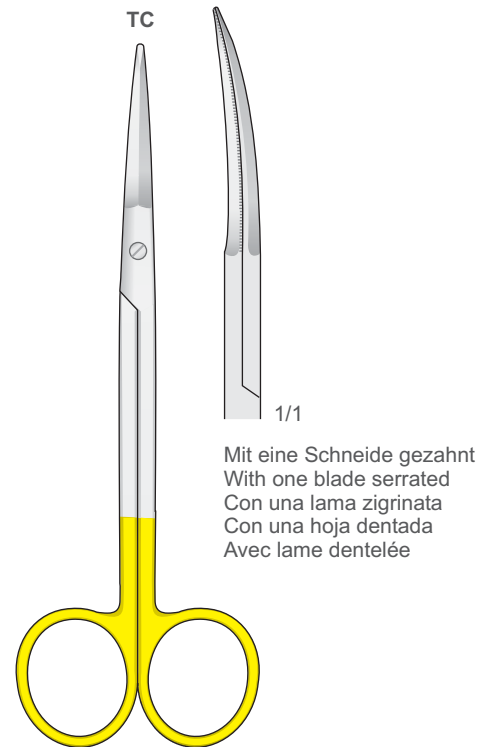

GREGORY
FM-339
140 mm

Mit eine Schneide gezahnt
With one blade serrated
Con una lama zigrinata
Con una hoja dentada
Avec lame dentelée



Scheren
Scissors
Forbici
Tijeras
Ciseaux

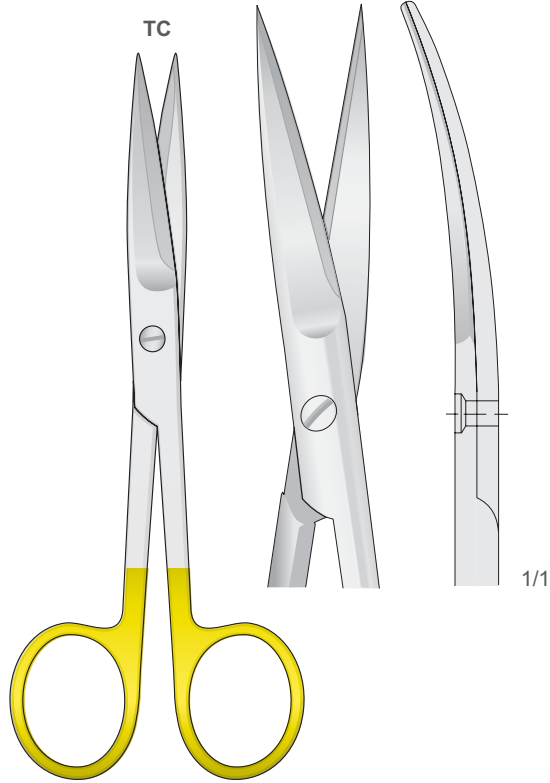

Mit Hartmetalleinsätzen
Tungsten-carbide scissors
Con punta al carburo di tungsteno
Tijeras de tungsteno
Avec plaquettes en carbure de tungstène

FM-146
145 mm

Draht- und Blehschere gezahnt
Wire cutting scissor serrated
Forbice universale dentellata
Tijeras para cortar hilo de acero dentadas
Coupe-fils dentelés

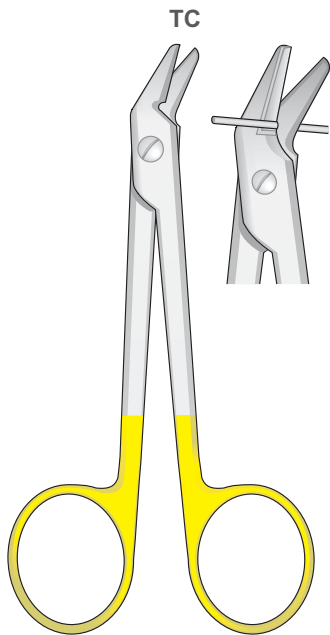

DP-120
120 mm

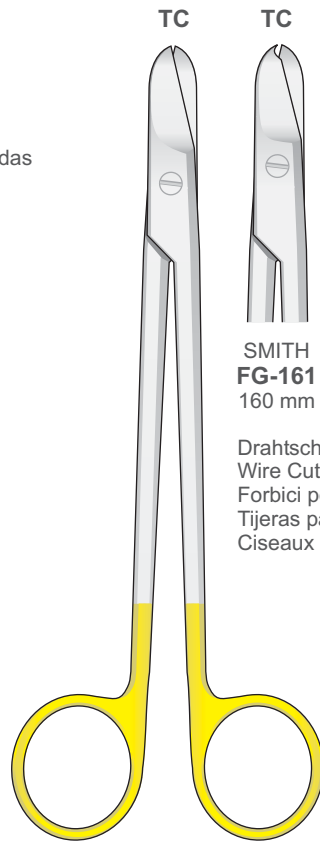

**SMITH
FG-160**
160 mm

Drahtschere
Wire Cutting Scissors
Forbici per fili
Tijeras para Alambre
Ciseaux à fils

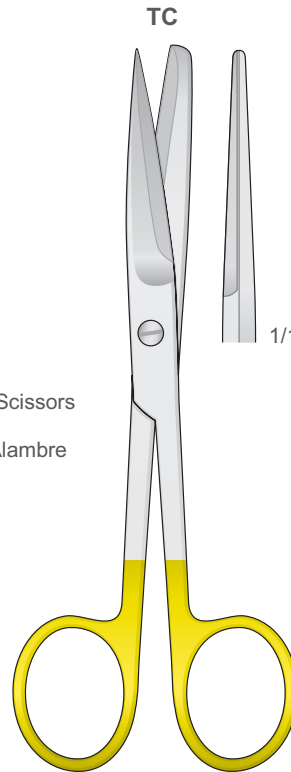

FM-51
145 mm

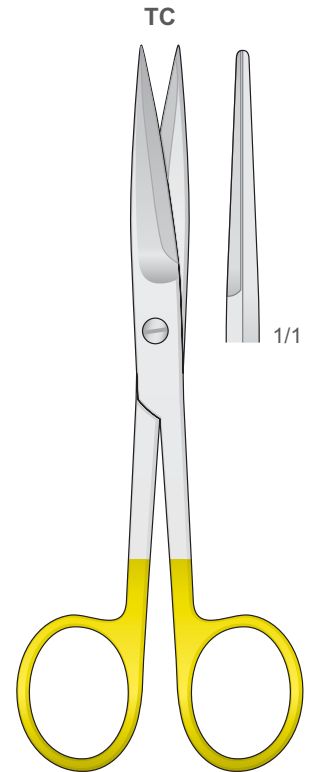

FM-59
145 mm



Ligatur Scheren
Ligature Scissors
Forbici per legature
Tijeras para ligaduras
Ciseaux à ligatures

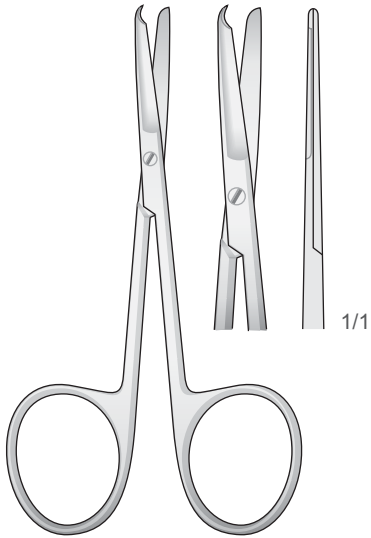

SPENCER
SC-9
90 mm

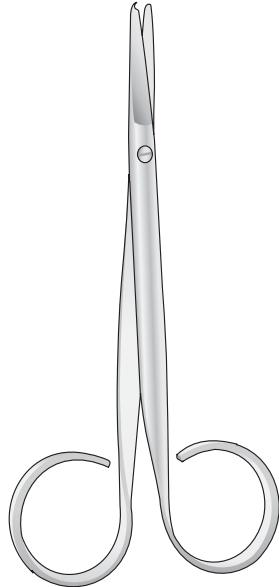

SPENCER
SC-1
110 mm

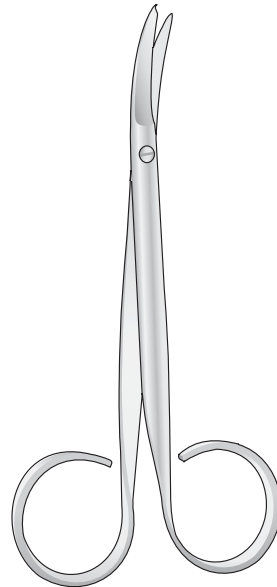

SPENCER
SC-5
110 mm

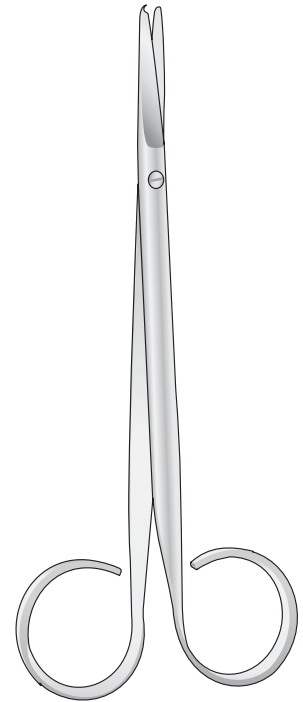

SPENCER
SC-2
145 mm

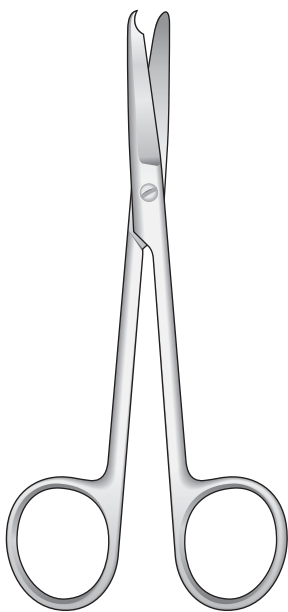

SPENCER
SC-14
120 mm

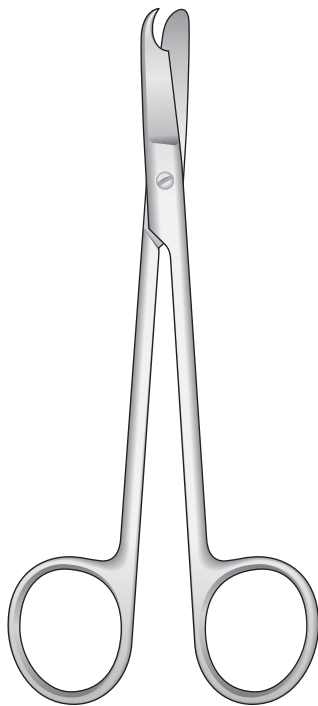

LITTAUER
SC-15
140 mm

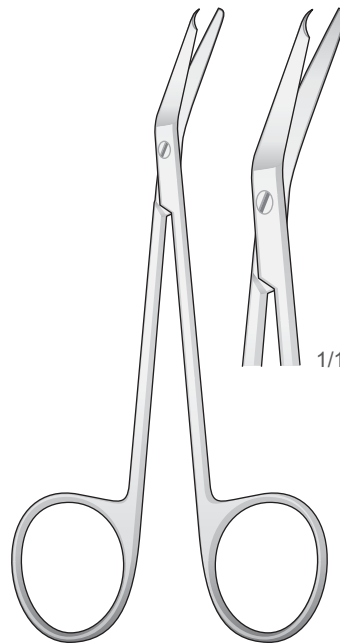

SPENCER
SC-13
130 mm

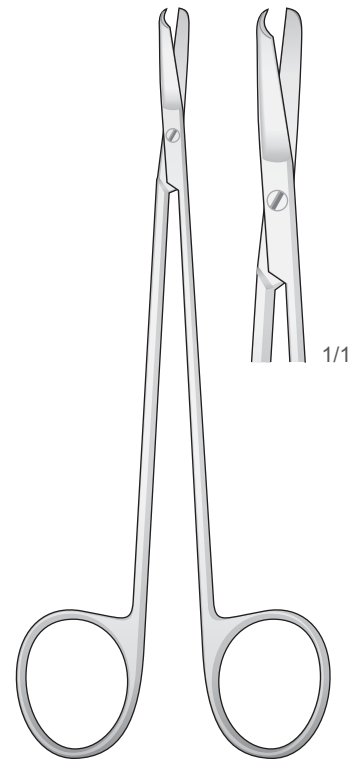

KELLY
SC-16
150 mm



Draht und blechscheren
Wire and plate cutting scissors
Forbici per fili metallici
Tijeras para cortar alambre
Ciseaux coupe-fils métalliques

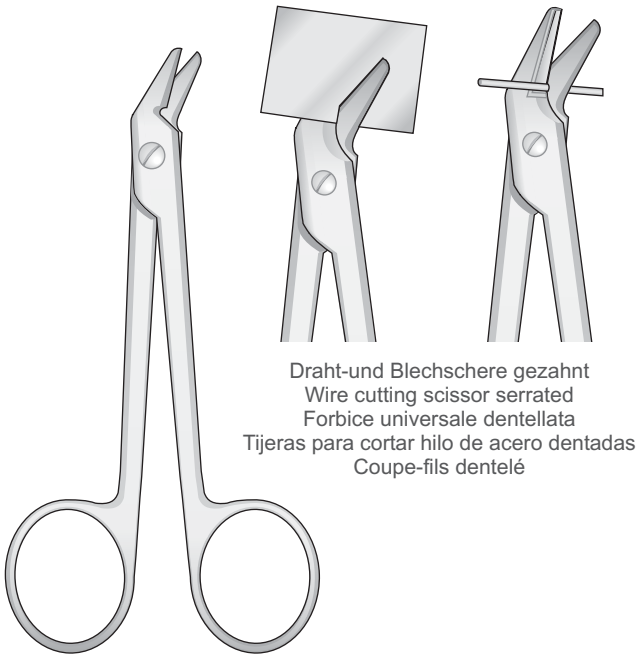

Draht-und Blechscherre gezahnt
Wire cutting scissor serrated
Forbice universale dentellata
Tijeras para cortar hilo de acero dentadas
Coupe-fils dentelé

DP-90
120 mm

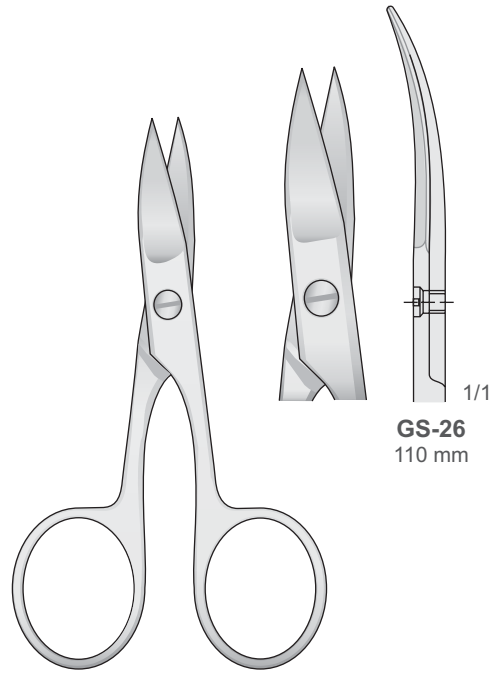

GS-26
110 mm

GS-26
110 mm

Spitz
Sharp
Acute
Agudas
Pointu



BEEBE
DP-91/DP-101
110 mm

Stumpf
Blunt
Smusse
Romas
Mousse

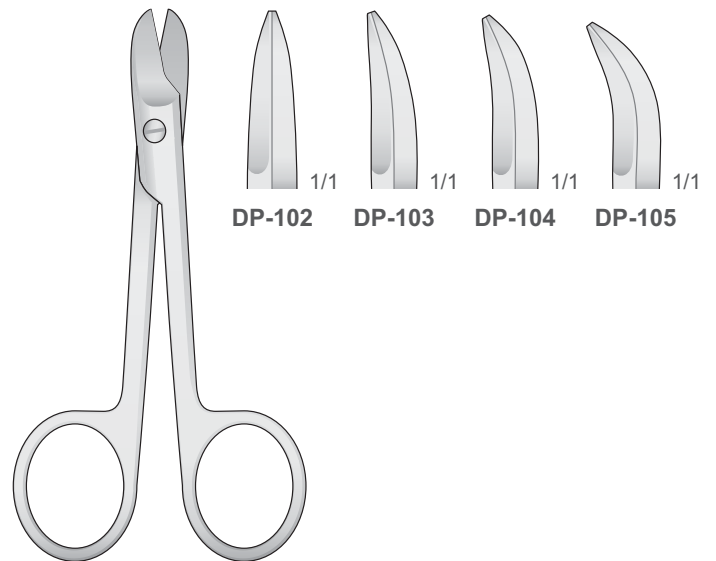

BEEBE
DP-102/DP-105
110 mm

.5

Pinzetten
Tissue Pliers
Pinzette
Pinzas
Pinces

Zahnärztliche Chirurgie
Dental surgery
Chirurgia dentale
Cirugia dental
Chirurgie dentaire





Mikro Pinzetten
Delicate Forceps
Micro Pinzette
Pinzas finas
Micro Pinces

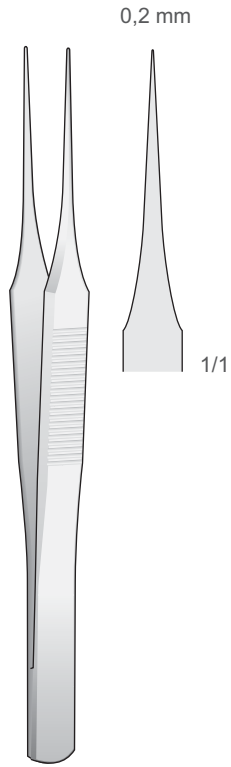

BD-360
110 mm

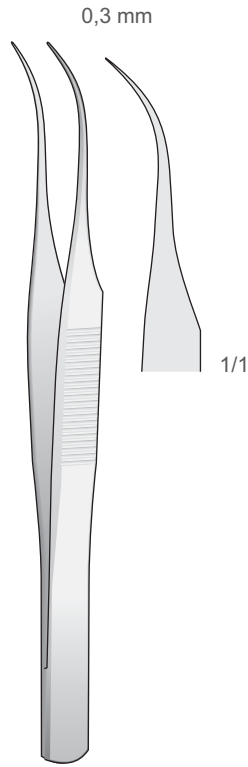

BD-361
110 mm

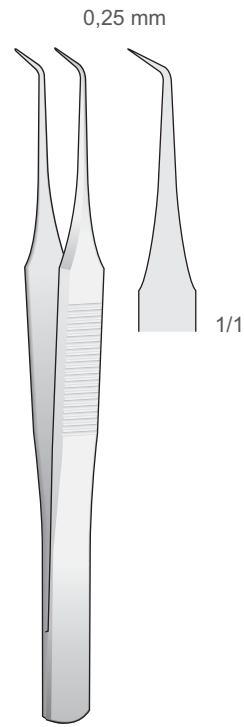

BD-362
100 mm

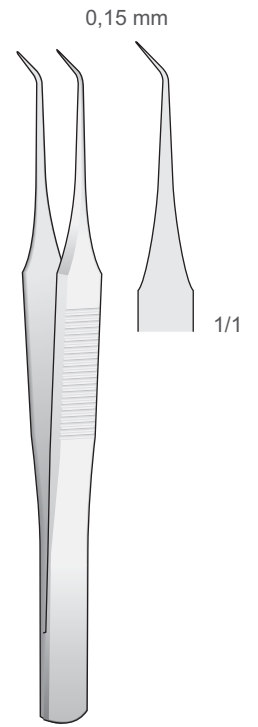

BD-363
100 mm

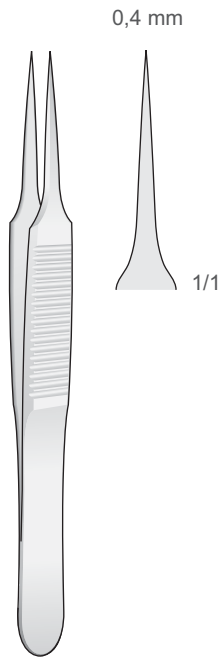

BD-364
110 mm

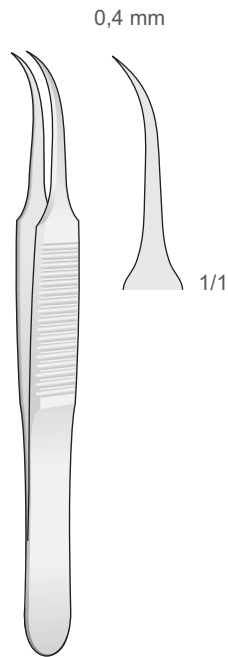

BD-365
110 mm

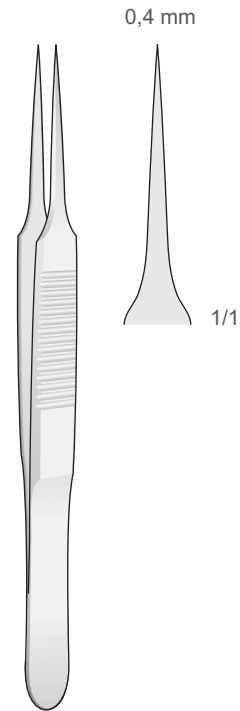

BD-366
130 mm

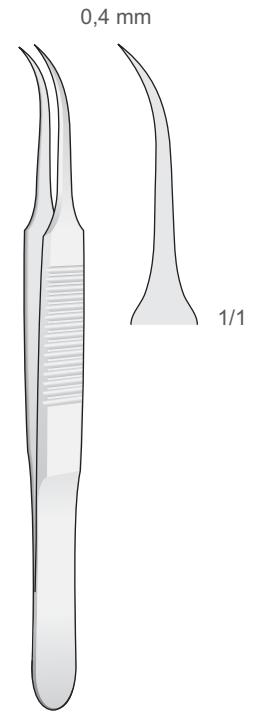

BD-367
130 mm



Mikro Pinzetten
Delicate Forceps
Micro Pinzette
Pinzas finas
Micro Pincas

Mikro diamantiertes Maul
Micro Diamond Jaw
Micro punta diamantata
Micro boca diamantada
Micro mors diamanté

Tissue Forceps
1x2 Teeth

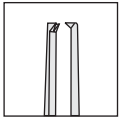

BISHOP-HARMON
MF-177 0,6 mm
85 mm

Dressing Forceps
criss-cross serrated tips

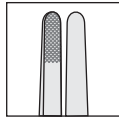

BISHOP-HARMON
MF-249 0,6 mm
85 mm

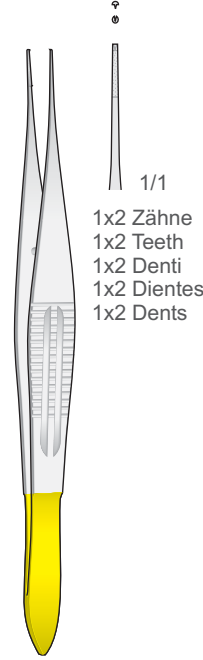

CASTROVIEJO
BD-348 0.9 mm
120 mm

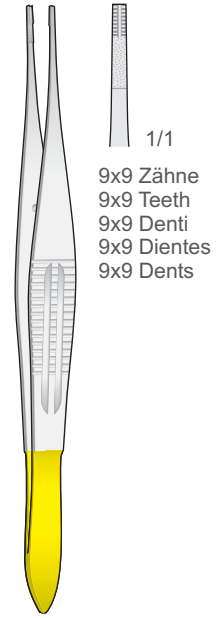

BROWN
BD-349
120 mm

1,2 mm

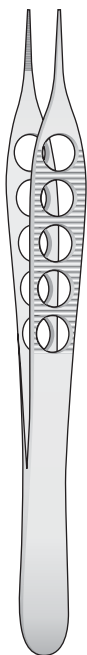

ADSON
BD-207
120 mm

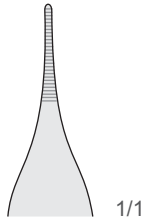

1,2 mm

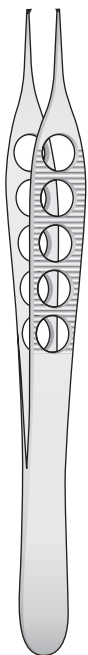

ADSON
BD-208
120 mm

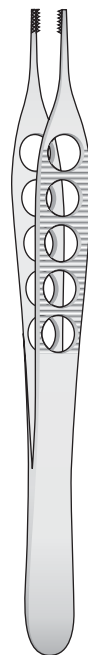
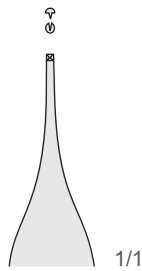

ADSON-BROWN
BD-209
120 mm

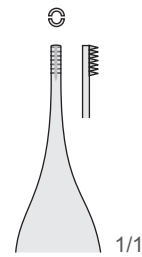

7x7 Zähne
7x7 Teeth
7x7 Denti
7x7 Dientes
7x7 Dents



ADSON-BROWN
BD-253
120 mm

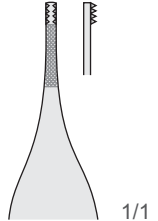



Mikro Pinzetten
Delicate Forceps
Micro Pinzette
Pinzas finas
Micro Pincers

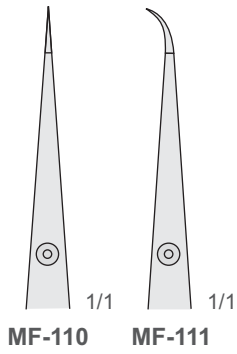
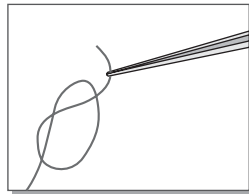

MF-110/MF-111
120 mm

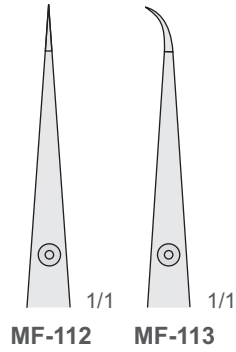
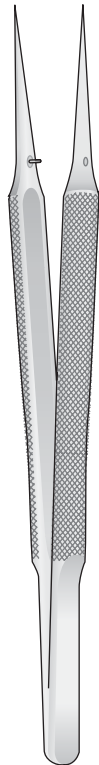

MF-112/MF-113
150 mm

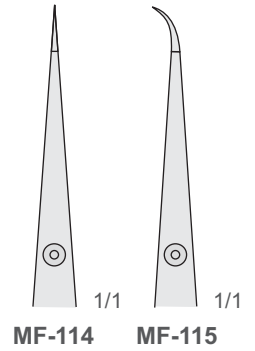
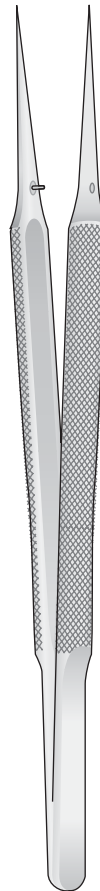

MF-114/MF-115
180 mm



Mikro Pinzette - Rundgriff Ø 8 mm
Mit Führungsstift diamantiert
Fadenplatte 6x0,7 mm

Mikro Pinzetten
Micro Forceps
Micro Pinzette
Micro Pinzas
Micro Pincés

Diamantiert
Diamond Coated
Diamantate
Diamantadas
Diamanté

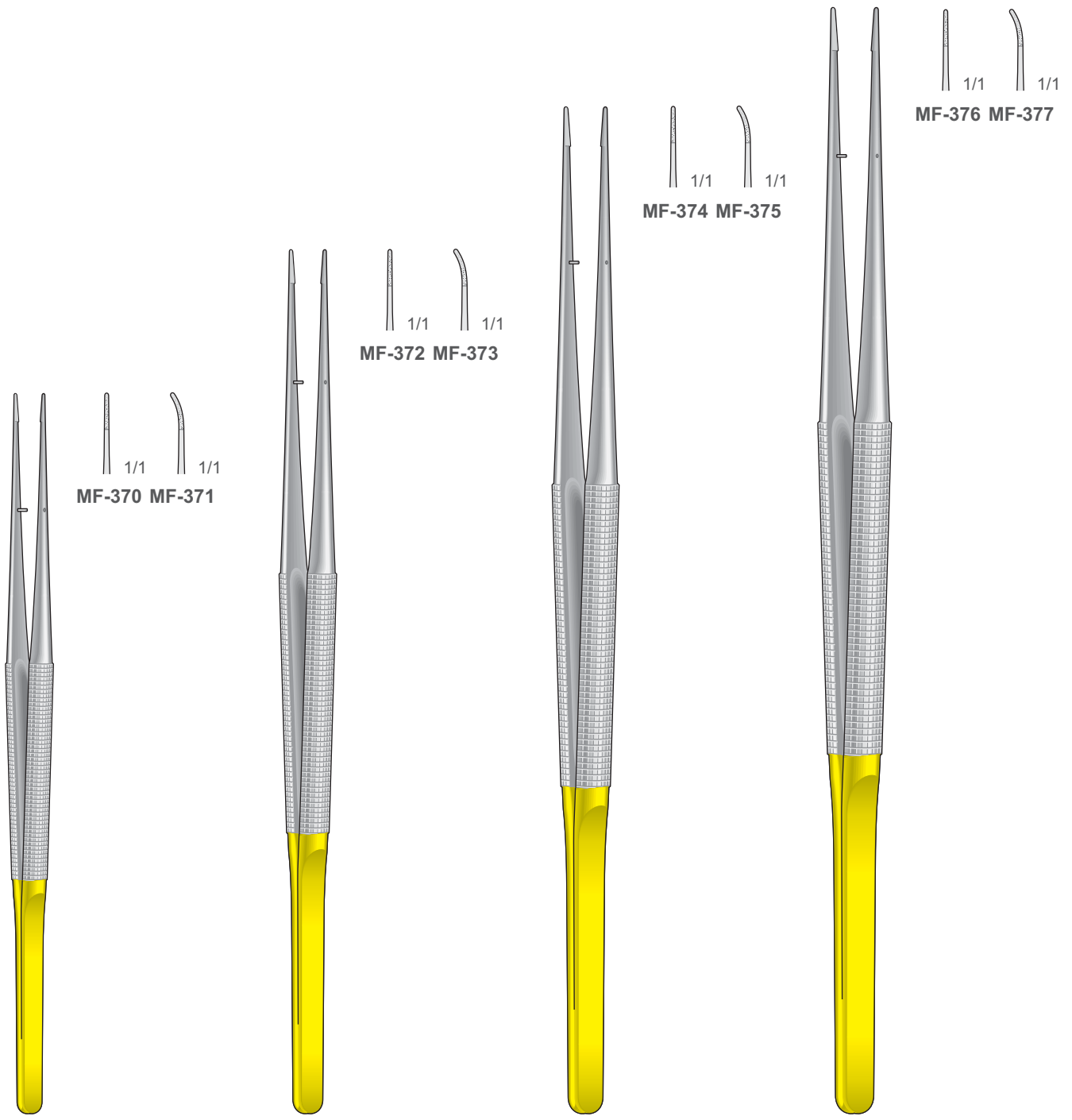

MF-370/MF-371
150 mm

MF-372/MF-373
180 mm

MF-374/MF-375
210 mm

MF-376/MF-377
230 mm



Mikro Pinzetten
Micro Forceps
Micro Pinzette
Micro Pinzas
Micro Pincés

Mikro Pinzette - Rundgriff Ø 8 mm
Mit Führungsstift diamantiert
Fadenplatte 6x0,7 mm

Diamantiert
Diamond Coated
Diamantate
Diamantadas
Diamanté

1x2 Zähne
1x2 Teeths
1x2 Denti
1x2 Dientes
1x2 Dents

1x2 Zähne
1x2 Teeths
1x2 Denti
1x2 Dientes
1x2 Dents

1x2 Zähne
1x2 Teeths
1x2 Denti
1x2 Dientes
1x2 Dents

1x2 Zähne
1x2 Teeths
1x2 Denti
1x2 Dientes
1x2 Dents

1/1 1/1
MF-384 MF-385

1/1 1/1
MF-382 MF-383

1/1 1/1
MF-380 MF-381

1/1 1/1
MF-378 MF-379

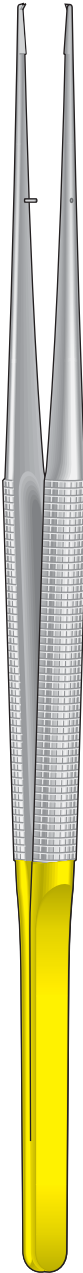

MF-378/MF-379
150 mm

MF-380/MF-381
180 mm

MF-382/MF-383
210 mm

MF-384/MF-385
230 mm



Titan-Pinzetten
Titanium Tissue Forceps
Pinzette in titanio
Pinzas de titanio
Pincas en titane

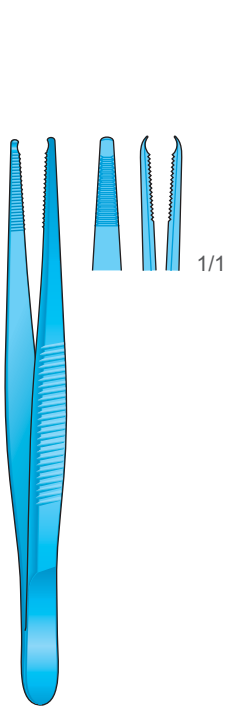

BD-285T
90 mm

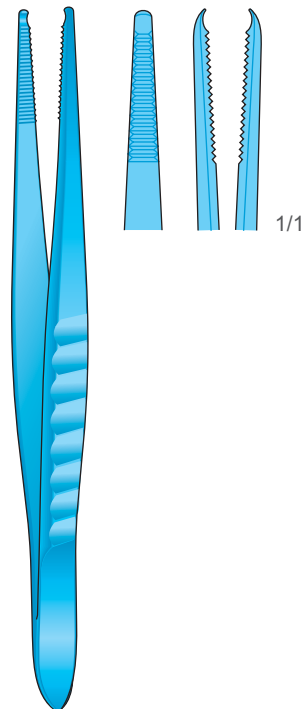

BD-270T
130 mm

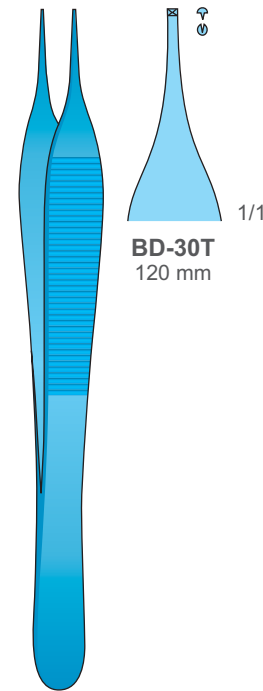

ADSON
BD-30T
120 mm

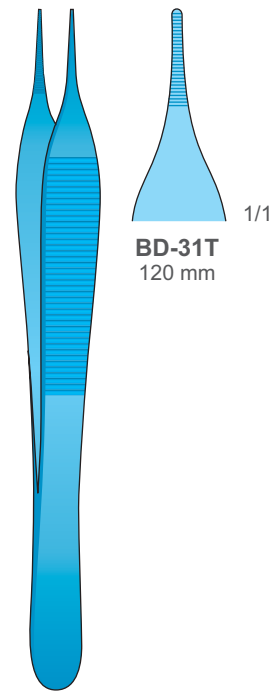

ADSON
BD-31T
120 mm

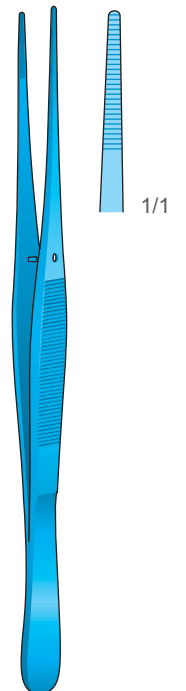

BD-09T
130 mm

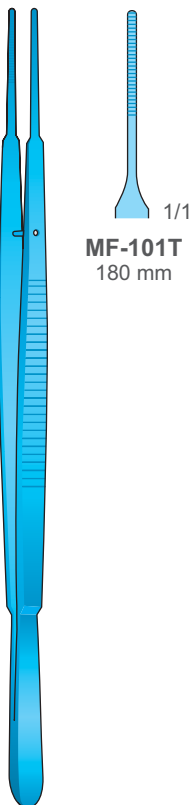

GERALD
MF-101T/MF-102T
180 mm

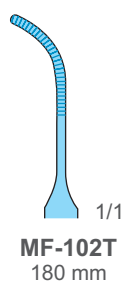

MF-101T
180 mm

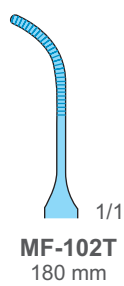

MF-102T
180 mm

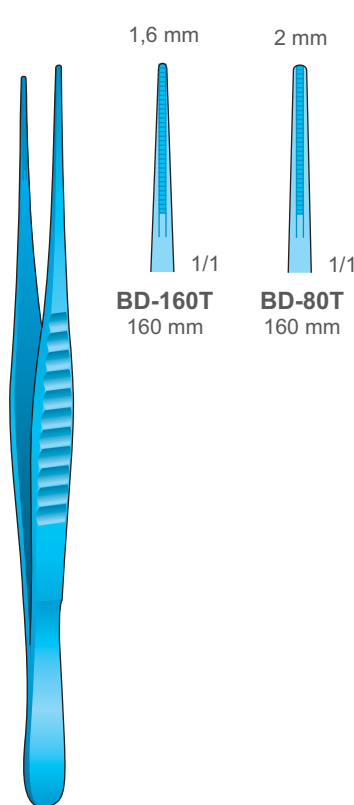

DE BAKEY
BD-80T/BD-160T

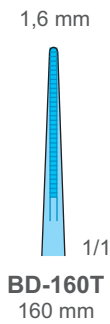

BD-160T
160 mm

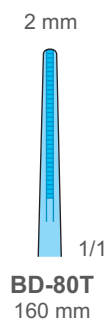

BD-80T
160 mm

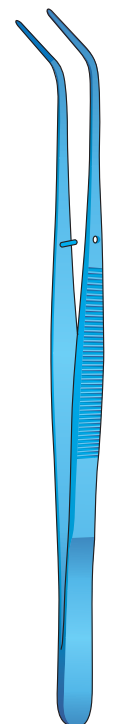

COLLEGE
TT-01
150 mm

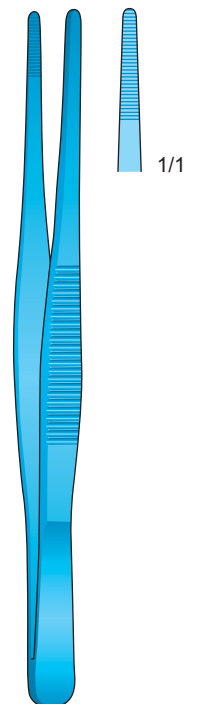

BD-75T
145 mm



Mikro Pinzetten
Delicate Forceps
Micro Pinzette
Pinzas finas
Micro Pincers

Rund-Griffe Ø 8 mm
Round handle Ø 8 mm
Manico rotondo Ø 8 mm
Mango redondo Ø 8 mm
Manche rond Ø 8 mm

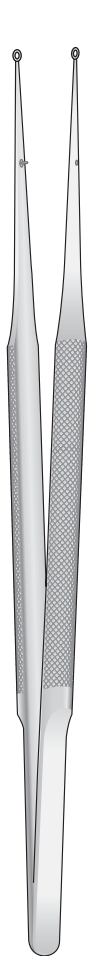

Ø 1 mm



MF-124 - 150 mm
MF-125 - 180 mm
MF-126 - 210 mm

Ø 2 mm



MF-127 - 150 mm
MF-128 - 180 mm
MF-129 - 210 mm

Titan
Titanium
Titanio
Titano
Titane

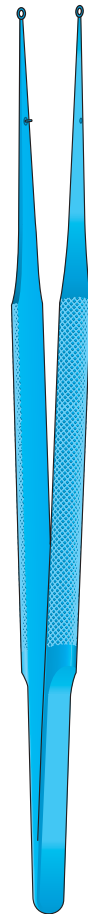

Ø 1 mm



MF-142T - 150 mm
MF-143T - 180 mm
MF-144T - 210 mm

Ø 2 mm



MF-145T - 150 mm
MF-146T - 180 mm
MF-147T - 210 mm

MF-124/MF-129

MF-142T/MF-147T



Zahnpinzetten
Cotton and Dressing Pliers
Pinzette per medicazione
Pinzas para vendajes
Précettes pour cotton

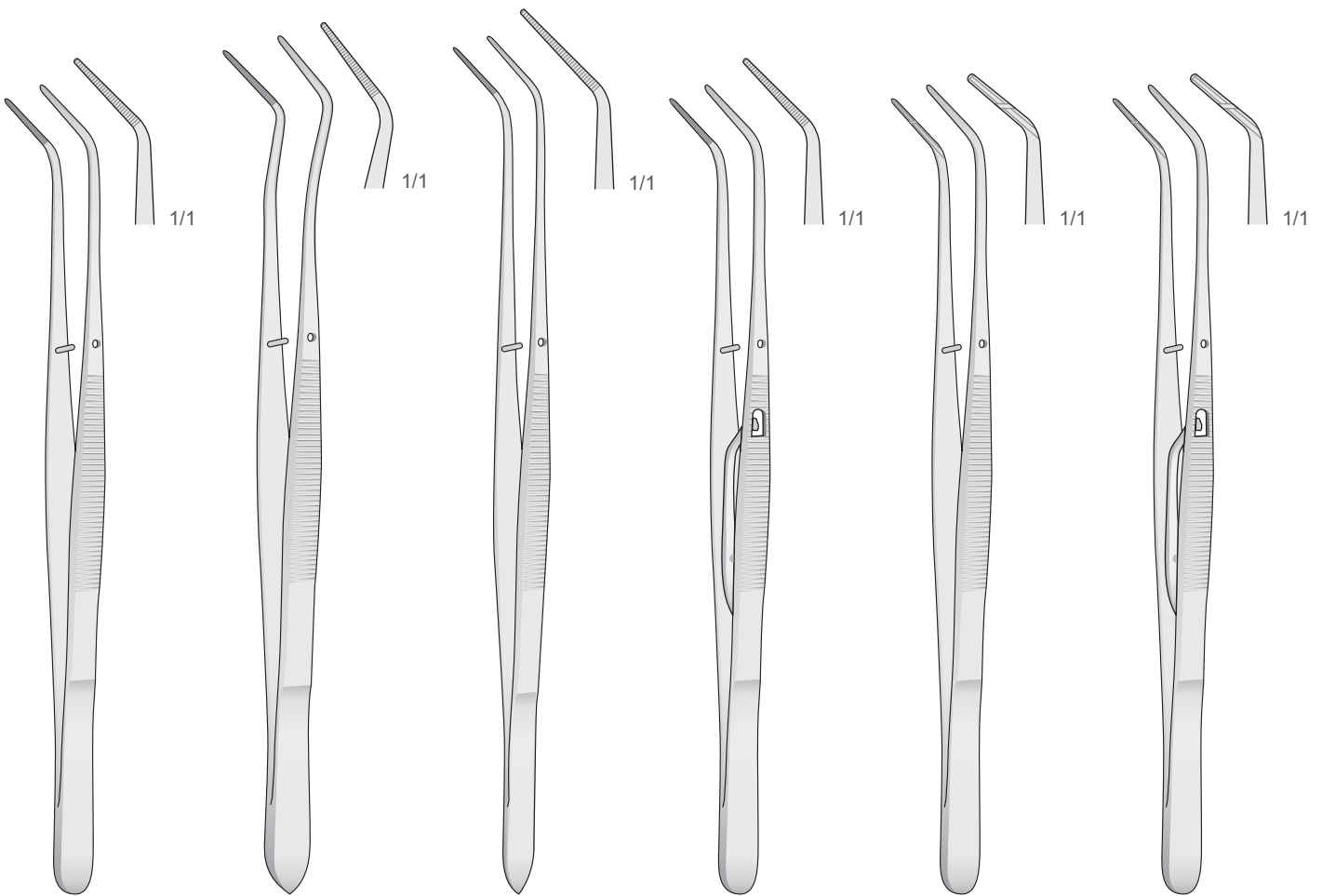

COLLEGE
150 mm

MERIAM
160 mm

FLAGG
160 mm

COLLEGE-S
150 mm

DA-04
150 mm

DA-05
150 mm



Zahnpinzetten
Cotton and Dressing Pliers
Pinzette per medicazione
Pinzas para vendajes
Précelles pour cotton

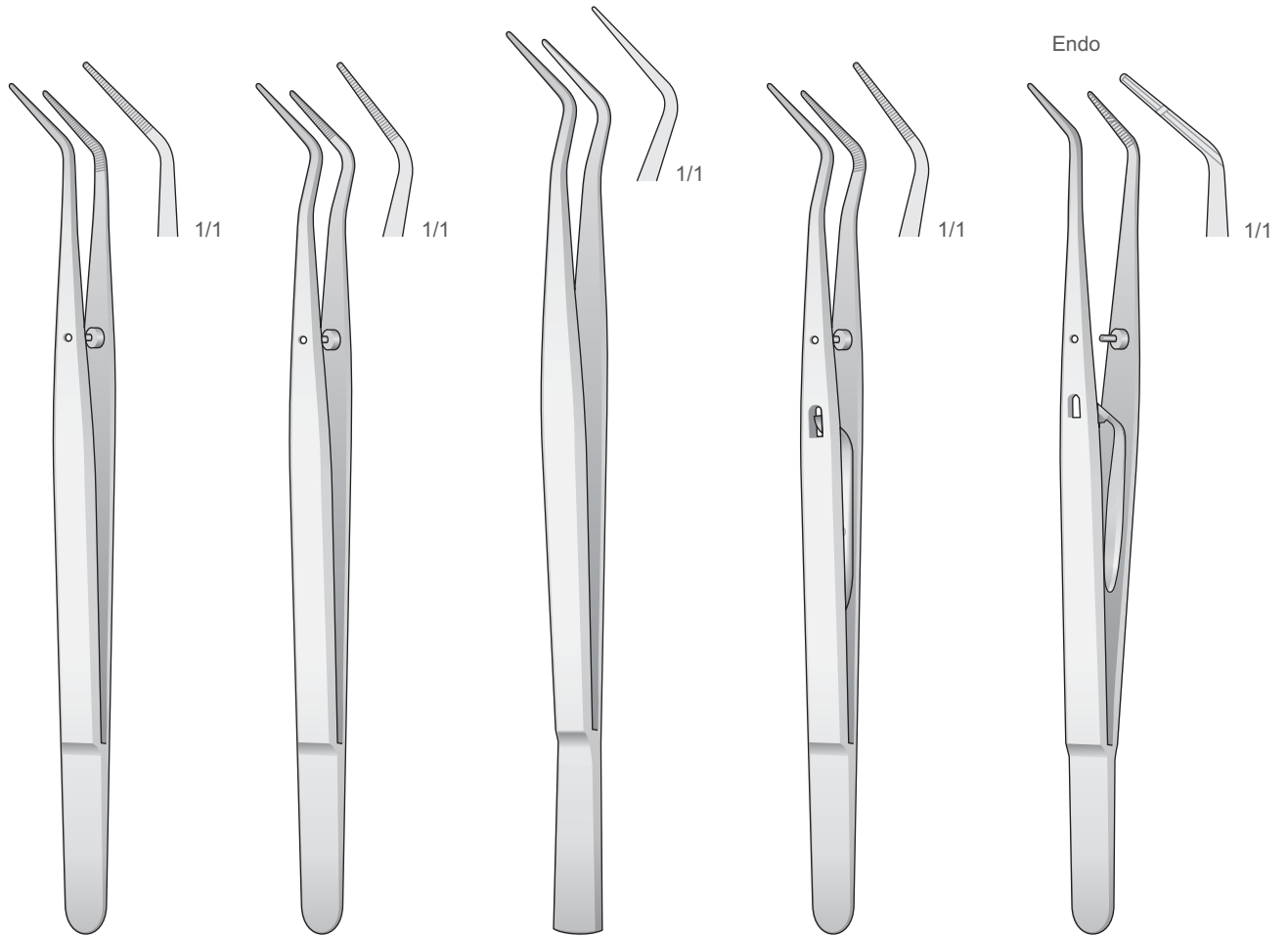

COLLEGE
BD-01 Fig.17
150 mm

MERIAM
BD-02 Fig.18
150 mm

CAULK
BD-11
160 mm

LOCKING
BD-03 Fig.18L
150 mm

Endo
DA-09
150 mm



Chirurgische und Anatomische Pinzetten
 Tissue and Dressing Forceps
 Pinzette anatomiche e chirurgiche
 Pinzas de diseccion y chirurgicalas
 Pincas anatomiques chirurgicales

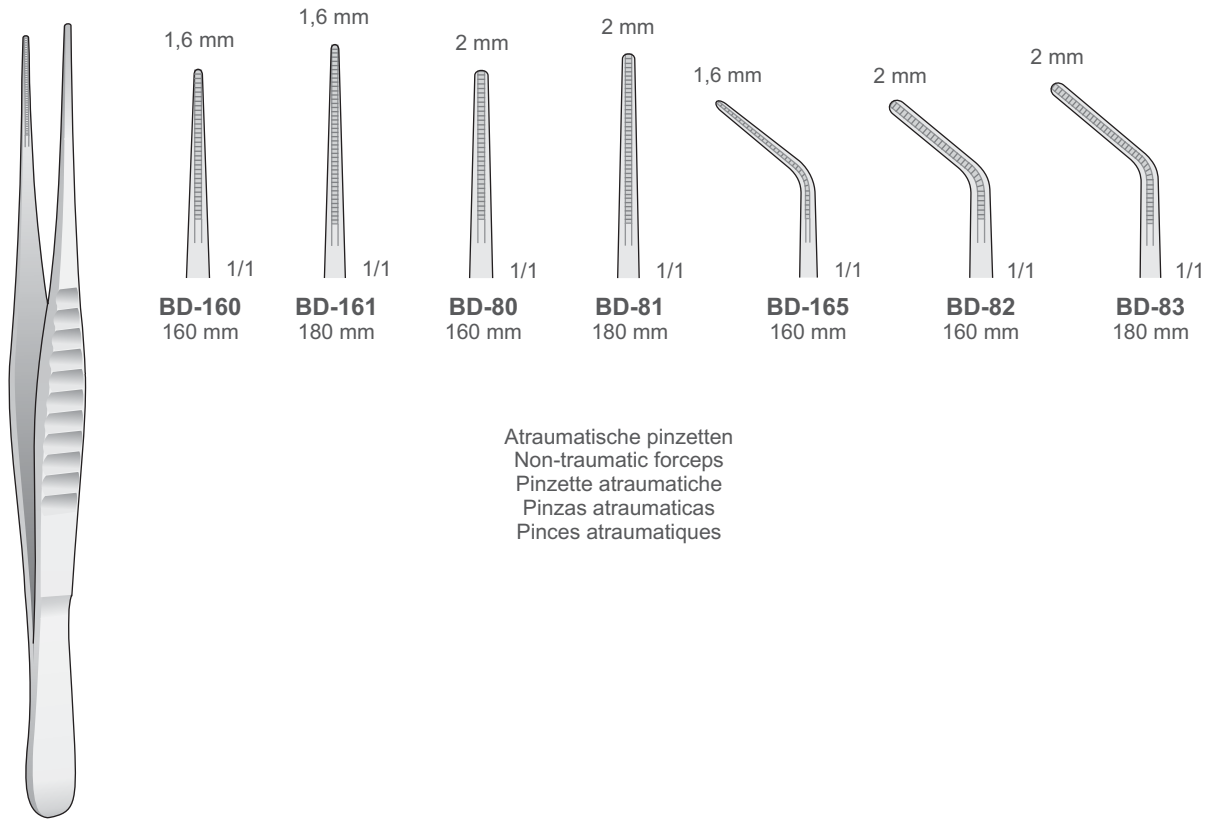

BD-160 160 mm **BD-161** 180 mm **BD-80** 160 mm **BD-81** 180 mm **BD-165** 160 mm **BD-82** 160 mm **BD-83** 180 mm

Atraumatische pinzetten
 Non-traumatic forceps
 Pinzette atraumatiche
 Pinzas atraumaticas
 Pincas atraumatiques

DE BAKEY
BD-80/BD-165

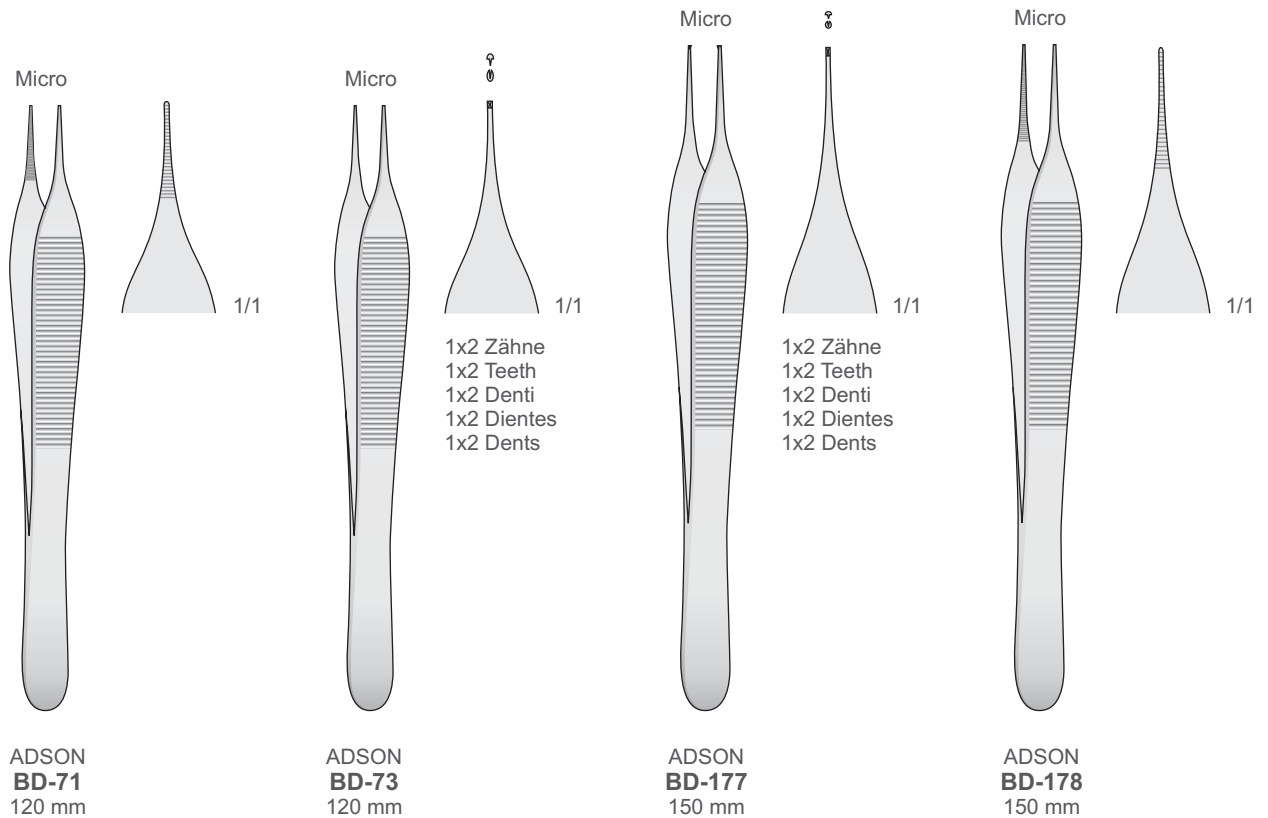

ADSON BD-71 120 mm **ADSON BD-73** 120 mm **ADSON BD-177** 150 mm **ADSON BD-178** 150 mm



Chirurgische Pinzetten
Tissue Forceps
Pinzette chirurgiche
Pinzas quirúrgicas
Pincas quirúrgicas

Taschenmarkierungspinzetten
Pocket markers
Pinzette segnatasche
Pinzas para marcar el sulco periodontal
Pincas à marquer la poche

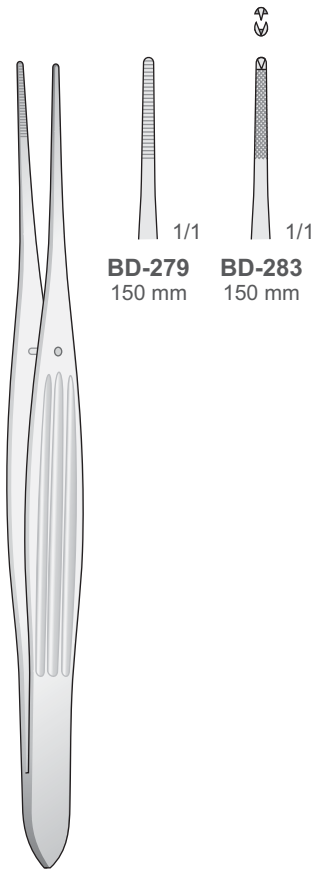

BD-279
150 mm

BD-283
150 mm

McINDOE
BD-279/BD-283
150 mm

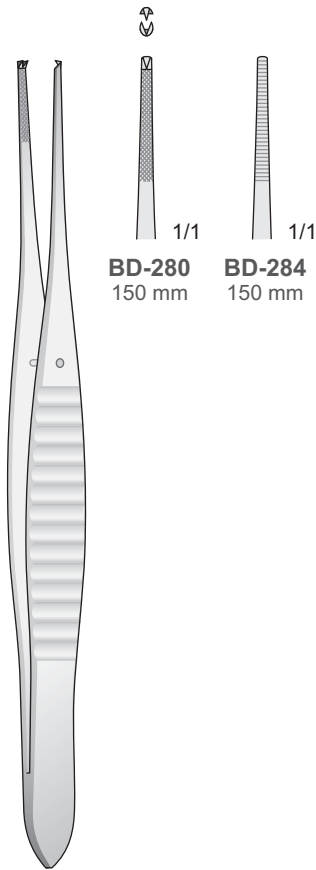

BD-280
150 mm

BD-284
150 mm

GILLIES
BD-280/BD-284
150 mm

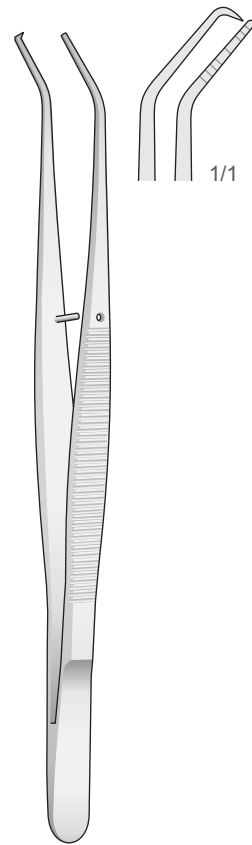

CRANE-CAPLAN
DB-01
150 mm

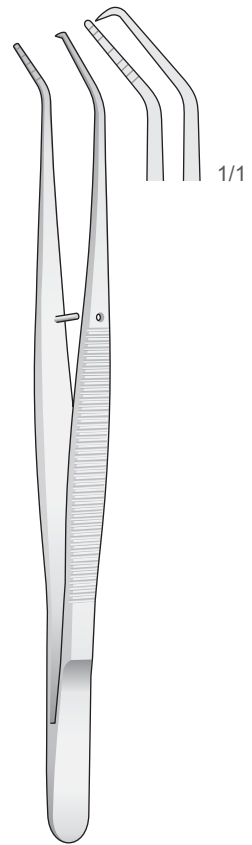

CRANE-CAPLAN
DB-02
150 mm



Chirurgische Pinzetten
Tissue Forceps
Pinzette chirurgiche
Pinzas quirúrgicas
Pinces chirurgicales

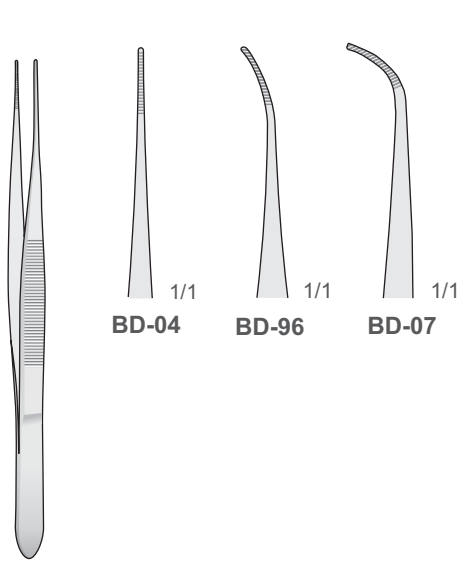

BD-04 1/1
BD-96 1/1
BD-07 1/1

GRAEFE
BD-04/BD-96
100 mm

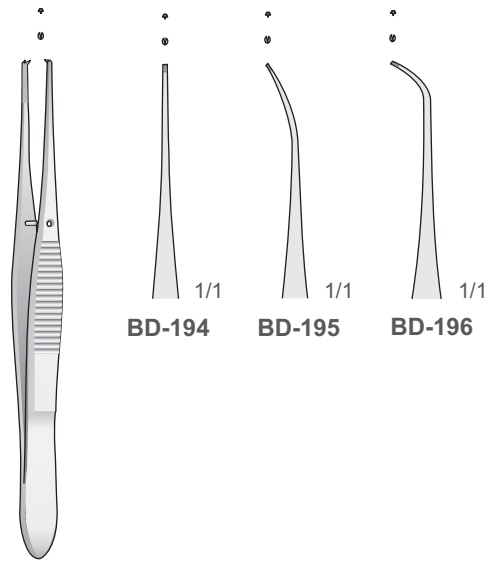

BD-194 1/1
BD-195 1/1
BD-196 1/1

GRAEFE
BD-194/BD-196
100 mm

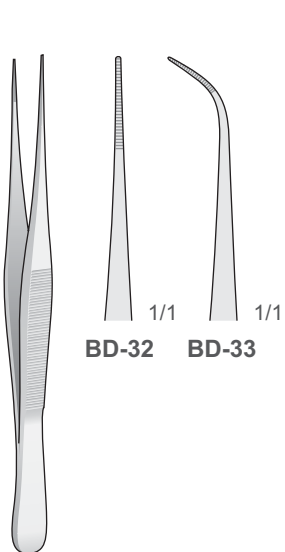

BD-32 1/1
BD-33 1/1

BD-32/BD-33
100 mm

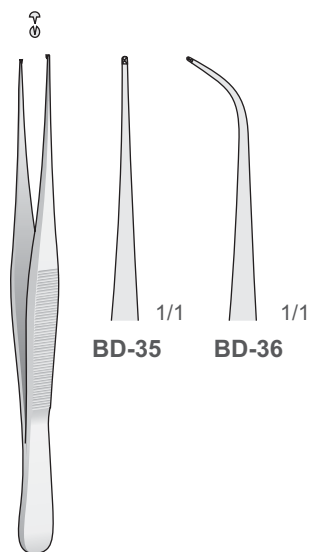

BD-35 1/1
BD-36 1/1

BD-35/BD-36
100 mm

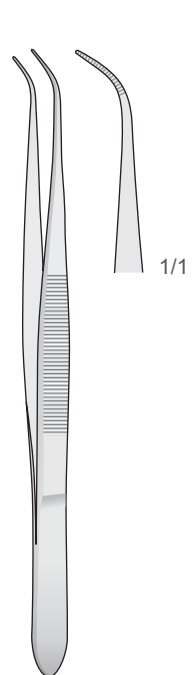

PERRY
BD-05
125 mm

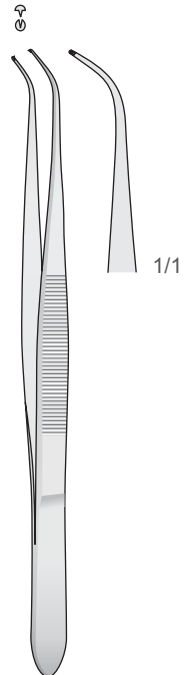

PERRY
BD-06
125 mm



Anatomische Pinzetten
Dressing Forceps
Pinzette anatomiche
Pinzas de diseccion
Pincas anatomiques

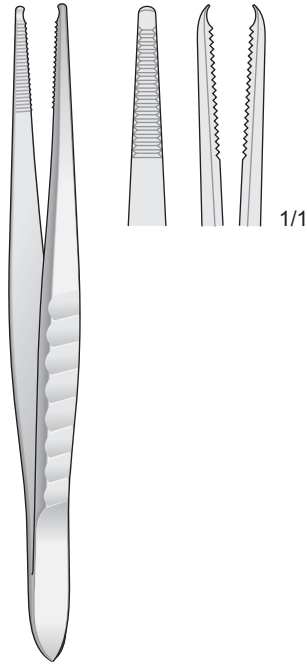

BD-270
130 mm

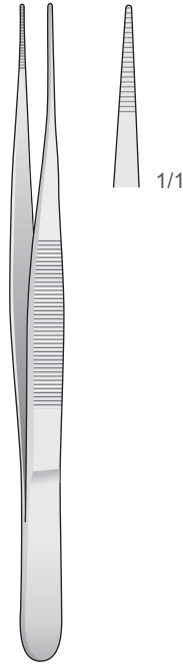

BD-145
130 mm

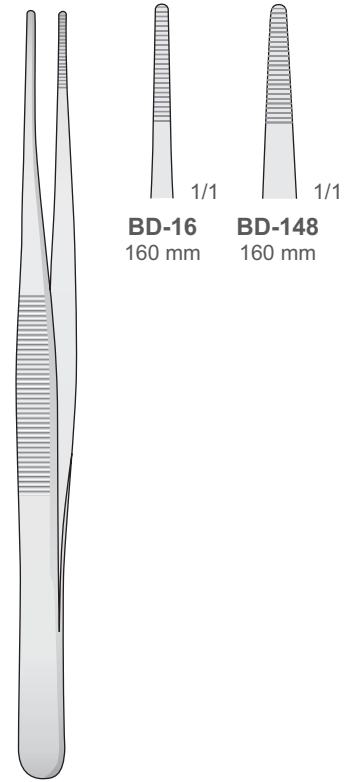

BD-16
160 mm

BD-148
160 mm

BD-16/BD-148
160 mm

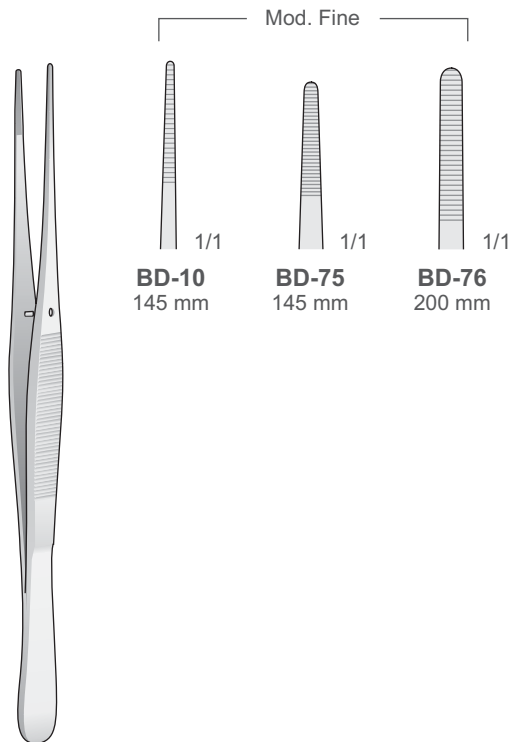

BD-10
145 mm

BD-75
145 mm

BD-76
200 mm

BD-10/BD-76

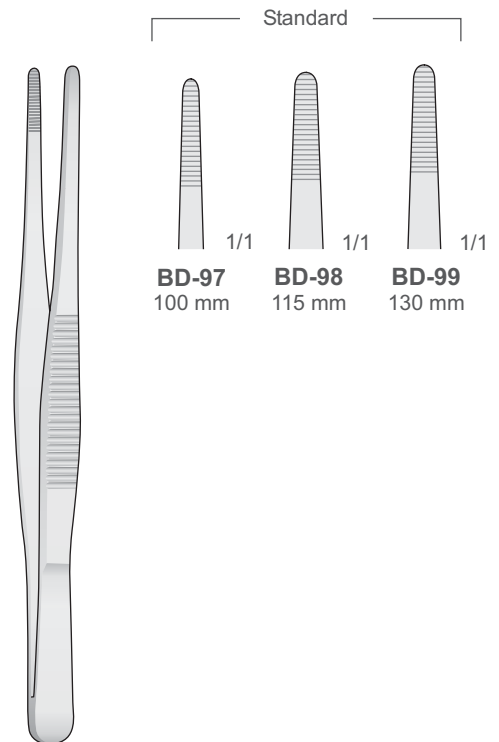

BD-97
100 mm

BD-98
115 mm

BD-99
130 mm

BD-97/BD-99



Chirurgische Pinzetten
Tissue Forceps
Pinzette chirurgiche
Pinzas quirúrgicas
Pincas quirúrgicas

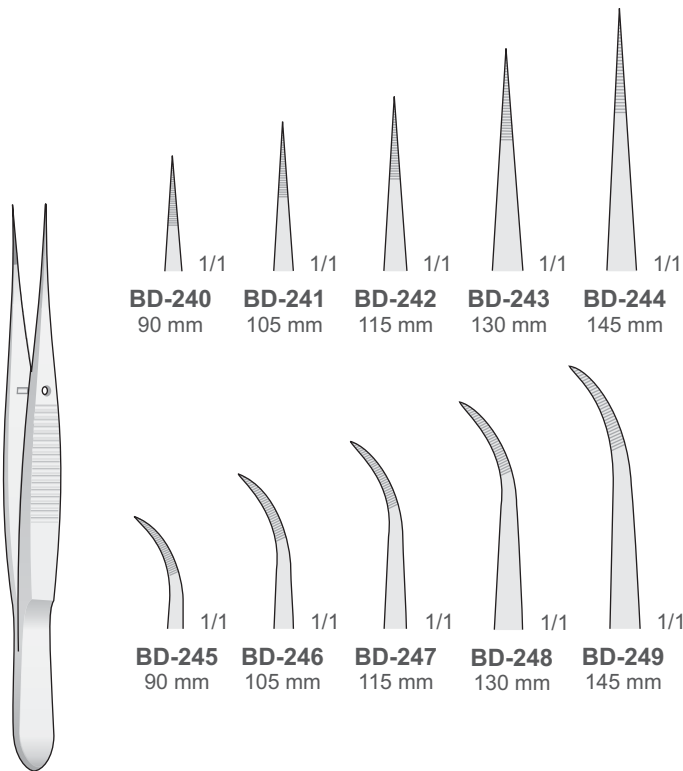

BD-240/BD-249

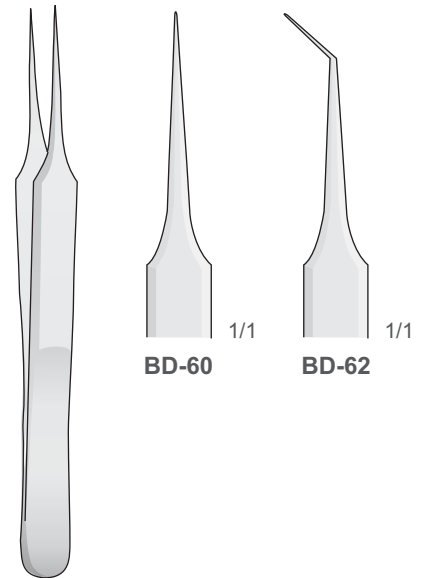

BD-60/BD-62
110 mm

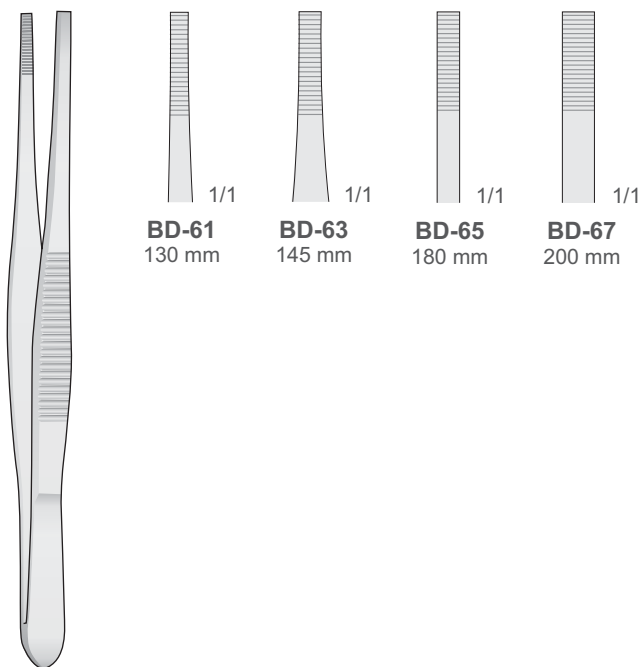

STILLE
BD-61/BD-67

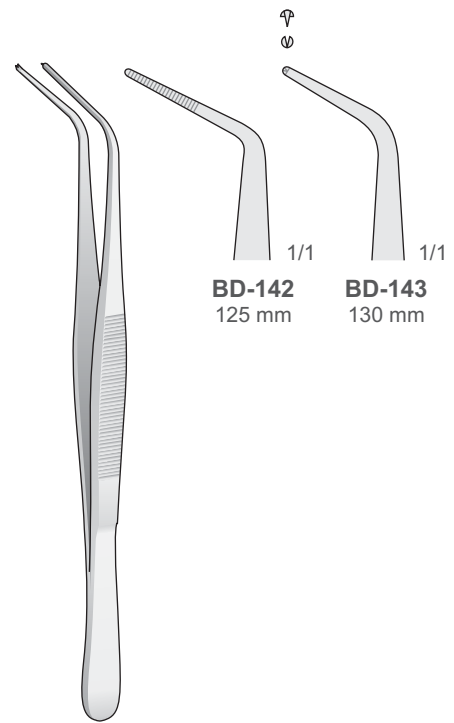

BD-142/BD-143



Chirurgische Pinzetten
Tissue Forceps
Pinzette chirurgiche
Pinzas quirúrgicas
Pincas quirúrgicas

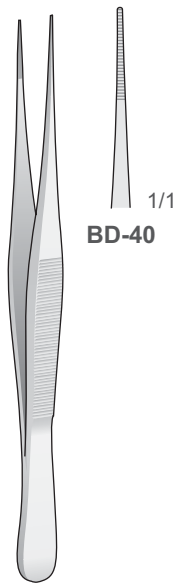

BD-40
110 mm

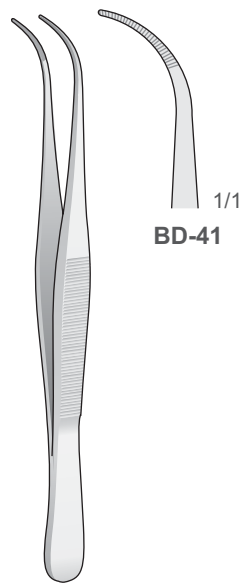

BD-41
110 mm

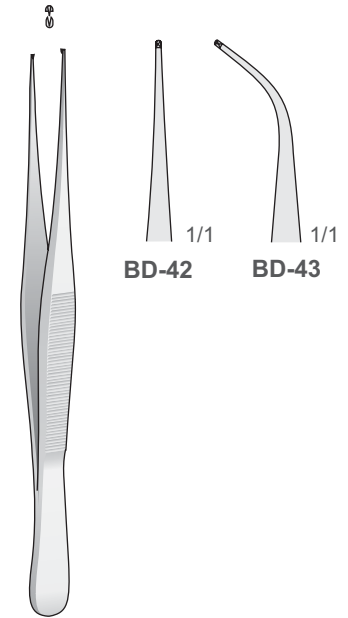

BD-42/BD-43
110 mm

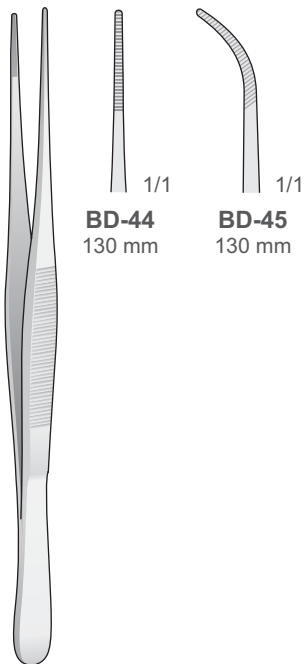

SEMKEN
BD-44/BD-45
130 mm

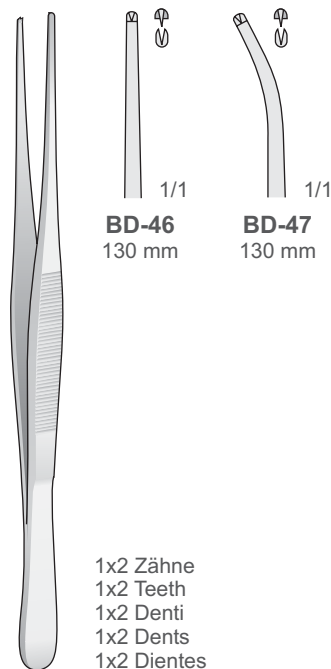

SEMKEN
BD-46/BD-47
130 mm

1x2 Zähne
1x2 Teeth
1x2 Denti
1x2 Dents
1x2 Dientes

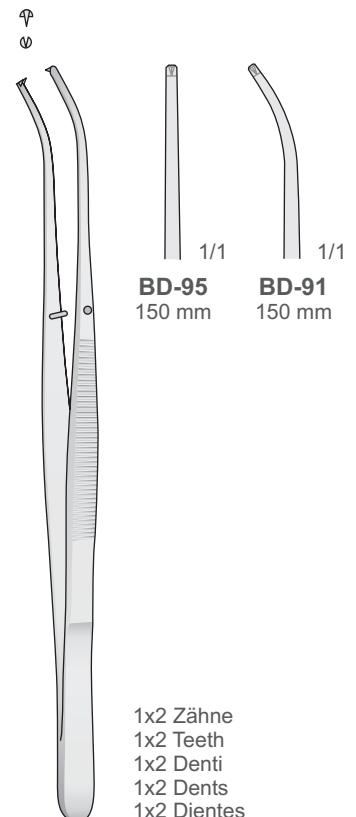

SEMKEN
BD-91/BD-95
150 mm

1x2 Zähne
1x2 Teeth
1x2 Denti
1x2 Dents
1x2 Dientes



Chirurgische Pinzetten
Tissue Forceps
Pinzette chirurgiche
Pinzas quirúrgicas
Pincas chirurgicales

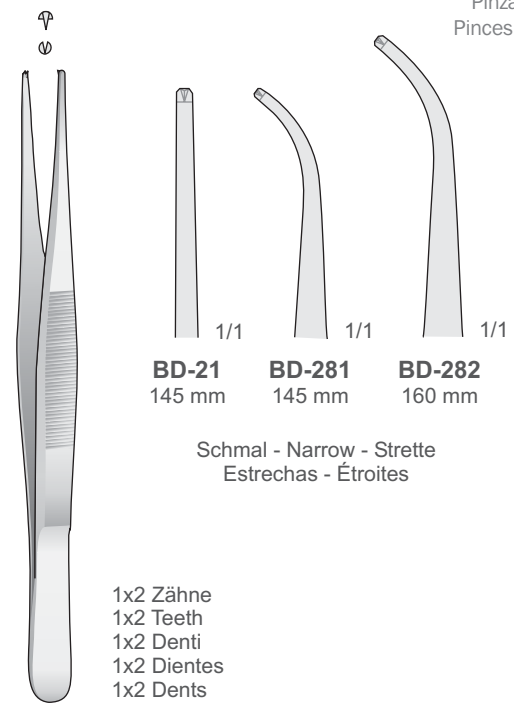
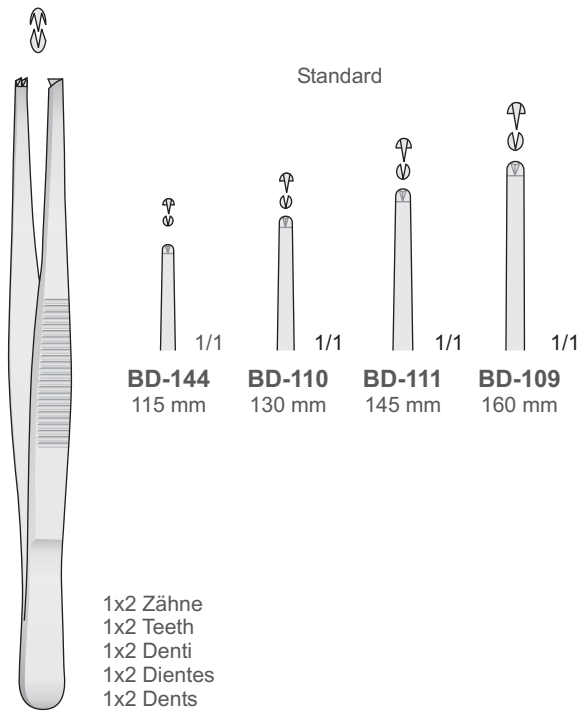

BD-109/BD-144

BD-21/BD-282

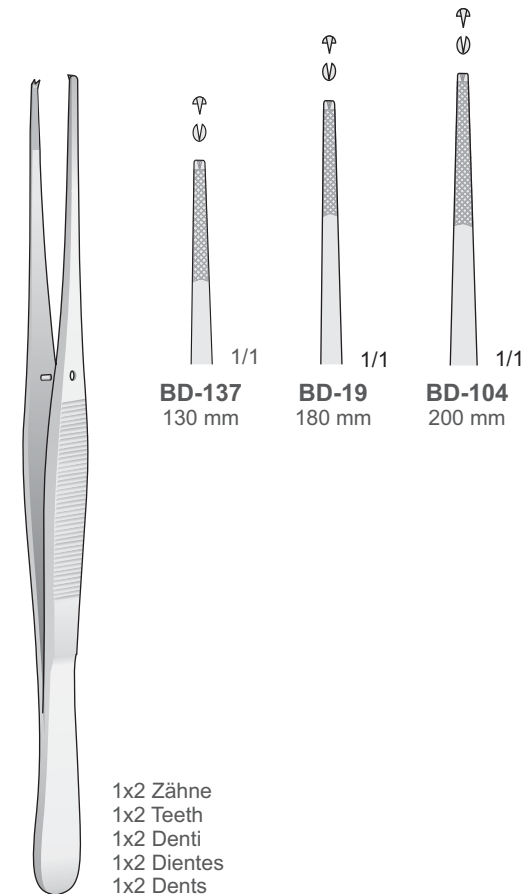
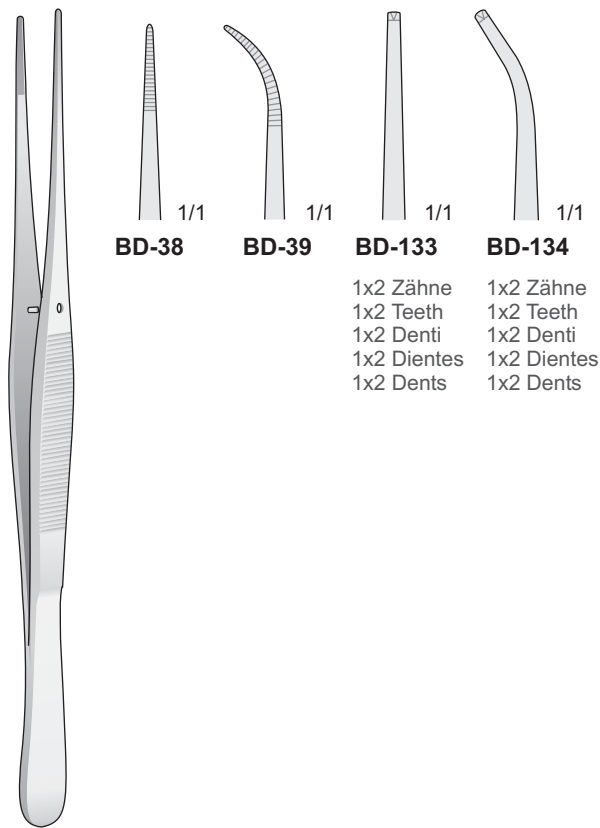

BD-38/BD-134
200 mm

BD-19/BD-137



Chirurgische Pinzetten
Tissue Forceps
Pinzette chirurgiche
Pinzas quirúrgicas
Pincas quirúrgicas

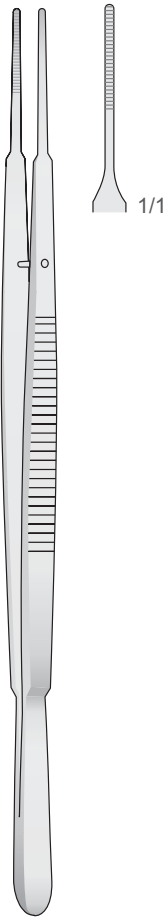

**GERALD
MF-101**
180 mm

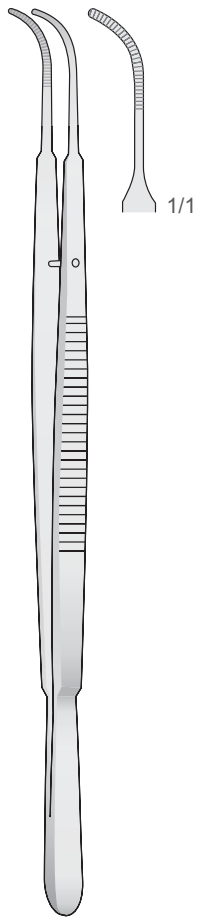

**GERALD
MF-102**
180 mm

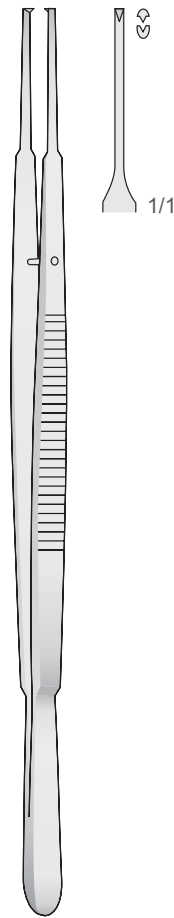

**GERALD
MF-103**
180 mm

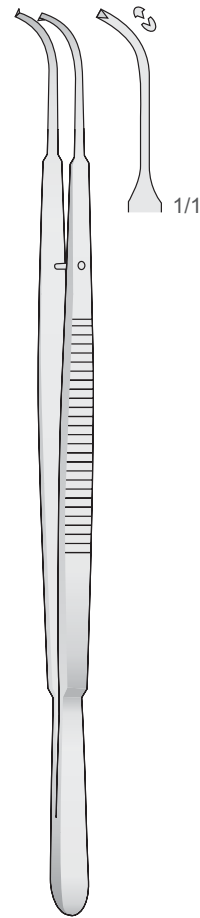

**GERALD
MF-104**
180 mm

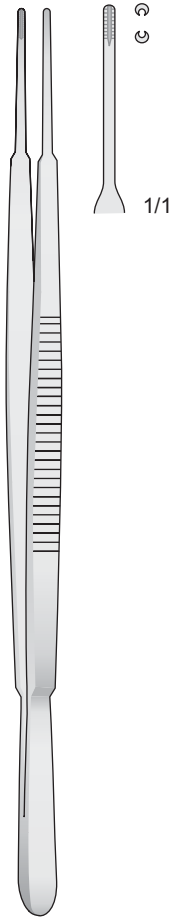

**GERALD-BROWN
MF-105**
180 mm



Chirurgische Pinzetten
Tissue Forceps
Pinzette chirurgiche
Pinzas quirúrgicas
Pincas chirurgicales

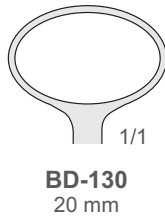
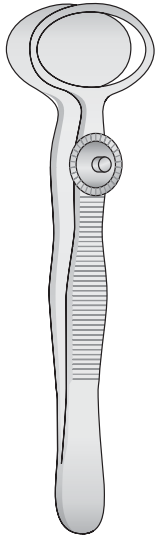

BD-130
20 mm

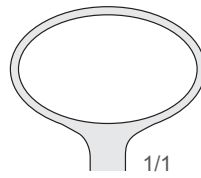

BD-131
26 mm

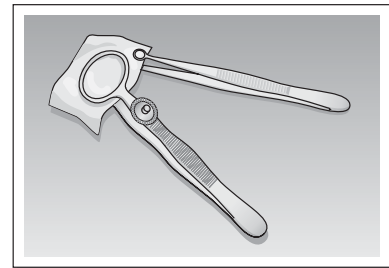

DESMARRES
BD-130/BD-131
90 mm

Pinzetten zum Halten Membranen
Membrane Holding forceps
Pinza per fissaggio membrane
Pinza para sostener membranas
Pince pour le maintien membranes

Membrane Forceps
with delicate Ring tip

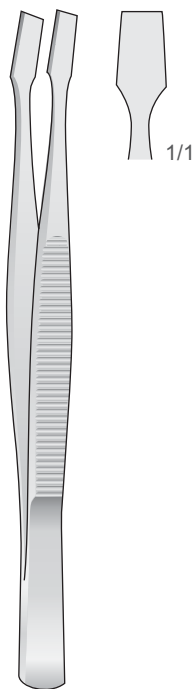

KÜHNE
ES-44
105 mm

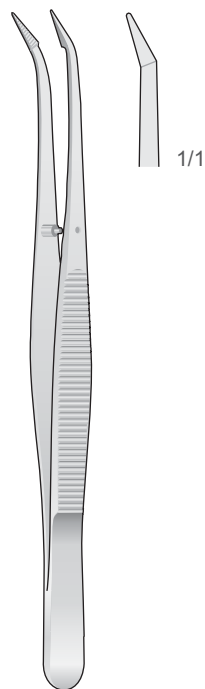

BARRAQUER
ES-65
105 mm



BD-56/BD-59
100 mm

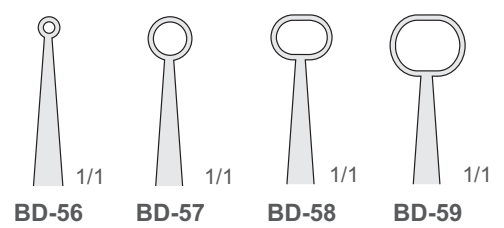



Chirurgische Pinzetten
Tissue Forceps
Pinzette chirurgiche
Pinzas chirùrgicas
Pincas chirurgicales

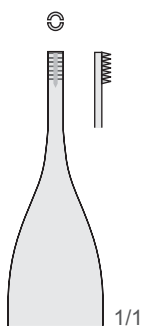
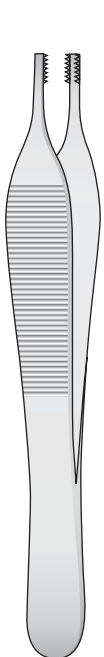

BD-92
120 mm

6x6 Zähne
6x6 Teeth
6x6 Denti
6x6 Dientes
6x6 Dents

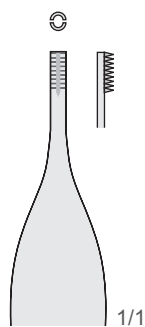

BD-141
120 mm

9x9 Zähne
9x9 Teeth
9x9 Denti
9x9 Dientes
9x9 Dents

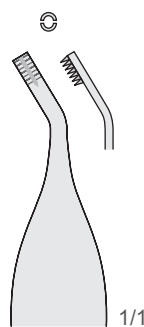

BD-93
120 mm

6x6 Zähne
6x6 Teeth
6x6 Denti
6x6 Dientes
6x6 Dents

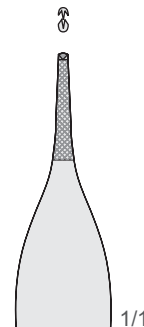

BD-90
120 mm

ADSON-BROWN
BD-92/BD-141
120 mm

ADSON
BD-90
120 mm

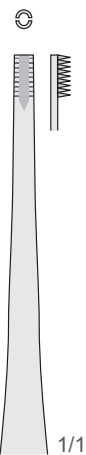

8x8 Zähne
8x8 Teeth
8x8 Denti
8x8 Dientes
8x8 Dents

BROWN
BD-94
150 mm

Standard

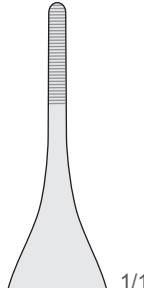

ADSON
BD-380
150 mm

Standard

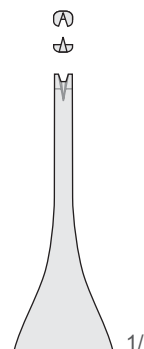

1x2 Zähne
1x2 Teeth
1x2 Denti
1x2 Dientes
1x2 Dents

ADSON
BD-381
150 mm

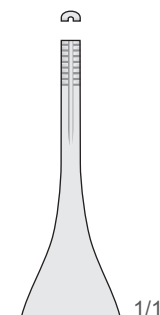

9x9 Zähne
9x9 Teeth
9x9 Denti
9x9 Dientes
9x9 Dents

ADSON-BROWN
BD-382
150 mm



Chirurgische Pinzetten
Tissue Forceps
Pinzette chirurgiche
Pinzas quirúrgicas
Pincas chirurgicales

1,0 mm

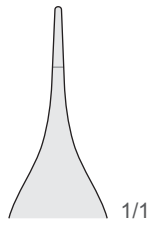

Mit Fadenplatte
With tying platform
Con piano prendifilo
Con plataforma
Avec plateaux pour monofil

ADSON
BD-370
120 mm

1,0 mm

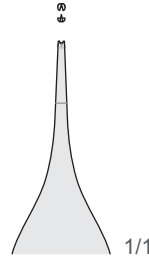

Mit Fadenplatte
With tying platform
Con piano prendifilo
Con plataforma
Avec plateaux pour monofil
1x2 Zähne
1x2 Teeth
1x2 Denti
1x2 Dientes
1x2 Dents

ADSON
BD-371
120 mm

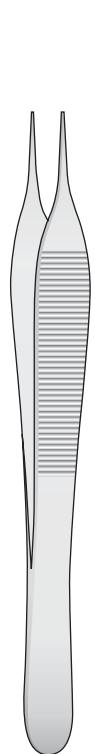

ADSON
BD-30/BD-73

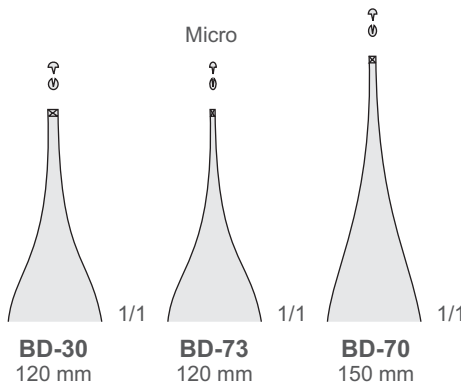

BD-30
120 mm

BD-73
120 mm

BD-70
150 mm

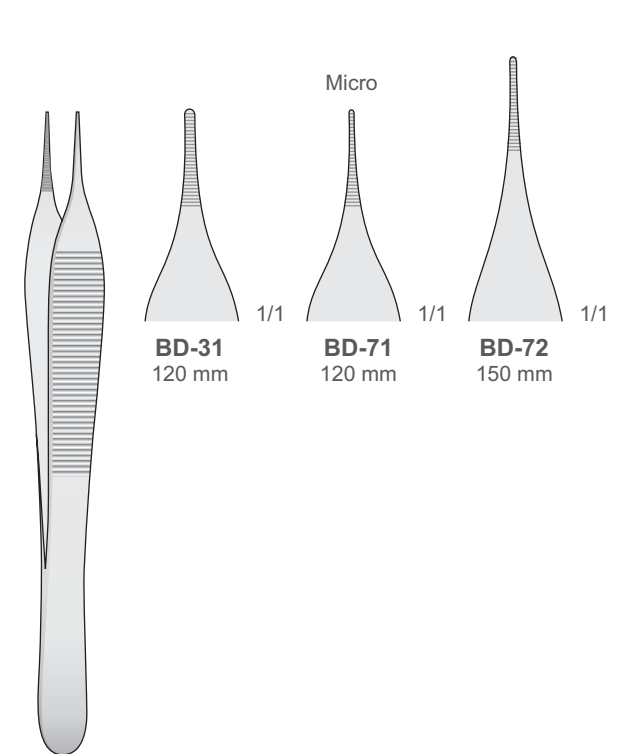

ADSON
BD-31/BD-72

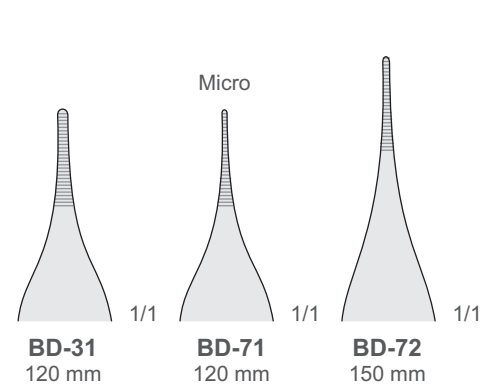

BD-31
120 mm

BD-71
120 mm

BD-72
150 mm



Chirurgische Pinzetten - Anatomische Pinzetten
Tissue Forceps - Dressing forceps
Pinzette chirurgiche - Pinzette anatomiche
Pinzas quirúrgicas - Pinzas de disección
Pincas quirúrgicas - Pincas anatómicas

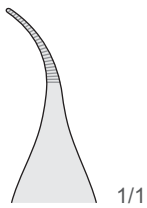

Extra fein
Extra fine
Extra fine
Extra finas
Extra fins

Gebogen
Curved
Curva
Curvas
Courbé

MICRO-ADSON
BD-372
120 mm

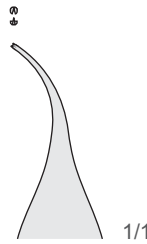

Extra fein
Extra fine
Extra fine
Extra finas
Extra fins

Gebogen
Curved
Curva
Curvas
Courbé

1x2 Zähne
1x2 Teeth
1x2 Denti
1x2 Dientes
1x2 Dents

MICRO-ADSON
BD-373
120 mm

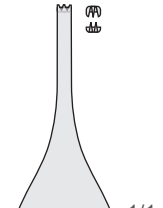

2x3 Zähne
2x3 Teeth
2x3 Denti
2x3 Dientes
2x3 Dents

ADSON
BD-377
120 mm

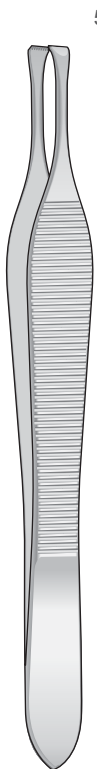

BEASLEY-BABCOCK
BD-51
120 mm



GRAEFE
BD-135
110 mm

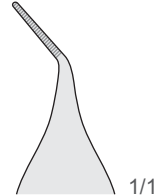

Gerieft
Serrated
Zigrinata
Estriada
Striée

Abgewinkelt
Angled
Angolata
Angulada
Coudée en haut

ADSON
BD-378
120 mm

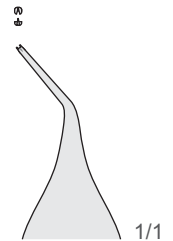

1x2 Zähne
1x2 Teeth
1x2 Denti
1x2 Dientes
1x2 Dents

Abgewinkelt
Angled
Angolata
Angulada
Coudée en haut

ADSON
BD-379
120 mm



Chirurgische Pinzetten - Anatomische Pinzetten
 Tissue Forceps - Dressing forceps
 Pinzette chirurgiche - Pinzette anatomiche
 Pinzas quirúrgicas - Pinzas de disección
 Pincas chirurgicales - Pincas anatómicas

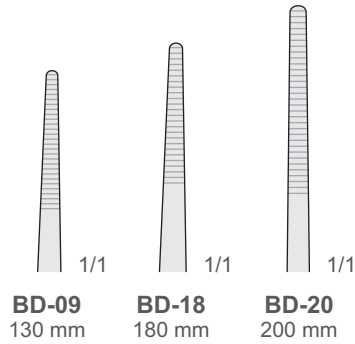

BD-09
130 mm

BD-18
180 mm

BD-20
200 mm

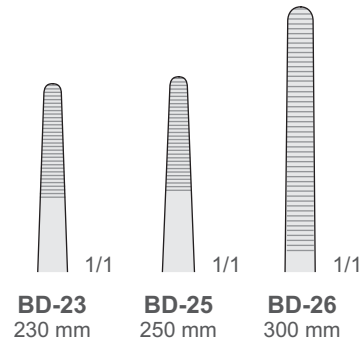

BD-23
230 mm

BD-25
250 mm

BD-26
300 mm

BD-09/BD-20

BD-23/BD-26

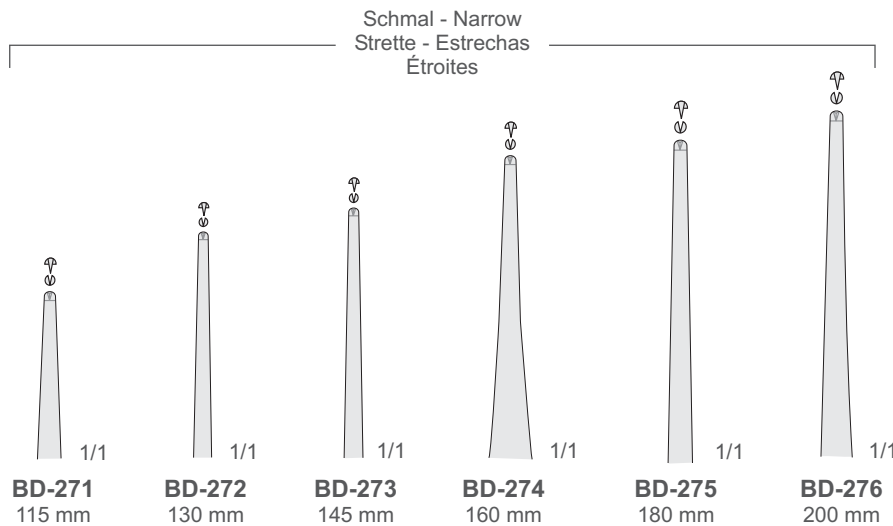

BD-271
115 mm

BD-272
130 mm

BD-273
145 mm

BD-274
160 mm

BD-275
180 mm

BD-276
200 mm

1x2 Zähne
 1x2 Teeth
 1x2 Denti
 1x2 Dientes
 1x2 Dents

BD-271/BD-276



Chirurgische Pinzetten
Tissue Forceps
Pinzette chirurgiche
Pinzas quirúrgicas
Pincas quirúrgicas

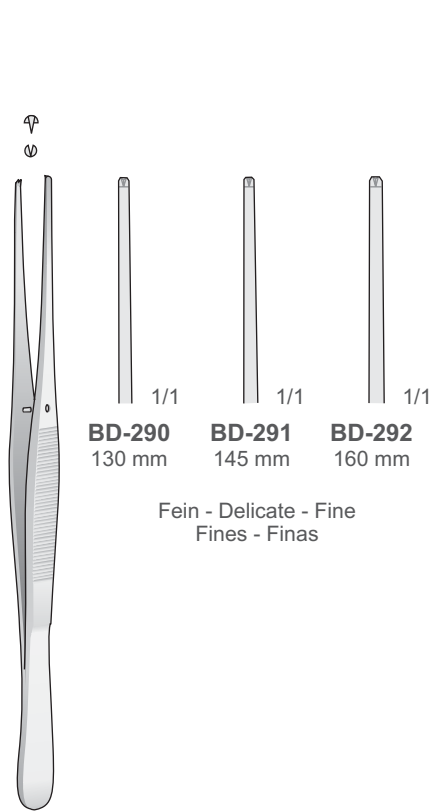

BD-290/BD-292

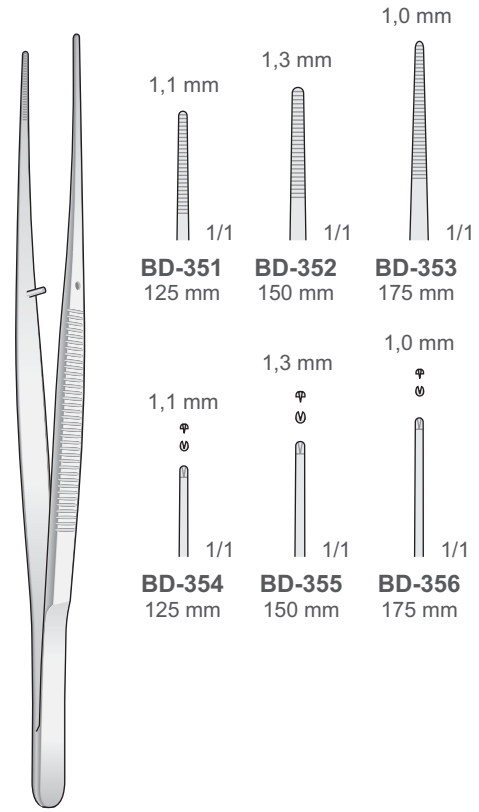

BD-351/BD-356

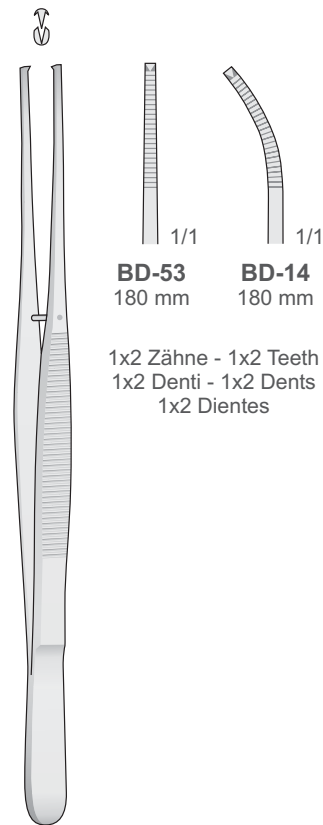

POTTS-SMITH
BD-14/BD-53
180 mm

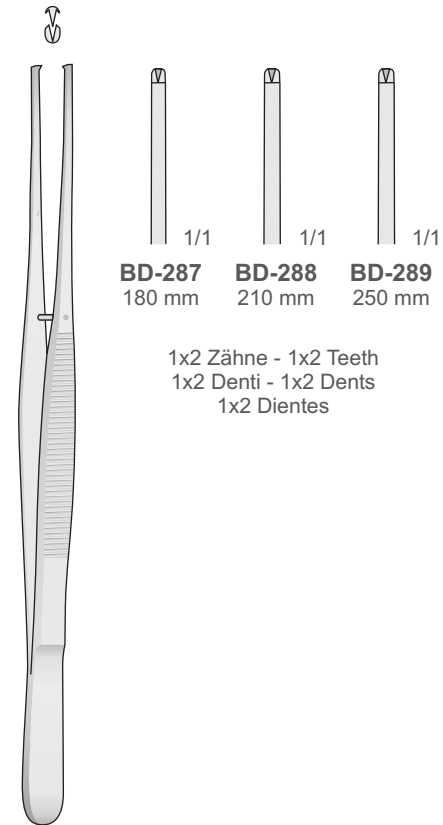

POTTS-SMITH
BD-287/BD-289



Chirurgische Pinzetten, Atraumatische Pinzetten
Tissue Forceps, Non-traumatic Forceps
Pinzette chirurgiche, Pinzette atraumatiche
Pinzas quirúrgicas, Pinzas atraumáticas
Pincas chirurgicales, Pincas atraumáticas

TC

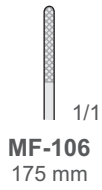

MF-106
175 mm



MF-107
175 mm

1x2 Zähne
1x2 Teeth
1x2 Denti
1x2 Dientes
1x2 Griffes

TC



1/1

GERALD
MF-106/MF-107
175 mm

WANGENSTEEN
BD-232
150 mm

Mit Hartmetalleinlage
With Tungsten-carbide inserts
Con inserti al carburo di tungsteno
Pinzas con plaquitas de carburo de tungsteno
Avec plaquettes en carbure de tungstène

TC

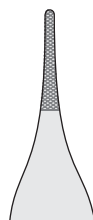
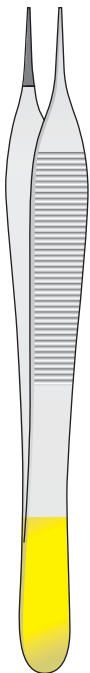

1/1

BD-230
120 mm

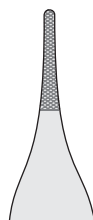

1/1

BD-231
150 mm

ADSON
BD-230/BD-231

TC

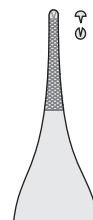
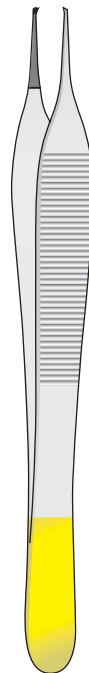

1/1

BD-250
120 mm

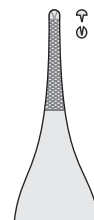

1/1

BD-251
150 mm

1x2 Zähne
1x2 Teeth
1x2 Denti
1x2 Dientes
1x2 Griffes

1x2 Zähne
1x2 Teeth
1x2 Denti
1x2 Dientes
1x2 Griffes

ADSON
BD-250/BD-251



Chirurgische Pinzetten, Atraumatische Pinzetten
Tissue Forceps, Non-traumatic Forceps
Pinzette chirurgiche, Pinzette atraumatiche
Pinzas quirùrgicas, Pinzas atraumáticas
Pincas chirurgicales, Pincas atraumatiques

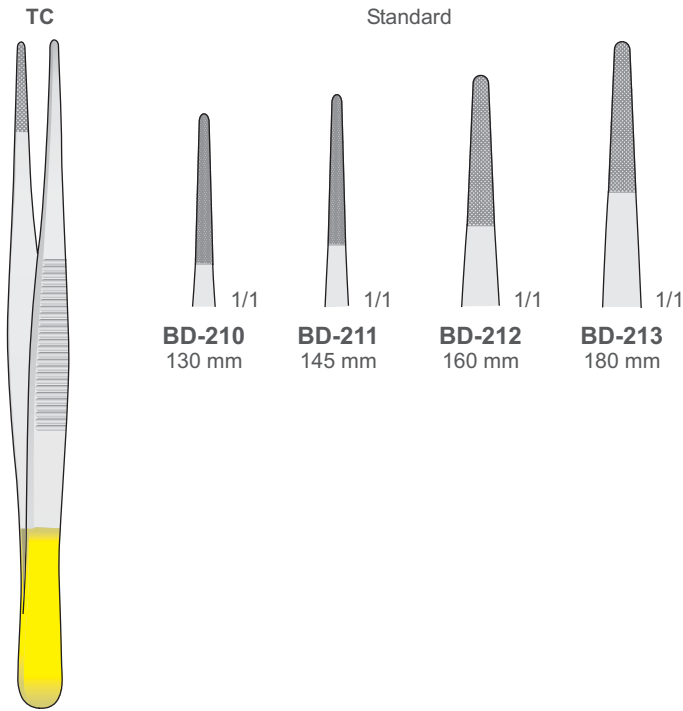

BD-210/BD-213

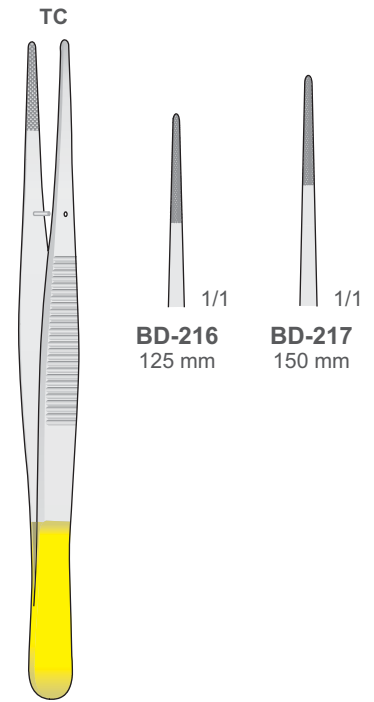

SEMKEN
BD-216/BD-217

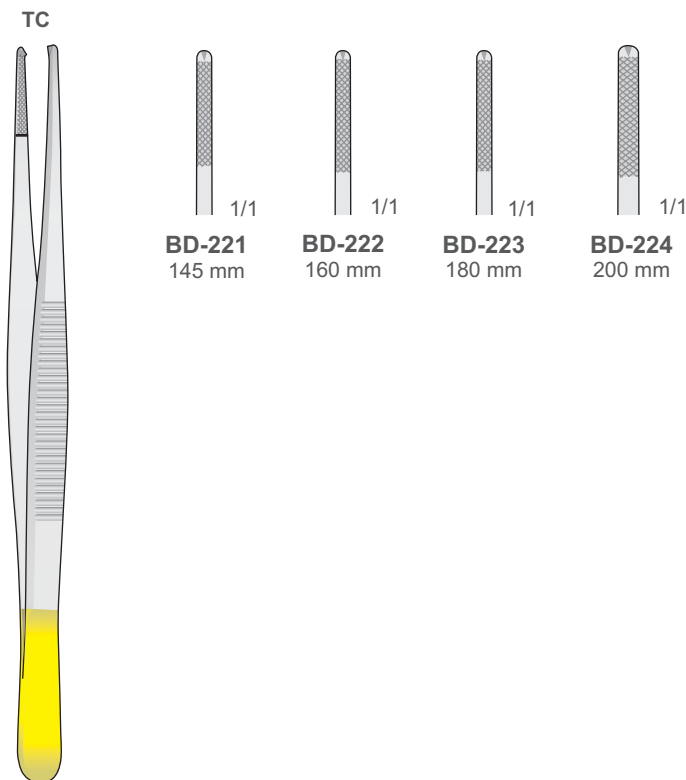

BD-221/BD-224

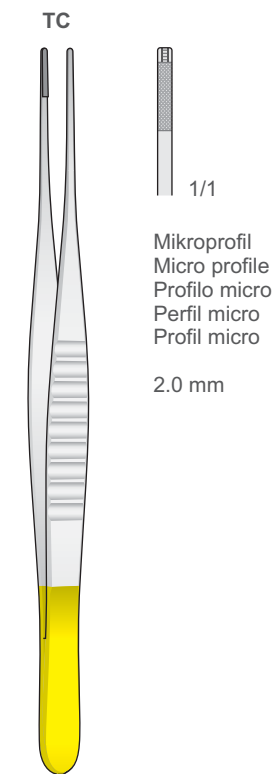

DE BAKEY
BD-267
160 mm



Pinzetten
Forceps
Pinzette
Pinzas
Pincers

Naht- und Membranpinzette - Suture and membrane Forceps
Pinzette per suture e membrane - Pinzas para suturas y membranas
Pincettes à suture et à membrane

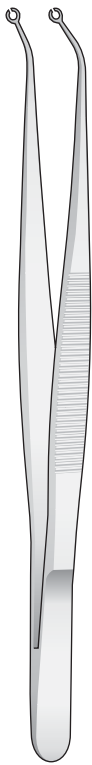

Ø Int 1.6 mm

1/1

BD-158

Ø Int 2.2 mm

1/1

BD-159

BD-158/BD-159
160 mm

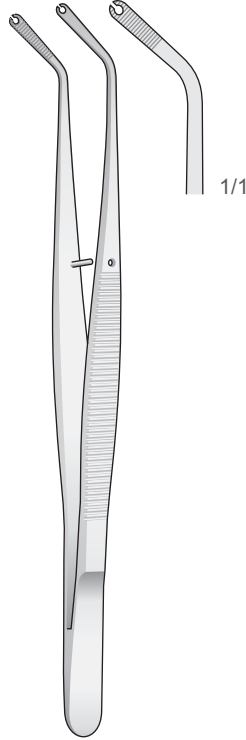

CORN DA-07
150 mm

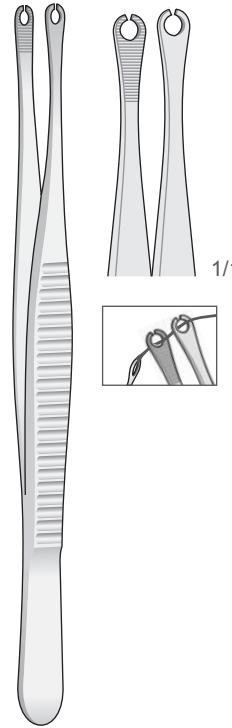

DA-06
150 mm

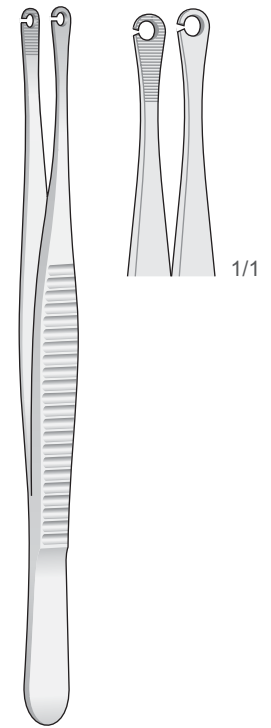

DA-08
150 mm

Artikulationspapier-Pinzetten - Articulating Paper Forceps
Pinza per carta articolazione - Pinzas para papel de articular
Pince pour papier à articuler



RUSSIAN BD-27/BD-175



BD-27
150 mm



BD-175
200 mm

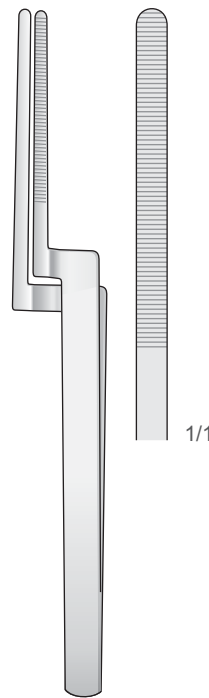

MILLER DR-78
145 mm

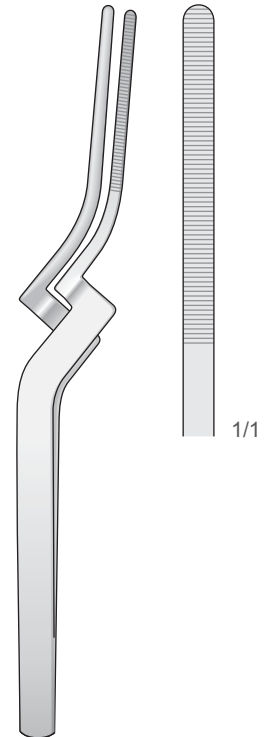

MILLER DR-80
160 mm

.6

Nadelhalter
Needle Holders
Port'aghi
Portaagujas
Porte aiguilles

Zahnärztliche Chirurgie
Dental surgery
Chirurgia dentale
Cirugia dental
Chirurgie dentaire

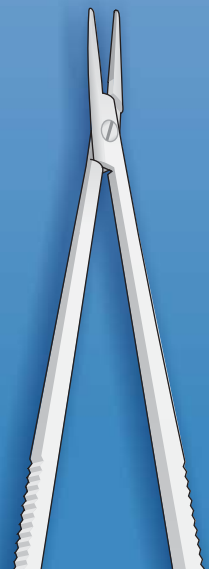

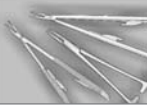

Nadelhalter
Needle Holders
Port'aghi
Portaagujas
Porte aiguilles

Mit Scheren
With Scissor
Con forbice
Con tijeras
Avec ciseaux

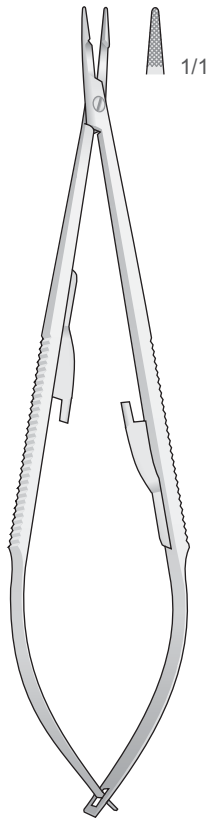

FD-26
140 mm



1/1

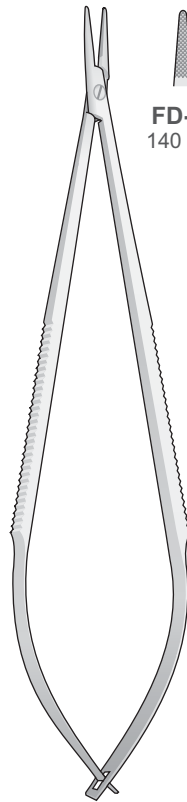

FD-14/FD-16
140 mm



1/1



1/1

FD-14
140 mm

FD-16
140 mm

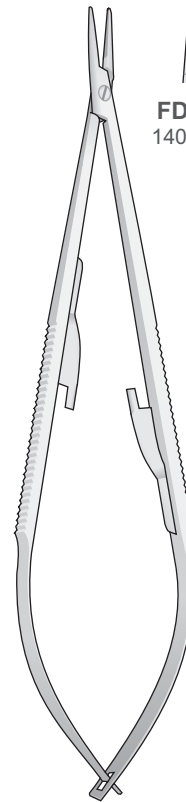

CASTROVIEJO
FD-17/FD-19
140 mm



1/1



1/1

FD-17
140 mm

FD-19
140 mm

Glattes Maul
Smooth jaws
Con morso liscio
Mandibula lisa
A' mors lisse



Nadelhalter
Needle Holders
Port'aghi
Portaagujas
Porte aiguilles

Mit Sperre - With Lock
Con arresto - Con cierre
Avec Arrêt

Glattes Maul
Smooth Jaw
Morso liscio
Boca lisa
Mors lisse

Feingerieftes Maul
Fine serrated jaws
Morso zigrinato fine
Bocas estriadas finas
Mors stries fins

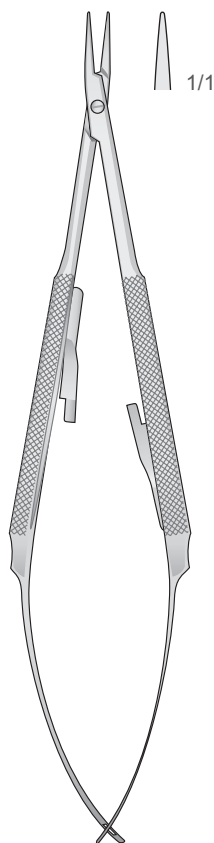

BARRAQUER
FD-216
150 mm

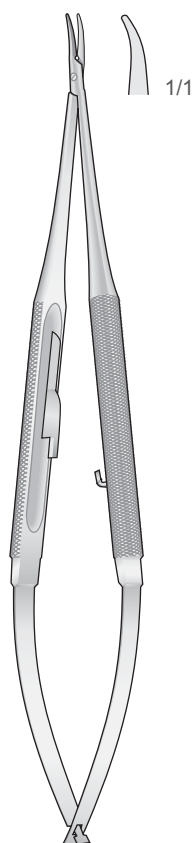

BARRAQUER
FD-217
150 mm

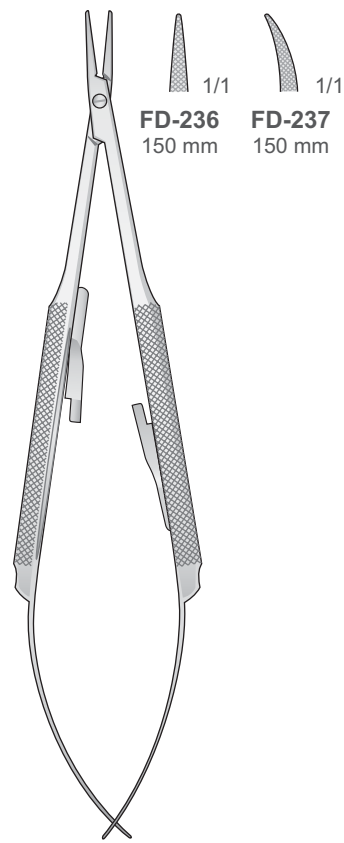

BARRAQUER
FD-236/FD-237
150 mm

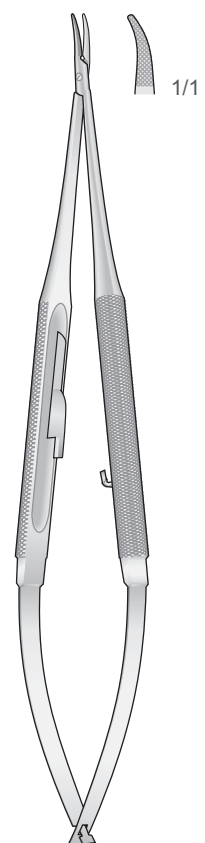

BARRAQUER
FD-24
150 mm



Nadelhalter mit Hartmetalleinlagen
Needle Holders with tungsten-carbide inserts
Portaghi con inserti al tungsteno
Portaagujas con plaquetas de carburo de tungsteno
Porte aiguilles avec plaquettes en carbure de tungstène

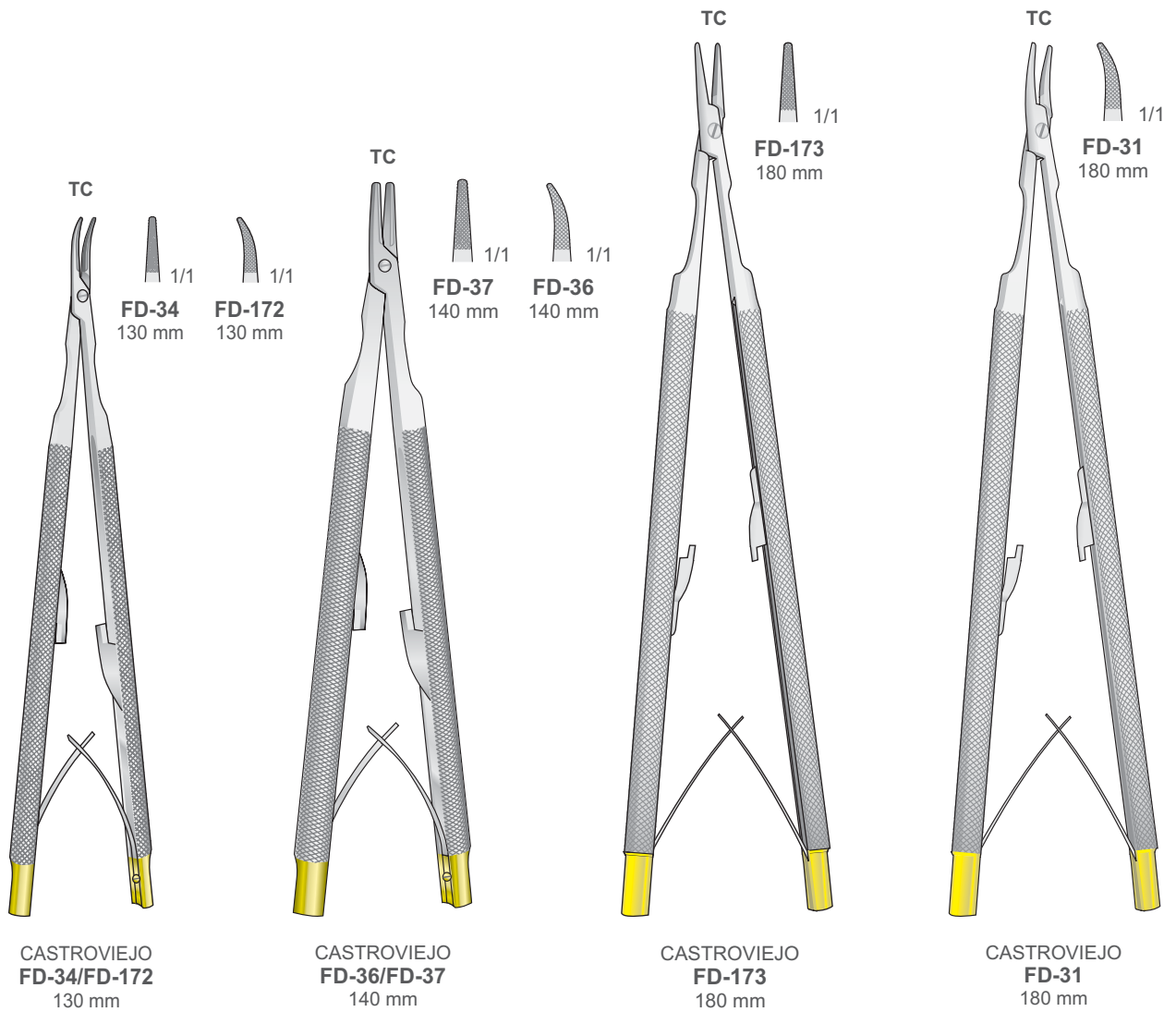



Nadelhalter mit Hartmetalleinlagen
Needle Holders with tungsten-carbide inserts
Portaghi con inserti al tungsteno
Portaagujas con plaquitas de carburo de tungsteno
Porte aiguilles avec plaquettes en carbure de tungstène

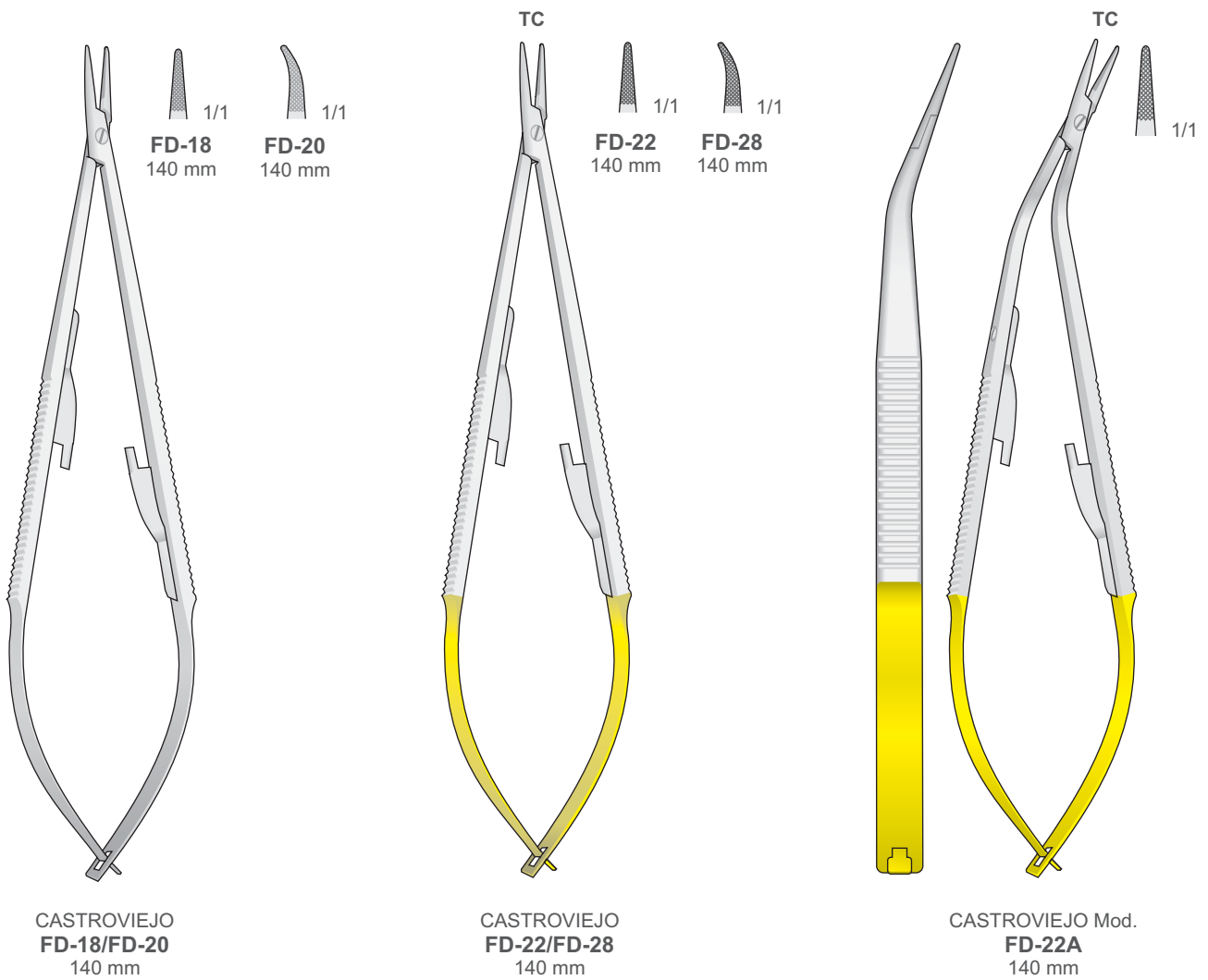



Nadelhalter mit Hartmetalleinlagen
Needle Holders with tungsten-carbide inserts
Portaghi con inserti al tungsteno
Portaagujas con plaquetas de carburo de tungsteno
Porte aiguilles avec plaquettes en tungstène

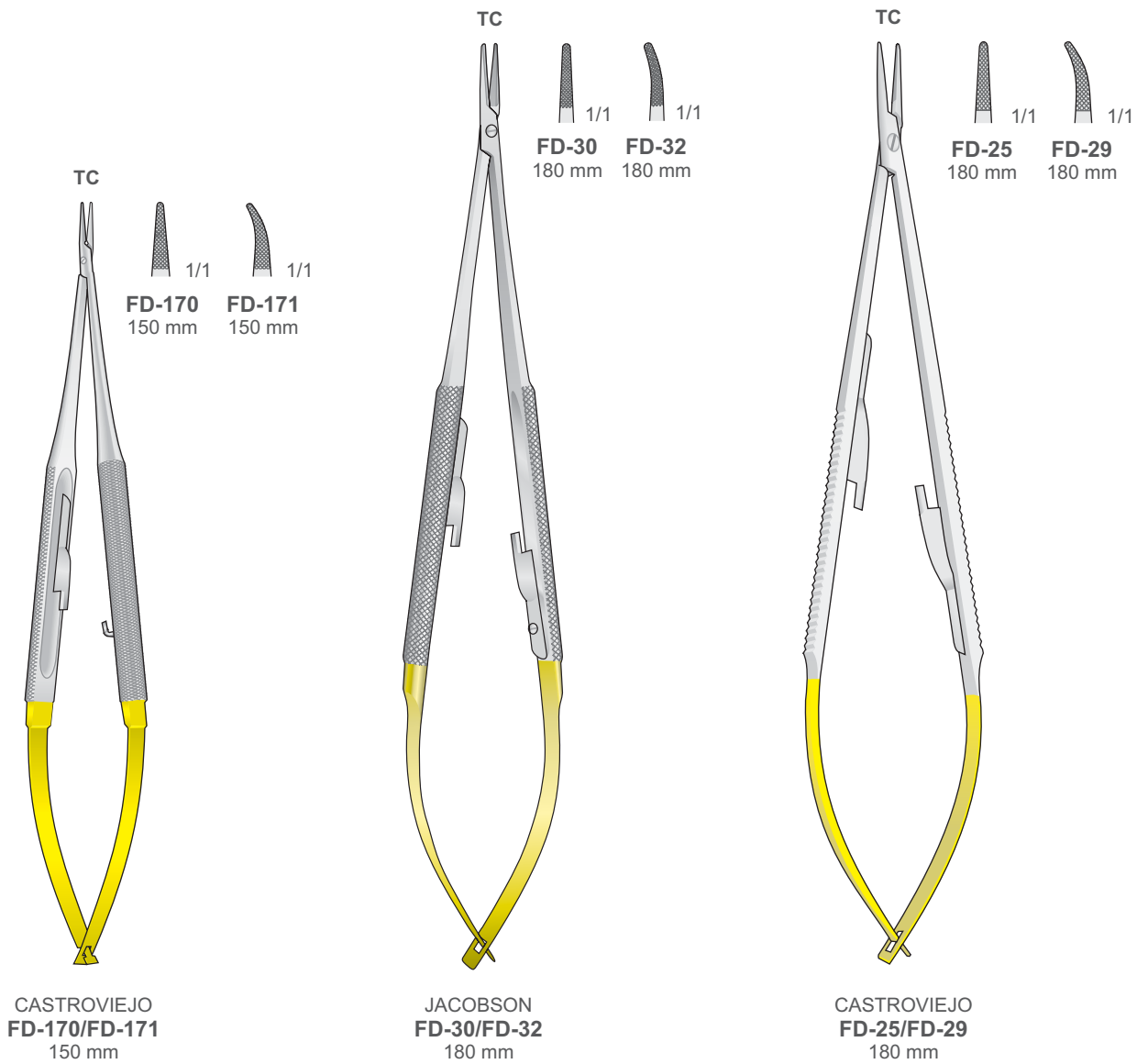



Nadelhalter
Needle Holders
Port'aghi
Portaagujas
Porte aiguilles

Nadelhalter mit Hartmetalleinlagen
Needle Holders with tungsten-carbide inserts
Portaghi con inserti al tungsteno
Portaagujas con plaquitas de carburo de tungsteno
Porte aiguilles avec plaquettes en carbure de tungstène

Diamantiert
Diamond Coated
Diamantati

Glattes Maul
Smooth jaws
Con morso liscio
Mandibula lisa
A' mors lisse

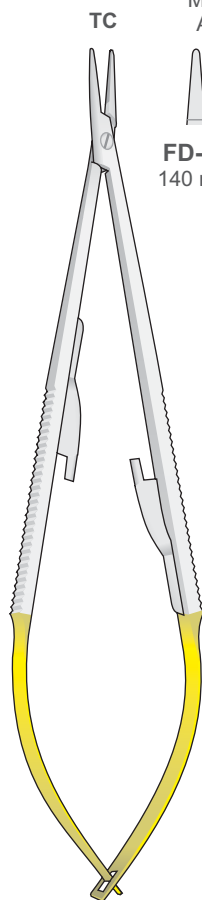

CASTROVIEJO
FD-21/FD-23
140 mm

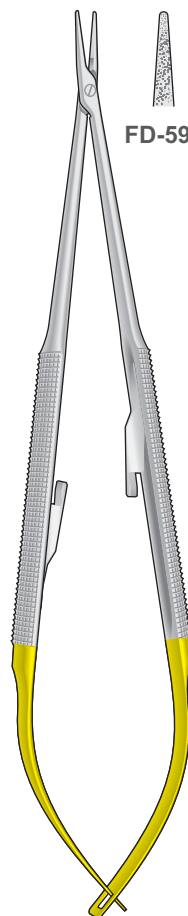
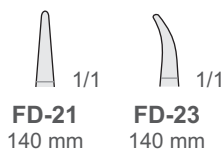

FD-599/FD-600
150 mm

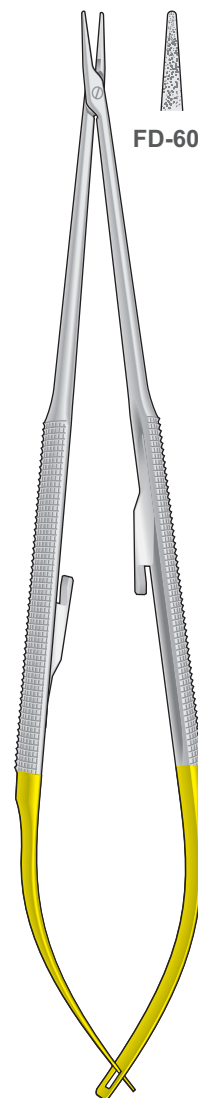

FD-601/FD-602
180 mm



Mikro Nadelhalter - Mikro Scheren
 Micro Needle Holders - Micro Scissors
 Micro Port'aghi - Micro Forbici
 Micro Portaagujas - Micro Tijeras
 Micro Porte aiguilles - Micro Ciseaux

Titan - Titanium - Titanio - Titane

Rund-Griffe Ø 8 mm
 Round handle Ø 8 mm
 Manico rotondo Ø 8 mm
 Mango redondo Ø 8 mm
 Manche rond Ø 8 mm

Mikro Nadelhalter
 Micro Needle Holders
 Micro port'aghi
 Micro portaagujas
 Micro porte aiguilles

Mikro Scheren
 Micro Scissors
 Micro forbici
 Micro tijeras
 Micro ciseaux

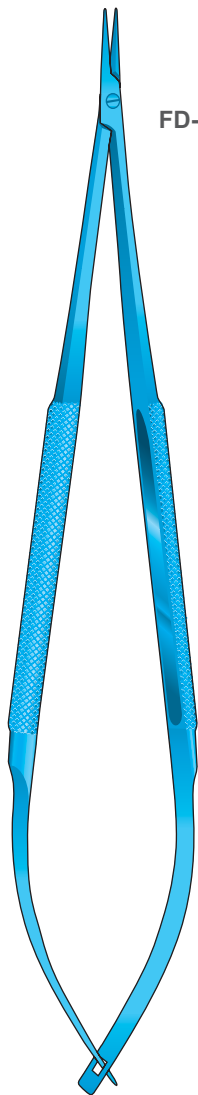

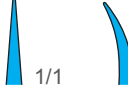
 1/1 1/1
FD-562T FD-563T

FD-562T/FD-563T
180 mm

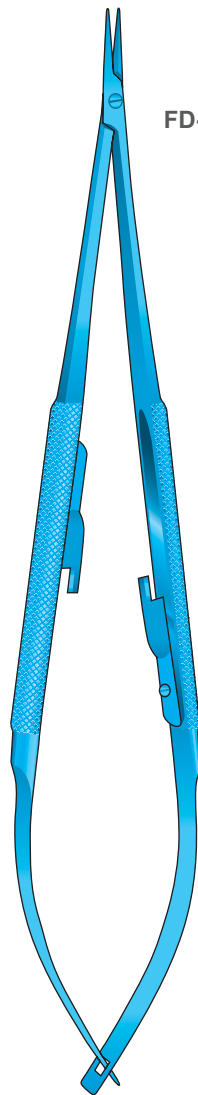



 1/1 1/1
FD-574T FD-575T

Mit Sperre
 With Lock
 Con arresto
 Con cierre
 Avec Arrêt

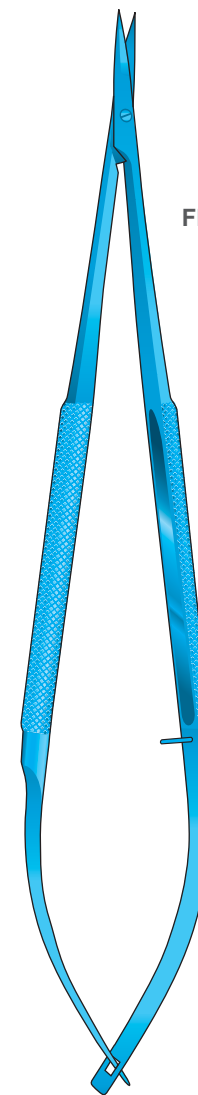
FD-574T/FD-575T
180 mm





 1/1 1/1
FD-587T FD-588T

FD-587T/FD-588T
180 mm

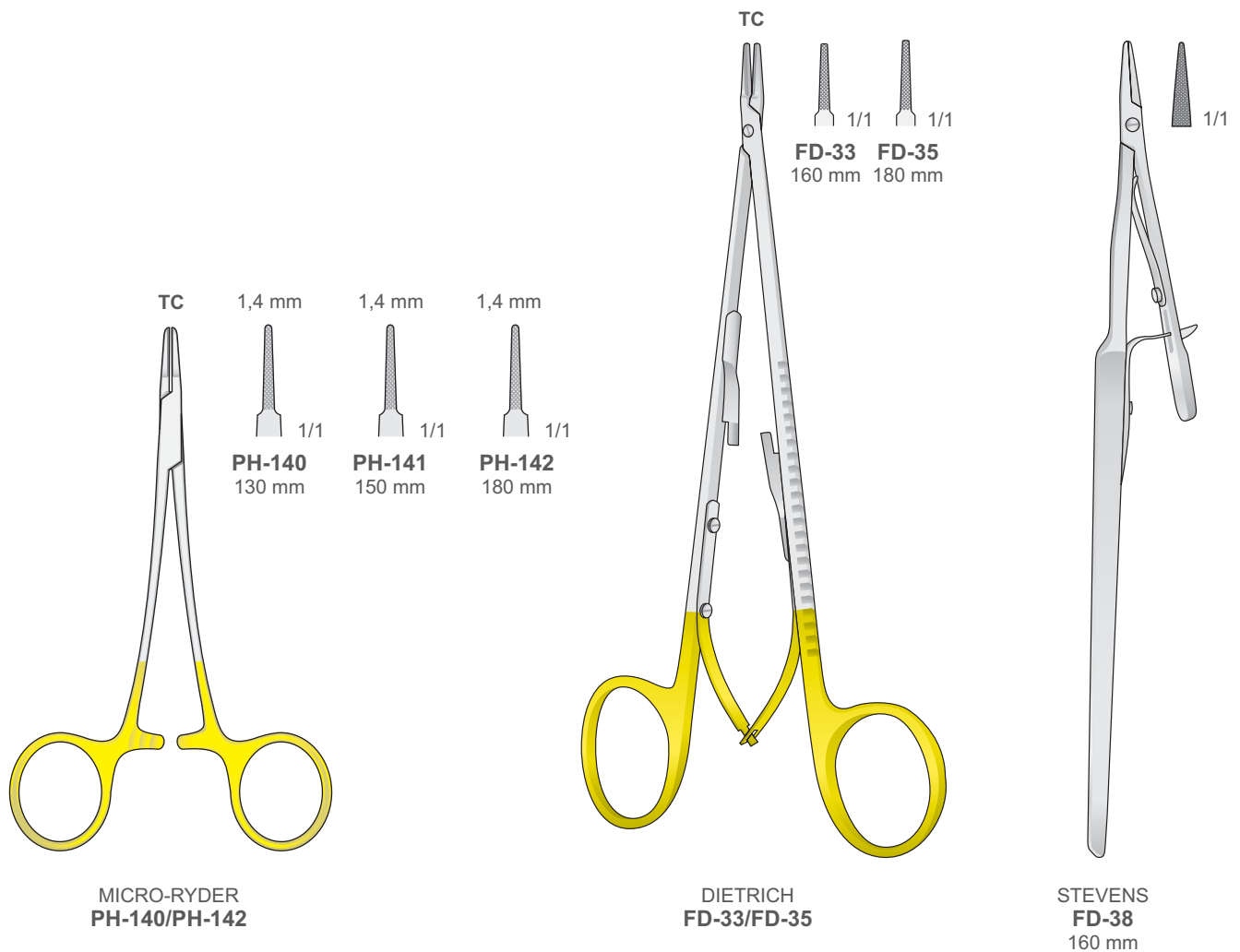

Nadelhalter
Needle Holders
Port'aghi
Portaagujas
Porte aiguilles

Nadelhalter mit Hartmetalleinlagen
Needle Holders with tungsten-carbide inserts
Portaghi con inserti al tungsteno
Portaagujas con plaquitas de carburo de tungsteno
Porte aiguilles avec plaquettes en carbure de tungstène



Nadelhalter
Needle Holders
Port'aghi
Portaagujas
Porte aiguilles

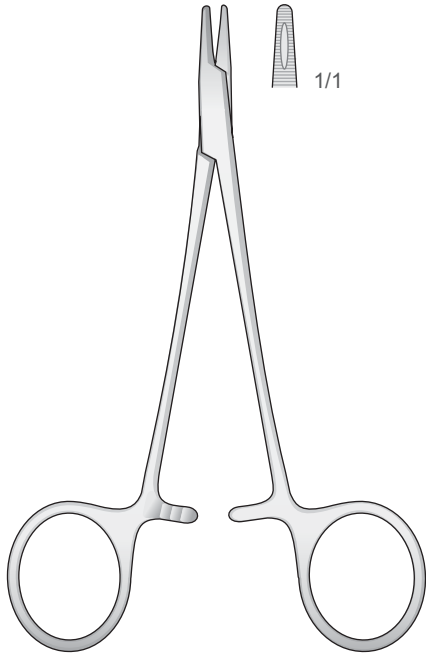

**DERF
PH-39**
125 mm

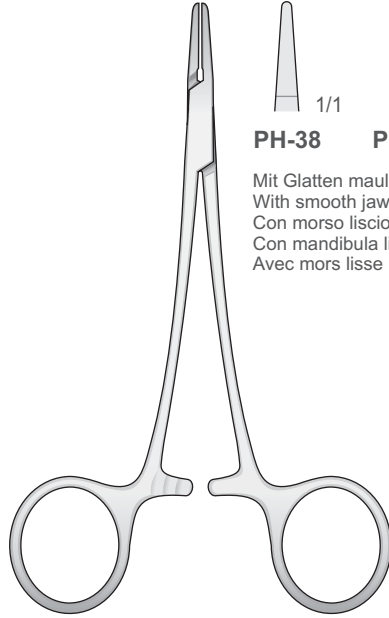

PH-38/PH-64
120 mm

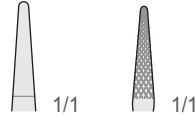

PH-38 PH-64
Mit Glatten maul
With smooth jaws
Con morso liscio
Con mandibula lisa
Avec mors lisse

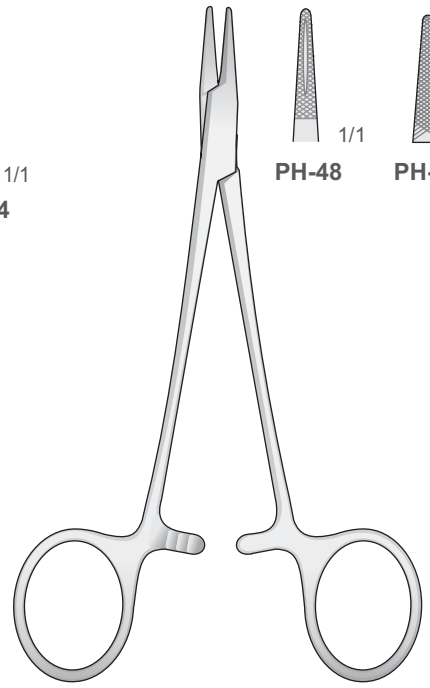

**HALSEY
PH-48/PH-63**
130 mm

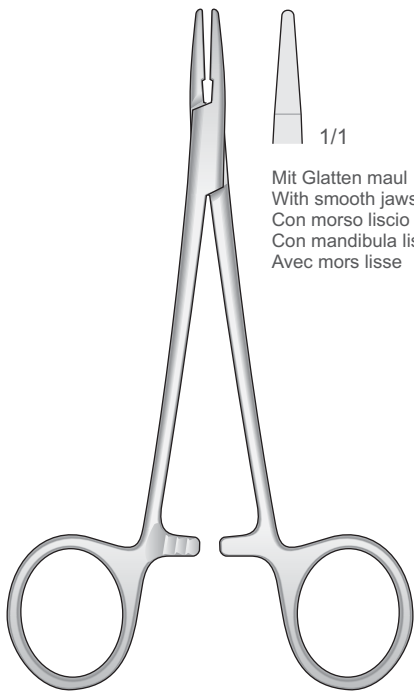
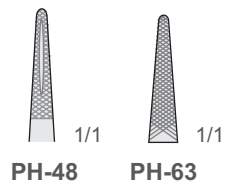

**HALSEY
PH-37**
130 mm

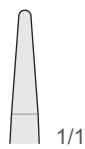

Mit Glatten maul
With smooth jaws
Con morso liscio
Con mandibula lisa
Avec mors lisse

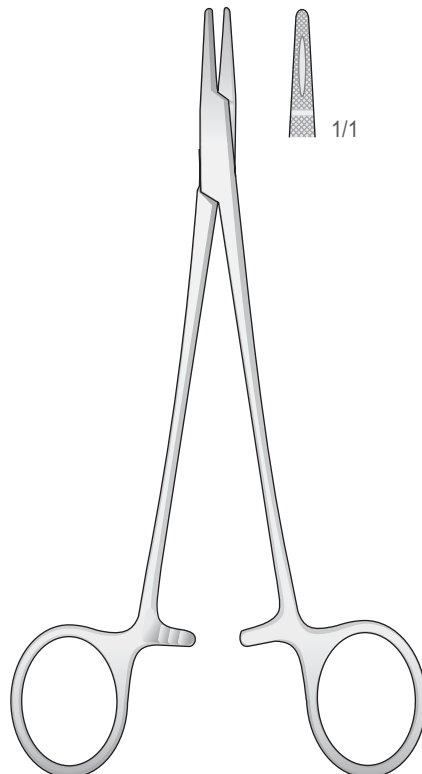

**CRILE-WOOD
PH-61**
150 mm

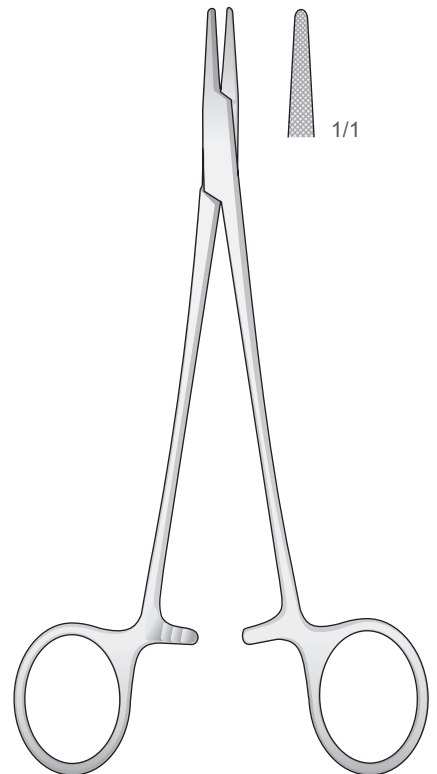
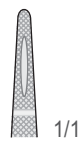

**CRILE-MURRAY
PH-62**
150 mm

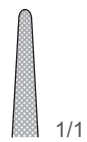



Nadelhalter
Needle Holders
Port'aghi
Portaagujas
Porte aiguilles

Nadelhalter mit Schere - Needle holders with scissors
Port'aghi con forbici - Portaagujas con tijeras
Porte aiguilles avec ciseaux

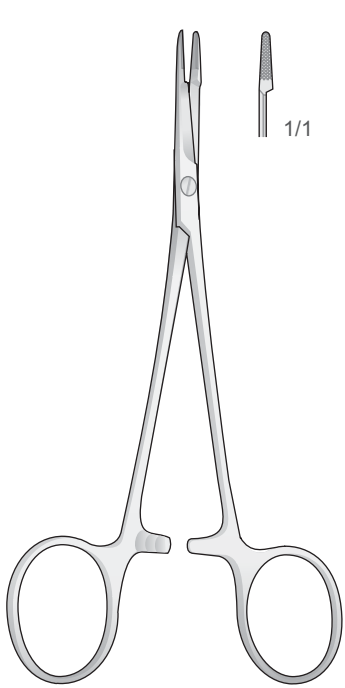

MINI-OLSEN-HEGAR
BM-61
120 mm

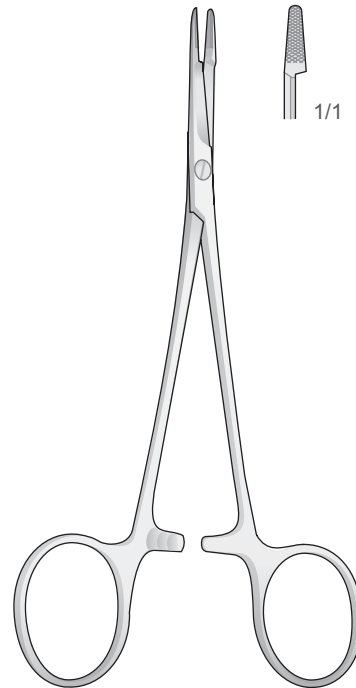

OLSEN-HEGAR
BM-62
140 mm

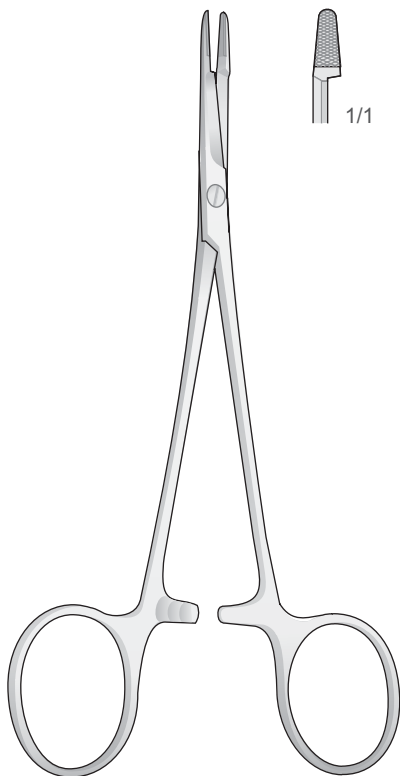

OLSEN-HEGAR
BM-63
170 mm

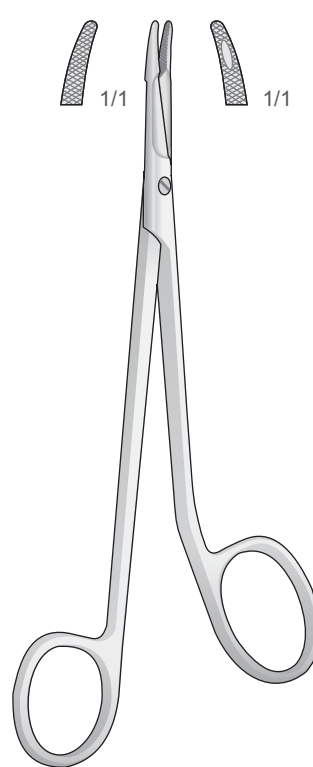

MINI-GILLIES
PO-59
145 mm

Nadelhalter
Needle Holders
Port'aghi
Portaagujas
Porte aiguilles

Nadelhalter mit Hartmetalleinlagen
Needle holders with tungste-carbide inserts
Portaghi con inserti al tungsteno
Portaagujas con plaquitas de carburo de tungsteno
Porte-aiguilles avec plaquettes en carbure de tungstène

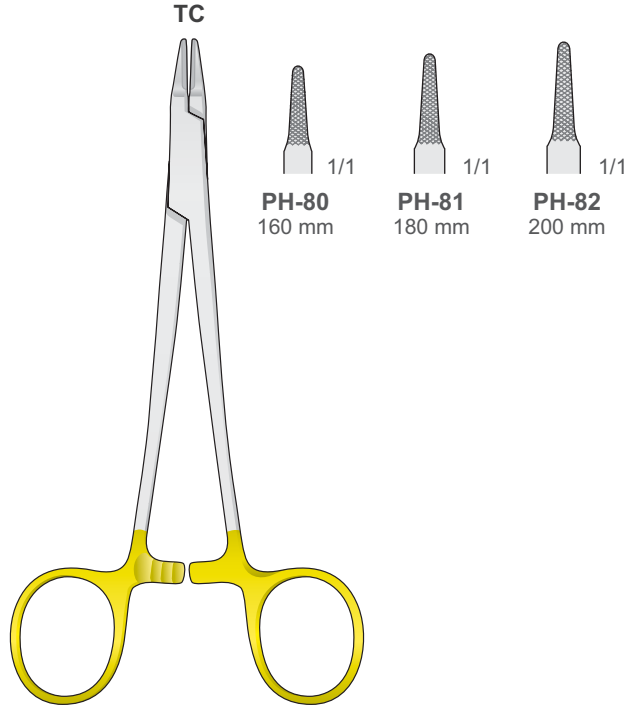

RYDER
PH-80/PH-82

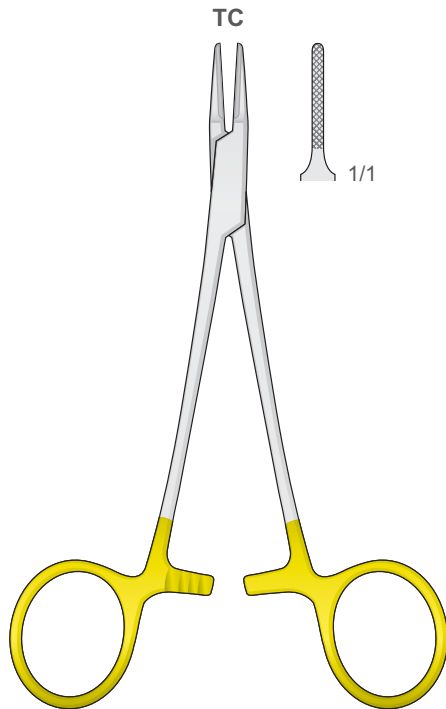

RYDER
PH-83
140 mm

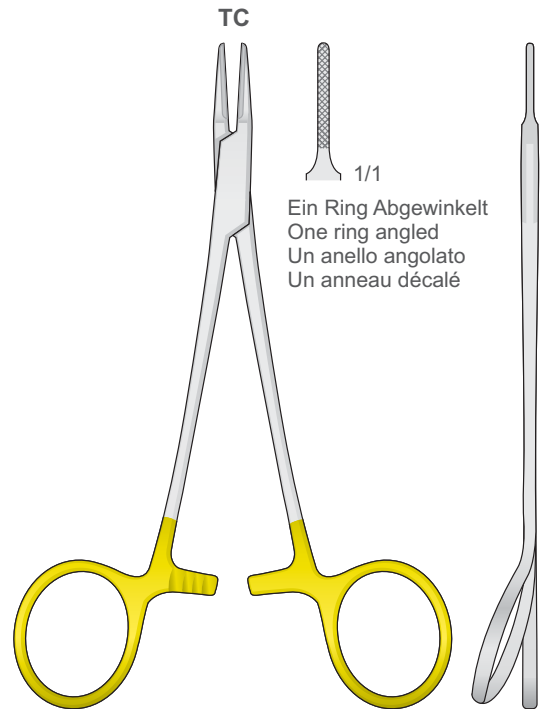

PH-84
140 mm



Nadelhalter
Needle Holders
Port'aghi
Portaagujas
Porte aiguilles

Nadelhalter mit Hartmetalleinlagen
Needle holders with tungste-carbide inserts
Portaghi con inserti al tungsteno
Portaagujas con plaquitas de carburo de tungsteno
Porte-aiguilles avec plaquettes en carbure de tungstène

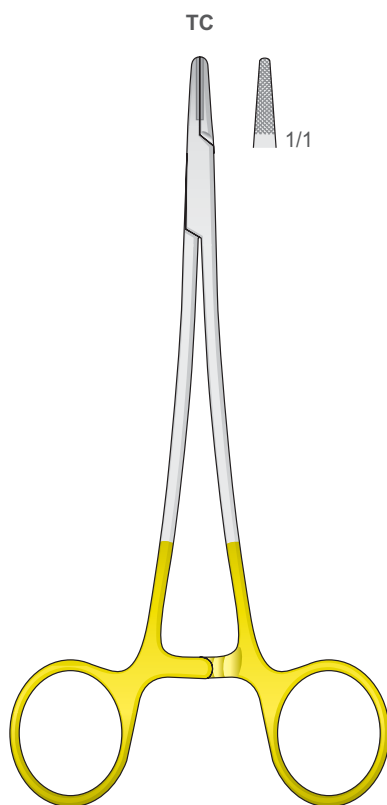

PH-79
145 mm

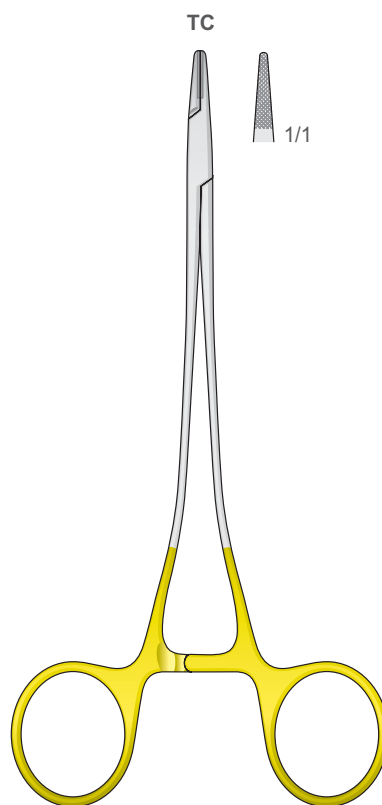

FINE SWEDISH PATTERN
PH-85
150 mm

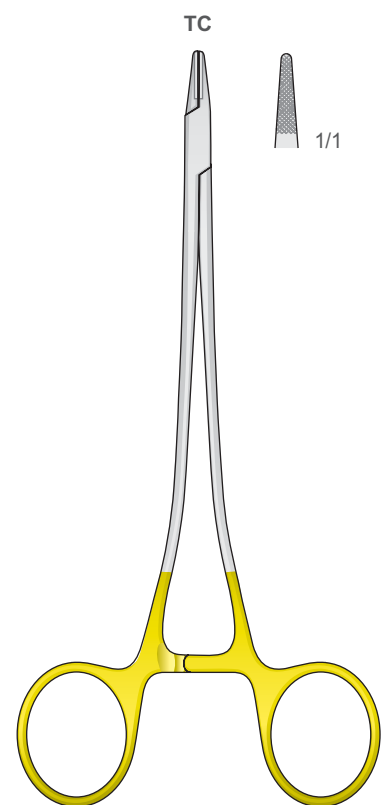

SWEDISH MOD.
PH-106
150 mm

Nadelhalter
Needle Holders
Port'aghi
Portaagujas
Porte aiguilles

Nadelhalter mit Hartmetalleinlagen - Needle Holders with tungsten-carbide inserts
Portaghi con inserti al tungsteno - Porte aiguilles avec plaquettes en carbure de tungstène
Portaagujas con plaquitas de carburo de tungsteno

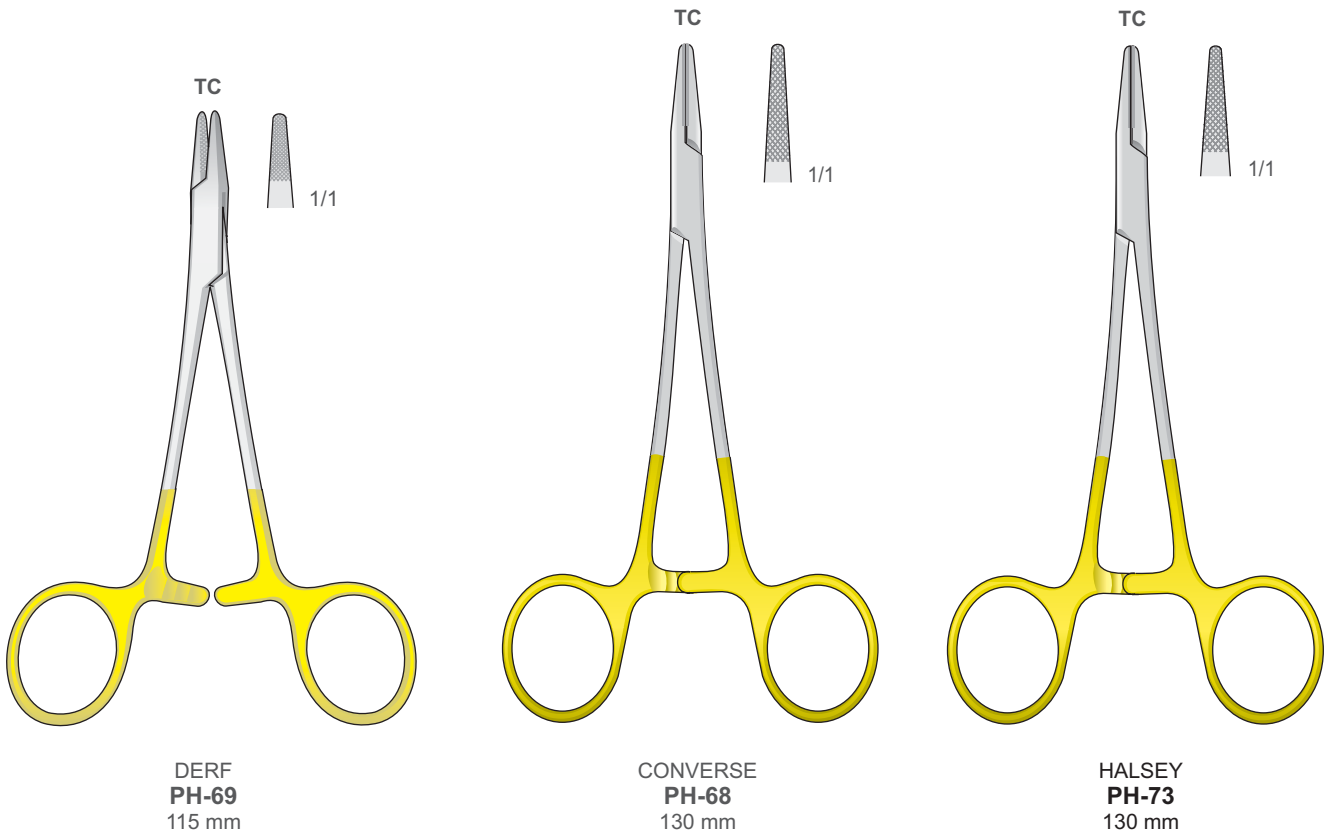
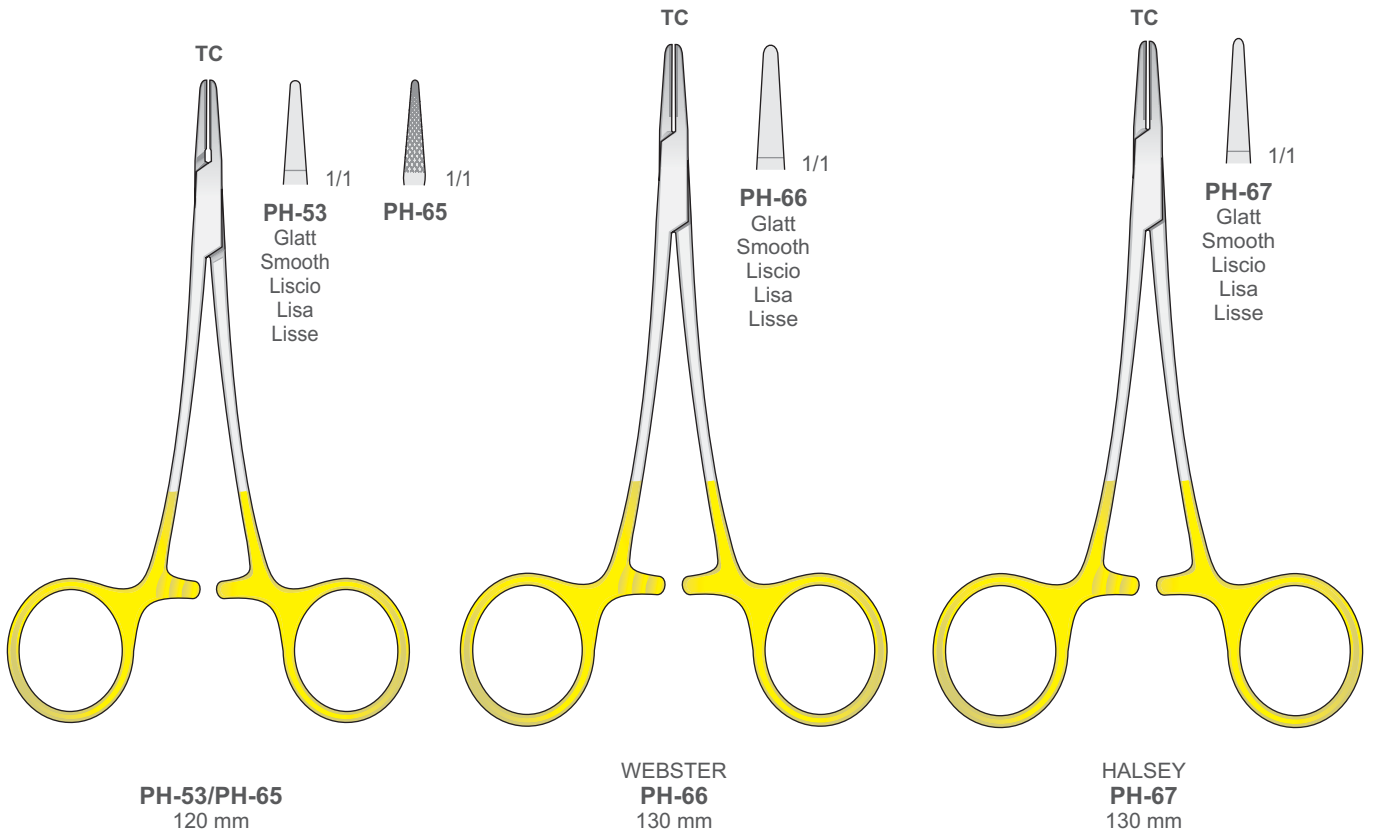

Nadelhalter mit Hartmetalleinlagen - Needle Holders with tungsten-carbide inserts
 Portaghi con inserti al tungsteno - Porte aiguilles avec plaquettes en carbure de tungstène
 Portaagujas con plaquitas de carburo de tungsteno

Nadelhalter
 Needle Holders
 Port'aghi
 Portaagujas
 Porte aiguilles

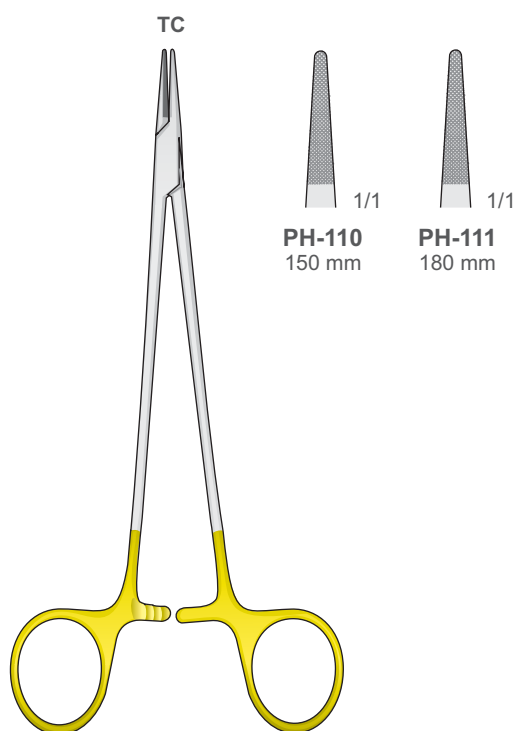

DE BAKEY
PH-110/PH-111

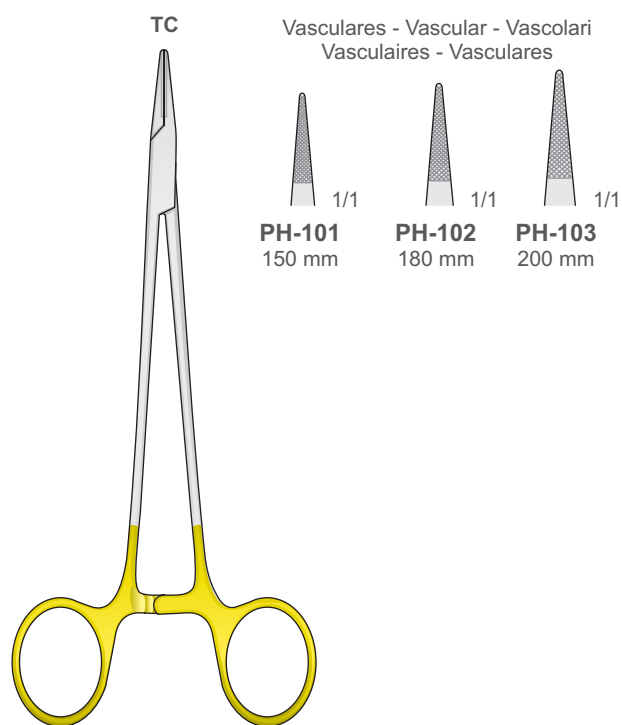

MICRO-VASCULAR
PH-101/PH-103

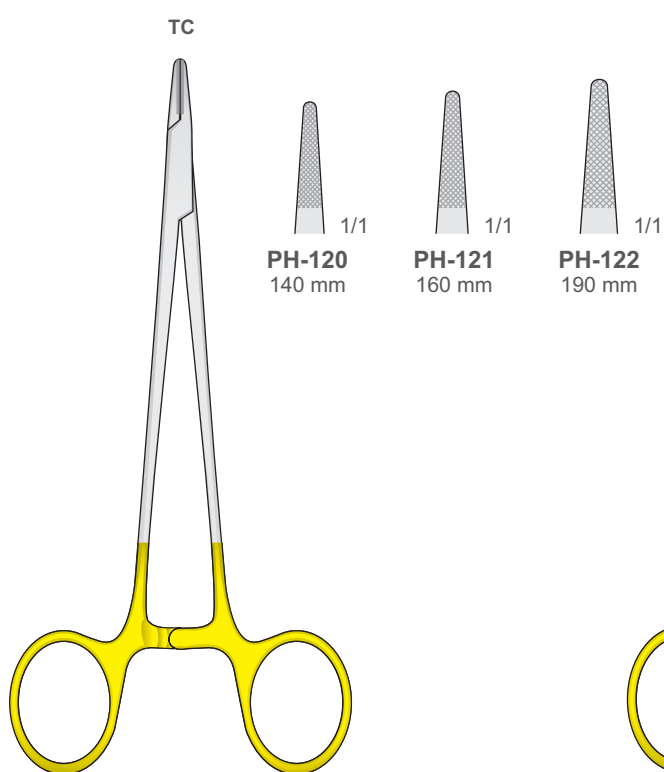

MAYO-HEGAR
PH-120/PH-122

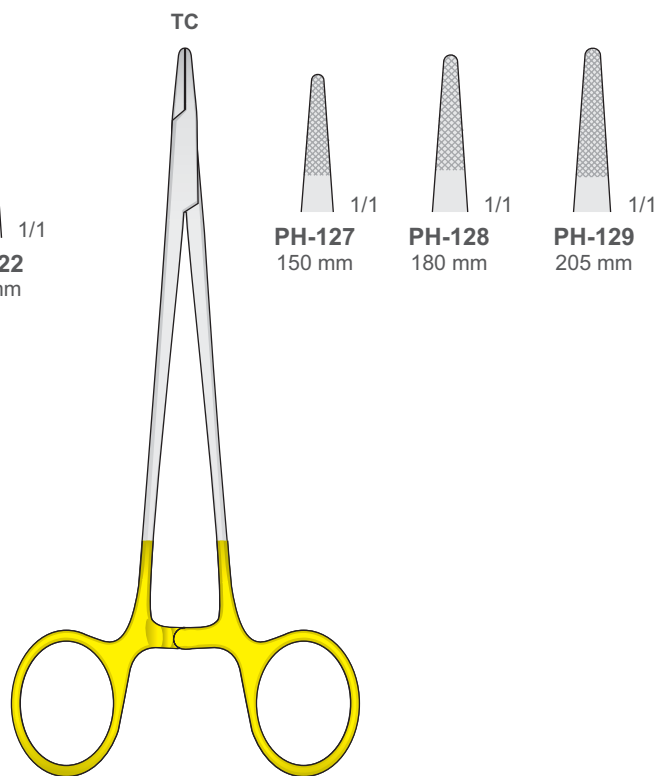

MAYO-HEGAR-FINO
PH-127/PH-129

Nadelhalter
Needle Holders
Port'aghi
Portaagujas
Porte aiguilles

Nadelhalter mit Hartmetalleinlagen - Needle Holders with tungsten-carbide inserts
Portaghi con inserti al tungsteno - Portaagujas con plaquetas de carburo de tungsteno
Porte aiguilles avec plaquettes en carbure de tungstène

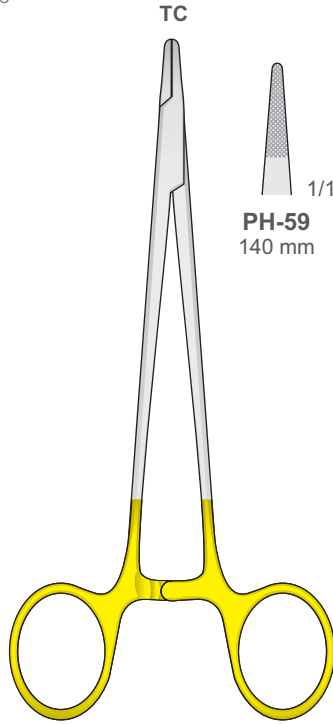

HEGAR
PH-59/PH-76

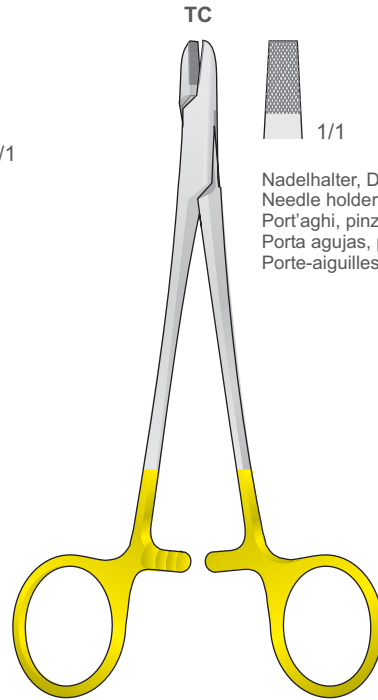
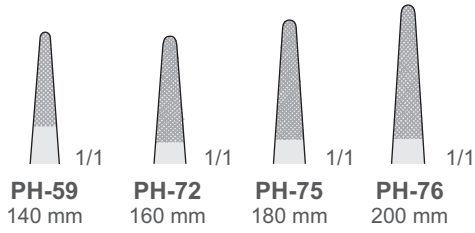

PH-58
150 mm

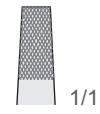

Nadelhalter, Draht-Zangen
Needle holder, wire forceps
Port'aghi, pinze per fili d'acciaio
Porta agujas, pinzas para hilos
Porte-aiguilles, pinces à saisir

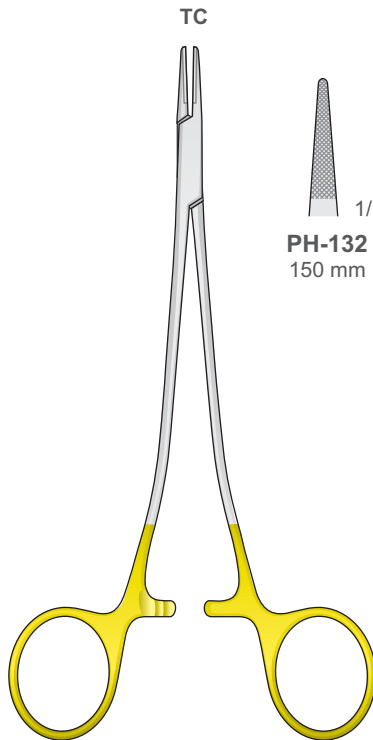

SAROT
PH-132/PH-134

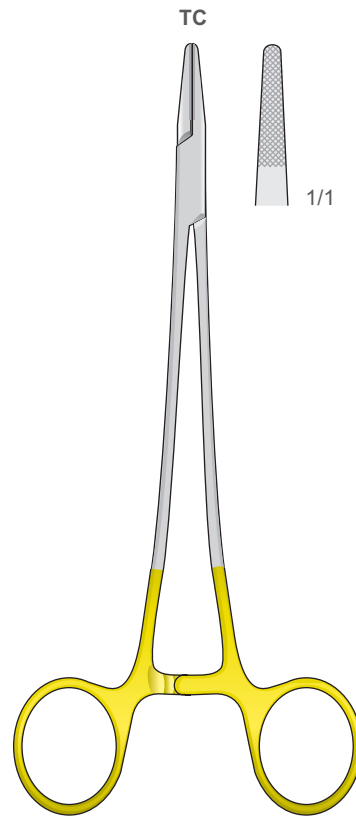
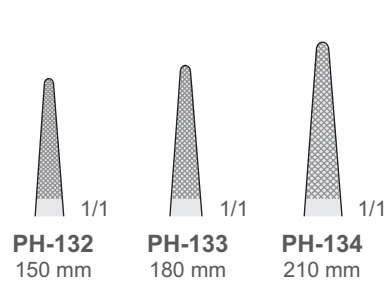

CRILE-WOOD
PH-77
180 mm

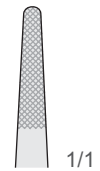



Nadelhalter mit Hartmetalleinlagen - Needle Holders with tungsten-carbide inserts
Portaghi con inserti al tungsteno - Portaagujas con plaquitas de carburo de tungsteno
Porte aiguilles avec plaquettes en carbure de tungstène

Nadelhalter
Needle Holders
Port'aghi
Portaagujas
Porte aiguilles

Ein Ring abgewinkelt
One ring angled
Un anello angolato
Un anneau décalé

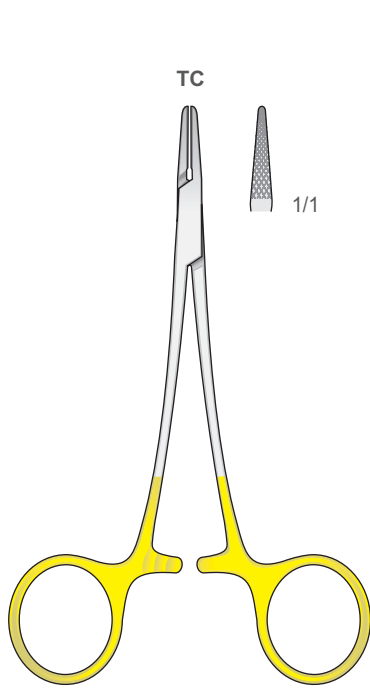

PH-99
120 mm

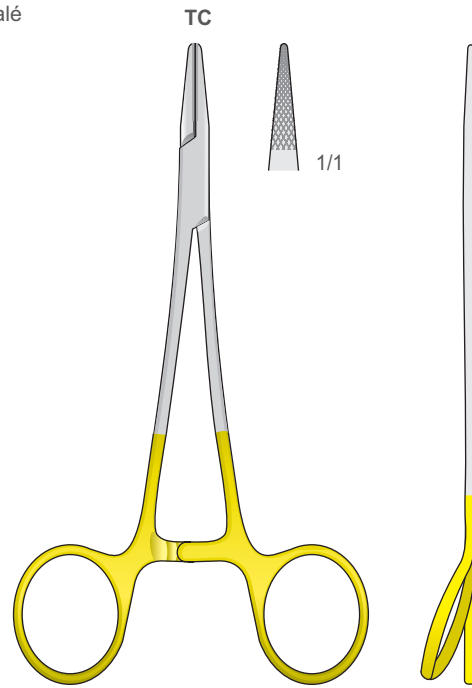

CRILE-WOOD PH-100
150 mm

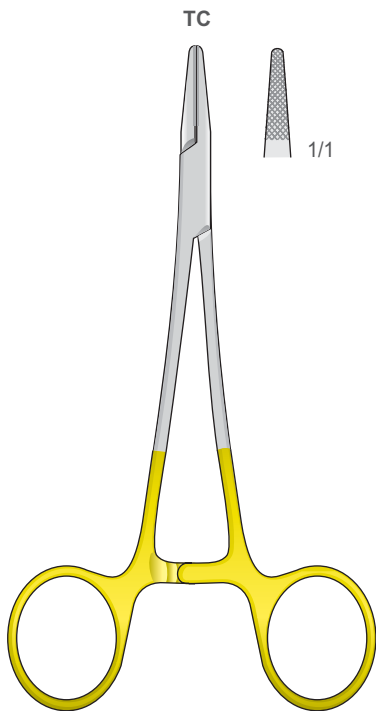

BABY-CRILE-WOOD PH-54
150 mm

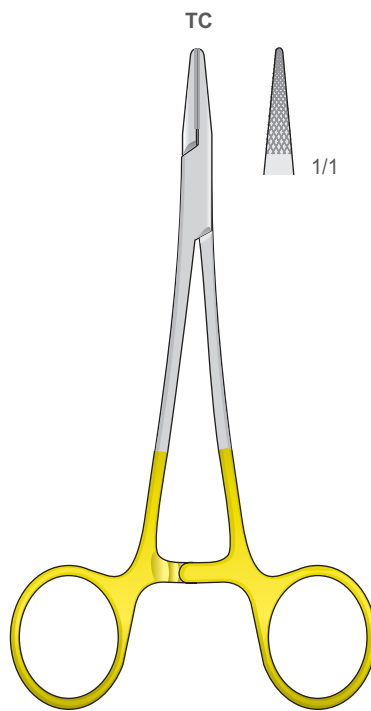

CRILE-WOOD PH-71
150 mm

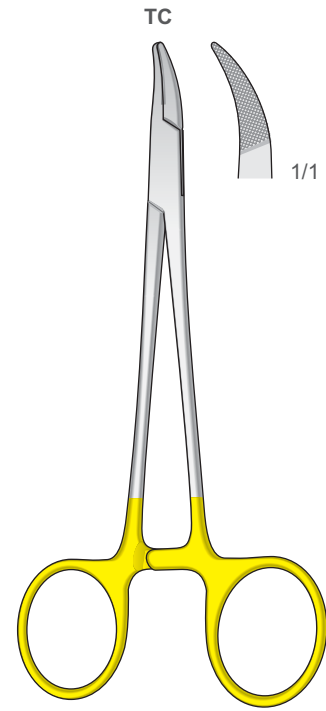

CRILE-WOOD PH-90
150 mm

Nadelhalter
Needle Holders
Port'aghi
Portaagujas
Porte aiguilles

Nadelhalter mit Schere - Needle holders with scissors
Port'aghi con forbici - Portaagujas con tijeras
Porte aiguilles avec ciseaux

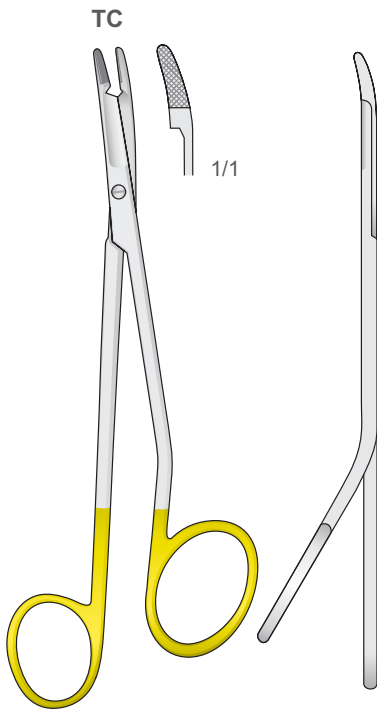

MINI-GILLIES
PO-99
145 mm

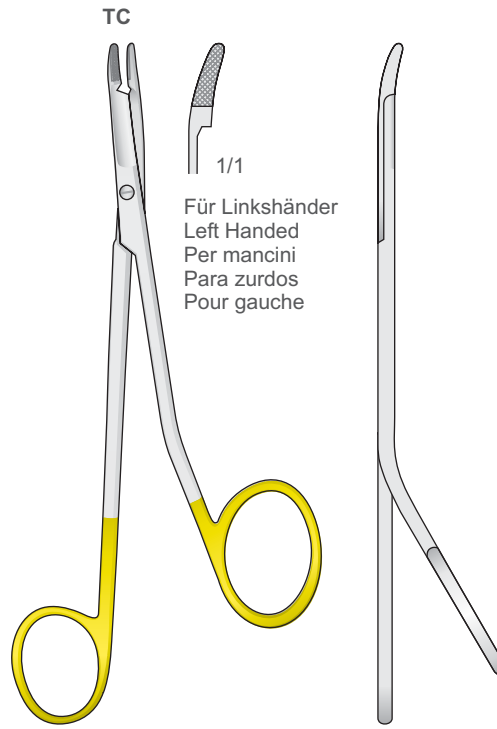

MINI-GILLIES
PO-99L
145 mm

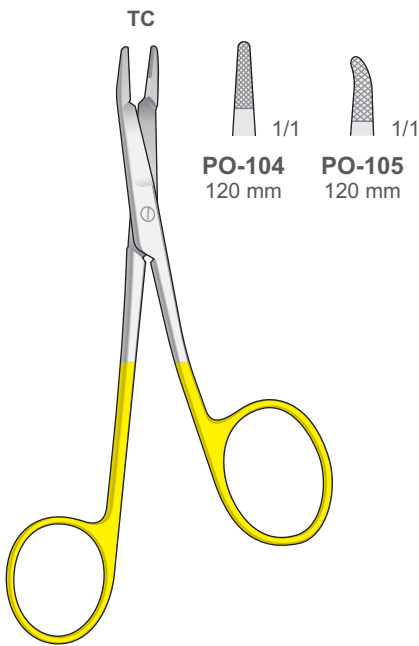

FOSTER-GILLIES
PO-104/PO-105
120 mm

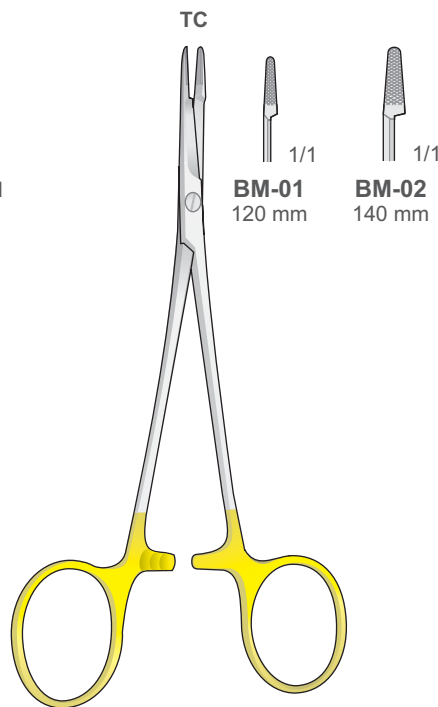

OLSEN-HEGAR
BM-01/BM-02

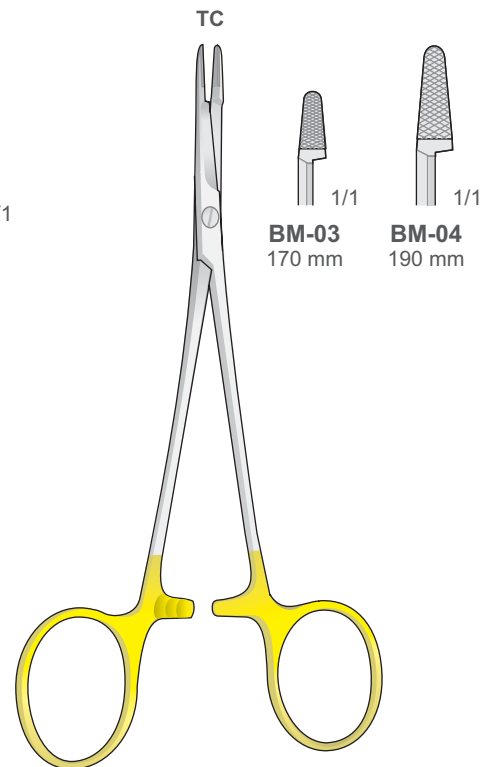

OLSEN-HEGAR
BM-03/BM-04



Nadelhalter
Needle Holders
Port'aghi
Portaagujas
Porte aiguilles

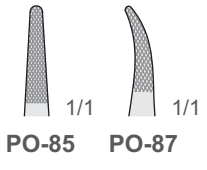
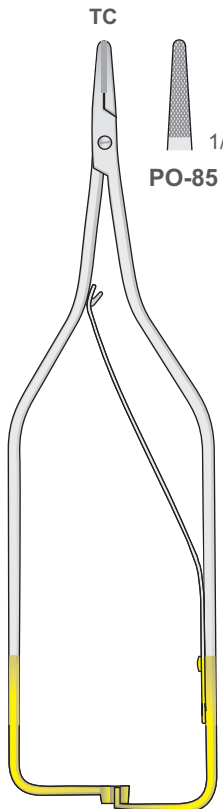

ARRUGA
PO-85/PO-87
160 mm

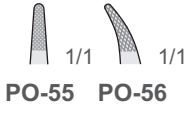
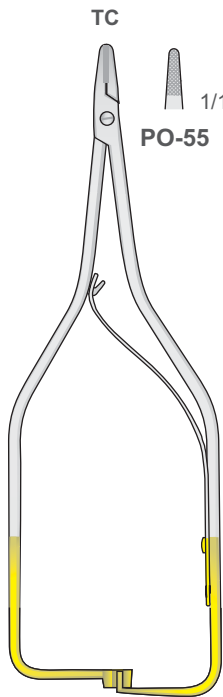

BOYNTON
PO-55/PO-56
120 mm

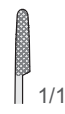
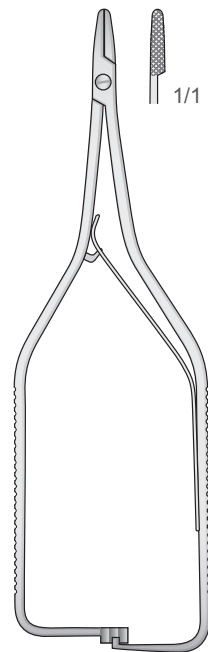

BOYNTON
PO-88
120 mm

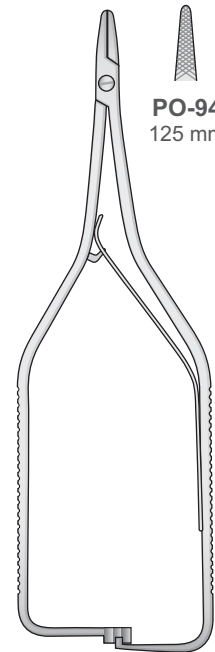

BOYNTON
PO-94
125 mm

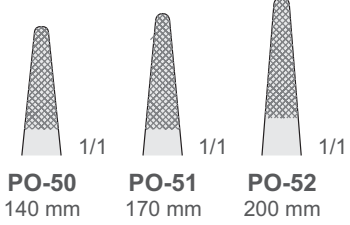
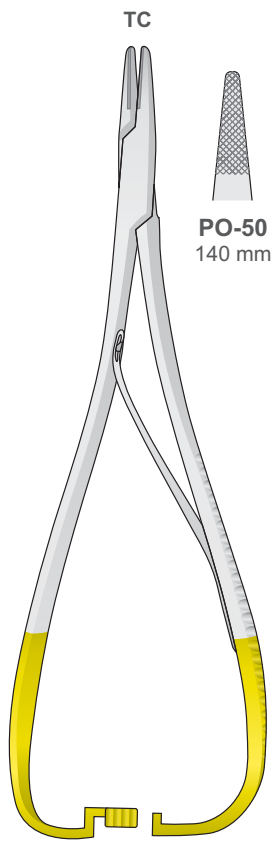

MATHIEU
PO-50/PO-52

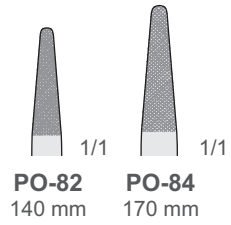
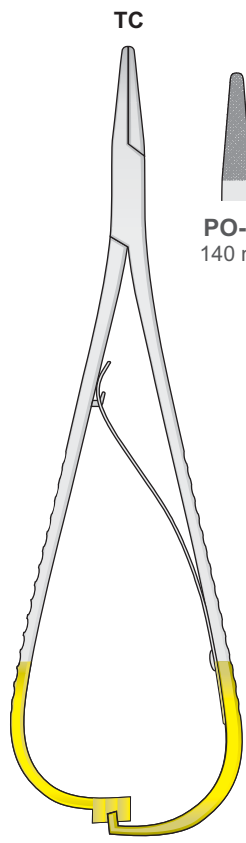

MATHIEU
PO-82/PO-84

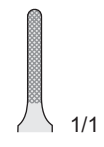
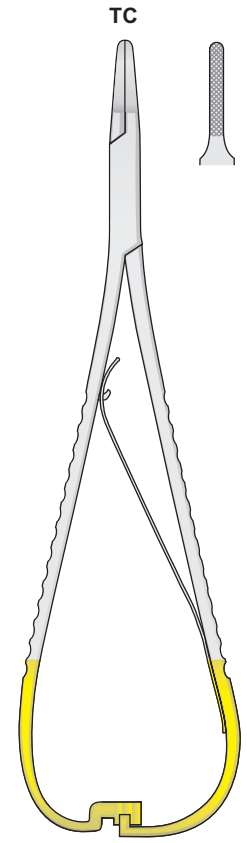

LICHTENBERG
PO-86
175 mm

Nadelhalter
Needle Holders
Port'aghi
Portaagujas
Porte aiguilles

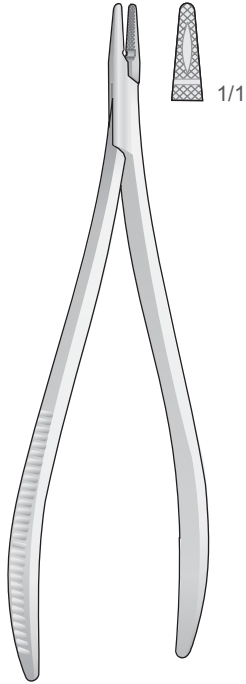

CRILE
PO-37
150 mm

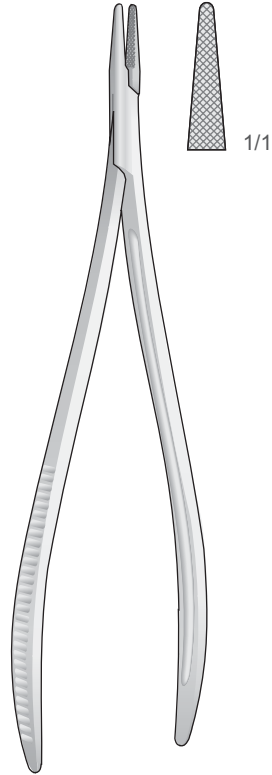

TÖNNIS
PO-38
190 mm

Schlankesmodell - Delicate pattern - Modello fine
Modelo delegado - Modèle fin

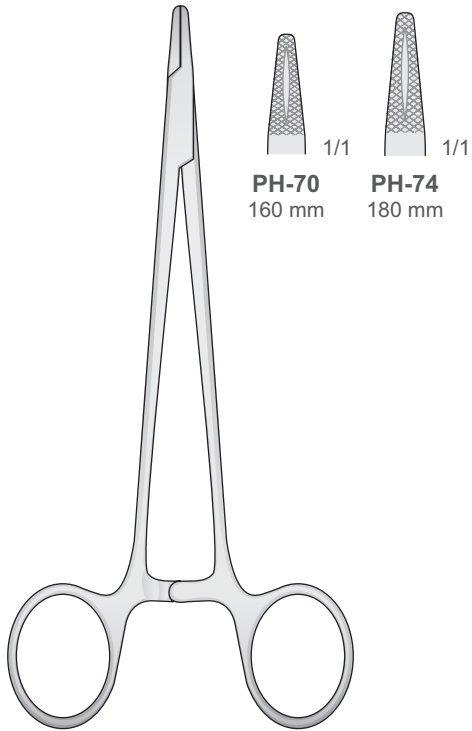

HEGAR
PH-70/PH-74

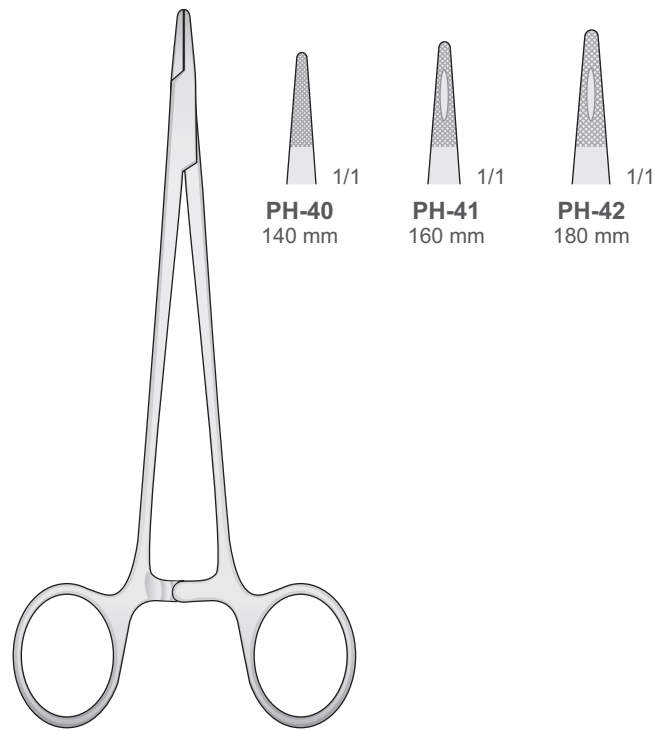

MAYO-HEGAR
PH-40/PH-42



Nadelhalter
Needle Holders
Port'aghi
Portaagujas
Porte aiguilles

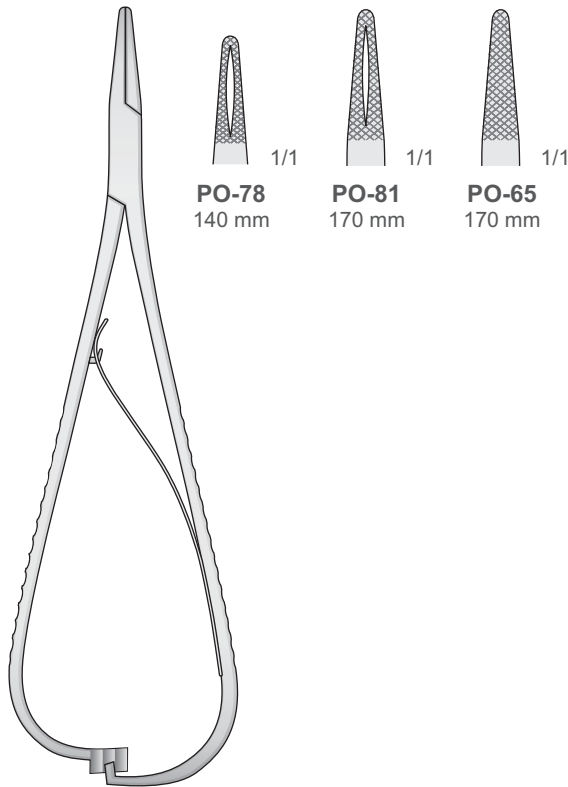

PO-78
140 mm

PO-81
170 mm

PO-65
170 mm

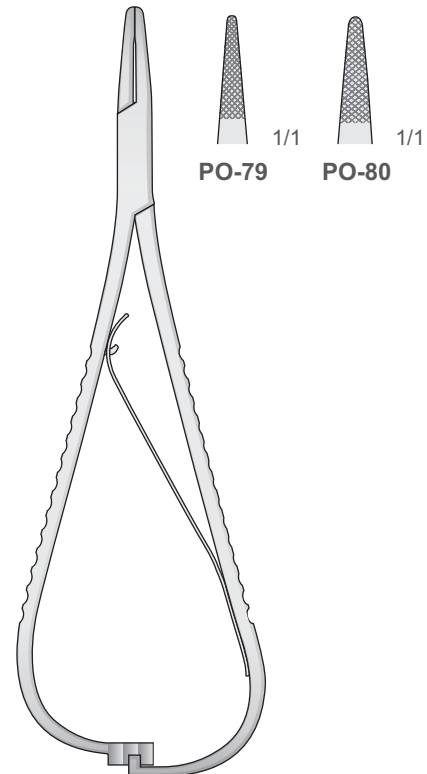

PO-79

PO-80

MATHIEU
PO-65/PO-81

MATHIEU
PO-79/PO-80
140 mm

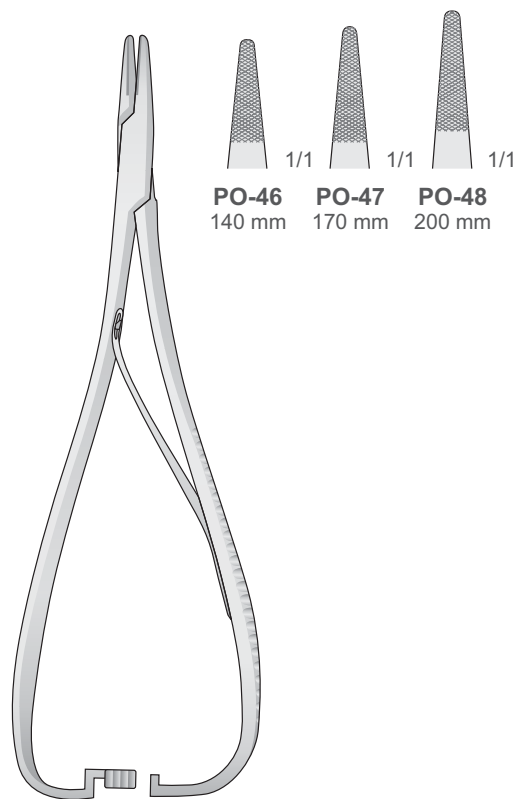

PO-46
140 mm

PO-47
170 mm

PO-48
200 mm

MATHIEU
PO-46/PO-48

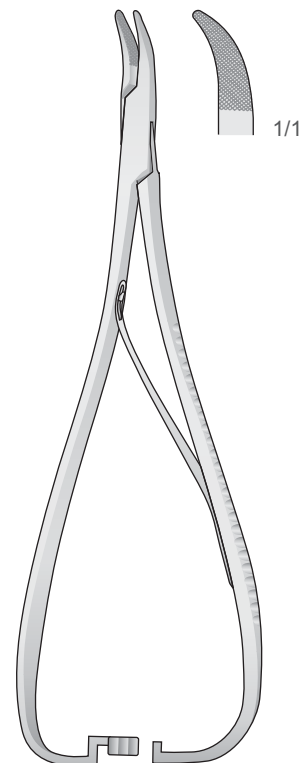

1/1

PO-40
140 mm

Nadelhalter
Needle Holders
Port'aghi
Portaagujas
Porte aiguilles

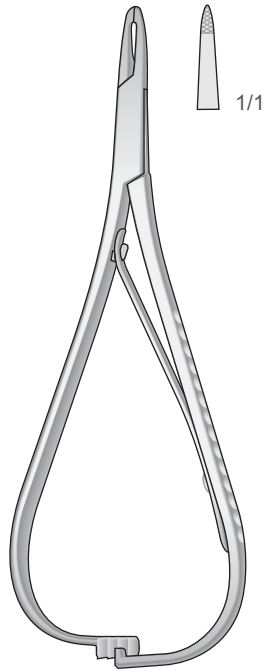

MATHIEU
PO-45
125 mm

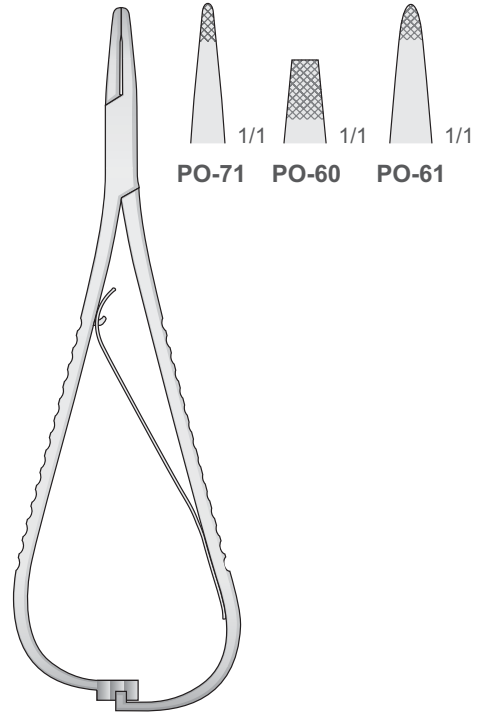

MATHIEU
PO-60/PO-71
140 mm

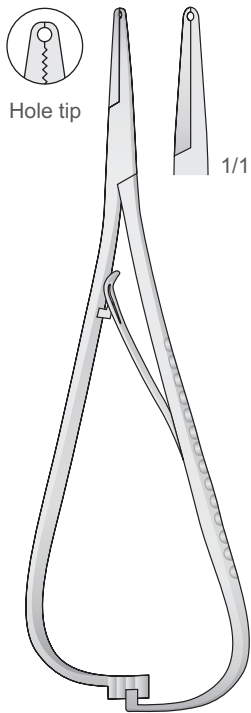

SMAHA
PO-68
140 mm

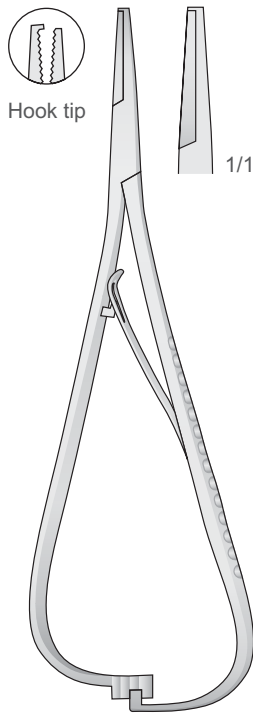

SMAHA
PO-69
140 mm

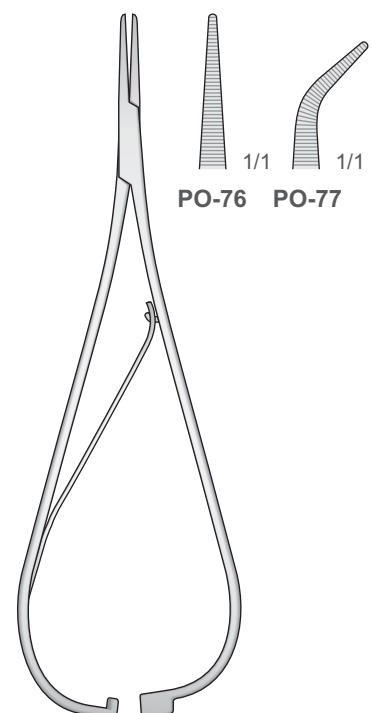

SMAHA
PO-76/PO-77
140 mm

.7

Arterienklemmen, Tuchklemmen
Hemostatic Forceps, Towel Clamps
Pinze emostatiche, Fissateli
Pinzas hemostáticas, Pinzas de campo
Pincés hémostatiques, Pincés pour fixer les compresses

Zahnärztliche Chirurgie
Dental surgery
Chirurgia dentale
Cirugia dental
Chirurgie dentaire





Tuchklemmen
Towel Clamps
Fissateli
Pinzas de campo
Pinces à champs

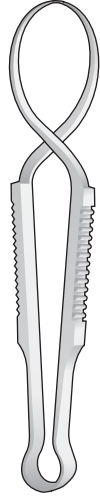

SCHAEDEL
BF-38
85 mm

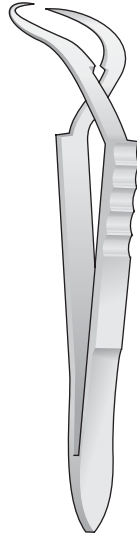

JONES
BF-48
90 mm

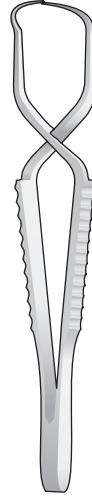

FAURE
BF-40
85 mm

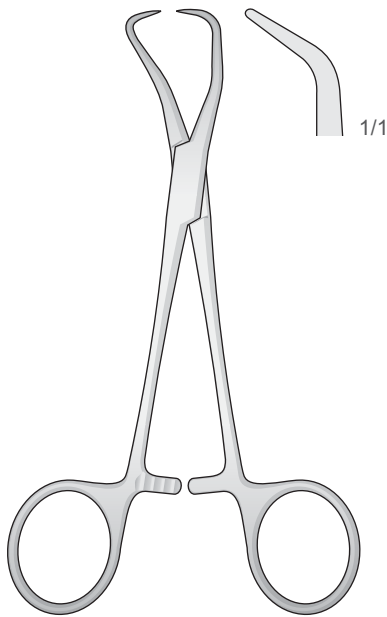

BACKHAUS
BF-42/BF-46

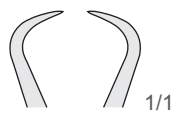

BF-42
90 mm

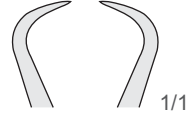

BF-41
100 mm

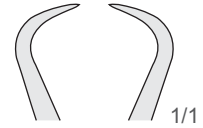

BF-44
110 mm

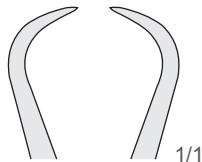

BF-46
130 mm

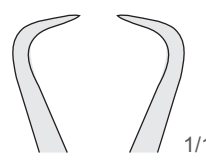

BF-43
135 mm

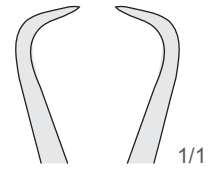

BF-45
140 mm



Tuchklemmen
Towel Clamps
Fissateli
Pinzas de campo
Pinces à champs

Für Papiertücher
For paper cloths
Per teli di carta
Para paños
Pour Champs en papier

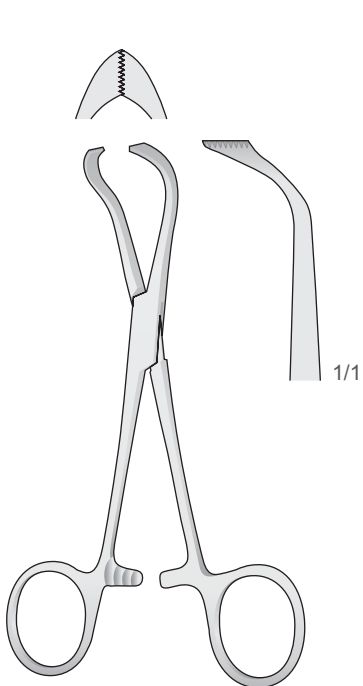

LORNA
BF-50
100 mm

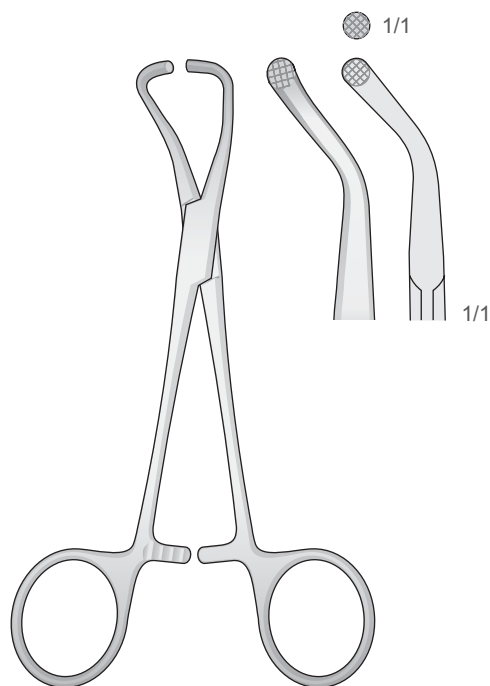

BF-52
130 mm

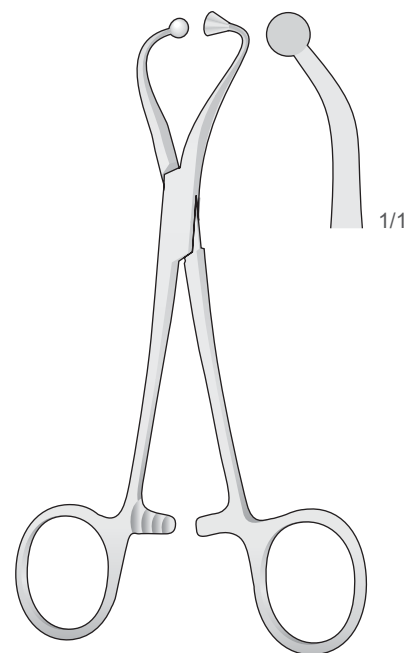

BF-75
140 mm



Kornzangen
Dressing Forceps
Pinze porta tamponi
Pinzas porta tampones
Pincas porte-tampons

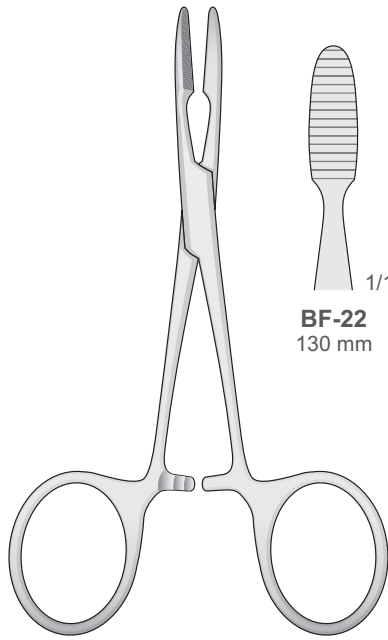

BF-22
130 mm

BF-24
140 mm

PEAN-MURPHY
BF-22/BF-24

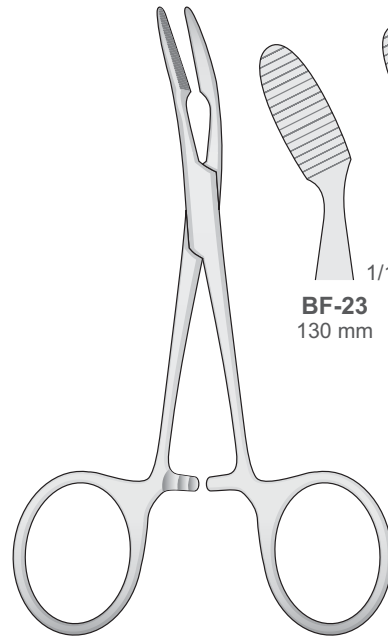

BF-23
130 mm

BF-25
140 mm

PEAN-MURPHY
BF-23/BF-25

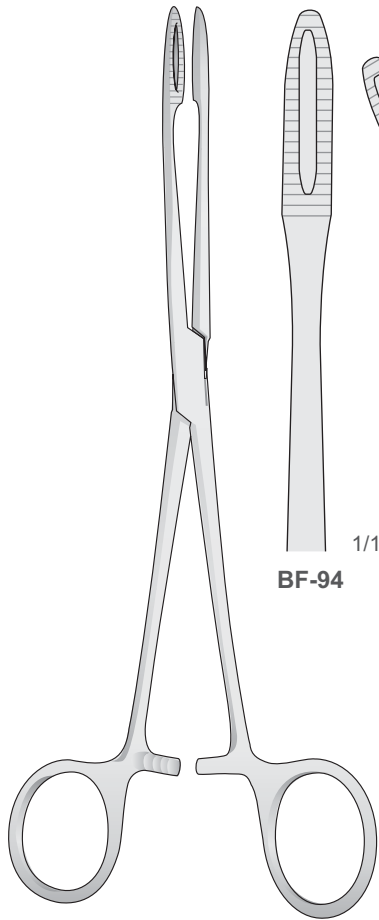

BF-94

BF-95

GROSS
BF-94/BF-95
200 mm

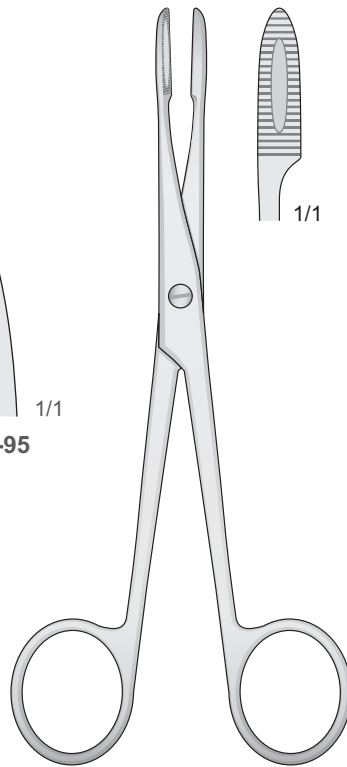

1/1

GROSS
BF-10 130 mm
BF-12 160 mm

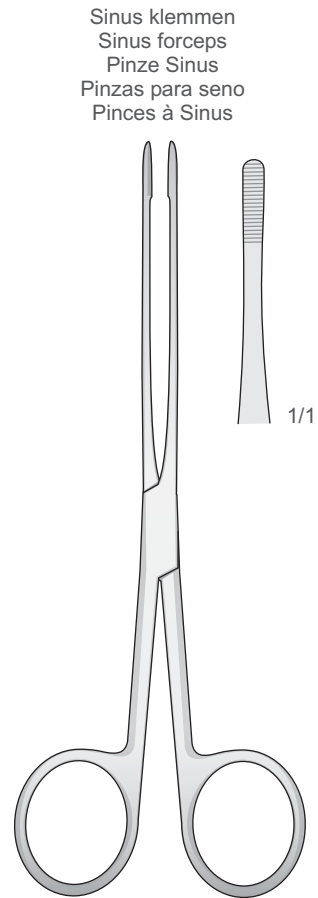

Sinus klemmen
Sinus forceps
Pinze Sinus
Pinzas para seno
Pincas à Sinus

1/1

LISTER
BF-20
150 mm



Arterienklemmen
Hemostatic Forceps
Pinze emostatiche
Pinzas hemostáticas
Pincas hémostatiques

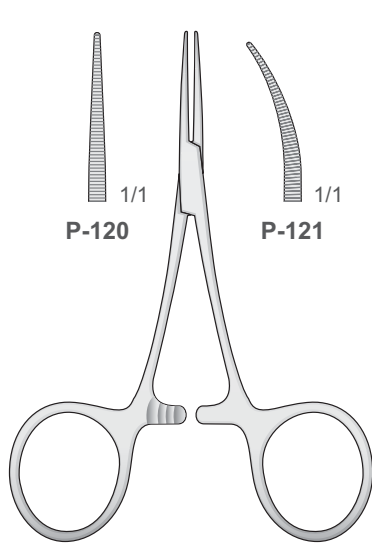

HARTMANN/BABY-MOSQUITO
P-120/P-121
95 mm

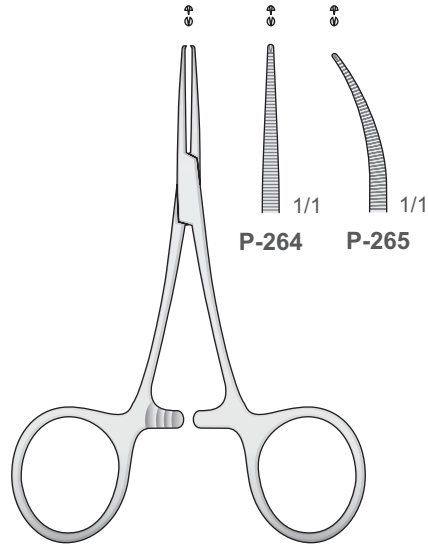

HARTMANN/BABY-MOSQUITO
P-264/P-265
95 mm

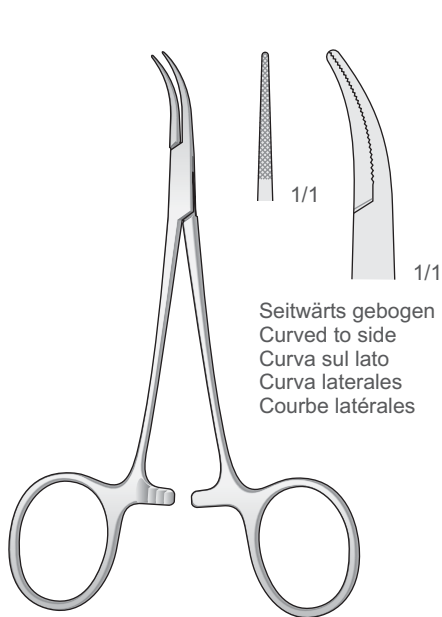

DANDY-MOSQUITO
P-332
120 mm

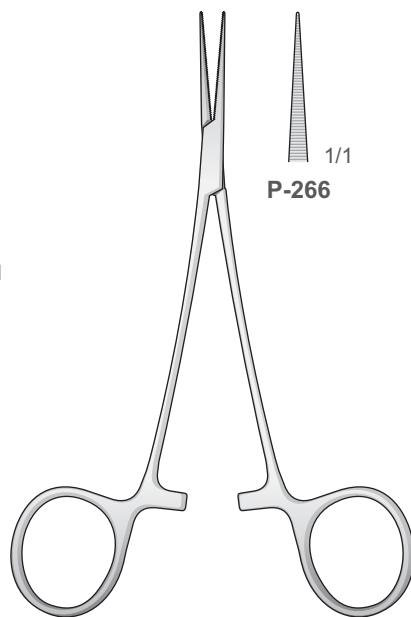

JACOBSON-MICRO
P-266
130 mm

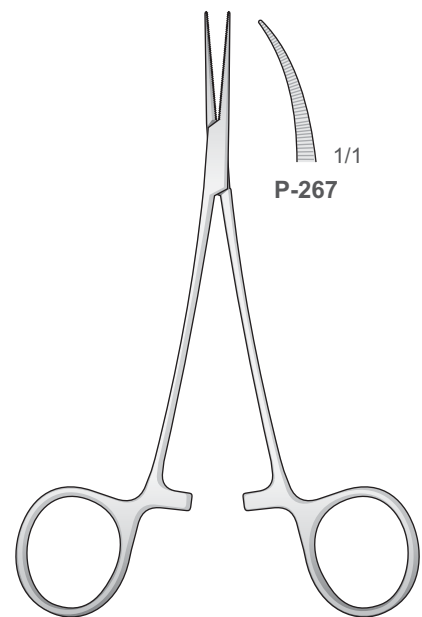

JACOBSON-MICRO
P-267
130 mm

Seitwärts gebogen
Curved to side
Curva sul lato
Curva laterales
Courbe latérales



Arterienklemmen
Hemostatic Forceps
Pinze emostatiche
Pinzas hemostáticas
Pincas hémostatiques

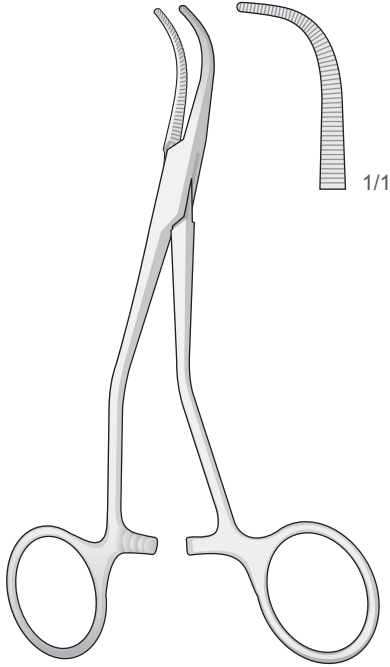

P-15
130 mm

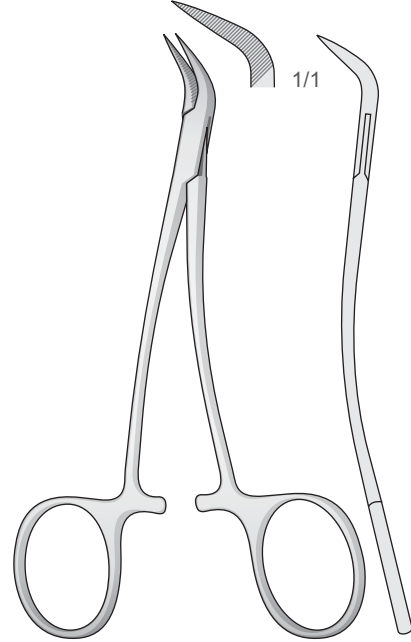

**PEET
DR-40**
120 mm

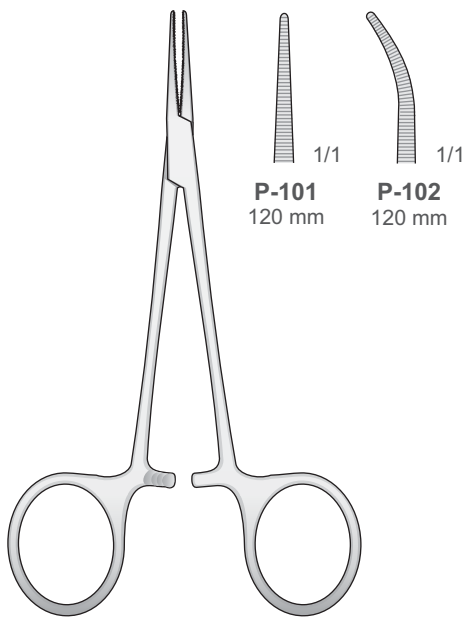

**MICRO-HALSTED
P-101/P-102**

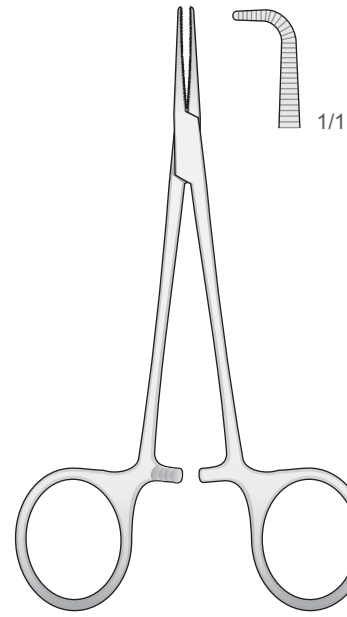

**MICRO-HALSTED
P-135**
115 mm



Arterienklemmen
Hemostatic Forceps
Pinze emostatiche
Pinzas hemostáticas
Pinces hémostatiques

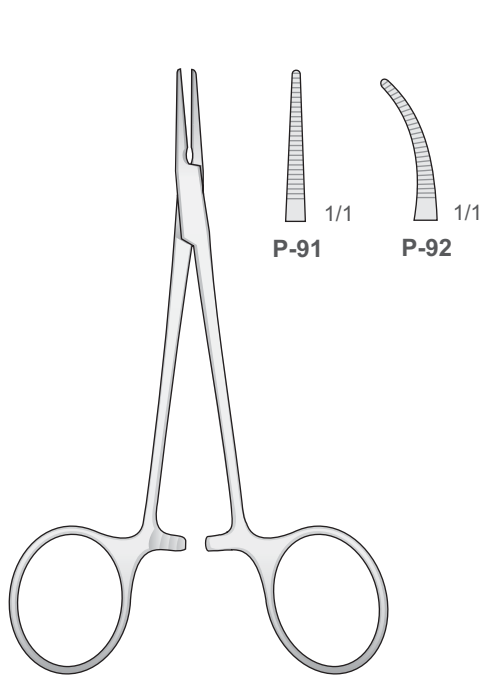

HALSTED
P-91/P-92
125 mm

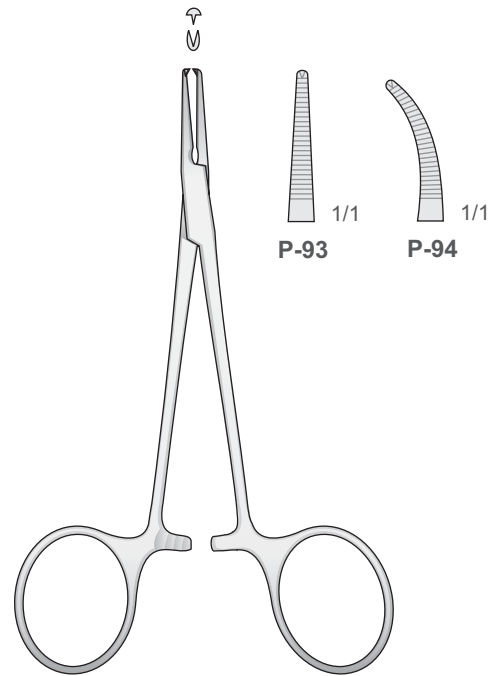

HALSTED
P-93/P-94
125 mm

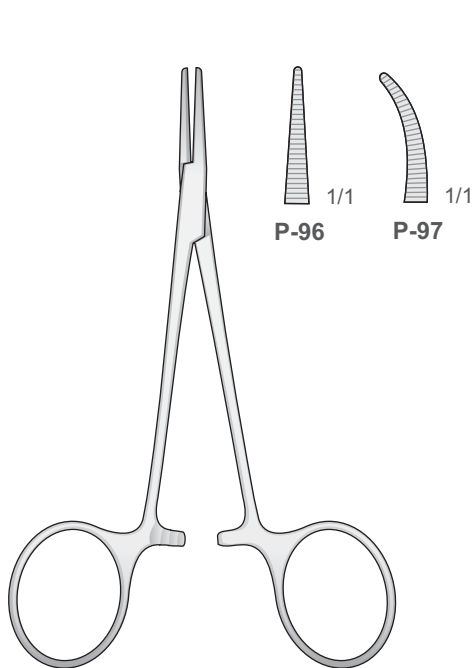

HALSTED-MOSQUITO
P-96/P-97
120 mm

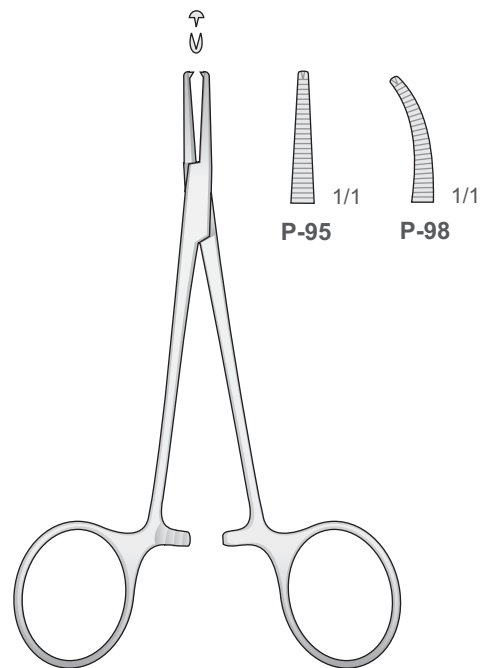

HALSTED-MOSQUITO
P-95/P-98
120 mm



Arterienklemmen
Hemostatic Forceps
Pinze emostatiche
Pinzas hemostáticas
Pincas hémostatiques

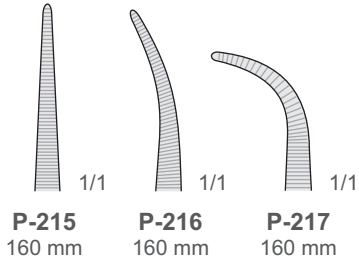
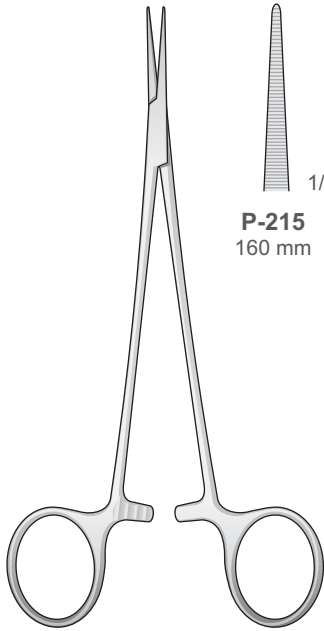

P-215/P-217
160 mm

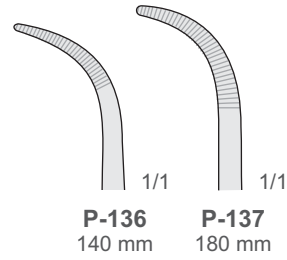
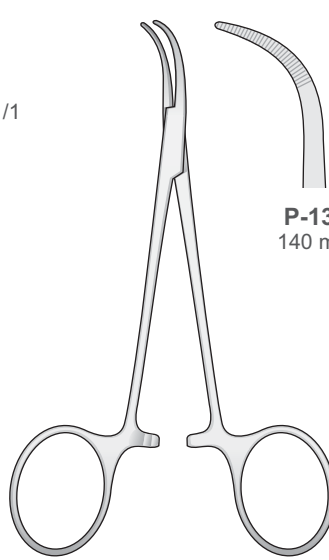

BABY-MIXTER
P-136/P-137

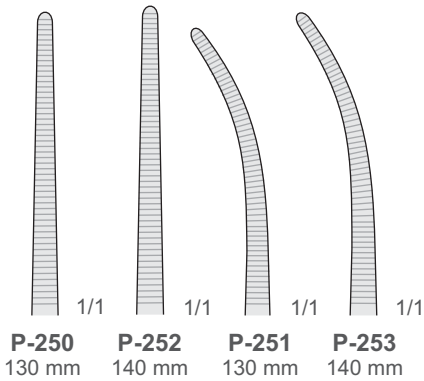
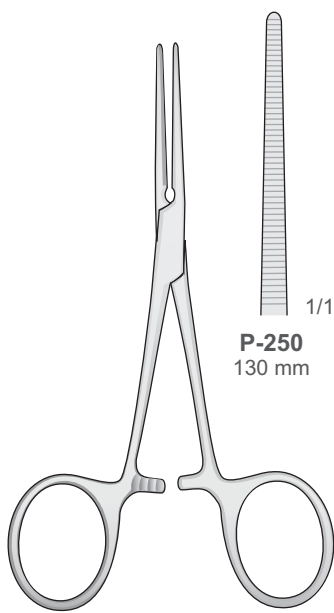

PEAN
P-250/P-253

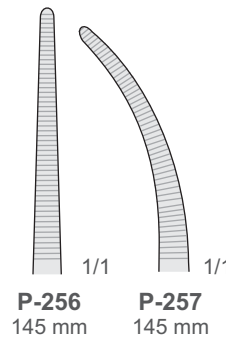
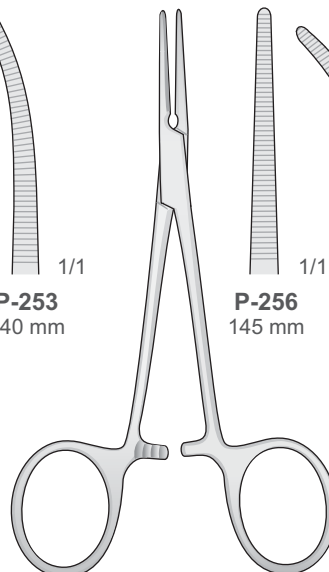

PEAN
P-256/P-257

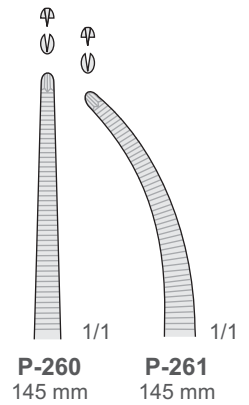
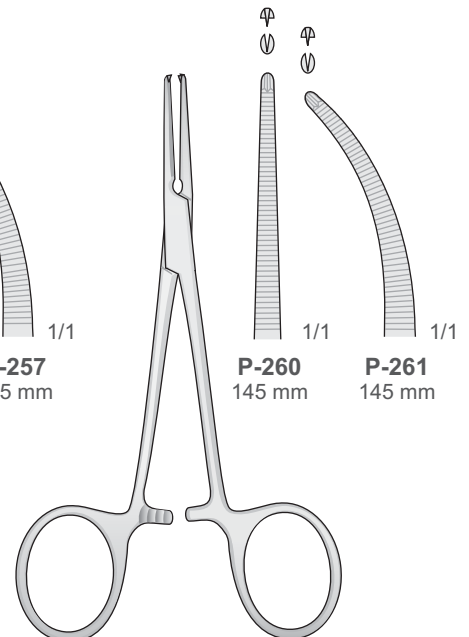

KOCHER
P-260/P-261



Arterienklemmen
Hemostatic Forceps
Pinze emostatiche
Pinzas hemostáticas
Pincas hémostatiques

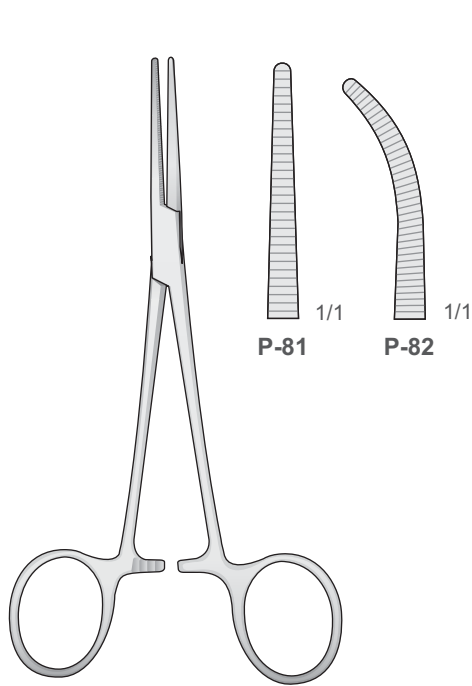

CRILE
P-81/P-82
140 mm

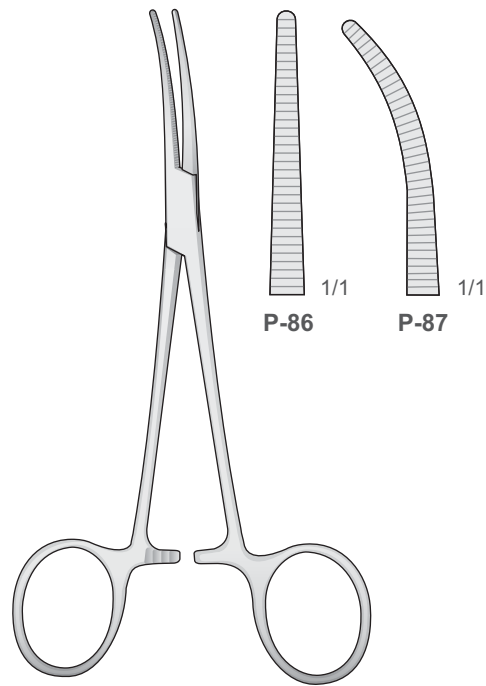

CRILE
P-86/P-87
160 mm

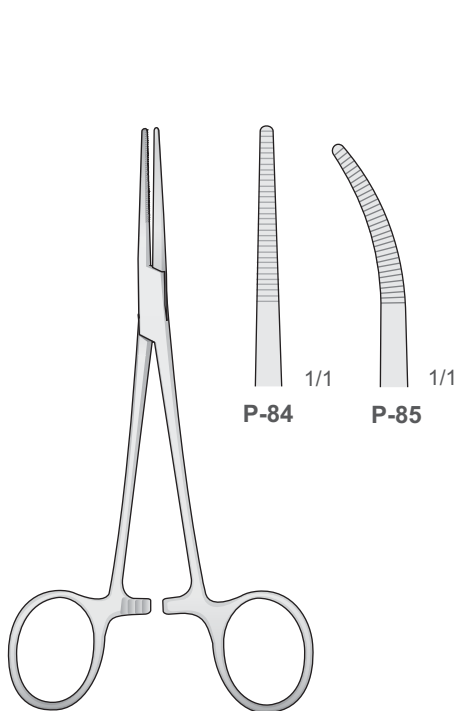

KELLY
P-84/P-85
140 mm

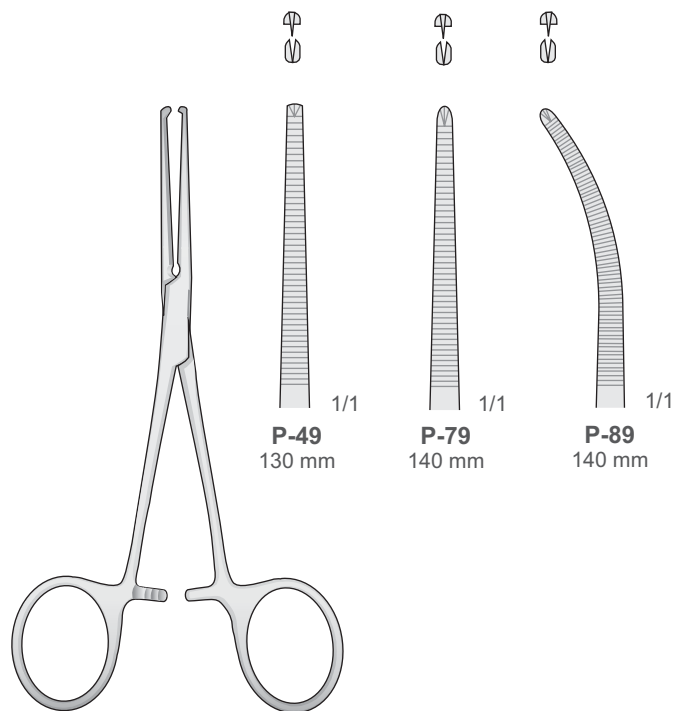

KOCHER
P-49/P-89



Arterienklemmen
Hemostatic Forceps
Pinze emostatiche
Pinzas hemostáticas
Pincas hémostatiques

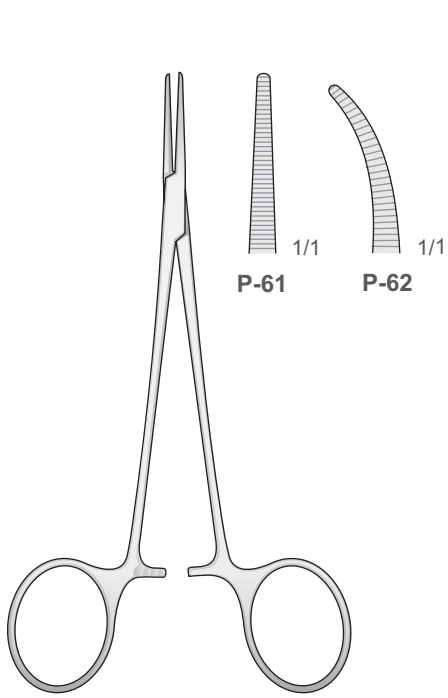

LERICHE
P-61/P-62
150 mm

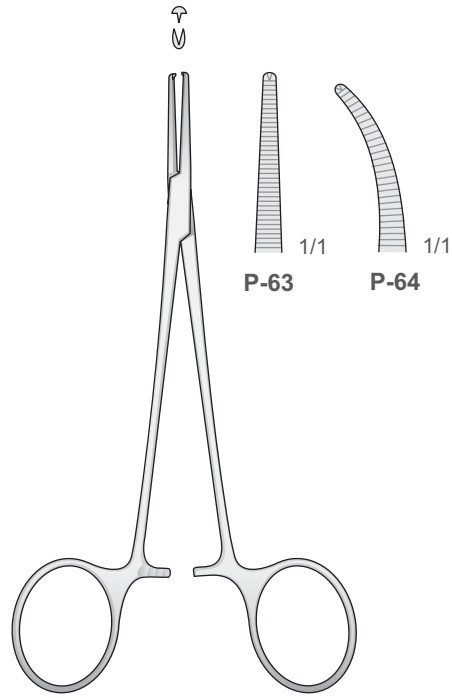

LERICHE
P-63/P-64
150 mm

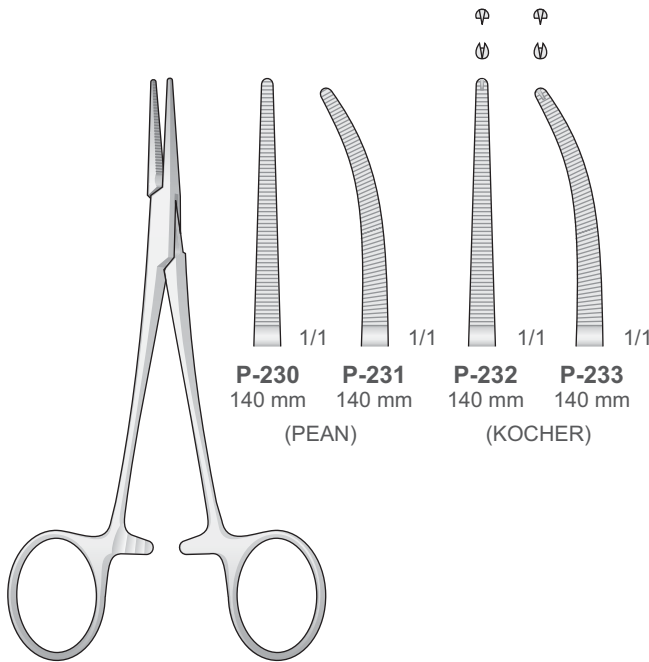

BABY-CRILE
P-230/P-233
140 mm

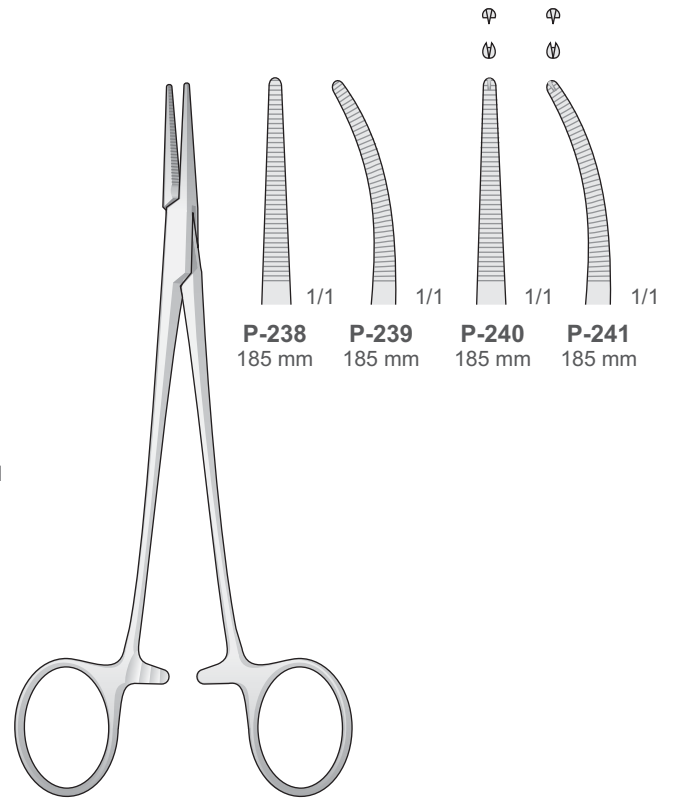

HALSTED
P-238/P-241
185 mm



Gewebefasszangen
Tissue Grasping Forceps
Pinze per tessuti
Pinzas para tejidos
Pincas pour tissus

ATRAUMA

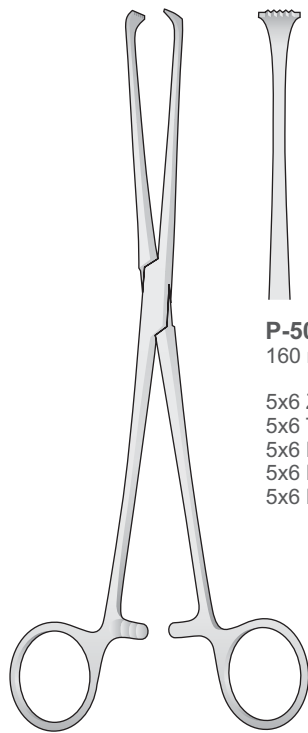

**ALLIS
P-50/P-52**



1/1

P-50
160 mm

5x6 Zähne
5x6 Teeth
5x6 Denti
5x6 Dientes
5x6 Dents

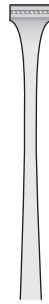

1/1

P-52
160 mm



1/1

P-115
200 mm

5x6 Zähne
5x6 Teeth
5x6 Denti
5x6 Dientes
5x6 Dents

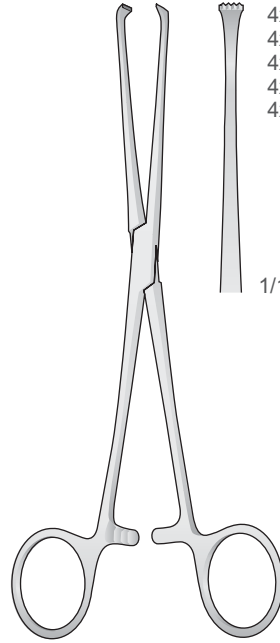

**BABY-ALLIS
P-100**
130 mm

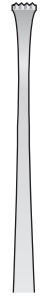

1/1

4x5 Zähne
4x5 Teeth
4x5 Denti
4x5 Dientes
4x5 Dents

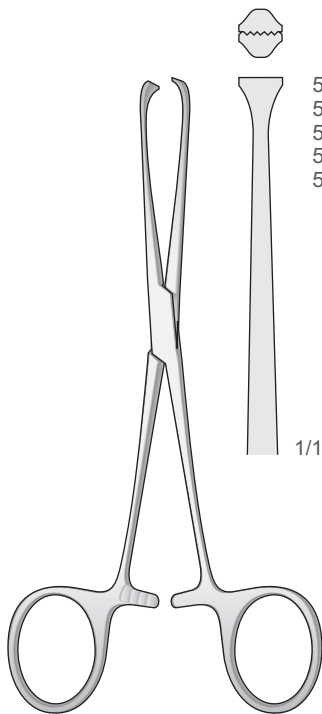

**BOYS-ALLIS
P-129**
150 mm



1/1

5x6 Zähne
5x6 Teeth
5x6 Denti
5x6 Dientes
5x6 Dents

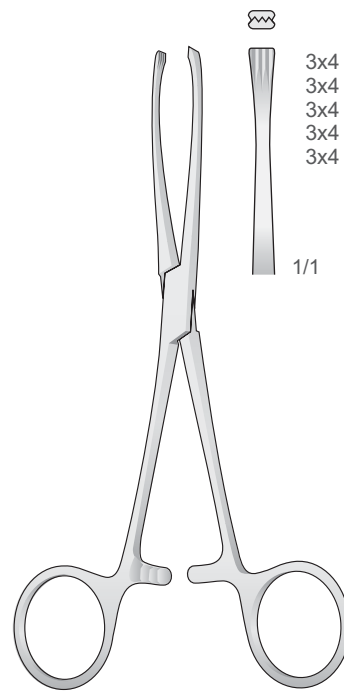

**JUDD-ALLIS
P-324**
155 mm



1/1

3x4 Zähne
3x4 Teeth
3x4 Denti
3x4 Dientes
3x4 Dents

.8

Wundhaken, Mundsperrer
Retractors, Mouth gags
Divaricatori, Apribocca
Separadores, Abrebocas
Ecarteurs, Ecarteurs buccal

Zahnärztliche Chirurgie
Dental surgery
Chirurgia dentale
Cirugia dental
Chirurgie dentaire





Wundhaken
Retractors
Divaricatori
Separadores
Ecarteurs

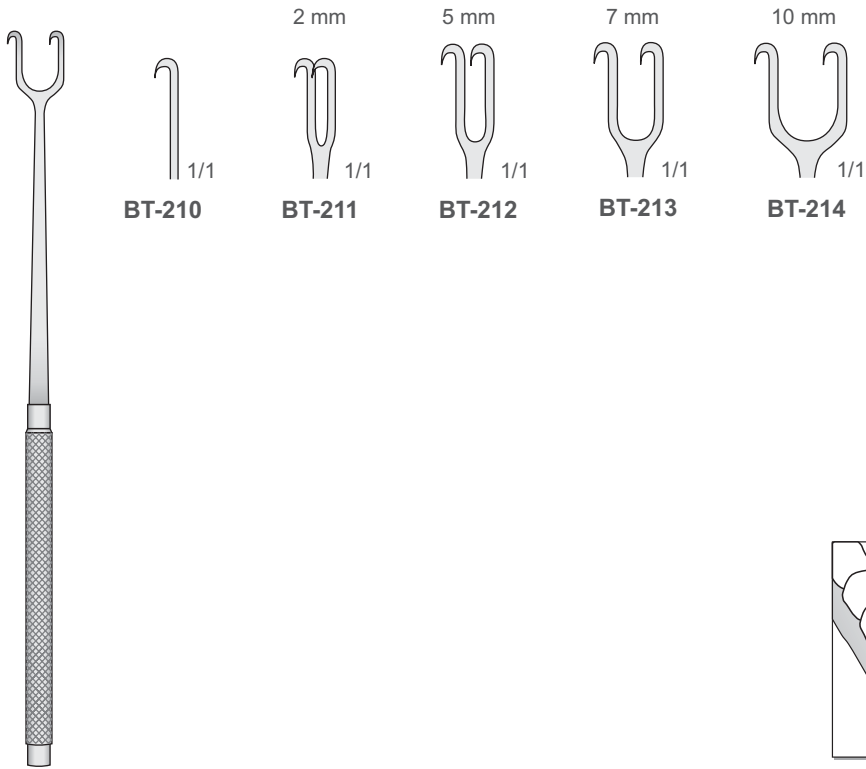

JOSEPH
BT-210/BT-214
160 mm

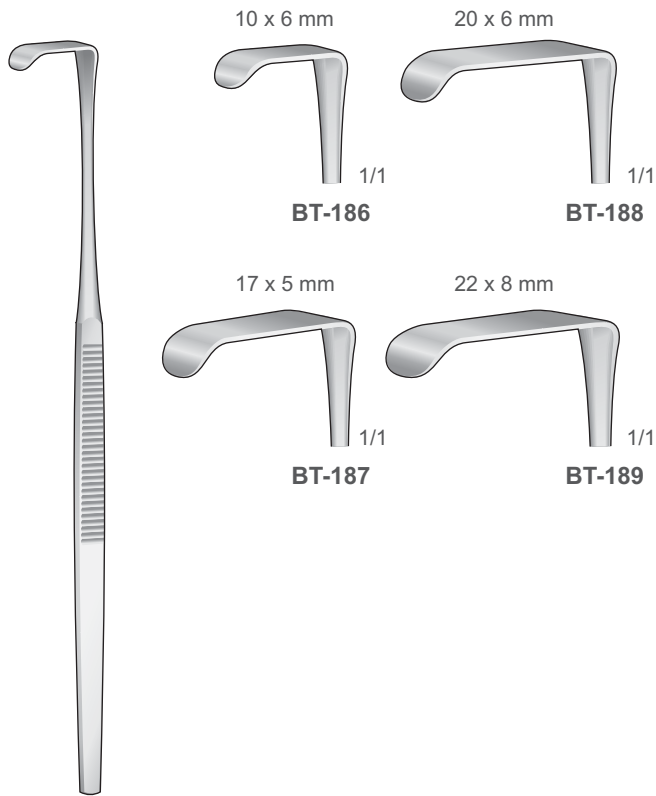
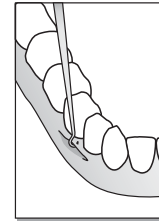

MINI-LANGENBECK
BT-186/BT-189
160 mm

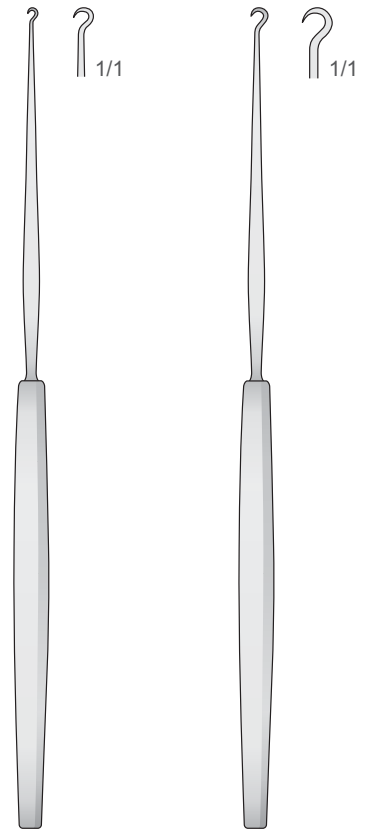

GILLIES
BT-15
180 mm

GILLIES
BT-16
180 mm



Wundhaken
Retractors
Divaricatori
Separadores
Ecarteurs

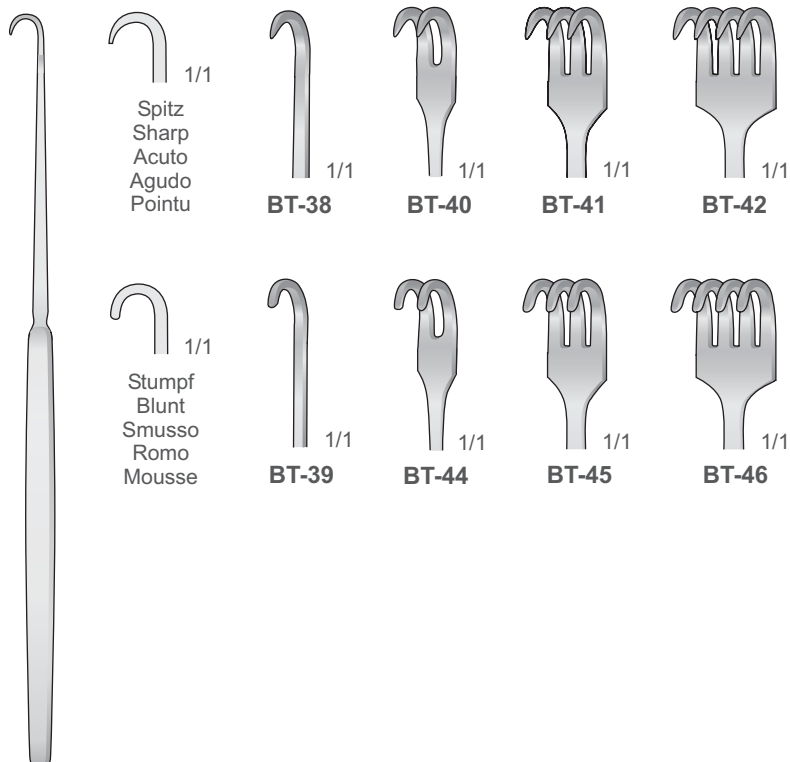

BT-38/BT-46
160 mm

Feine wundhaken flexibel-spitz
Delicate retractors flexible-sharp
Divaricatori delicati flessibili-acuti
Separadores finos flexibles-agudas
Ecarteurs fins pointu flexible

Feine wundhaken flexibel-stumpf
Delicate retractors flexible-blunt
Divaricatori delicati flessibili-smussi
Separadores finos flexibles-romas
Ecarteurs fins mousse flexible

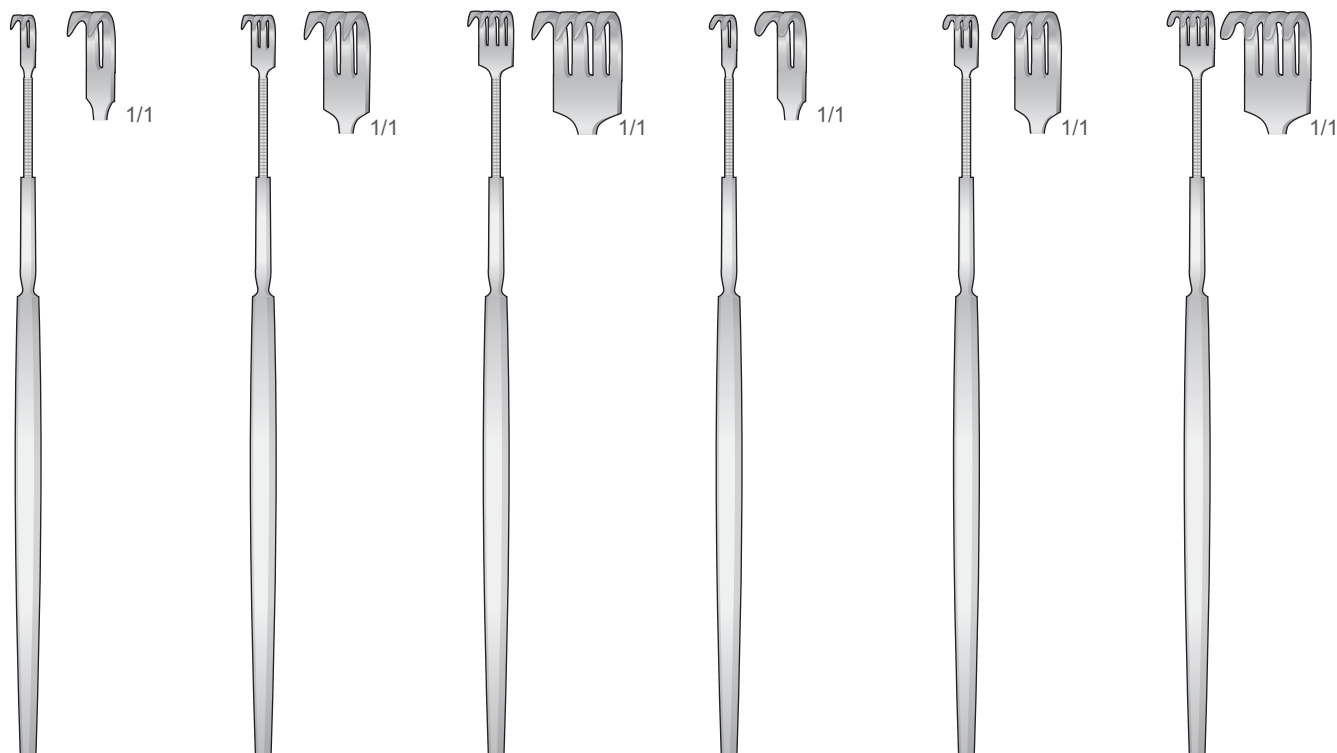

BT-50
150 mm

BT-51
150 mm

BT-52
150 mm

BT-54
150 mm

BT-55
150 mm

BT-56
150 mm



Wundhaken
Retractors
Divaricatori
Separadores
Ecarteurs

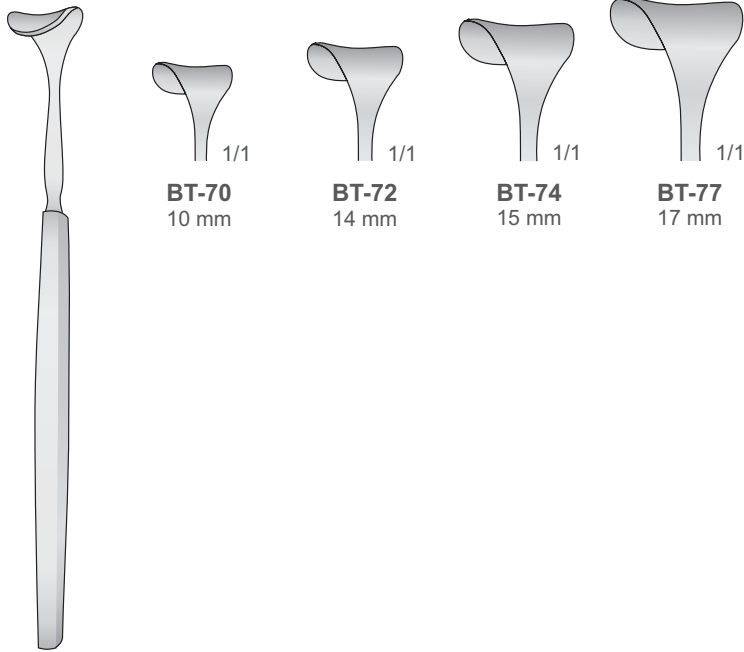

BT-70
10 mm

BT-72
14 mm

BT-74
15 mm

BT-77
17 mm

DESMARRES
BT-70/BT-77
140 mm

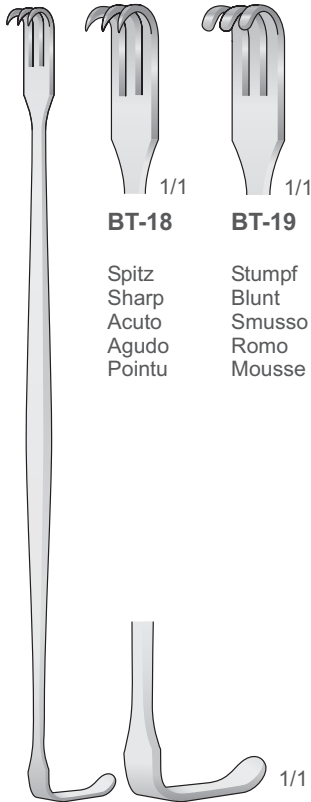

BT-18

BT-19

Spitz
Sharp
Acuto
Agudo
Pointu

Stumpf
Blunt
Smusso
Romo
Mousse

SEAN-MILLER
BT-18/BT-19
160 mm

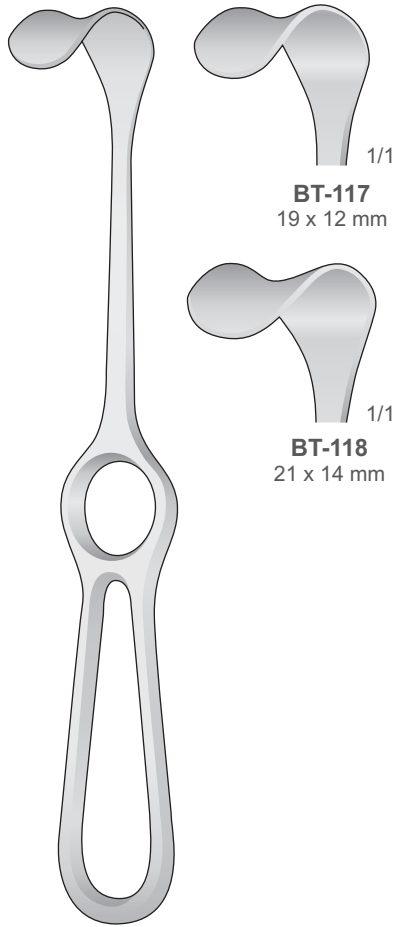

BT-117
19 x 12 mm

BT-118
21 x 14 mm

KOCHER
BT-117/BT-118
205 mm

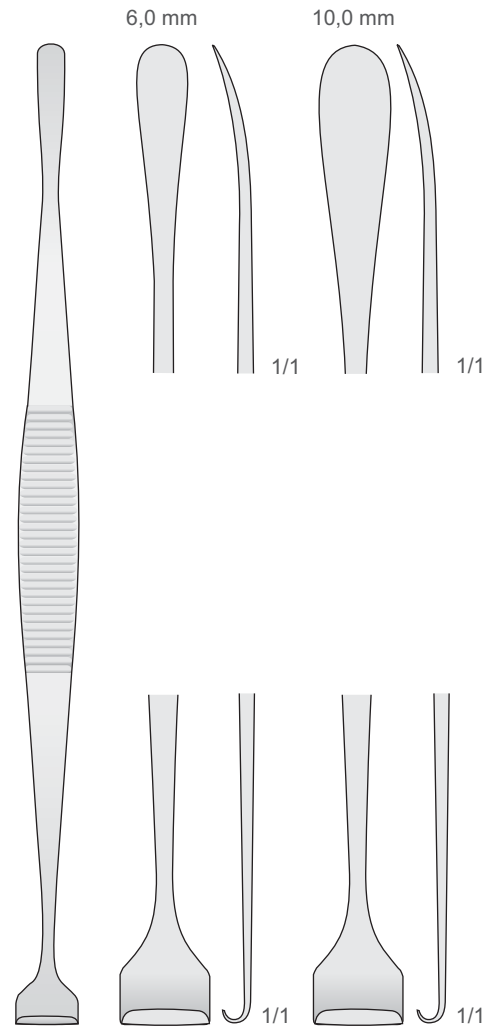

6,0 mm

10,0 mm

HURD
BT-1/BT-2
220 mm

12 mm

12 mm



Wundhaken
Retractors
Divaricatori
Separadores
Ecarteurs

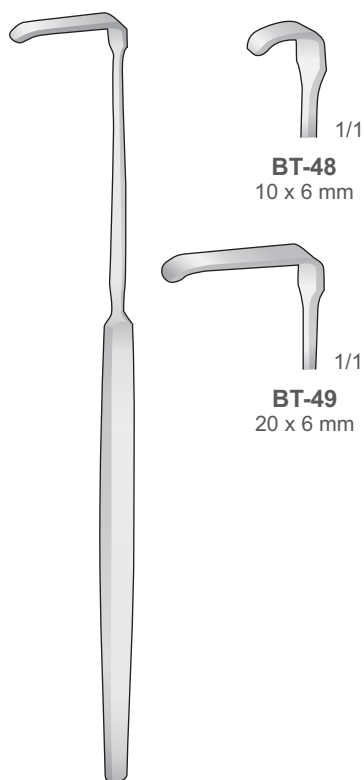

BT-48
10 x 6 mm

BT-49
20 x 6 mm

SENN GREEN
BT-48/BT-49
160 mm

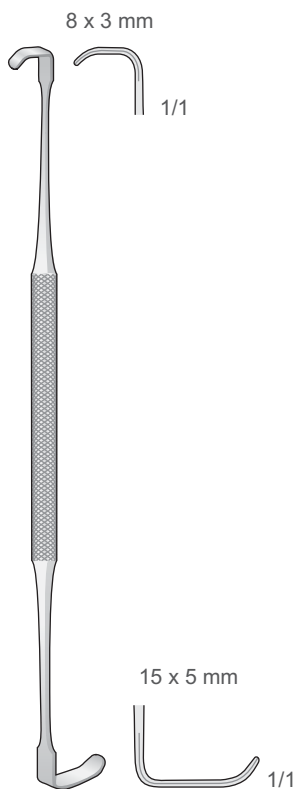

RAGNELL
BT-27
140 mm

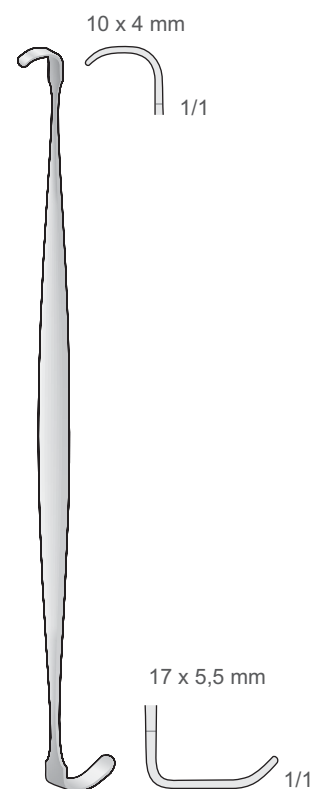

RAGNELL-DAVIS
BT-26
140 mm

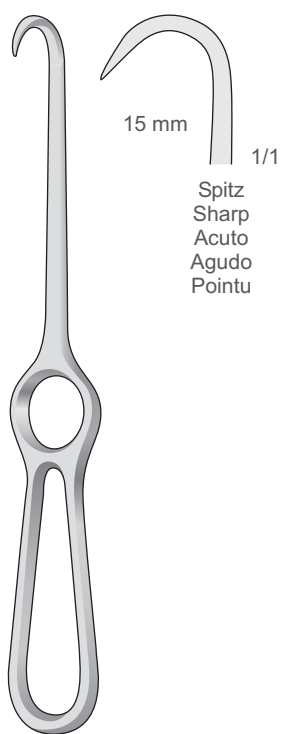

Spitz
Sharp
Acuto
Agudo
Pointu

KOCHER
BT-139
205 mm

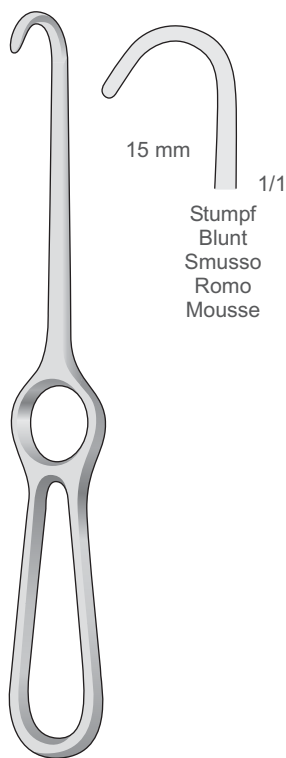

Stumpf
Blunt
Smusso
Romo
Mousse

KOCHER
BT-140
220 mm



LAHEY
BT-109
195 mm

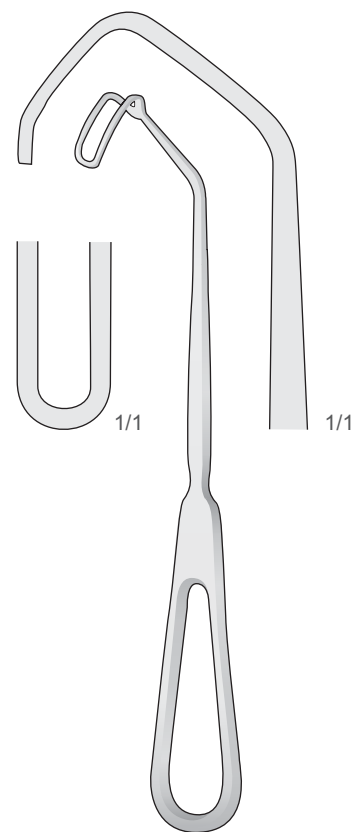

CUSHING
BT-29
200 mm



Wundhaken
Retractors
Divaricatori
Separadores
Ecarteurs

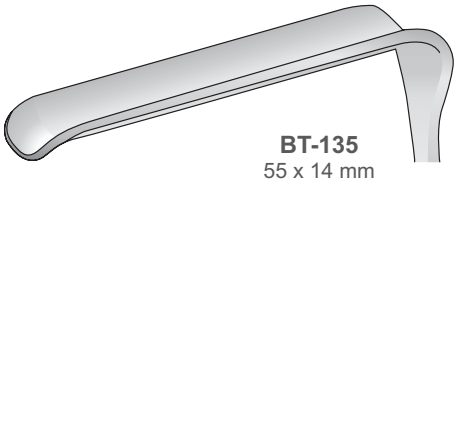
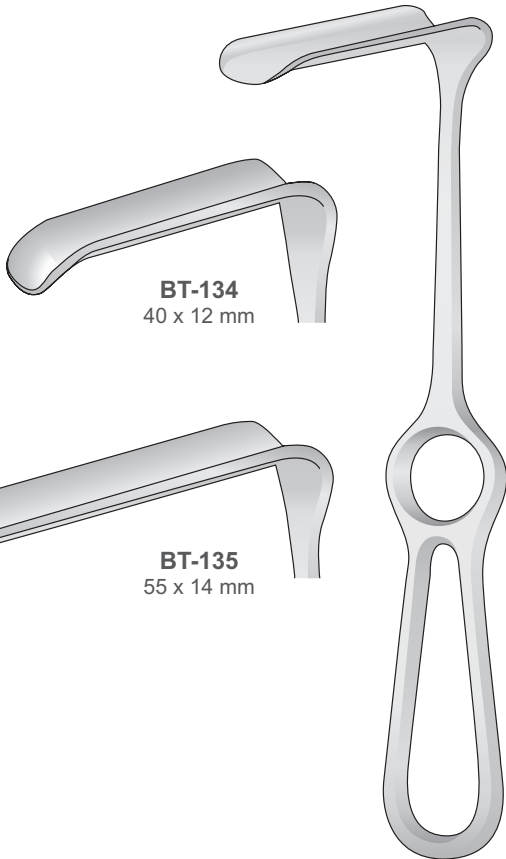
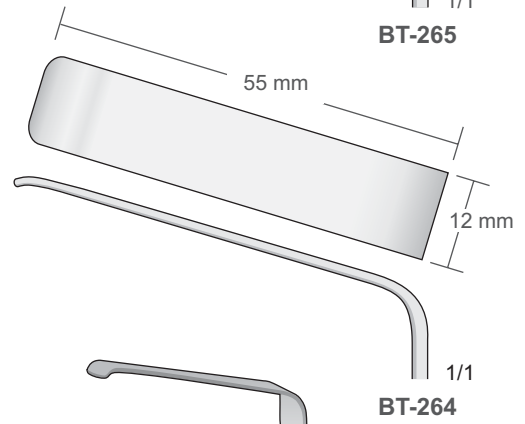
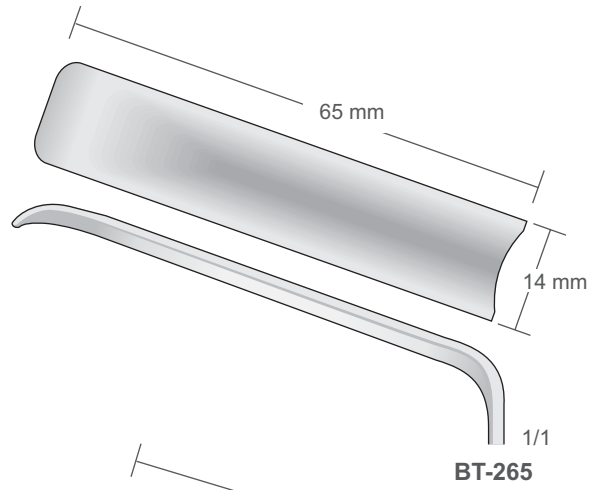

DOCKHORN
BT-134/BT-135
210 mm

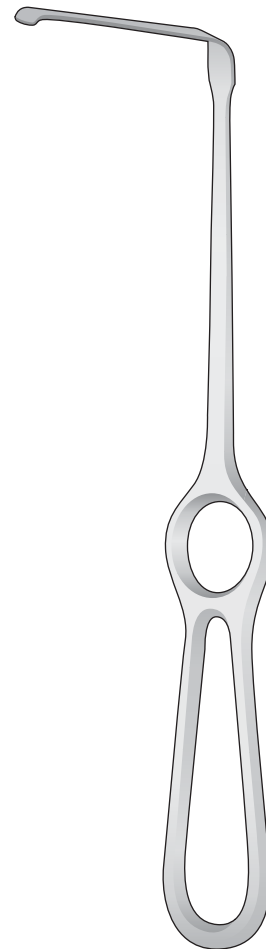



Wundhaken
Retractors
Divaricatori
Separadores
Ecarteurs

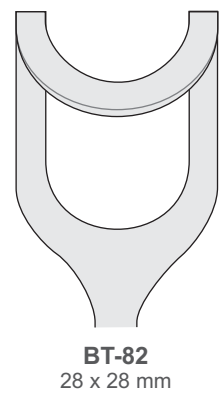
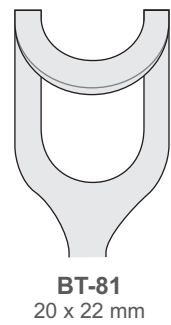
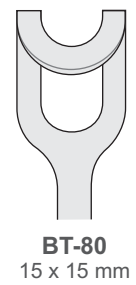
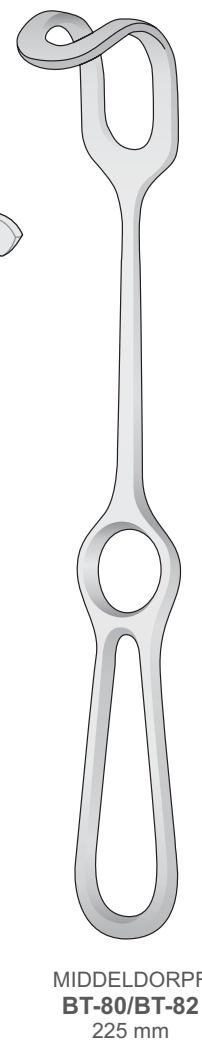
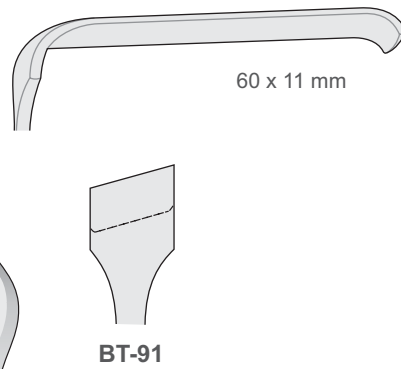
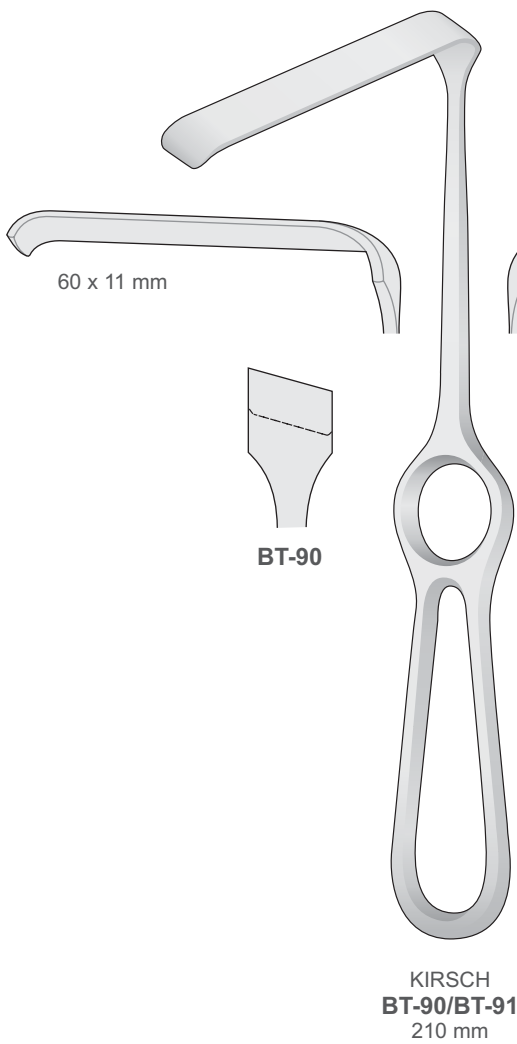



Wundhaken
Retractors
Divaricatori
Separadores
Ecarteurs

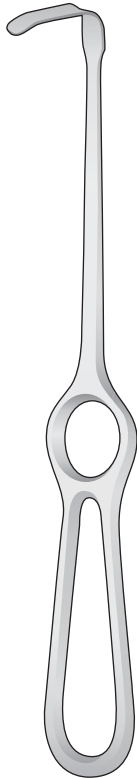

OBWEGESER
BT-152/BT-157
220 mm

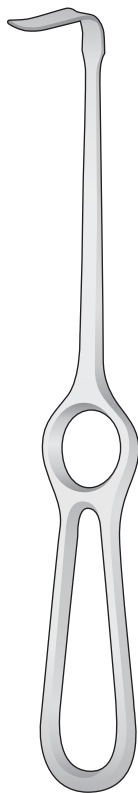

OBWEGESER
BT-92/BT-100
220 mm



BT-152
25 x 7 mm

1/1



BT-153
31 x 10 mm

1/1

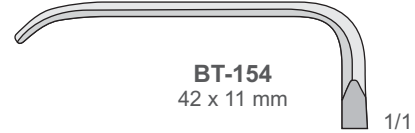

BT-154
42 x 11 mm

1/1

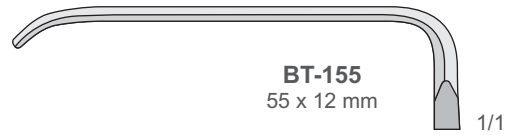

BT-155
55 x 12 mm

1/1

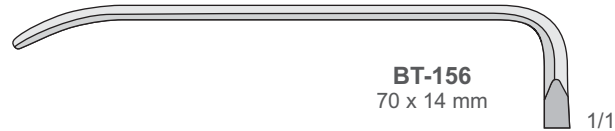

BT-156
70 x 14 mm

1/1

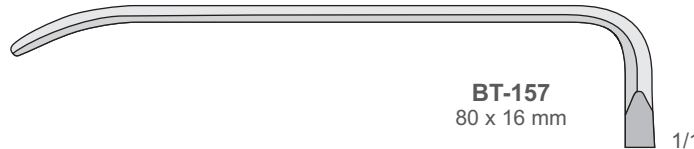

BT-157
80 x 16 mm

1/1

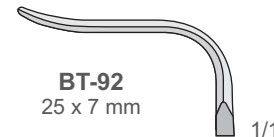

BT-92
25 x 7 mm

1/1

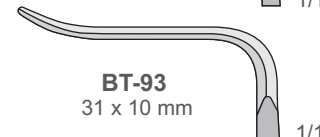

BT-93
31 x 10 mm

1/1

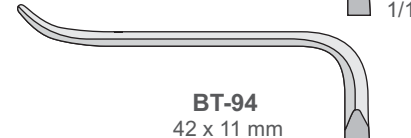

BT-94
42 x 11 mm

1/1

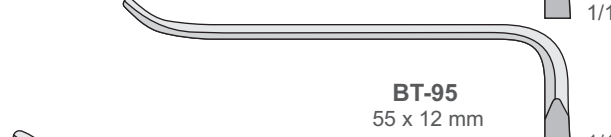

BT-95
55 x 12 mm

1/1

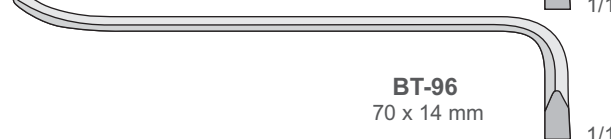

BT-96
70 x 14 mm

1/1

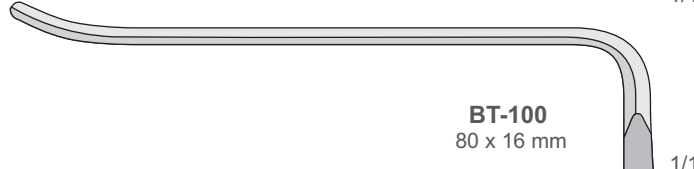

BT-100
80 x 16 mm

1/1



Wundhaken
Retractors
Divaricatori
Separadores
Ecarteurs

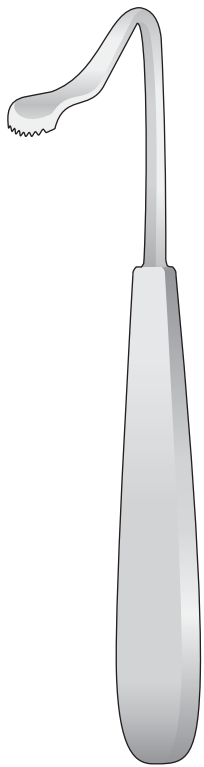

BOWLED-HENRY
DO-175
170 mm

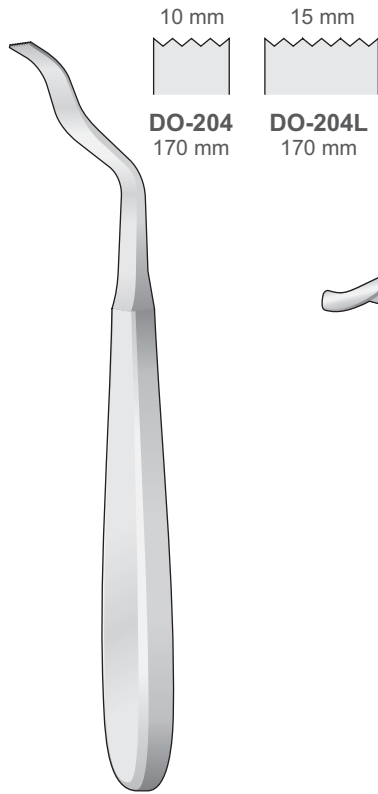

DO-204/DO-204L
170 mm

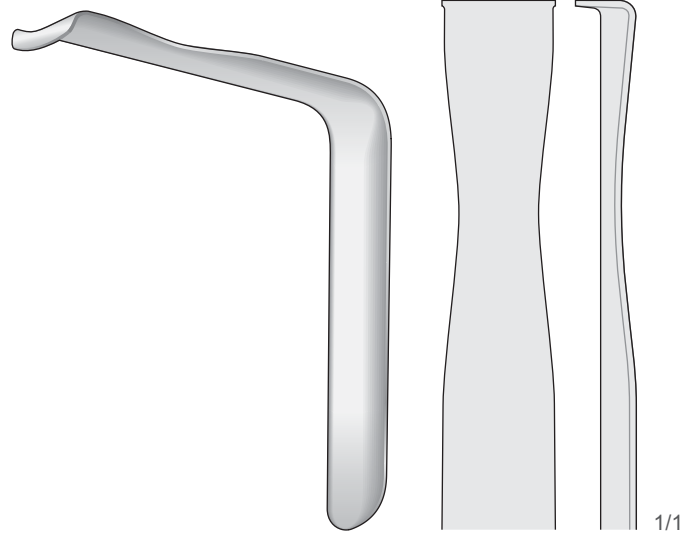

AUSTIN
DO-212
140 mm

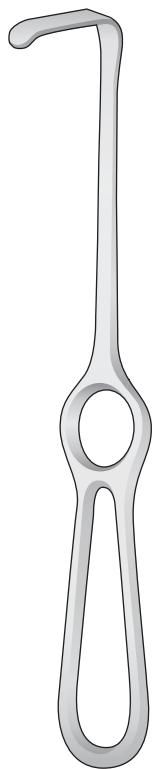

LANGENBECK
BT-33/BT-43
210 mm

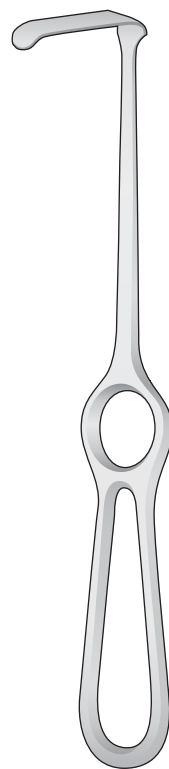
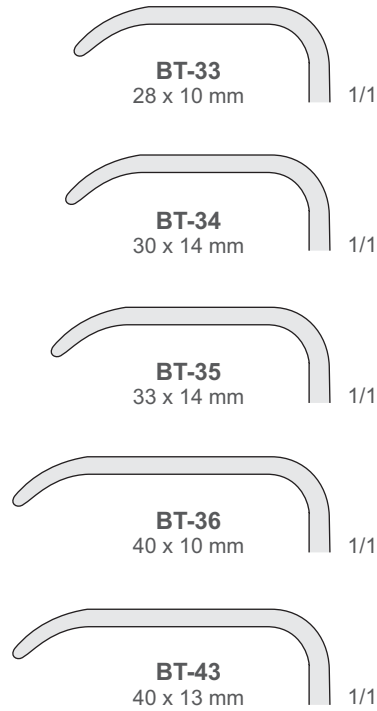

KOCHER-LANGENBECK
BT-60/BT-260
215 mm

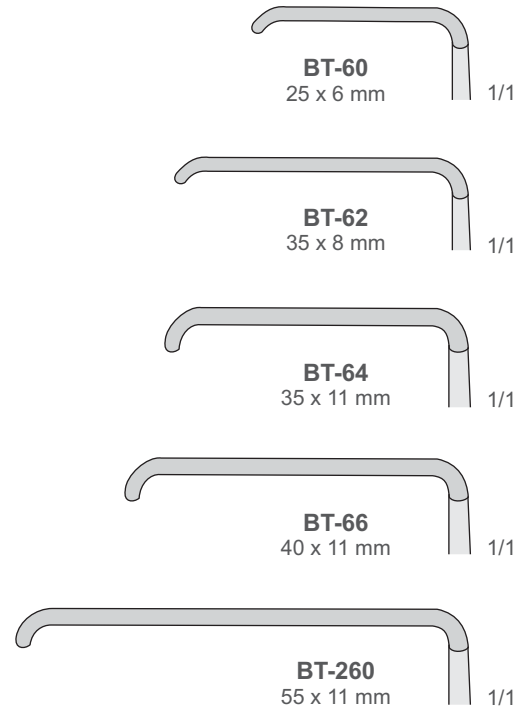



Wundhaken
Retractors
Divaricatori
Separadores
Ecarteurs

Rostfrei - Stainless Steel
Acciaio - Acero - Acer

Biegsam - Malleable
Malleabili - Maleables
Souples

OM-85
Kompletset mit 3 Spatel
Set complete with 3 spatulas
Set completo con 3 spatole
Set completos con 3 espátulas
Set complete avec 3 spatules
OM-80 + OM-81 + OM-82

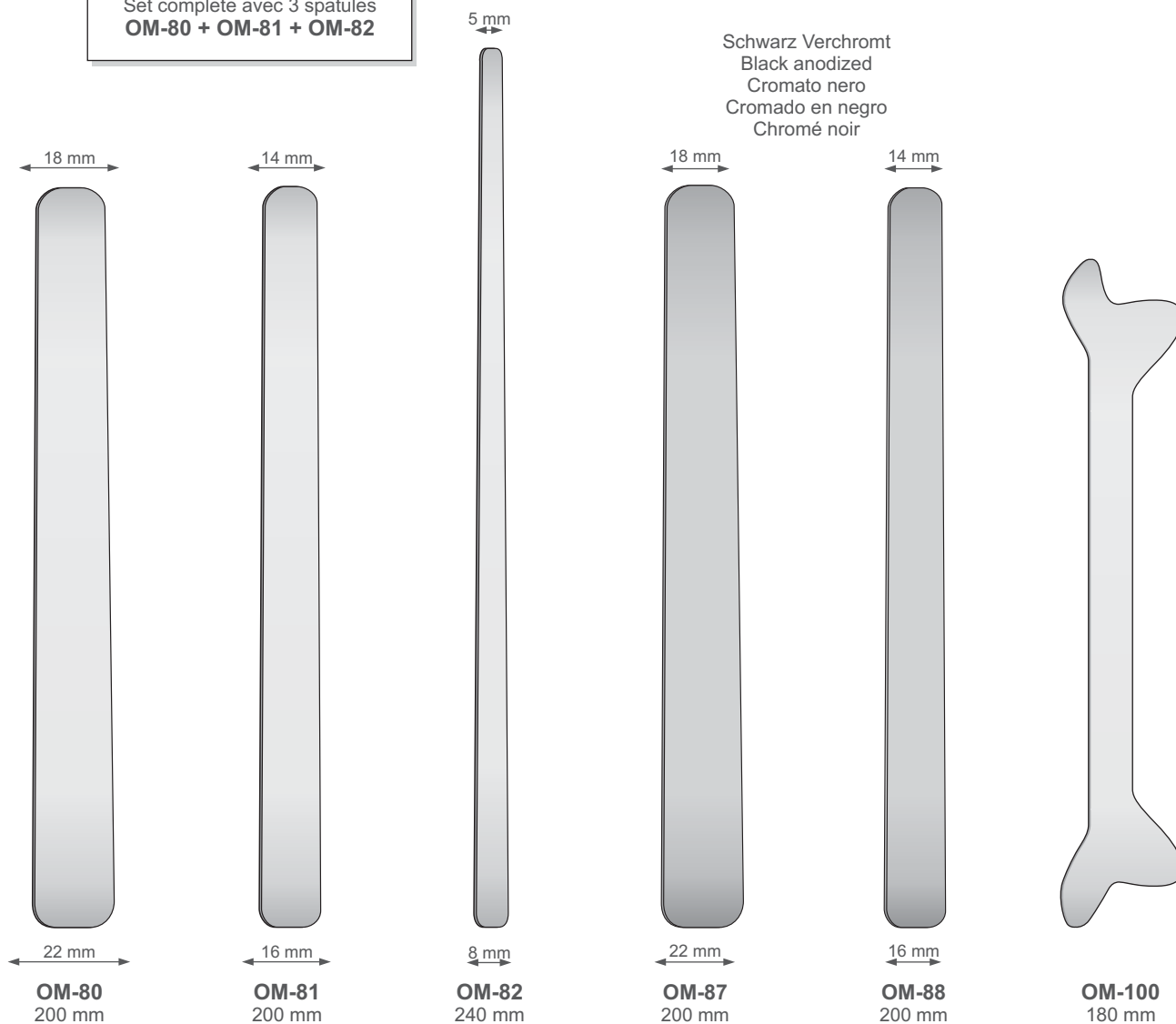



Wundhaken
Retractors
Divaricatori
Separadores
Ecarteurs

Zungendrucker
Tongue Depressors
Abbassalingua
Abajalenguas
Abaisse langue

Kinnhalter
Chin Holder
Divaricatore per mento
Separador para menton
Ecarteur pour menton

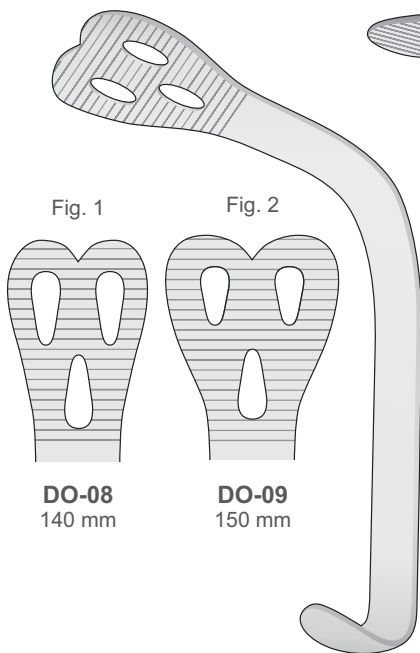
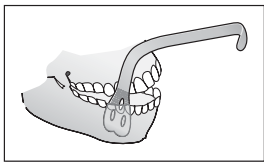

Fig. 1

Fig. 2

DO-08
140 mm

DO-09
150 mm

WIEDER
DO-08/DO-09

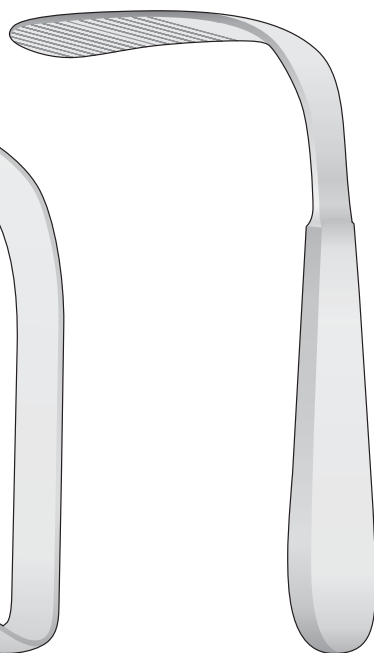

TOBOLD
OM-08
145 mm

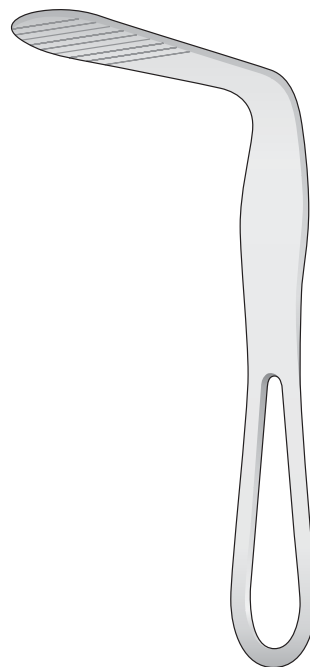

HARTMANN
OM-06
150 mm

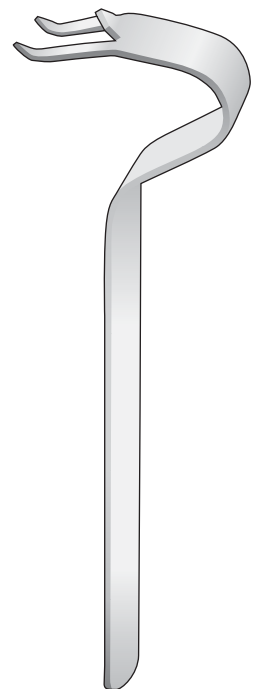

OBWEGESER
DO-40
155 mm



Wundhaken
Retractors
Divaricatori
Separadores
Ecarteurs

Ramushaken für Spina Nasalis
Ramus Retractor for nasal spine
Divaricatori per spina nasalis
Separadores para spina nasalis
Ecarteurs pour spina nasalis



42 x 10 mm

1/1



70 x 11 mm

1/1

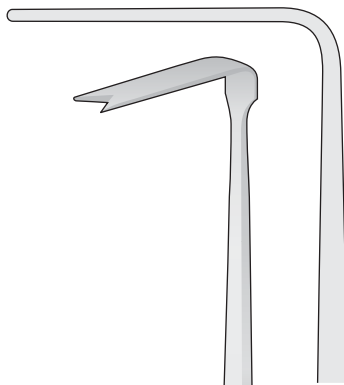

1/1

OBWEGESER
BT-67
220 mm

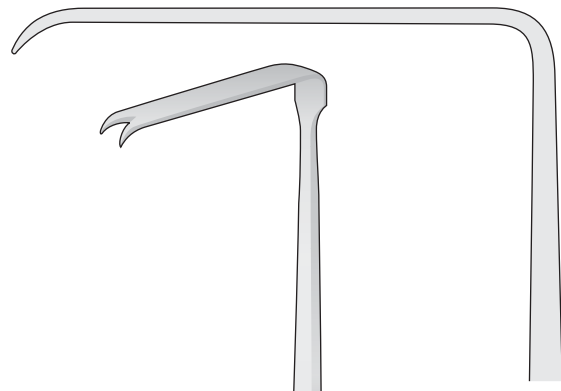

1/1

OBWEGESER
BT-68
220 mm



Mundsperrer
Mouth gags
Aprobocas
Abrebocas
Ecarteur buccal



Paar Einsätze aus Silikon für:
Pair of silicone inserts for:
Coppia di inserti in silicone per:
Pareja de inserto de silicone para:
Paire de inserts en silicon pour:

OM-40 - OM-41

Ø 8 mm

Ø 11 mm



OM-40R
30 mm

OM-41R
30 mm

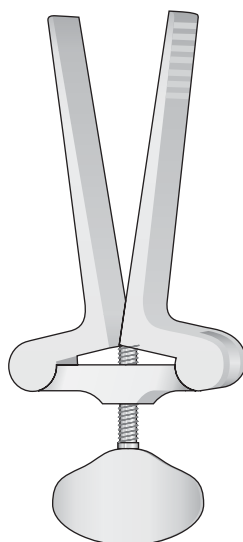

HEISTER
OM-62
135 mm

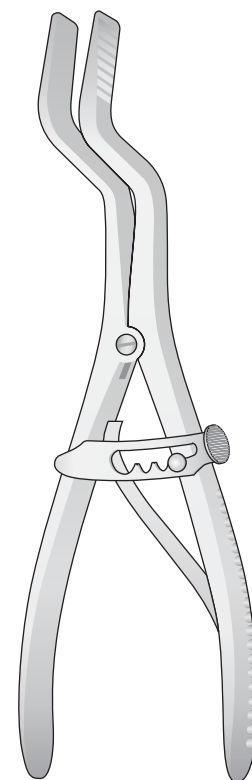

ROSER KÖNIG
OM-60
185 mm

Für Erwachsene - For adults
Per adulti - Para adultos
Pour adultes

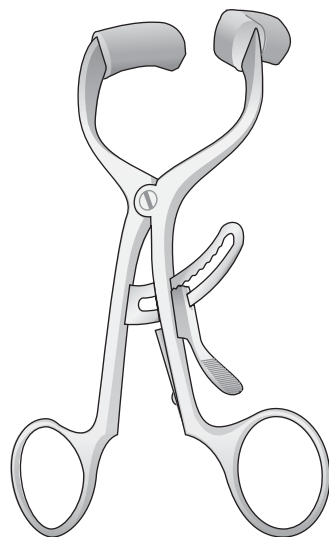

MOLT
DOYEN-JANSEN
OM-41
140 mm

Für Erwachsene - For adults
Per adulti - Para adultos
Pour adultes

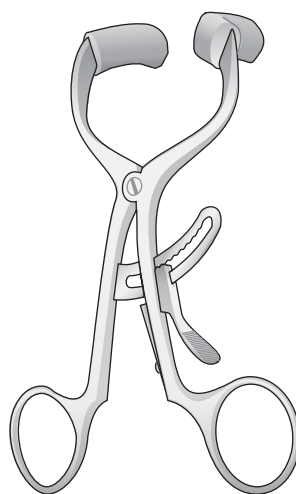

MOLT
DOYEN-COLLIN
OM-40
120 mm

Für Kinder
For children
Per bambini
Para niños
Pour enfants

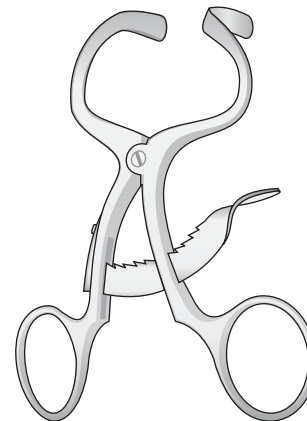

MOLT
OM-42
100 mm



Mundsperrer
Mouth gags
Atribocca
Abrebocas
Ecarteur buccal

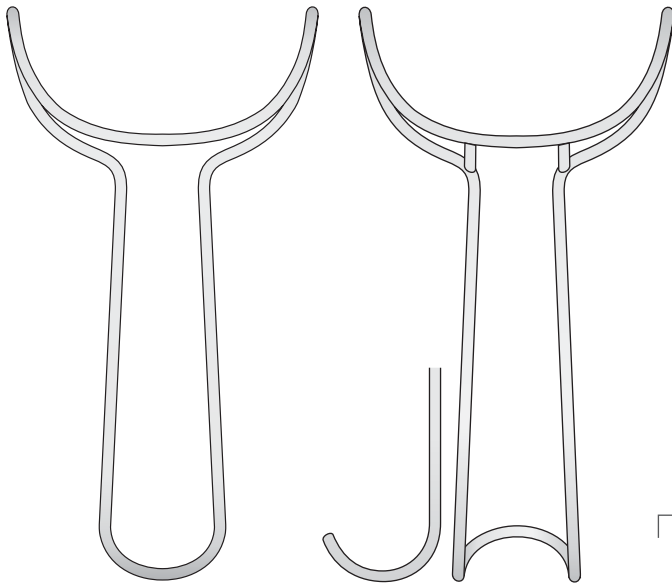

OM-90
150 mm

OM-91
140 mm

Abhalter für gesamten Ober- bzw. Unterkiefer
Retractor for complete upper resp. Lower jaws
Retrattore per arcata superiore e inferiore intera
Separadores para quijadas enteras inferiores y superiores
Ecarteurs pour machoires complètes inférieures et supérieures

- OM-74** Fig. 0 100 x 95 mm
- OM-75** Fig. 1 115 x 105 mm
- OM-76** Fig. 2 115 x 110 mm
- OM-77** Fig. 3 125 x 115 mm

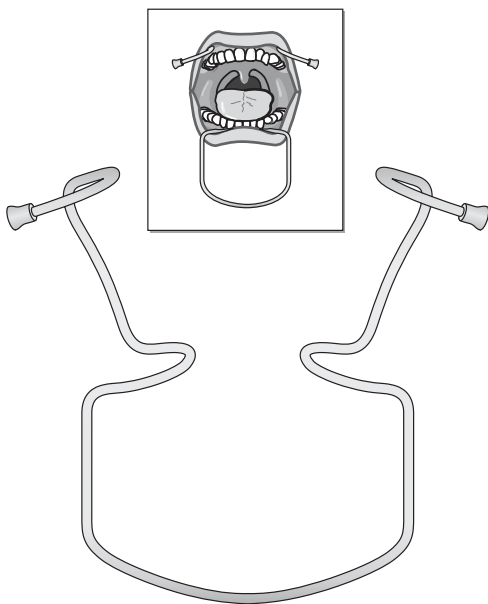

ORINGER
OM-74/OM-77

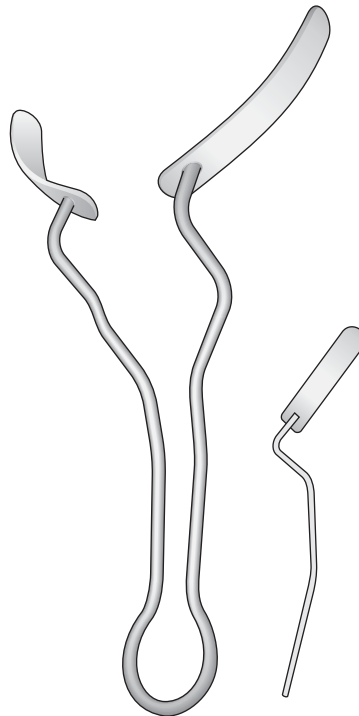

MATY
OM-97
170 mm

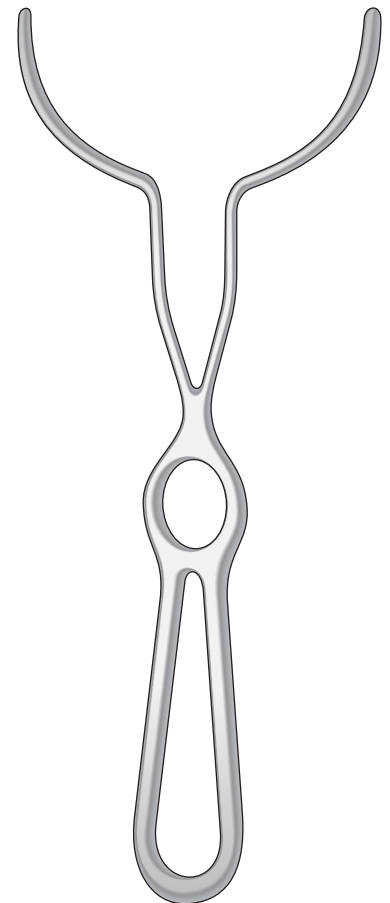

OM-96
230 mm



Wundhaken
Retractors
Divaricatori
Separadores
Ecarteurs

BT-283
Set completo
Set complete
Komplettsset
Set complet
Set completo
BT-284 + BT-285 + BT-286

29 mm
26 mm
22 mm

28 mm
38 mm
44 mm

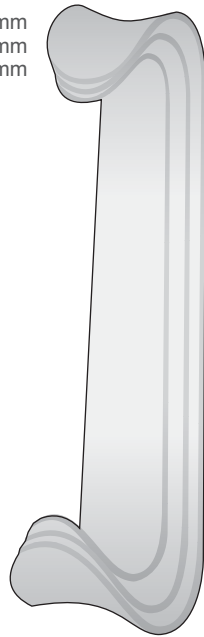

**ROUX
BT-283**
165 mm



**ROUX
BT-284**
20x22 mm
25x28 mm

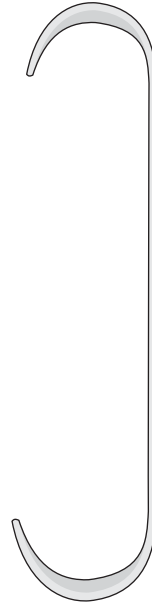

**ROUX
BT-285**
23x26 mm
29x38 mm

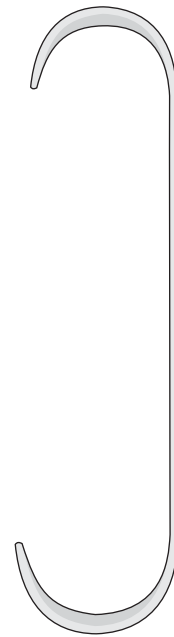

**ROUX
BT-286**
29x29 mm
34x44 mm

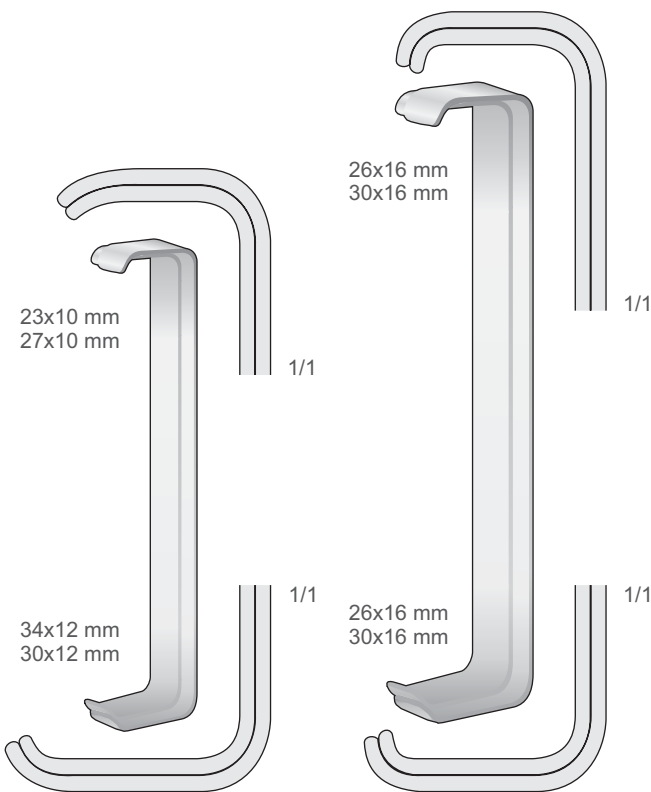

23x10 mm
27x10 mm

26x16 mm
30x16 mm

34x12 mm
30x12 mm

26x16 mm
30x16 mm

**FARABEUFT
BT-20**
120 mm

**FARABEUFT
BT-25**
150 mm

20x22 mm

**ROUX-MAGNUS
BT-287**
150 mm

23x26 mm

**ROUX-MAGNUS
BT-288**
160 mm

29x29 mm

**ROUX-MAGNUS
BT-289**
170 mm



Wangenhalter
Cheek Retractors
Divaricatori per guance
Separador para mejillas
Ecarteurs des joues

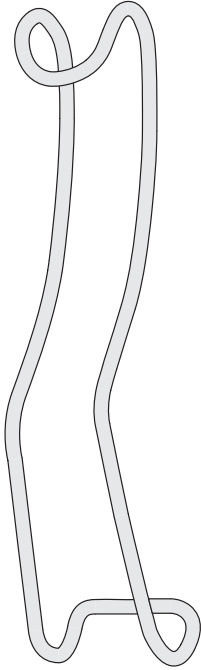

STERNBERG
OM-50
160 mm



STERNBERG
OM-52
160 mm

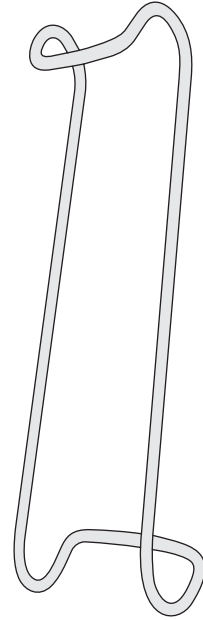

COLUMBIA
OM-67
140 mm

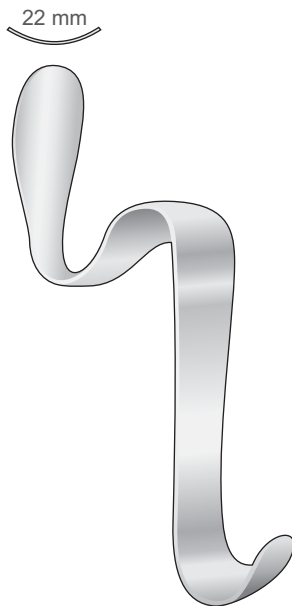

BISHOP
OM-61
130 mm



MINNESOTA
OM-55
140 mm



CAWOOD-MINNESOTA
OM-66
160 mm



Wundhaken
Retractors
Divaricatori
Separadores
Ecarteurs

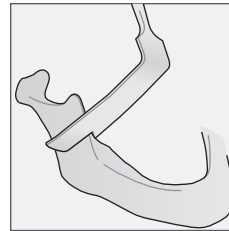

Ramus Retraktoren Recht
Ramus Retractor Right
Retrattore Ramus destro
Separadores Ramus derecho
Ecarteur Ramus droites

Ramus Retraktoren Link
Ramus Retractor Left
Retrattore Ramus sinistro
Separadores Ramus izquierdo
Ecarteur Ramus gauches

8 mm

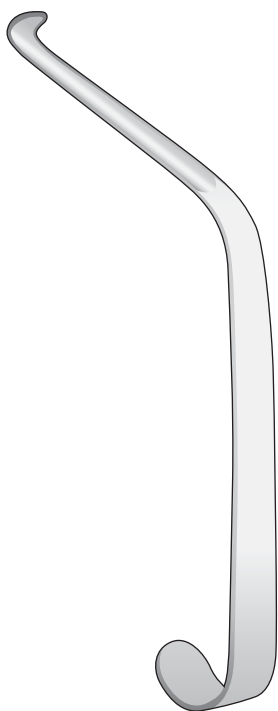

OBWEGESER
DO-41
165 mm

10 mm

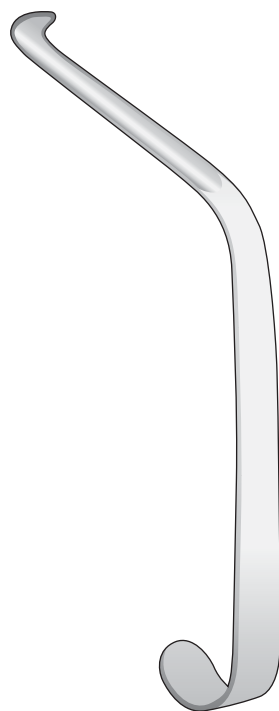

OBWEGESER
DO-142
165 mm



MISCH
BT-158
210 mm

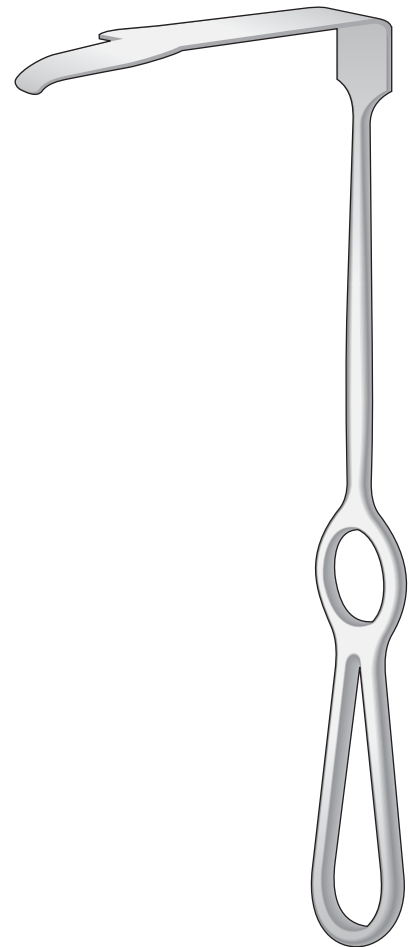

MISCH
BT-159
210 mm



Mundsperrer
Mouth Gags
Apribocca
Abrebocas
Ecarteur buccal

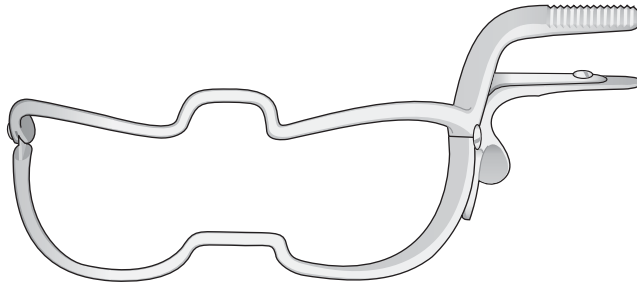

WHITEHEAD-JENNINGS

- OM-136** 90 mm
- OM-137** 110 mm
- OM-138** 130 mm
- OM-139** 150 mm

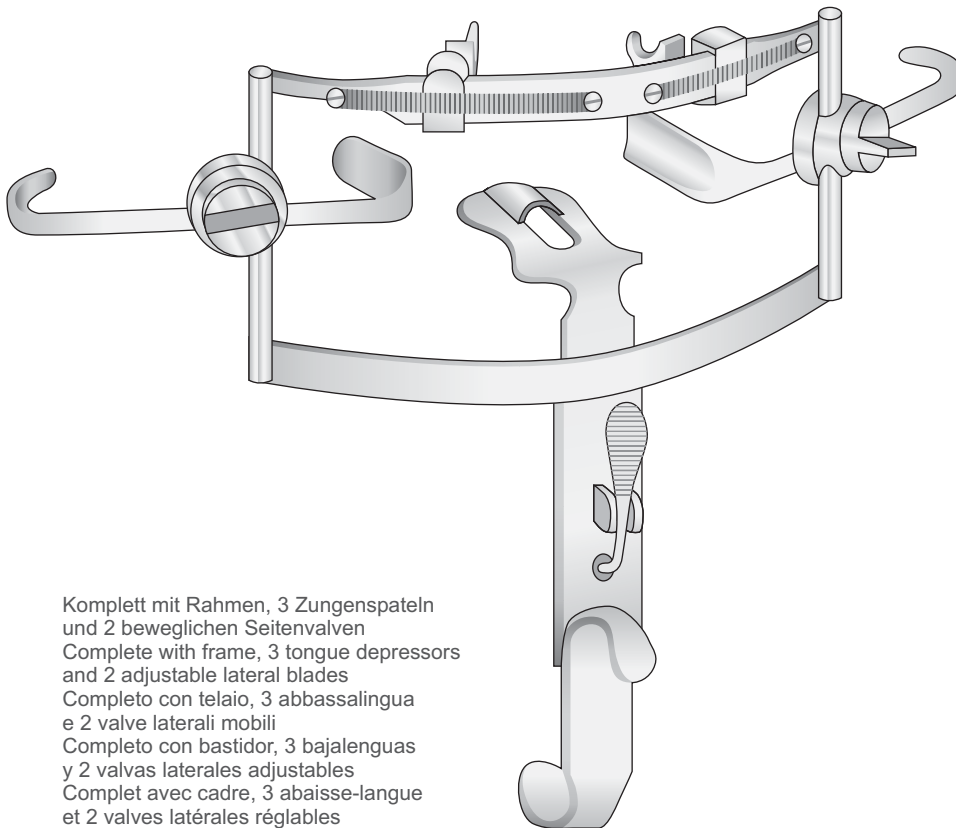

Komplett mit Rahmen, 3 Zungenspateln
und 2 beweglichen Seitenvälven
Complete with frame, 3 tongue depressors
and 2 adjustable lateral blades
Completo con telaio, 3 abbassalingua
e 2 valve laterali mobili
Completo con bastidor, 3 bajalenguas
y 2 valvas laterales ajustables
Complet avec cadre, 3 abaisse-langue
et 2 valves latérales réglables

DINGMANN
OM-110
Set completo

DINGMANN

Zungenspatel
Tongue depressor
Abbassalingua
Bajalengua
Abaisse langue

Fig. 1

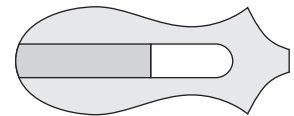

OM-112
65 x 25 mm

Fig. 2

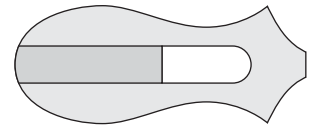

OM-113
70 x 29 mm

Fig. 3

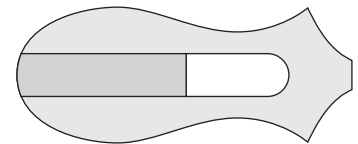

OM-114
80 x 32 mm



Wundhaken
Retractors
Divaricatori
Separadores
Ecarteurs

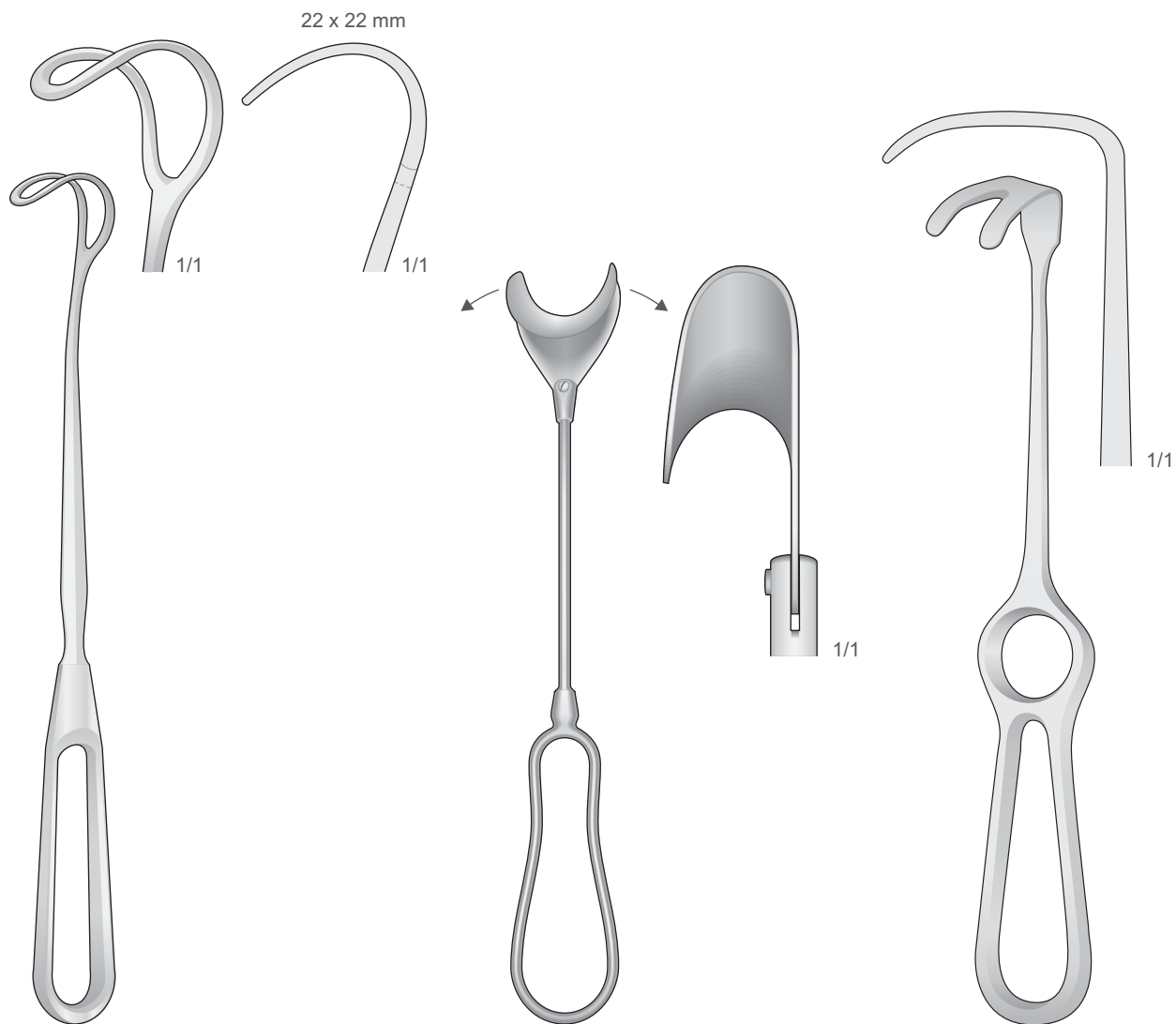

GREENE
BT-131
225 mm

BT-132
200 mm

WASSMUND
BT-69
220 mm



Zungenspatel - Zungenzangen
Tongue Depressors - Tongue Holding Forceps
Abbassalingua - Pinze tiralingua
Abaja lenguas - Pinzas tira-lengua
Abaisse langues - Pincés tire-langue

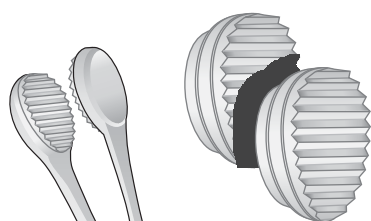
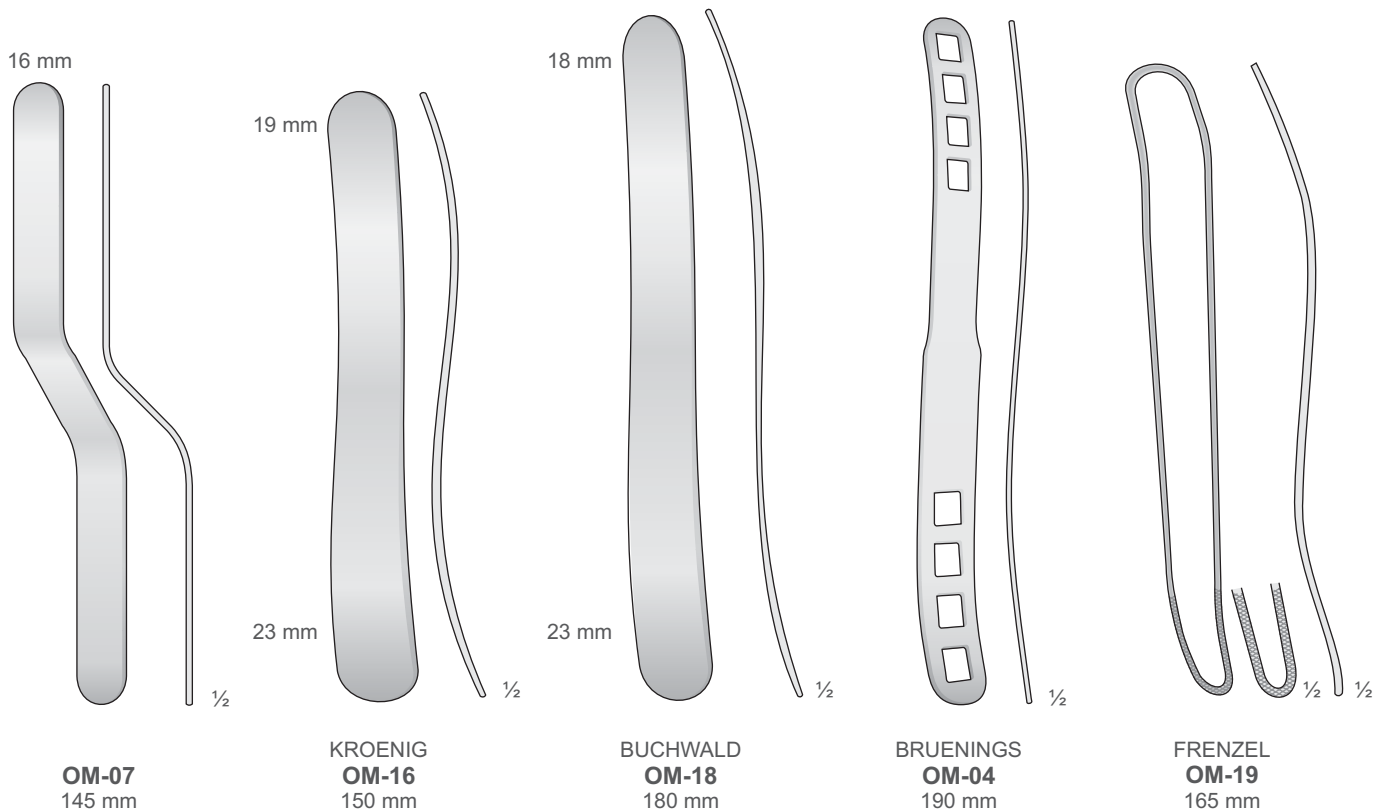

OM-44

1 Paar Ersatzgummi
1 Pair of rubber pads
Gommini di ricambio 2 pezzi
1 Paar placas de caucho
1 Paire de mors caoutchouc

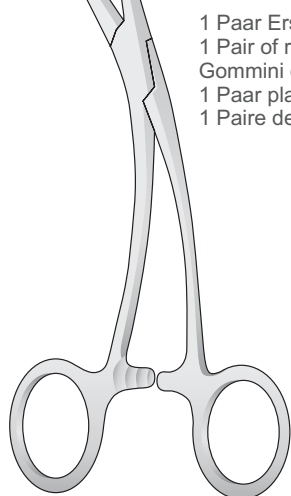

YOUNG OM-45
160 mm

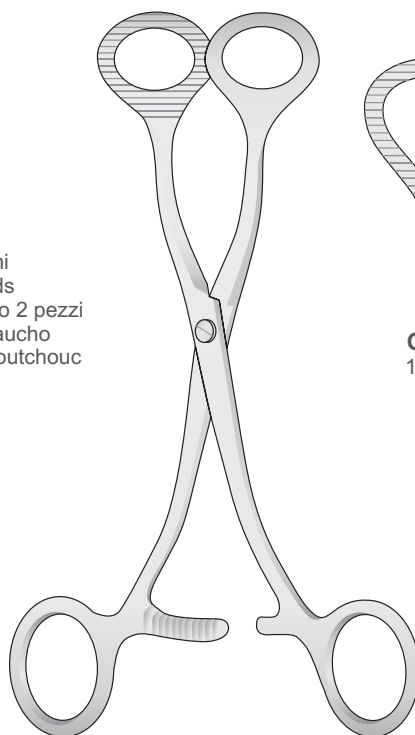

COLLIN OM-10/OM-30

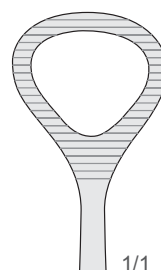

1/1
OM-30
165 mm

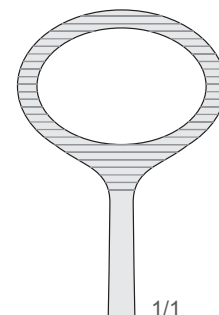

1/1
OM-10
170 mm



Kette und Mundstutzen
Chain and Mouth Props
Catene e Apribocca
Cadena y Abrebocas
Chaîne et Ouvre Bouche

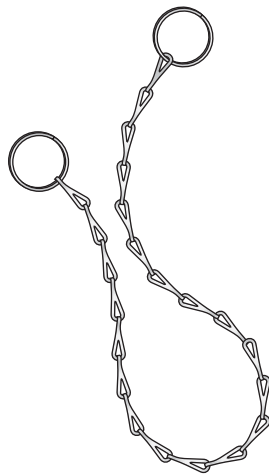

KE-20
200 mm



KE-40
400 mm

Dampfsterilisation bis 134°C
Autoclavable to 134°C
Autoclavabile a 134°C
Autoclave hasta 134°C
Autoclavable jusqu'à 134°C

Packung mit 2 Stück
Package with 2 units
Confezione da 2 pezzi
Paquete con 2 unidades
Boîte avec 2 pièces

Schwarzer Gummi
Black Rubber
Gomma nera
Caucho negro
Caoutchouc noir

Schwarzer Gummi
Black Rubber
Gomma nera
Caucho negro
Caoutchouc noir

Schwarzer Gummi
Black Rubber
Gomma nera
Caucho negro
Caoutchouc noir



OM-70
SMALL
Klein, für Kinder
Small, for children
Piccolo, per bambini
Pequeño, para niños
Petit, pour enfants



OM-71
MEDIUM
Normal, für Erwachsene
Regular, for adults
Normale, per adulti
Regular, para adultos
Regulier, pour adultes

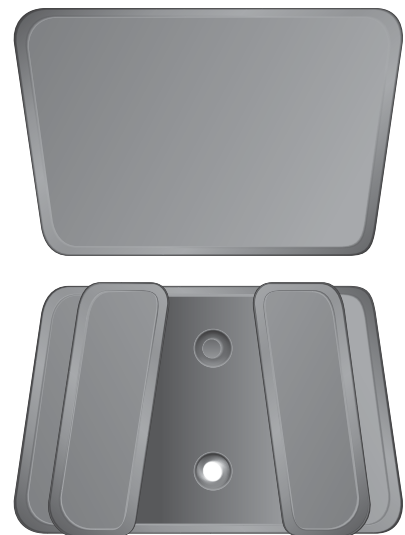

OM-72
LARGE
Groß, für Erwachsene
Large, for adults
Grande, per adulti
Grande, para adultos
Grand, pour adultes

.9

Implantologie
Implantology
Implantologia
Implantologia
Implantologie

Zahnärztliche Chirurgie
Dental surgery
Chirurgia dentale
Cirugia dental
Chirurgie dentaire





Osteotome
Osteotomes
Osteotomi
Osteòtomos
Ostéotomes

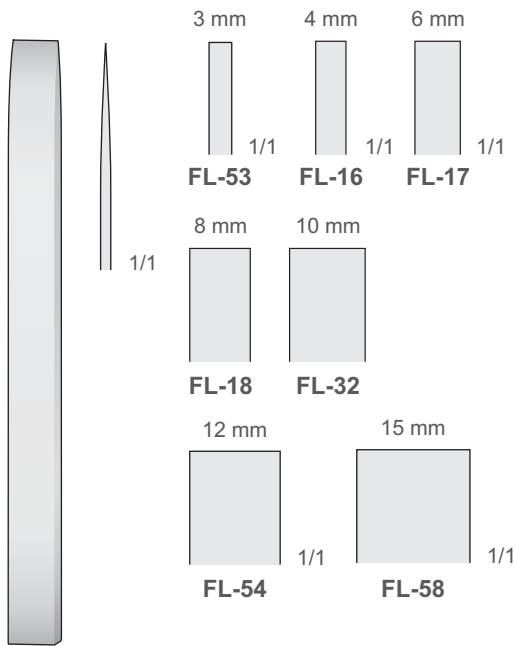

MINI-LAMBOTTE
FL-16/FL-58
125 mm



MINI-LAMBOTTE
FL-263/FL-269
170 mm

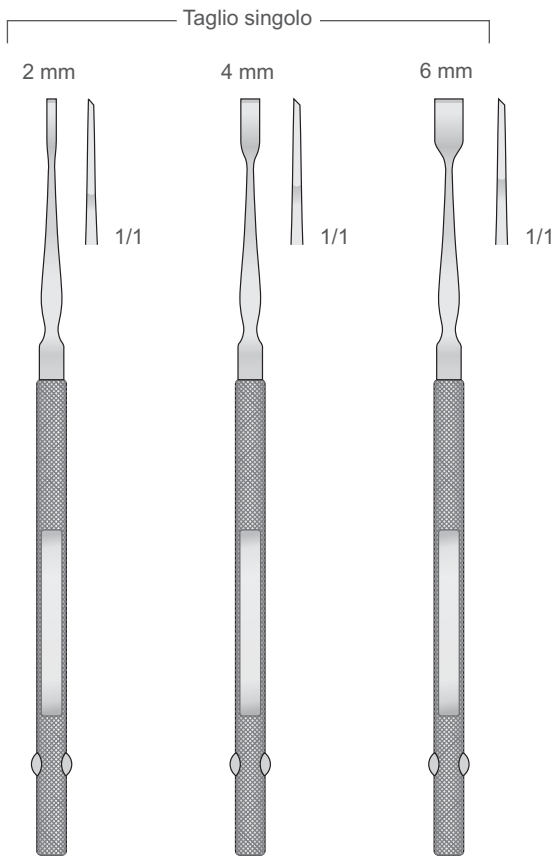

FREER
TG-10
160 mm

FREER
TG-11
160 mm

FREER
TG-12
160 mm

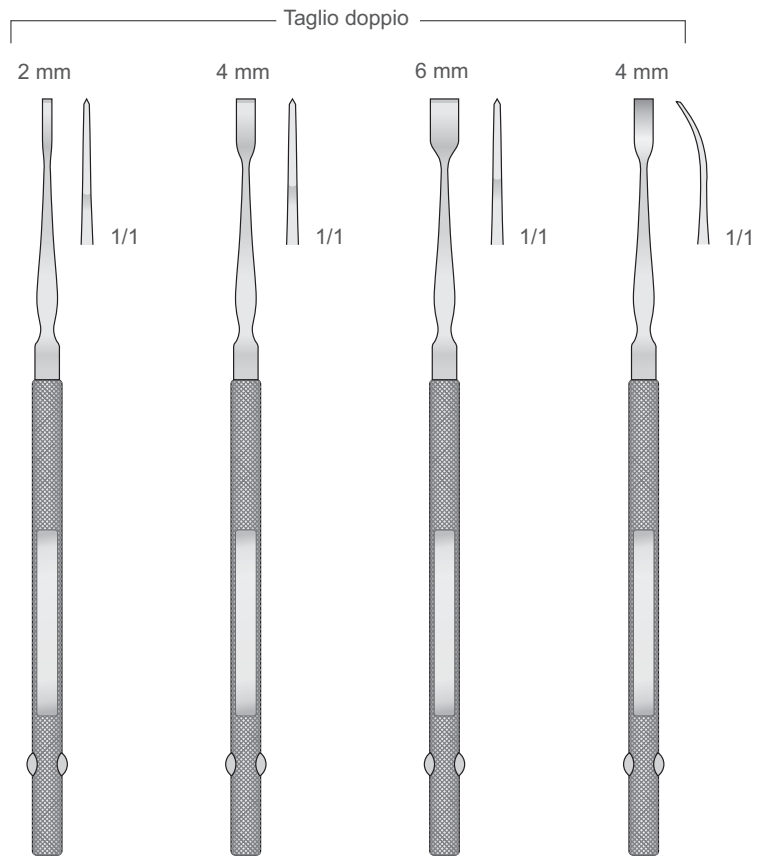

FREER
TG-20
160 mm

FREER
TG-21
160 mm

FREER
TG-22
160 mm

FREER
TG-23
160 mm



Osteotome - Hohlmeißel
Osteotomes - Gouges
Osteotomi - Scalpelli
Osteótomos - Cinceles
Ostéotomes - Scalpel

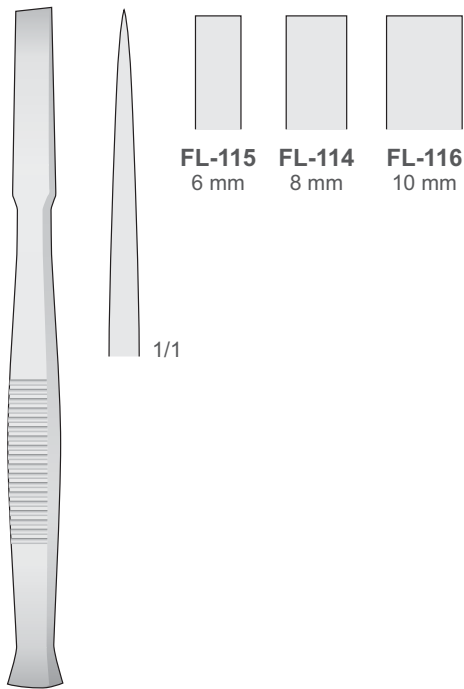

FL-115 6 mm
FL-114 8 mm
FL-116 10 mm

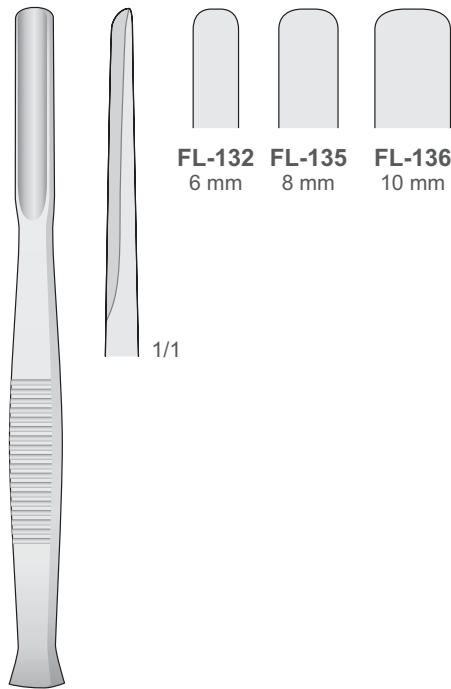

FL-132 6 mm
FL-135 8 mm
FL-136 10 mm

FL-114/FL-116
140 mm

FL-132/FL-136
140 mm

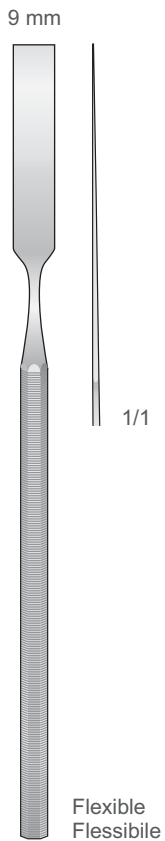

TG-15
170 mm

Flexible
Flessibile

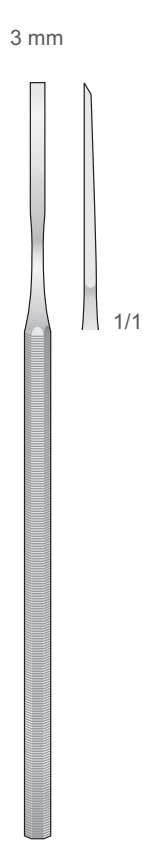

TG-30
155 mm

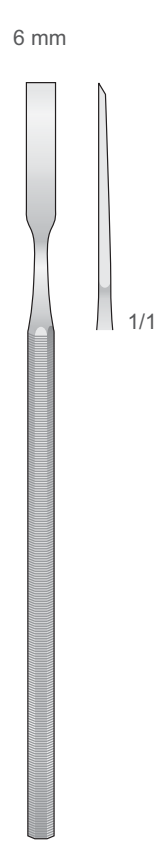

TG-31
155 mm

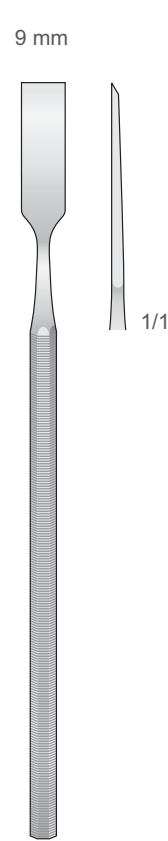

TG-32
155 mm

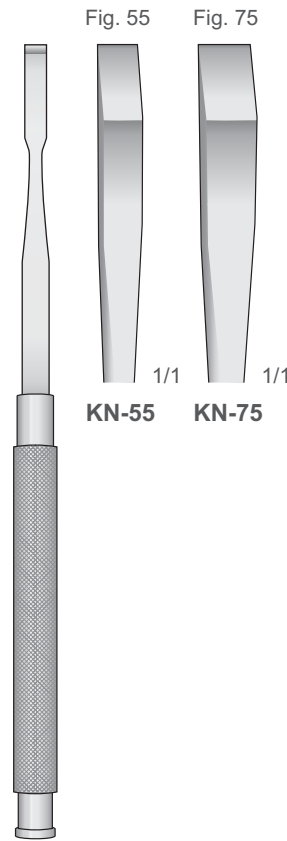

KRAMER-NEVINS
KN-55/KN-75
175 mm

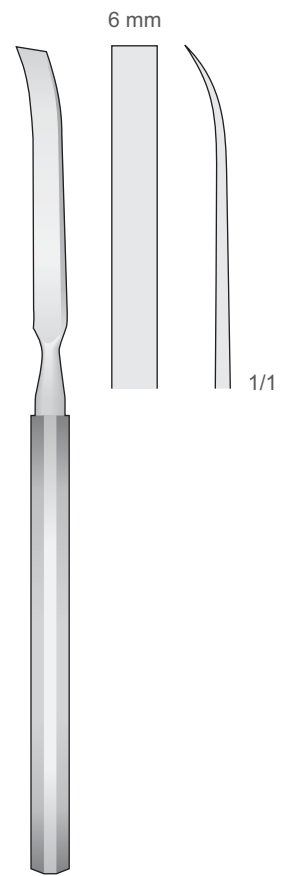

DO-196
180 mm



Osteotome - Hohlmeißel
Osteotomes - Gouges
Osteotomi - Scalpelli
Osteótomos - Cinceles
Ostéotomes - Scalpel

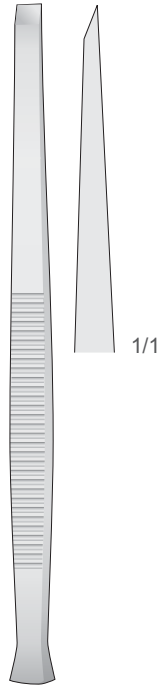

FL-13
3 mm

FL-14
4 mm

FL-15
5 mm

PARTSCH
FL-13/FL-15
140 mm

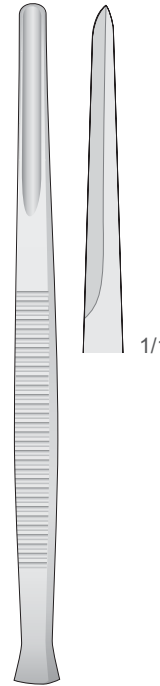

FL-03
3 mm

FL-04
4 mm

FL-05
5 mm

PARTSCH
FL-03/FL-05
140 mm

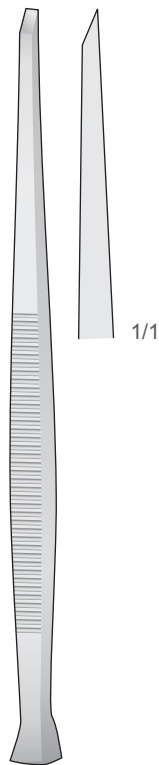

FL-177
3 mm

FL-183
6 mm

FL-179
4 mm

FL-184
7 mm

FL-181
5 mm

PARTSCH
FL-177/FL-184
170 mm

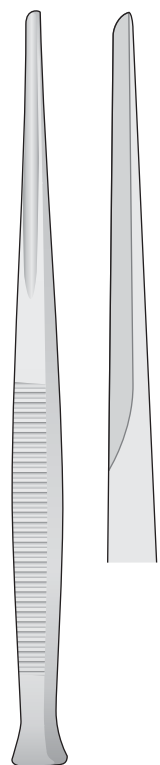

FL-185
3 mm

FL-188
6 mm

FL-186
4 mm

FL-189
7 mm

FL-187
5 mm

PARTSCH
FL-185/FL-189
170 mm



Osteotome - Meissel
 Osteotomes - Chisels
 Osteotomi - Scalpelli
 Osteótomos - Cinceles
 Ostéotomes - Burins

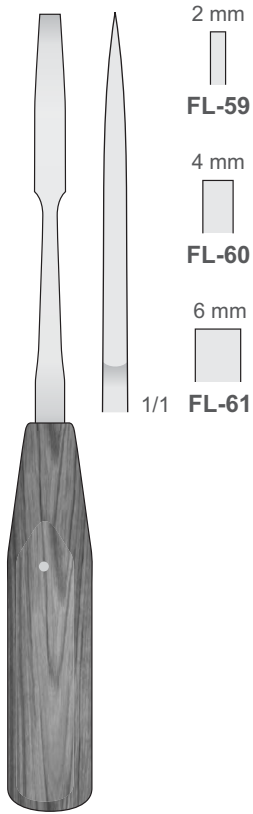

MINI-LEXER
FL-59/FL-61
 200 mm

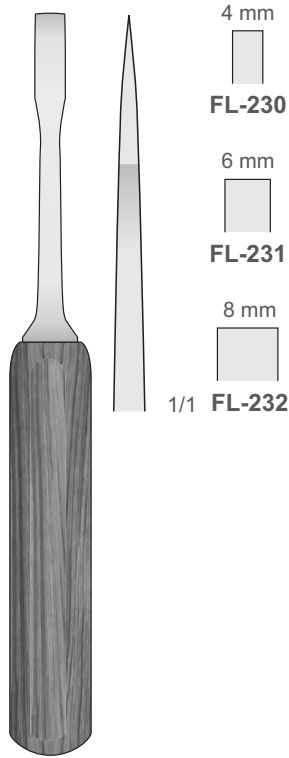

MINI-LEXER
FL-230/FL-232
 180 mm

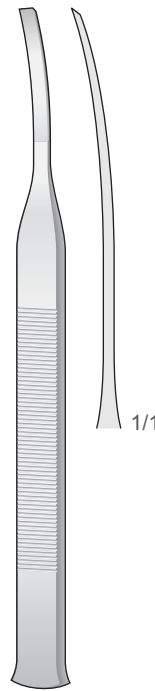

TESSIER
FL-411 5 mm
FL-412 7 mm
 160 mm

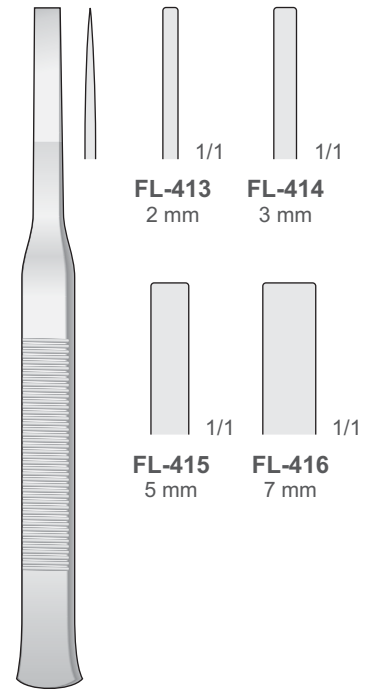

TESSIER
FL-413/FL-416
 160 mm

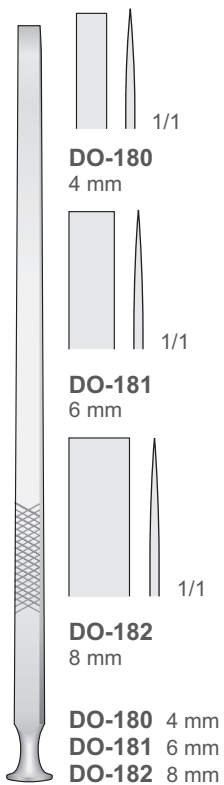

EPKER
DO-180/DO-182
 180 mm

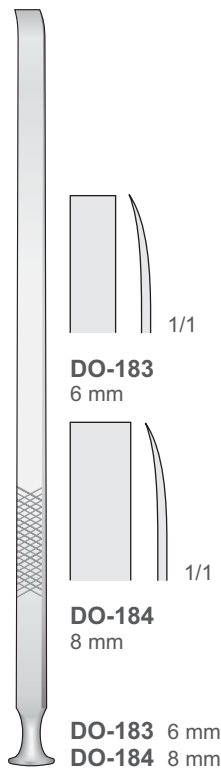

EPKER
DO-183/DO-184
 180 mm

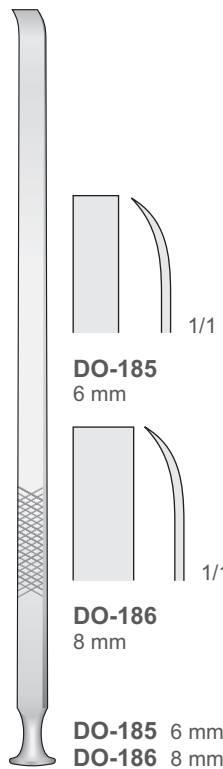

EPKER
DO-185/DO-186
 180 mm

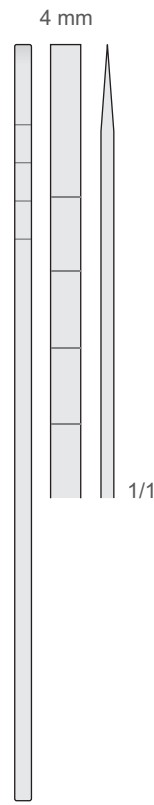

COTTLE
DO-140
 180 mm

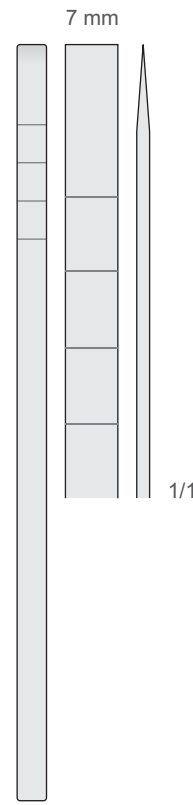

COTTLE
DO-141
 180 mm

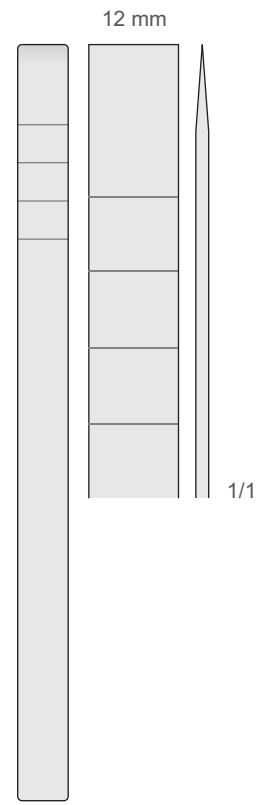

COTTLE
DO-143
 180 mm

Chirurgische Hämmer
Surgical mallets
Martelli chirurgici
Martillos quirurgicos
Maillets chirurgicaux

Ø 20 mm - 140 g



FL-01
165 mm

Ø 25 mm - 300 g

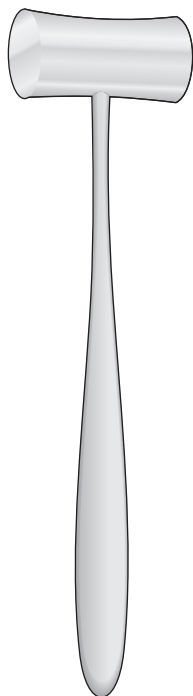

**LUCAE
FL-10M**
190 mm

Ø 27 mm - 135 g

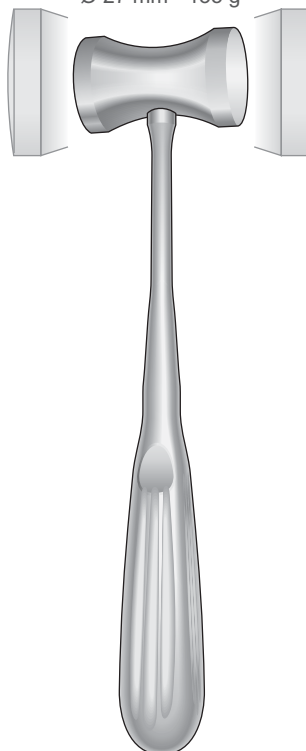

**HAJEK
FL-128**
200 mm

Ø 30 mm - 240 g



**COTTLE
FL-104**
185 mm

1 Seite flach - 1 Seite convex
1 Side flat - 1 Side convex
1 Lato piatto - 1 Lato convesso
1 Parte plana - 1 Parte convexe
1 Face plate - 1 Face convexe

Ø 20 mm - 160 g

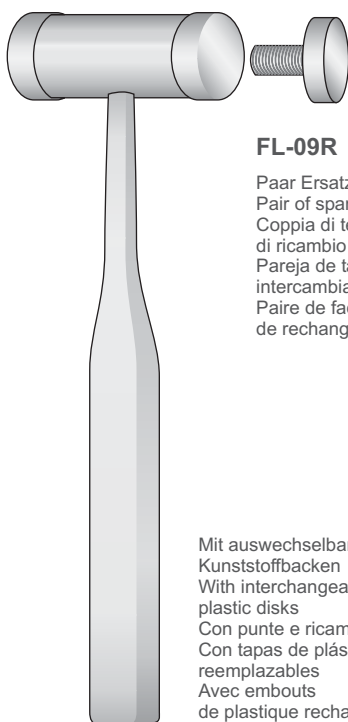

FL-09R

Paar Ersatzbacken
Pair of spare faces
Coppia di teste
di ricambio
Pareja de tapas
intercambiables
Paire de faces
de rechange

Mit auswechselbaren
Kunststoffbacken
With interchangeable
plastic disks
Con punte e ricambi in teflon
Con tapas de plástico
reemplazables
Avec embouts
de plastique rechangeables

**MEAD
FL-09**
190 mm

Ø 25 mm - 200 g

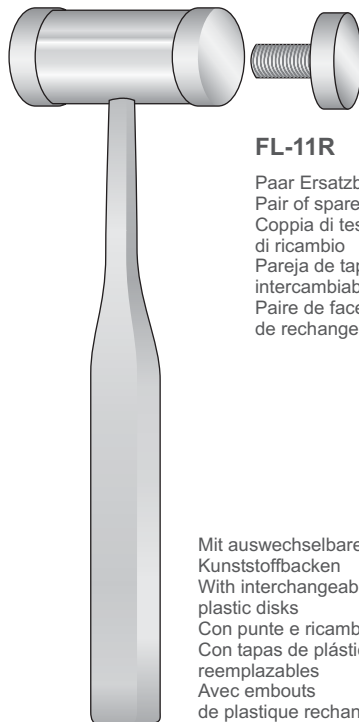

FL-11R

Paar Ersatzbacken
Pair of spare faces
Coppia di teste
di ricambio
Pareja de tapas
intercambiables
Paire de faces
de rechange

Mit auswechselbaren
Kunststoffbacken
With interchangeable
plastic disks
Con punte e ricambi in teflon
Con tapas de plástico
reemplazables
Avec embouts
de plastique rechangeables

**MEAD
FL-11**
200 mm

Ø 26 mm - 320 g

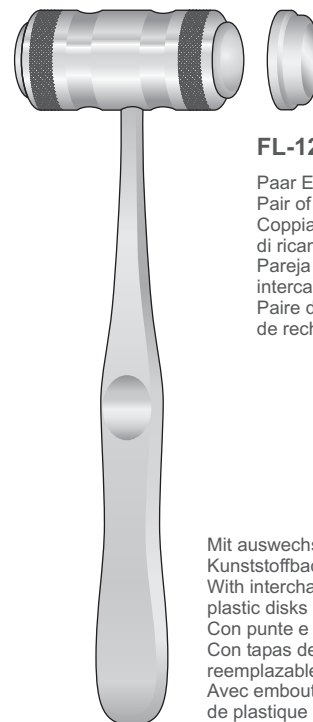

FL-12R

Paar Ersatzbacken
Pair of spare faces
Coppia di teste
di ricambio
Pareja de tapas
intercambiables
Paire de faces
de rechange

Mit auswechselbaren
Kunststoffbacken
With interchangeable
plastic disks
Con punte e ricambi in teflon
Con tapas de plástico
reemplazables
Avec embouts
de plastique rechangeables

**MEAD
FL-12**
190 mm



Sinus Lift Retraktoren - Sinus Lift Retractors
Divaricatori per Sinus Lift - Separadores para Sinus Lift
Écarteurs pour Sinus Lift

Raspatorien
Periosteals
Scollaperiosteal
Periostotomos
Raspatoires

17 mm

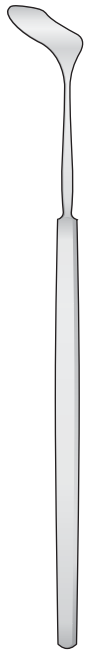

**SAUTTER
NK-249**
145 mm

11 mm

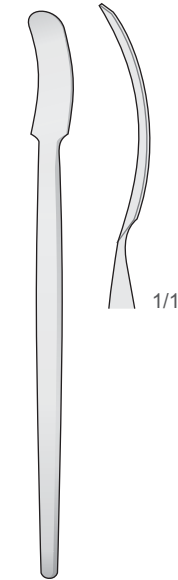

NK-105
125 mm

9 mm

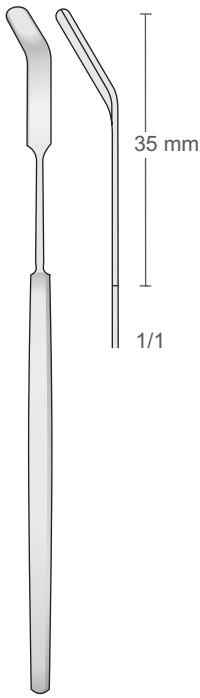

**MODELL GIESSEN
NK-251**
160 mm

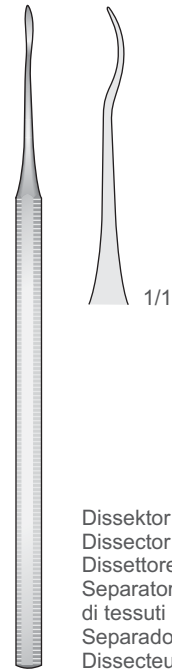

Dissektor
Dissector
Dissettore
Separatore
di tessuti
Separadores
Dissecteur

ES-13
135 mm

4,5 mm

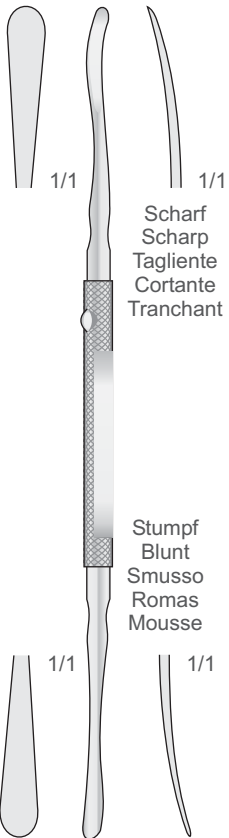

**FREER
FR-16**
180 mm

Scharf
Scharp
Tagliente
Cortante
Tranchant

Stumpf
Blunt
Smusso
Romas
Mousse

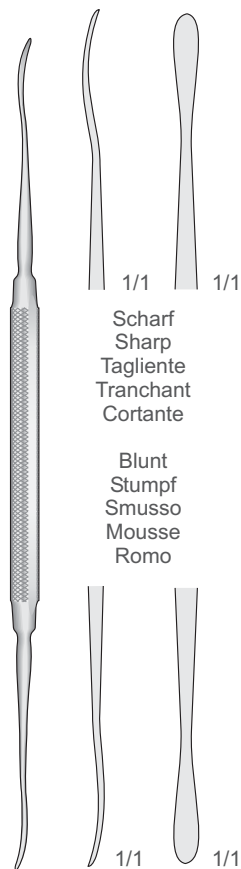

**FREER
FR-17**
185 mm

Scharf
Sharp
Tagliente
Tranchant
Cortante

Blunt
Stumpf
Smusso
Mousse
Romo

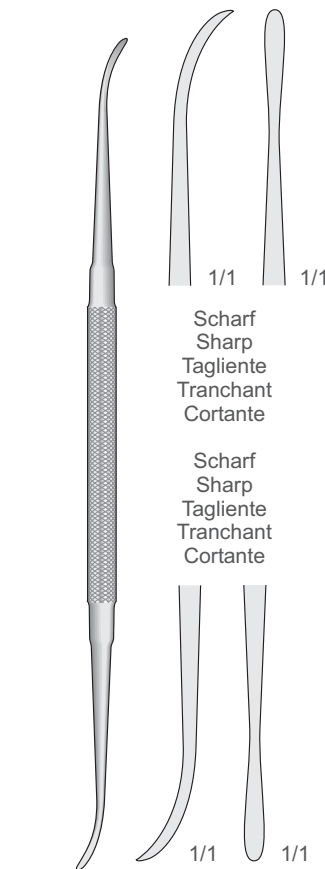

**FREER-YASARGIL
FR-17**
185 mm

Scharf
Sharp
Tagliente
Tranchant
Cortante

Scharf
Sharp
Tagliente
Tranchant
Cortante

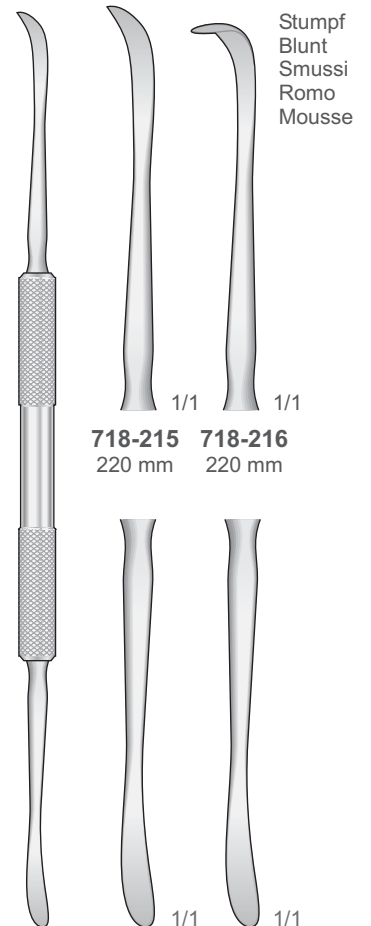

**OBWEGESER-FREER
718-215/718-216**
220 mm

718-215 718-216
220 mm 220 mm

Stumpf
Blunt
Smussi
Romo
Mousse



Knochen-Trephine
Bone Trephine
Trephine per osso
Trephine para huesos
Trephin pour os

Combination Trocar-Trephine Instruments

Bestehend aus einem Trokar, einer gezahnten Trephine und einem Kolben zur Entnahme von Knochentransplantaten aus Tibia und Beckenkamm mittels eines geschlossenen Verfahrens

Consisting of trocar, a toothed trephine and a plunger for taking tibial and iliac bone grafts through a closed technique

Composto di un trequarti, una camicia dentata ed un pistone per il prelievo degli innesti ossei dalla tibia e dalla cresta iliaca tramite una tecnica chirurgica intracutanea

Compuesto por un tròcar, un trépano dentado y un émbolo para obtener injertos óseos tibiales e iliacos mediante una técnica cerrada

Composé d'un trocart, d'une tréphine dentée et d'un piston pour le prélèvement de greffes osseuses de la tibia ou de la crête iliaque par une technique fermée

FK-100

Komplettset mit 4 Teilen
Set complete with 4 pieces
Set completo di 4 pezzi
Set completo con 4 piezas
Set complet avec 4 pièces

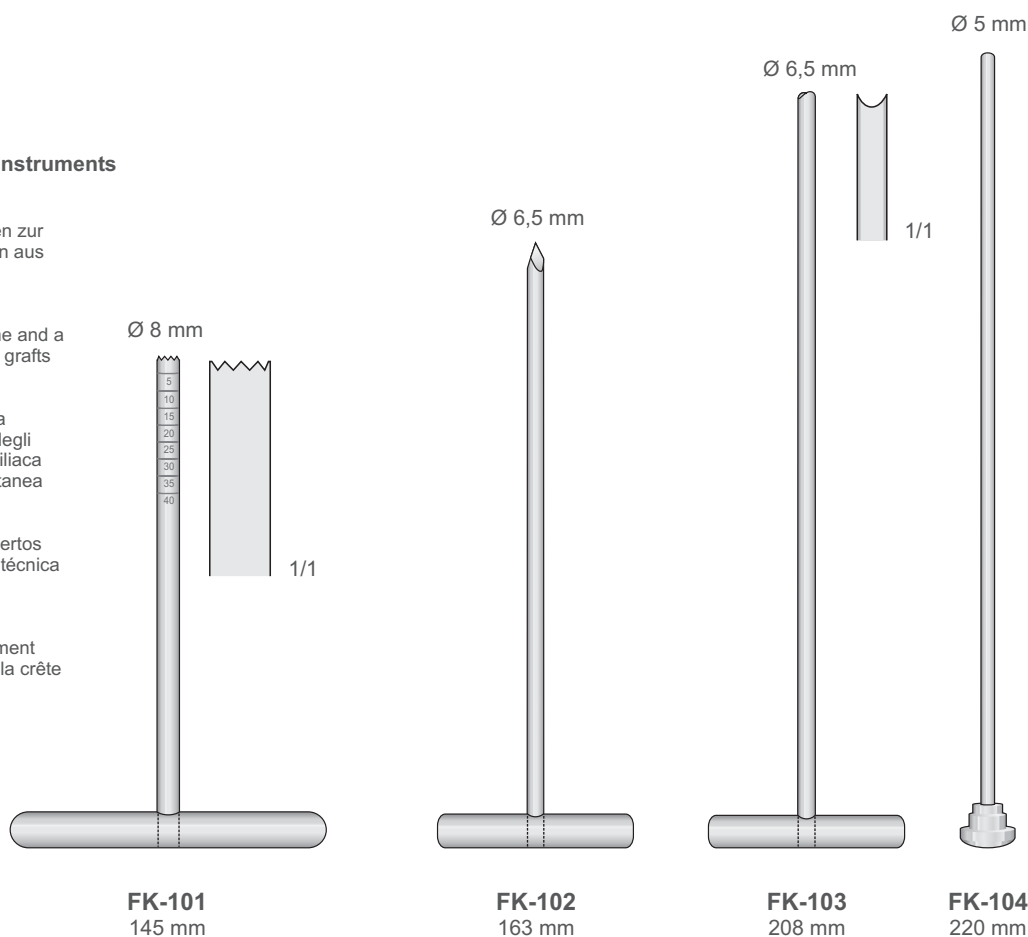

FK-105

Komplettset mit 4 Teilen
Set complete with 4 pieces
Set completo di 4 pezzi
Set completo con 4 piezas
Set complet avec 4 pièces

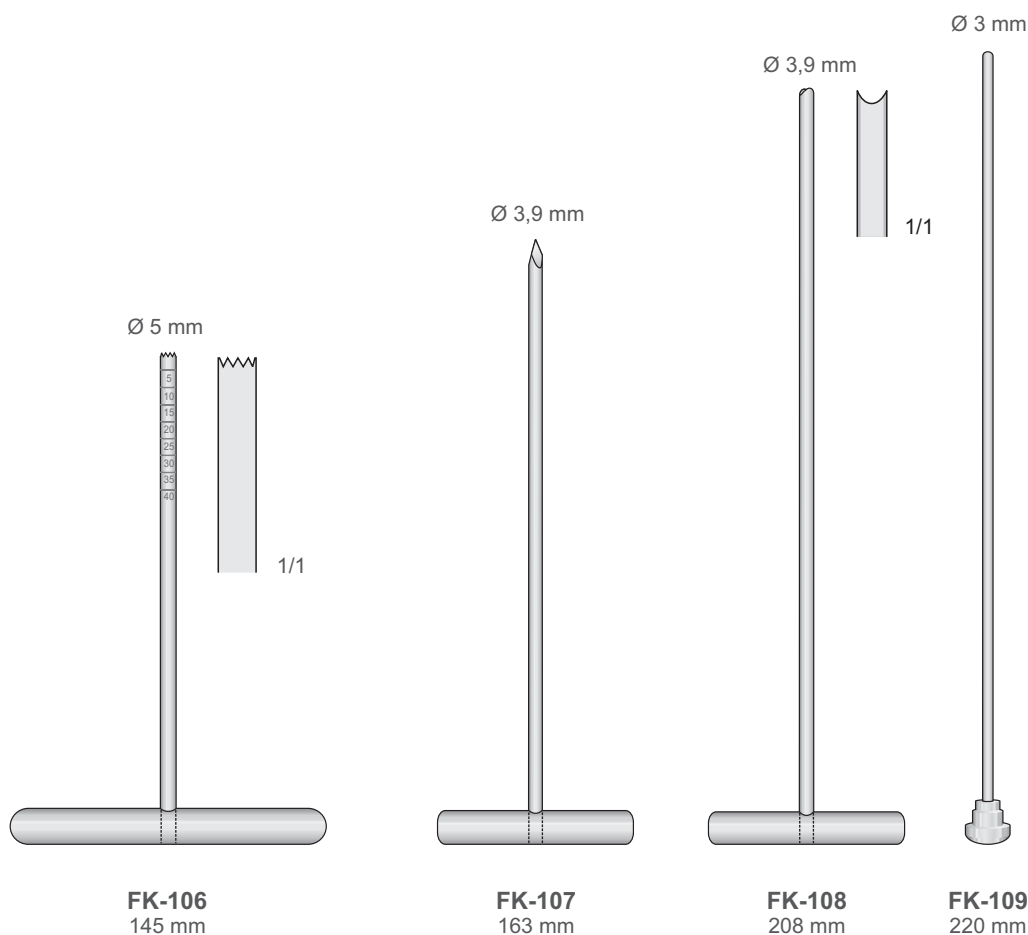



Osteotome
Osteotomes
Osteotomi
Osteótomos
Ostéotomes

Implant Sinus Lift Osteotomes

FL-400
Komplettsset mit
Set complete with
Set completo con
Kit completo con
Set complete avec
BS-60
FL-391/FL-399
(Fig.1 - 2 - 3 - 4 - 5 - 6 - 7 - 8 - 9)

Fig. 1
Ø 2.5 mm



FL-391
155 mm

Fig. 2
Ø 2.5 mm



FL-392
155 mm

Fig. 3
Ø 2.5 mm

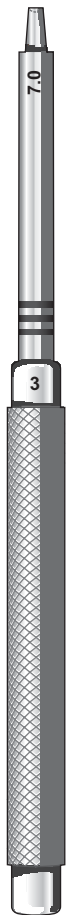

FL-393
155 mm

Fig. 4
Ø 2.5 mm



FL-394
155 mm

Fig. 5
Ø 2.5 mm



FL-395
155 mm



Osteotome
Osteotomes
Osteotomi
Osteòtomos
Ostéotomes

Implant Sinus Lift Osteotomes

FL-400M
Komplettsset mit
Set complete with
Set completo con
Kit completo con
Set complete avec

BS-60
FL-389/FL-399
(Fig.00 - 0 - 1 - 2 - 3 - 4 - 5 - 6 - 7 - 8 - 9)

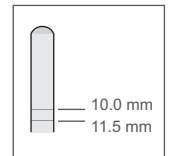
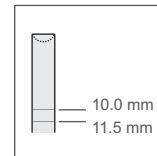

Fig. 6
Ø 2.5 mm



FL-396
155 mm

Fig. 7
Ø 2.5 mm



FL-397
155 mm

Fig. 8
Ø 2.5 mm



FL-398
155 mm

Fig. 9
Ø 3.1 mm



FL-399
155 mm

Fig. 00
Ø 3.0 mm



FL-389
155 mm

Fig. 0
Ø 3.0 mm



FL-390
155 mm



Fig. 1		Fig. 2		Fig. 3		Fig. 4		Fig. 5		Fig. 6	
Altezza	Diametro	Altezza	Diametro	Altezza	Diametro	Altezza	Diametro	Altezza	Diametro	Altezza	Diametro
0	Ø 1,60	0	Ø 1,90	0	Ø 2,80	0	Ø 3,10	0	Ø 3,90	0	Ø 5,50
7,5	Ø 1,80	7,5	Ø 2,20	7,5	Ø 3,20	7,5	Ø 3,70	10	Ø 5	10	Ø 6,20
10	Ø 2	10	Ø 2,35	10,5	Ø 3,35	10,5	Ø 3,90	13	Ø 5,20	13	Ø 6,30
13,5	Ø 2,40	13,5	Ø 3,30	13,5	Ø 3,60	15,5	Ø 4,30	20,5	Ø 6,30		
15,5	Ø 3,60	15,5	Ø 3,40	21	Ø 4,40						
		23,5	Ø 4,50								

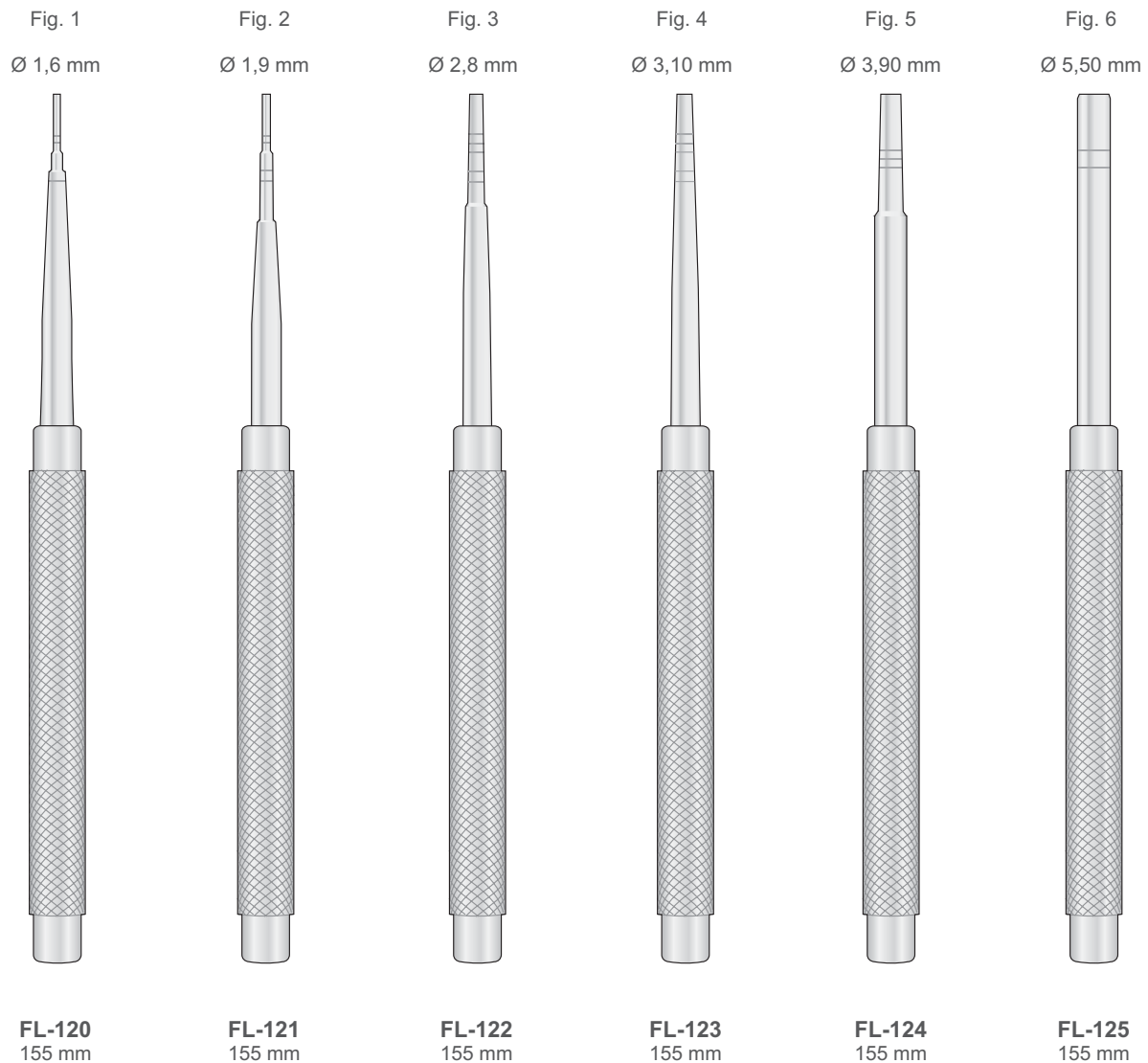



Osteotome
Osteotomes
Osteotomi
Osteotomos
Ostéotomes

L.	Ø 1° osteotomo	Ø 2° osteotomo	Ø 3° osteotomo	Ø 4° osteotomo	Ø 5° osteotomo
0	1,5	2,1	2,6	3,0	3,5
5	1,9	2,6	3,0	3,5	3,9
8	2,2	2,8	3,3	3,8	4,2
10	2,4	3,0	3,5	4,0	4,4
12	2,6	3,2	3,7	4,2	4,6
14	2,8	3,4	3,9	4,4	4,8

Retificator
Rettificatori

Fig. 1
Ø 1,5 mm



FL-292
155 mm

Fig. 2
Ø 2,1 mm



FL-293
155 mm

Fig. 3
Ø 2,6 mm



FL-294
155 mm

Fig. 4
Ø 3,0 mm



FL-295
155 mm

Fig. 5
Ø 3,5 mm



FL-296
155 mm

Ø 2,8 mm



FL-297
155 mm

Ø 3,5 mm



FL-298
155 mm

Ø 4,2 mm



FL-299
155 mm



Osteotome
Osteotomes
Osteotomi
Osteótomos
Ostéotomes

Knochenmeißel Graduiert
Graduated Chisels
Scalpelli graduati
Osteótomos graduado
Ostéotomes gradués

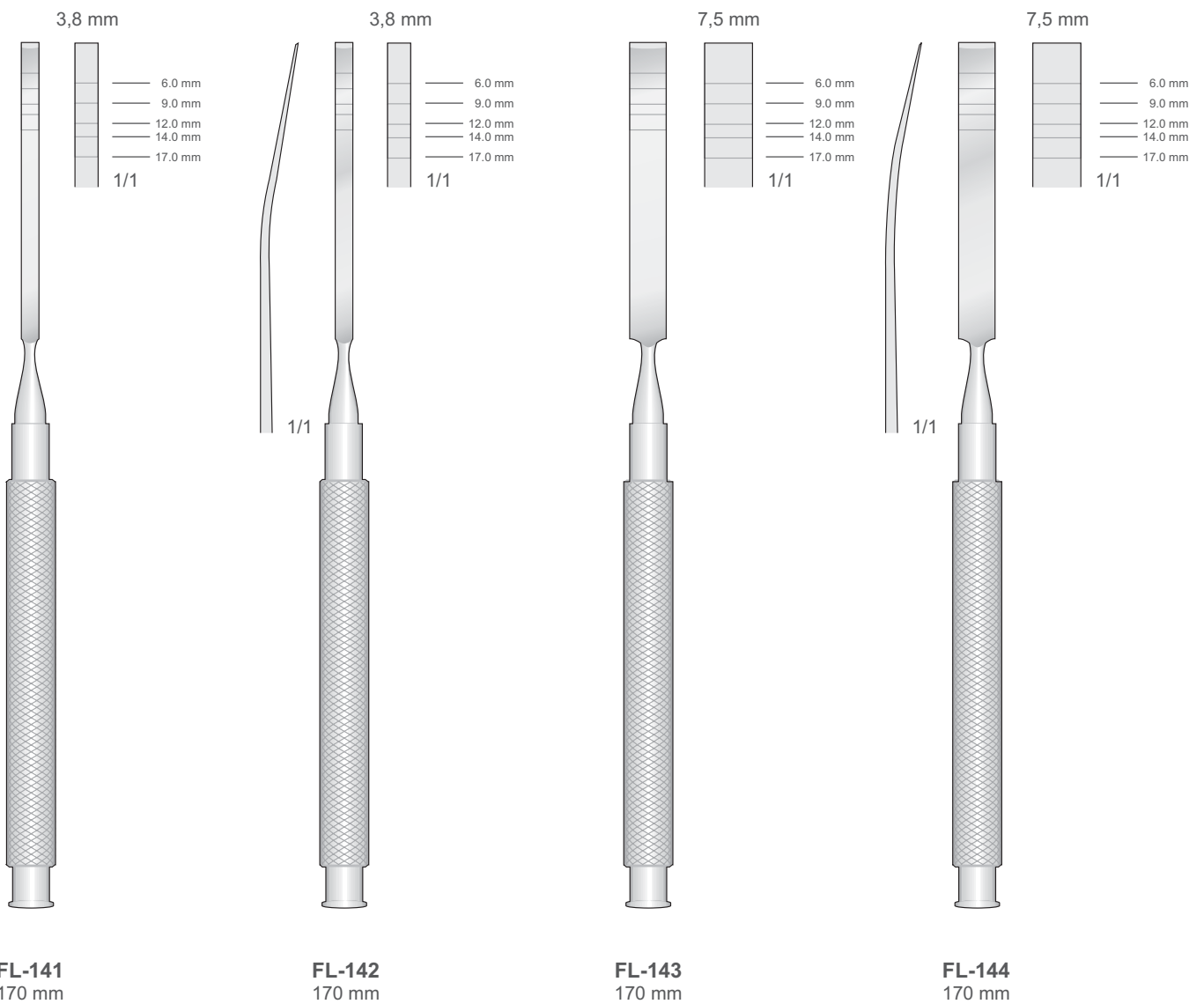



Osteotome
Osteotomes
Osteotomi
Osteótomos
Ostéotomes

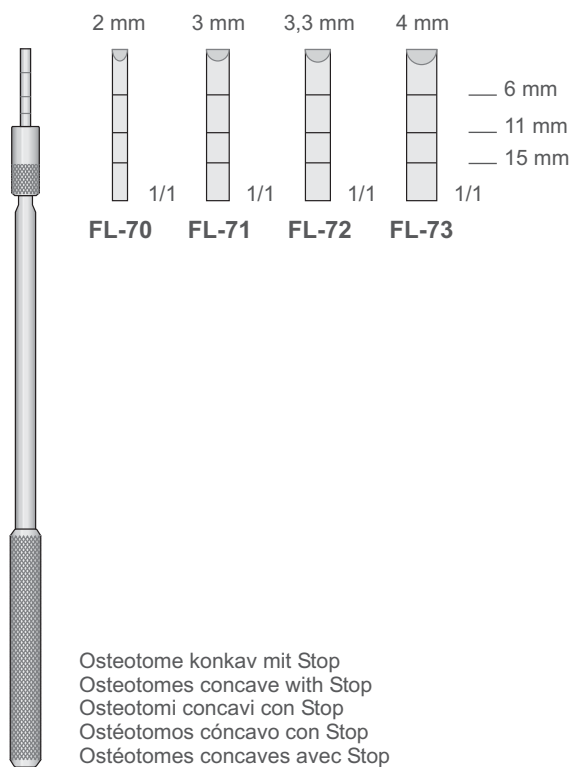

FL-70/FL-73
165 mm

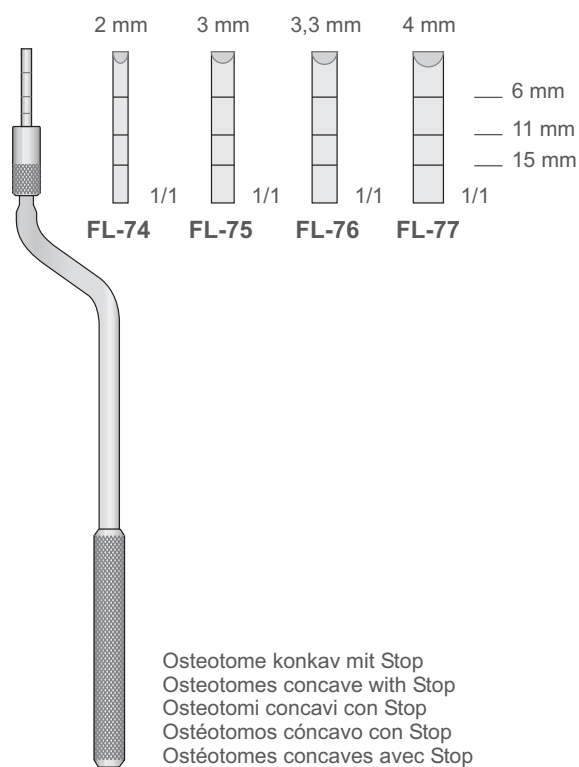

FL-74/FL-77
165 mm

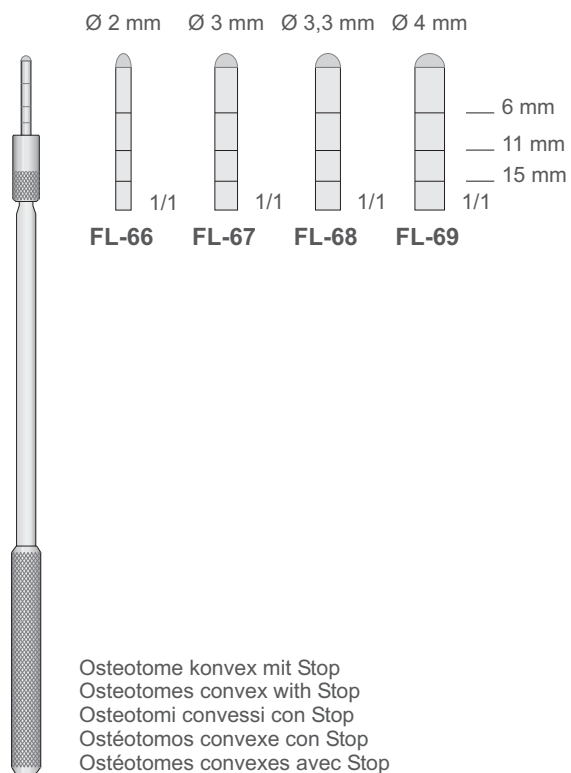

FL-66/FL-69
165 mm

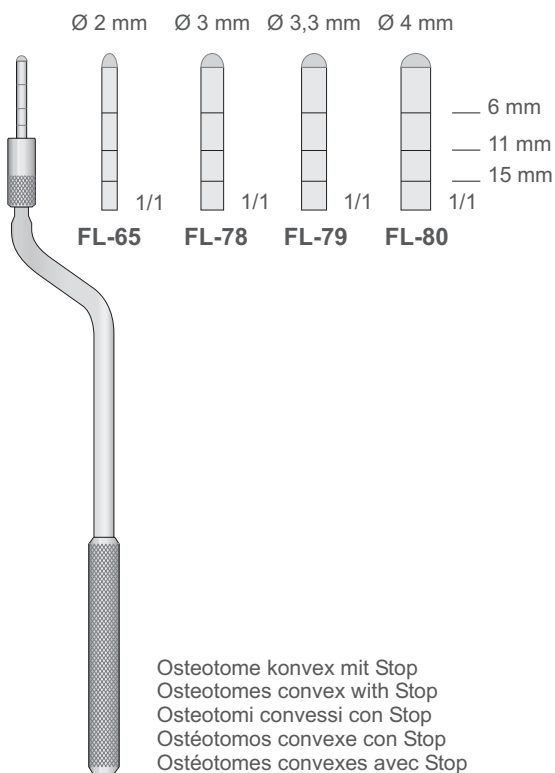

FL-65/FL-80
160 mm



Osteotome
Osteotomes
Osteotomi
Osteótomos
Ostéotomes

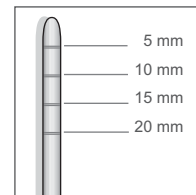
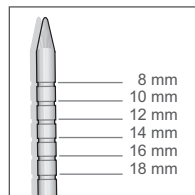

Implant Site Dilator
Implant Site Dilators
Dilatatori per osso
Dilatadores oséos
Dilatateur d'os

Expansion Osteotome
Expansion Osteotomes
Espansori di osso
Expansores oséos
ExpansEURS d'os

Ø 2 mm

Ø 3 mm

Ø 3,3 mm

Ø 4 mm

Ø 3 mm

Ø 4 mm

Ø 5 mm

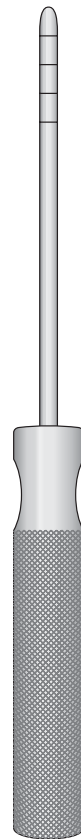

FL-25
145 mm

FL-26
145 mm

FL-27
145 mm

FL-28
145 mm

FL-37
145 mm

FL-38
145 mm

FL-39
145 mm



Trephine
Trephine Burs
Frese carotatrici - Trephine
Trephine
Trephine

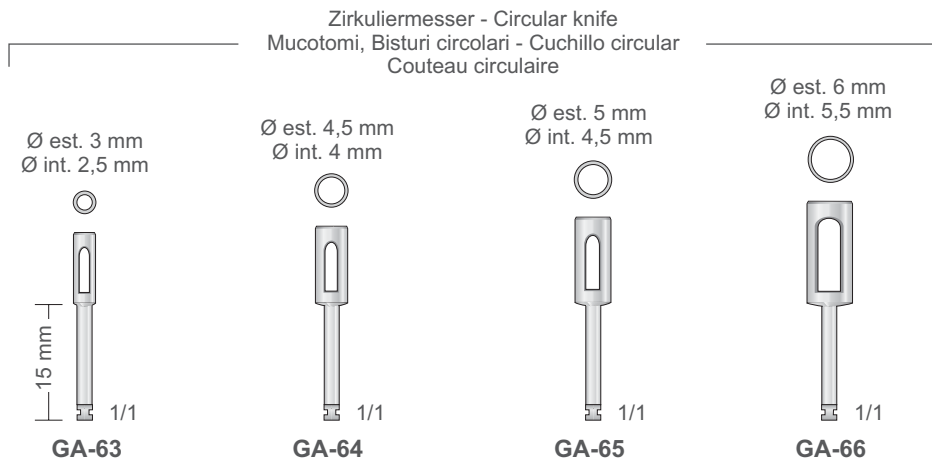
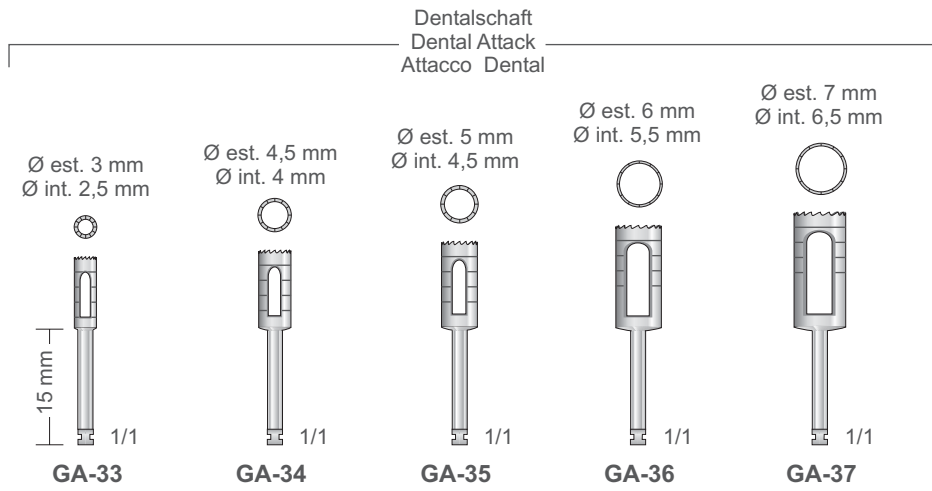

Hautstanzen - Tissue punches
Mucotomi Punches - PUNCHES para cortar tejidos
Punches à couper le tissu

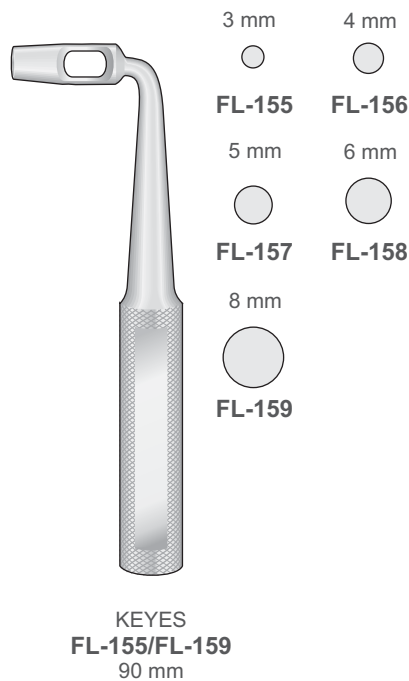
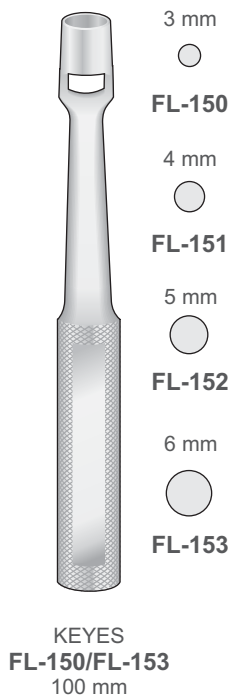

Implant Graduierung
Implant depth gauge with ball end
Sonda per controllare la profondità del sito
Sonda para controlar la profundidad

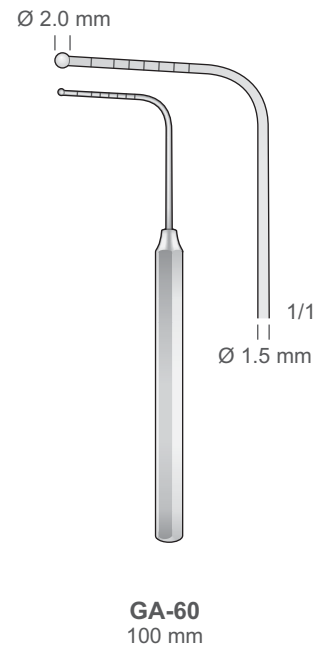



Implantologie Instrumente
 Implantology Instruments
 Strumenti per implantologia
 Instrumentos para Implantología
 Instruments pour Implantologie

Knochenschale
 Bone Well
 Bacinella per osso
 Cubeta para hueso
 Cuvette à os



Rostfrei
 Stainless Steel
 Acciaio inossidabile
 Acero inoxidable
 Acier Inoxydable

SS-65
 35 mm

Absaugkanülen für Knochen, mit 1 Filter
 Suction tube for bone, with 1 filter
 Cannule d'aspirazione con trattenuta osso, con 1 filtro
 Cánulas aspiradoras para hueso, con 1 filtro
 Canule à aspiration d'os avec 1 filtre

Membranplatzierungsinstrumente
 Membrane Placement Instruments
 Strumenti per posizionare membrana
 Instrumentos para colocar membranas
 Instruments d'application de membrane

Aufbring Instrument
 für Knochenmaterial
 Applicator for bone material
 Appllicatore per materiale osseo
 Cucharillas para huesos
 Currettes à os

Ersatzknochenfilter
 Bone Filter of replacement
 Filtro di ricambio per osso
 Filtro de repuesto para hueso
 Filtre de rechange pour os

Rostfrei
 Stainless Steel
 Acciaio inossidabile
 Acero inoxidable
 Acier Inoxydable

Ø 10 mm int.

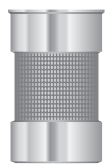

1/1

GF-134
 20 mm

Sterilisierbar
 Autoclavable
 Autoclavabile

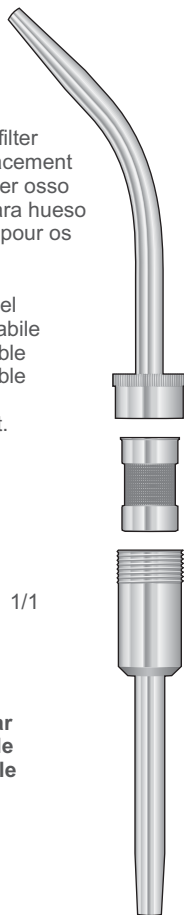

GF-133
 180 mm

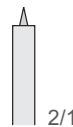

2/1



MPI-1
 185 mm



1/1

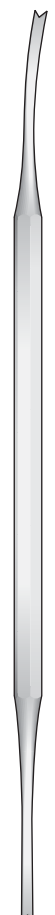

LUNIATSCHEK
PF-6
 170 mm

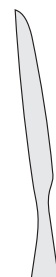

1/1



IM-15
 180 mm



1/1



Knochenspritzen
Bone Syringes
Siringhe per osso
Jeringas de hueso
Seringues à os

Einbringinstrument für Knochenmaterial
Graft materials Syringes
Inserters for Bone material
Siringhe per biomateriali

Ø Int. 2,5 mm
Ø Est. 3,5 mm

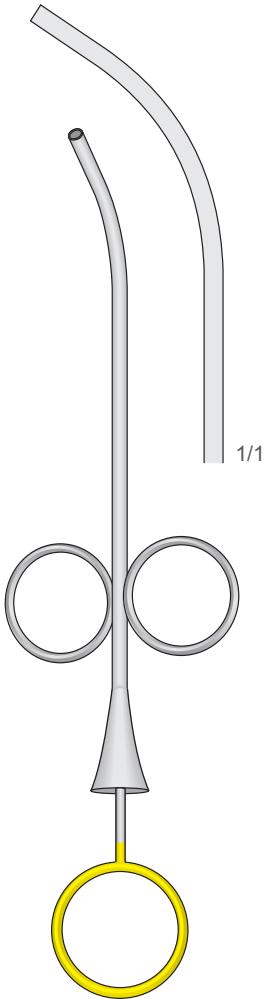

SS-60M
160 mm

Ø Int. 3,5 mm
Ø Est. 4,5 mm

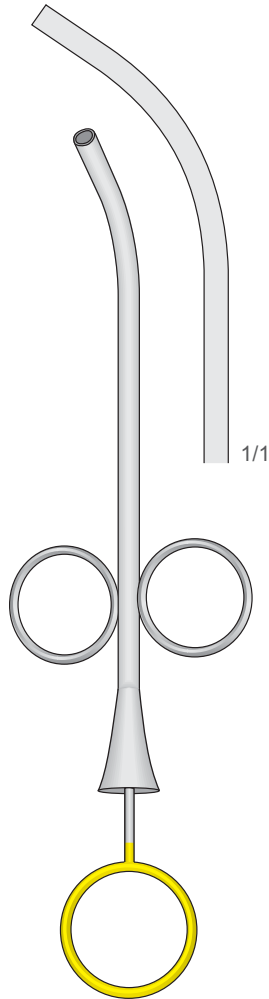

SS-61M
160 mm

Ø Int. 4,4 mm
Ø Est. 5,5 mm

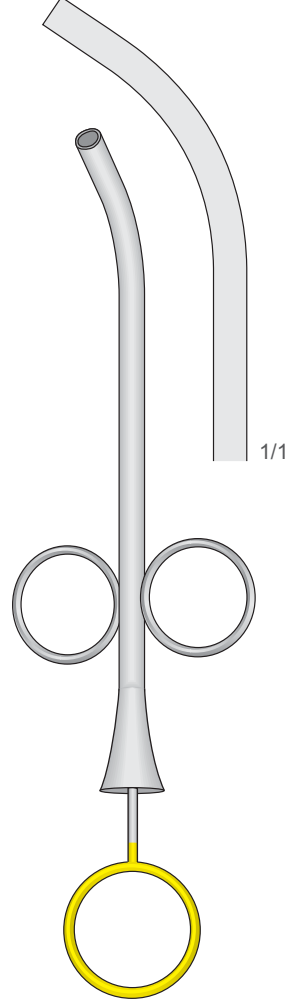

SS-62M
160 mm

Ø Int. 6 mm
Ø Est. 7 mm

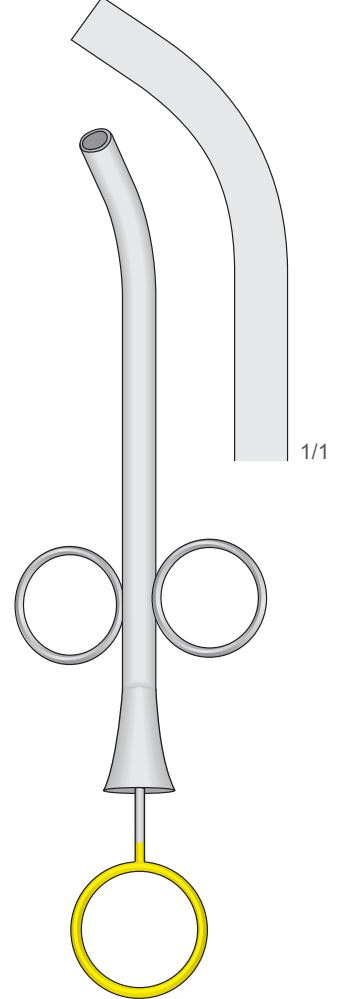

SS-64M
160 mm



Knochenstopfer
 Bone tampers - Bone packers
 Compattatore per osso
 Compactador para huesos
 Compacteur à os - Pilons

Knochenschaber, Rostfrei Stahl - Bone scraper, Stainless Steel
 Grattini per osso, Inox - Raspador de hueso, Acero inoxidable
 Râpes à os, Acier inoxydable

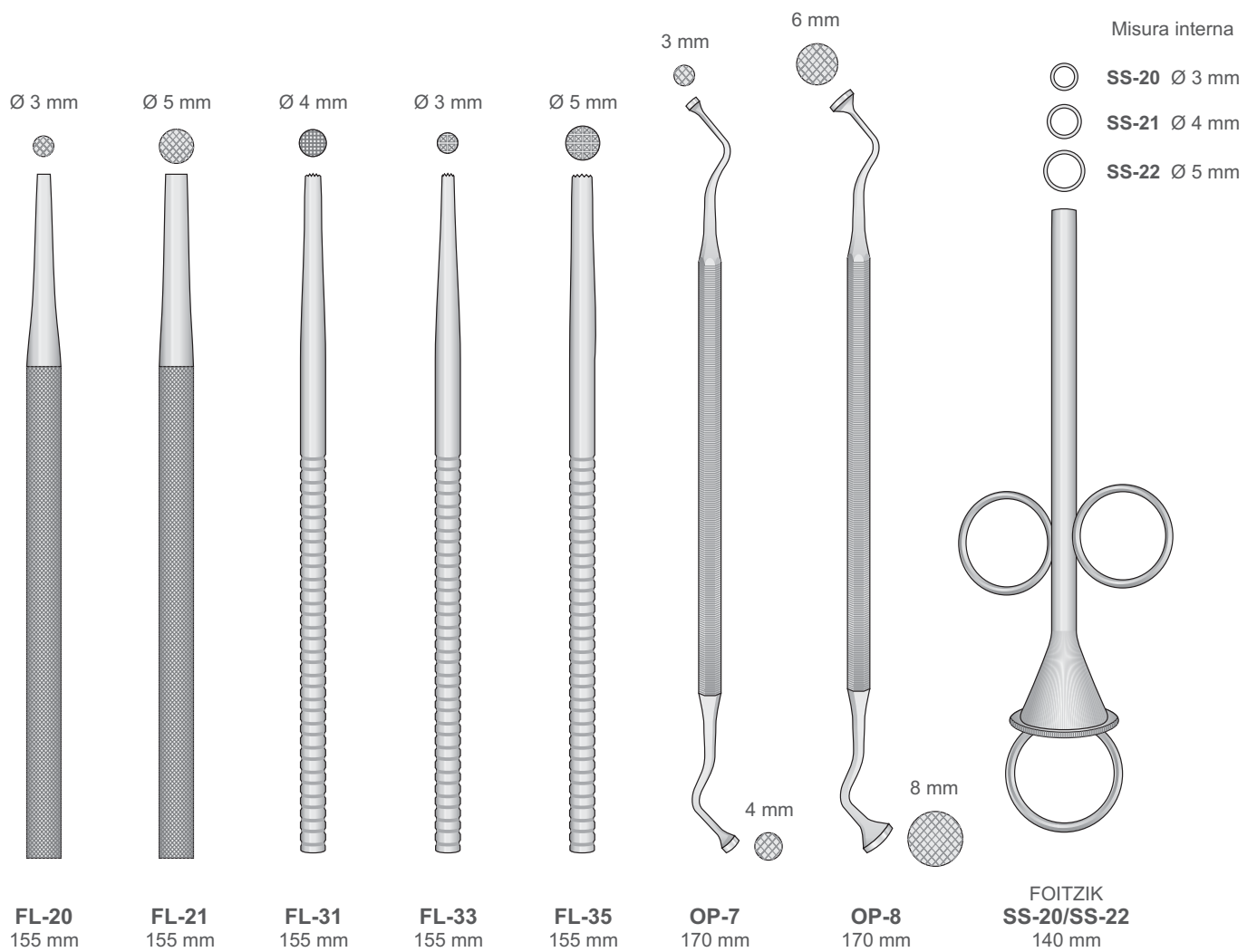
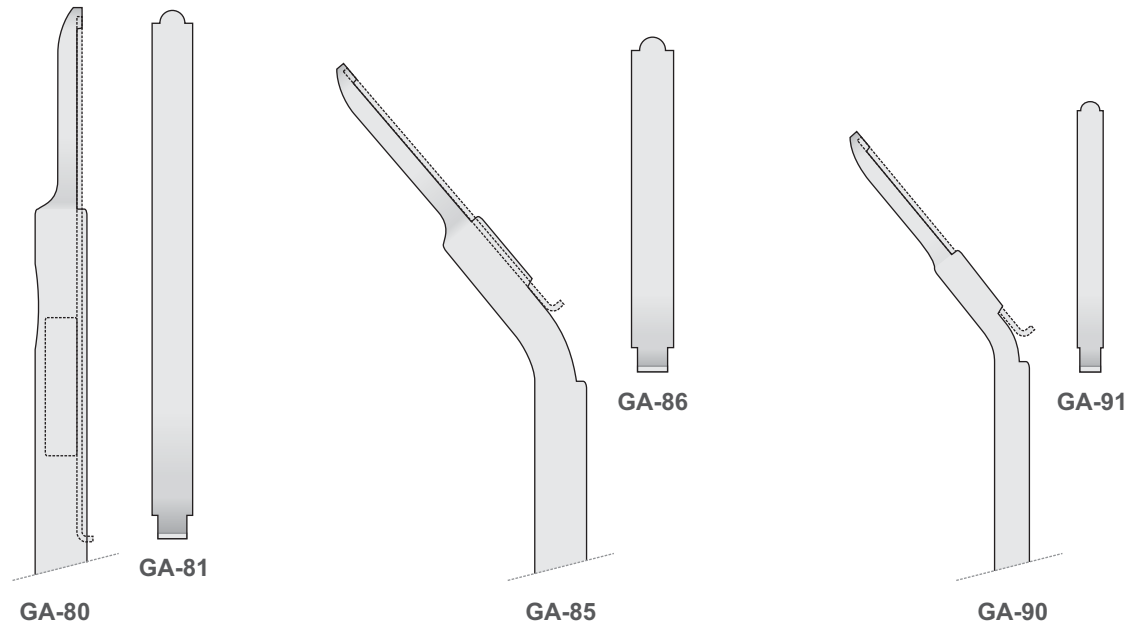



Knochenschaber, Rostfrei Stahl
Bone scraper, Stainless Steel
Grattini per osso, Inox
Raspador de hueso, Acero inoxidable
Ràpes à os, Acier inoxydable

Knochenreibeschlinge
Blade of change
Lama di ricambio
Hojas de recambio
Lâme de rechange

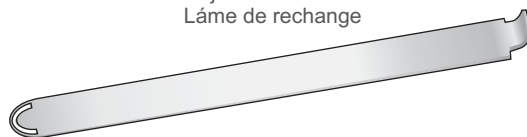

GA-71
90 mm

Knochen-Schaben Komplett
mit Reibeschlinge
Bone-Grafts complete with blade
Grattino completo di lama

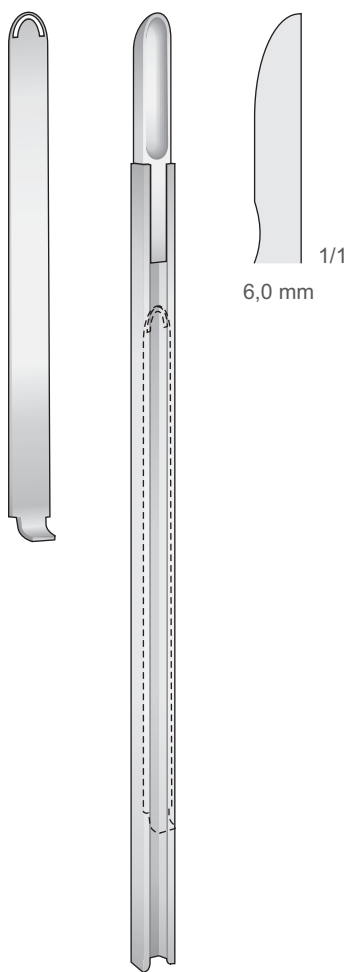

GA-70
170 mm

Knochen-Schaben Komplett
mit Reibeschlinge
Bone-Grafts complete with blade
Grattino completo di lama

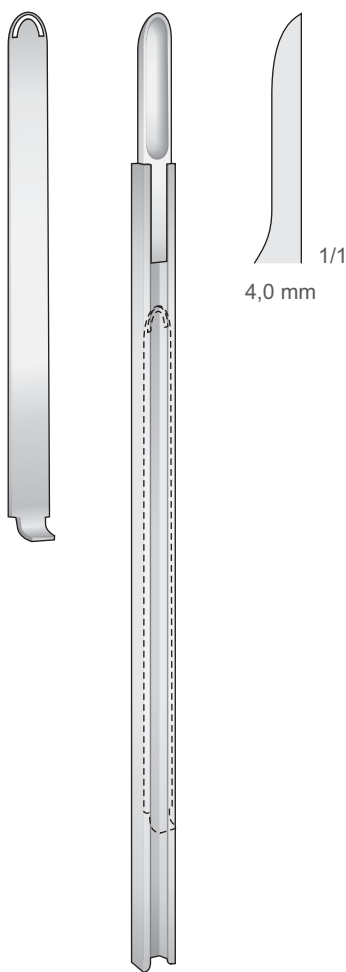

GA-73
170 mm

Knochen-Schaben Komplett
mit Reibeschlinge
Bone-Grafts complete with blade
Grattino completo di lama

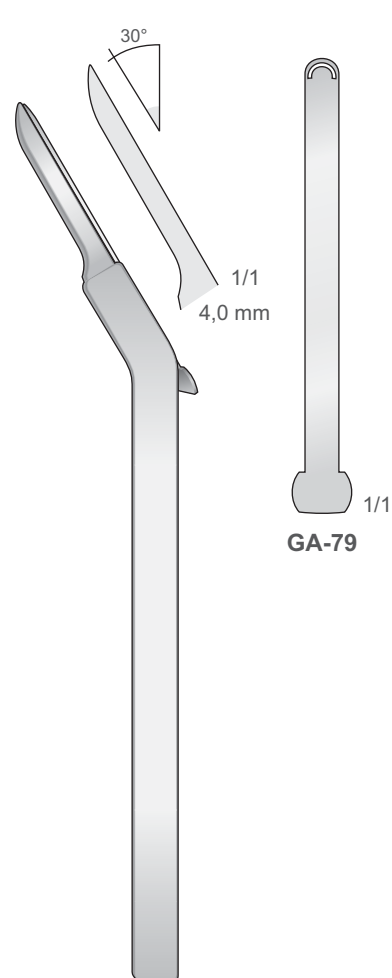

GA-78
155 mm

GA-79
1/1



Messinstrumente
Measuring instruments
Strumenti per misura
Instrumentos para medir
Instruments à mesurer

Meßbereich: 0 - 20 mm
Measuring range: 0 - 20 mm
Campo di misura: 0 - 20 mm
Alcance de medición: 0 - 20 mm
Etendue de mesure: 0 - 20 mm

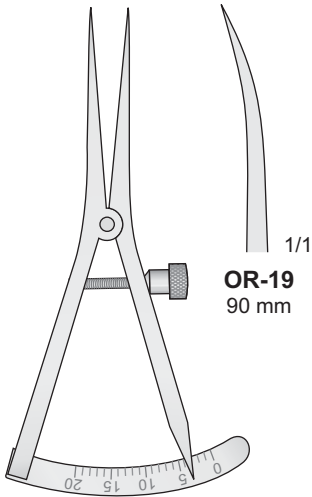

CASTROVIEJO
OR-19
90 mm

0,5 mm



LS-08
100 mm

0,5 mm



LS-09
200 mm

Meßbereich: 0 - 80 mm
Measuring range: 0 - 80 mm
Campo di misura: 0 - 80 mm
Alcance de medición: 0 - 80 mm
Etendue de mesure: 0 - 80 mm



OR-40
125 mm

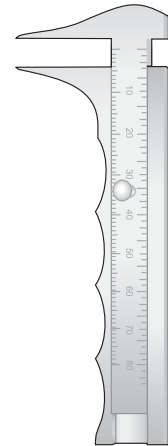

OR-45
95 mm

Meßbereich: 0 - 40 mm
Measuring range: 0 - 40 mm
Campo di misura: 0 - 40 mm
Alcance de medición: 0 - 40 mm
Etendue de mesure: 0 - 40 mm

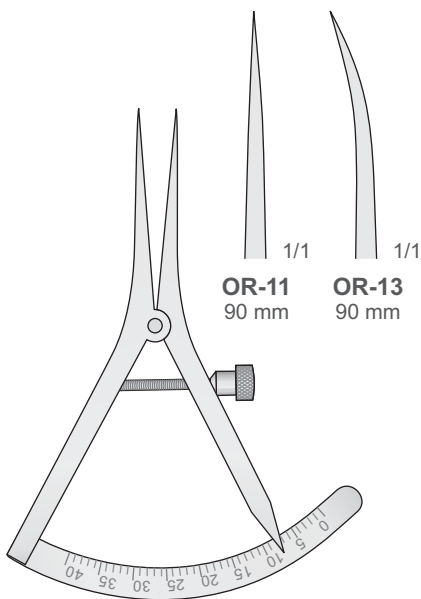

CASTROVIEJO
OR-11/OR-13
90 mm

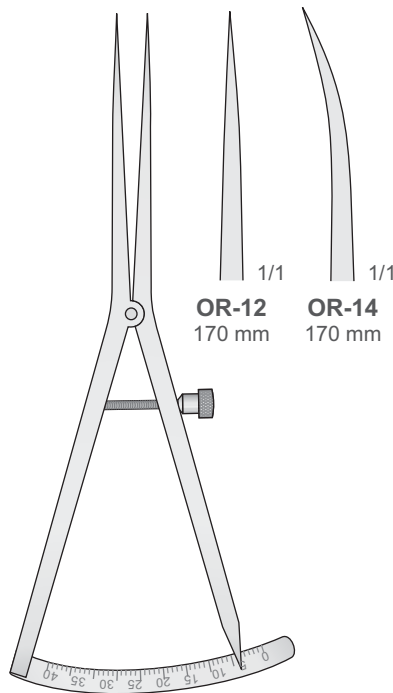

CASTROVIEJO
OR-12/OR-14
170 mm

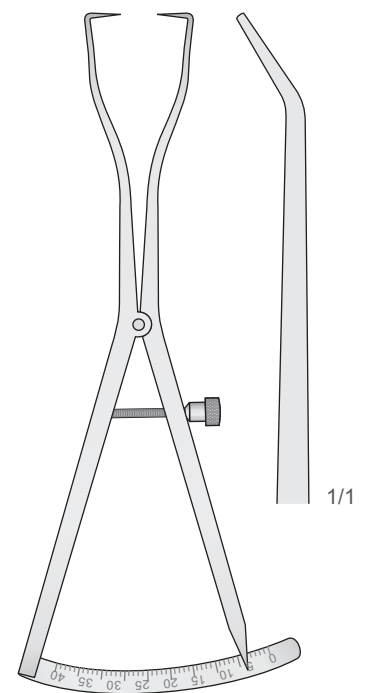

CASTROVIEJO
OR-18
170 mm

Osteometer
Osteometer
Osteometro
Osteometro
Osteometer

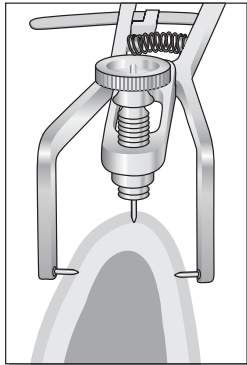

DB-300

Implantat - Messzange
Implantology Caliper
Misuratore per Implantologia
Calibre de implantologia
Compas d'implantologie

Trei-Dimensional
Tridimensionally
Misuratore tridimensionale
per misurazione cresta

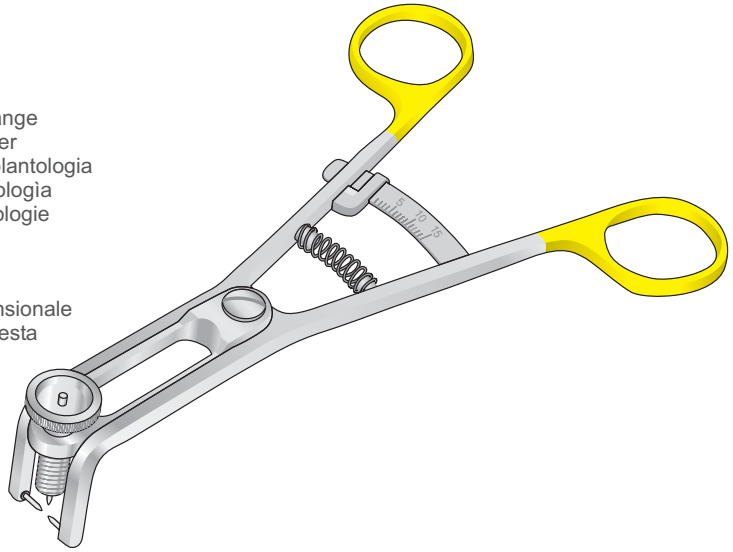

BONE BLOCK CLAMP

Bohrzangen für Knochen-Transplantate
Bone graft holding and drilling forceps
Pinza di fissaggio Graft
Pinzas para coger y taladrar óseo

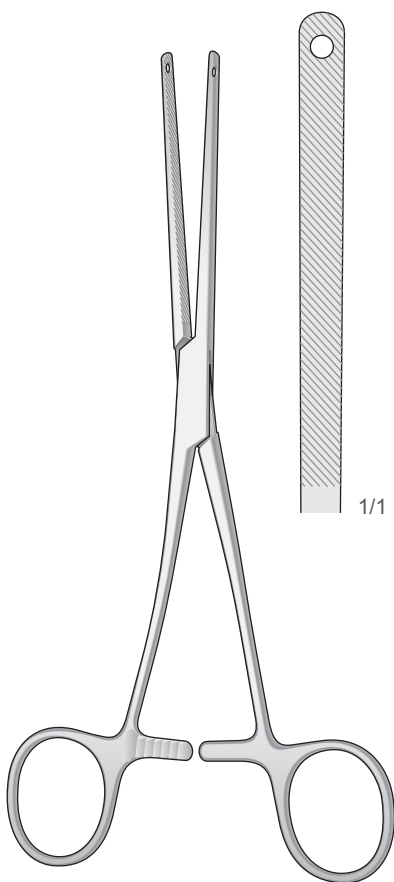

P-340
220 mm

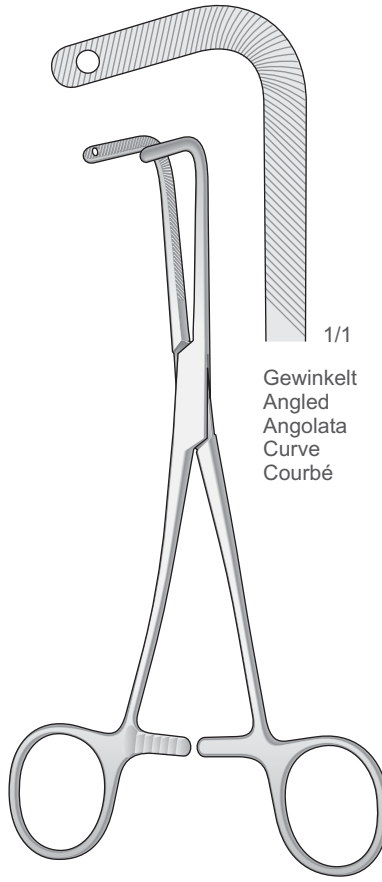

P-341
200 mm

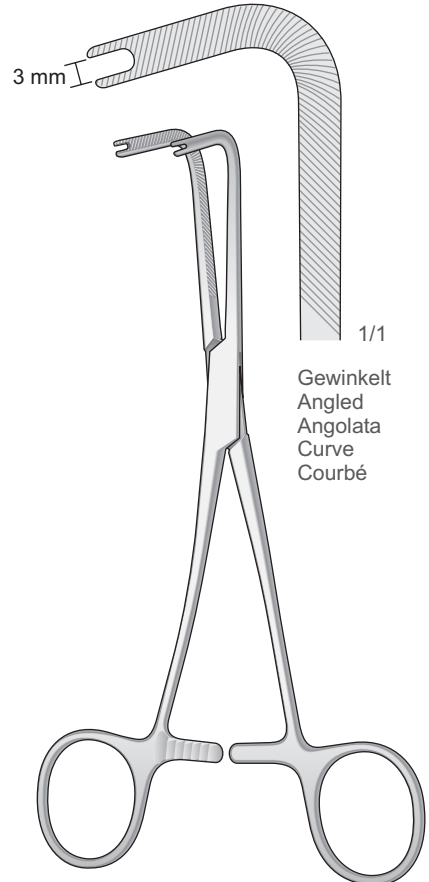

P-342
200 mm



Wundspreizer - Knochenhaltezange
 Retractor - Bone holding Forceps
 Divaricatore - Pinza per fissare l'osso
 Separador - Pinzas para coger huesos
 Ecarteur - Pincés pour tenir l'os

Tibia Wundspreizer
 Tibial and Iliac Retractor
 Divaricatore per tibia e cresta iliaca
 Separadores para tibiales y iliacos
 Ecarteur pour tibia e crête iliaque

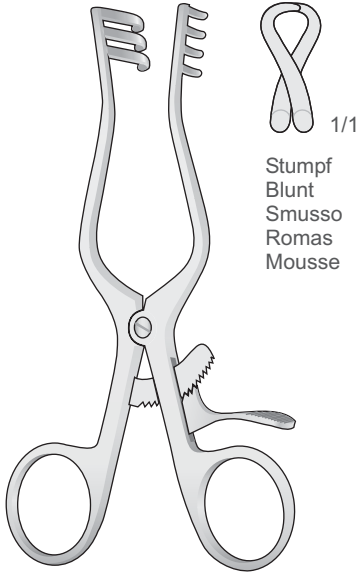

WEITLANER
BV-23
 165 mm

1/1
 Stumpf
 Blunt
 Smusso
 Romas
 Mousse

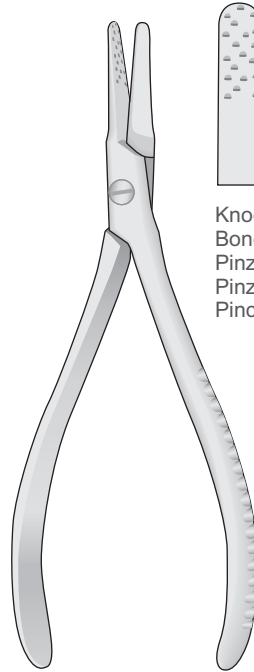

RADOLF
FO-159
 135 mm

1/1 1/1
 Knochenhaltezange
 Bone holding forceps
 Pinza per fissare l'osso
 Pinzas para coger huesos
 Pincés pour tenir l'os

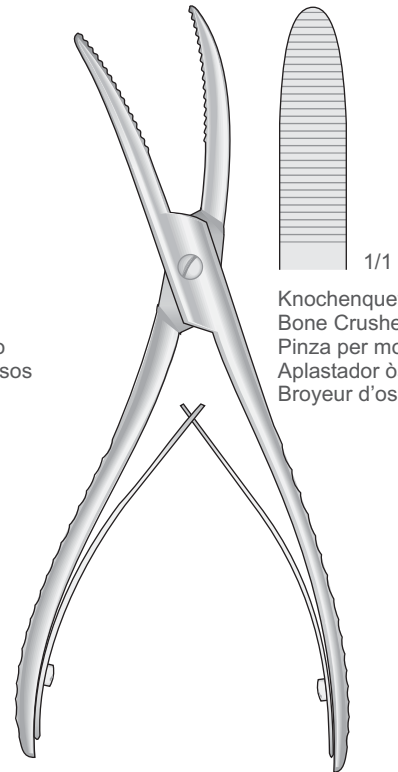

WOLFF
LX-113
 180 mm

1/1
 Knochenquetsche
 Bone Crusher
 Pinza per modellare l'osso
 Aplastador óseo
 Broyeur d'os

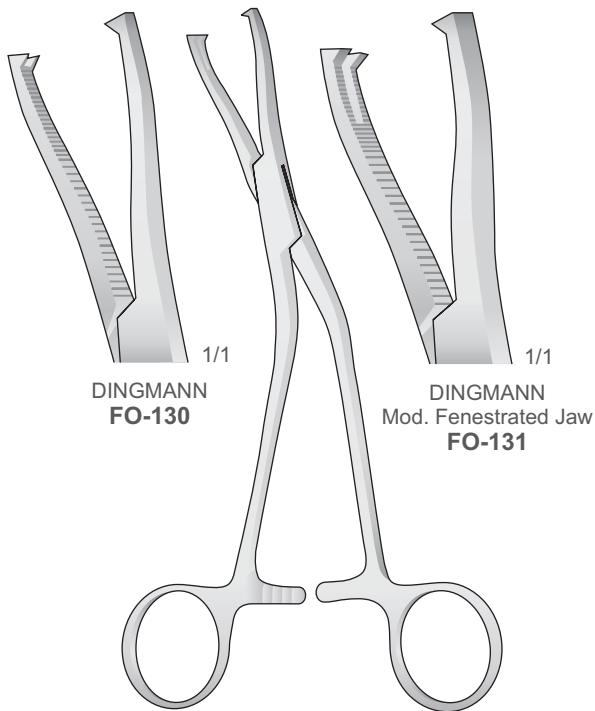

DINGMANN
FO-130

DINGMANN
 Mod. Fenestrated Jaw
FO-131

DINGMANN
FO-130/FO-131
 190 mm

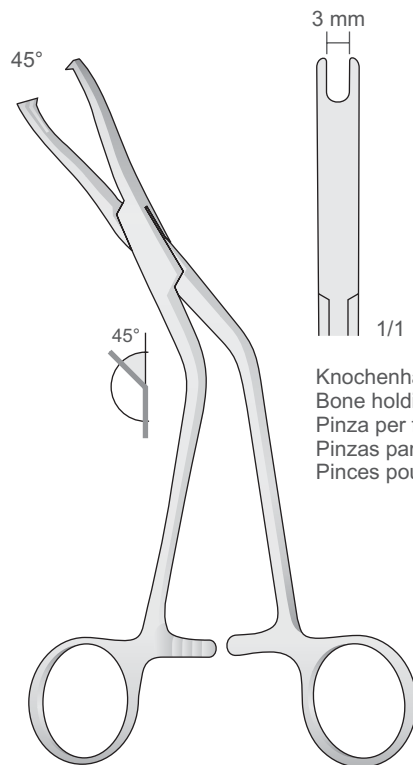

DINGMANN - Mod. Fenestrated Jaw
FO-131S
 190 mm

3 mm
 1/1
 Knochenhaltezange
 Bone holding forceps
 Pinza per fissare l'osso
 Pinzas para coger huesos
 Pincés pour tenir l'os

.10

Raspatorien, Löffel, Hohlmeißelzangen
Raspatories, Curettes, Bone rongeurs
Scollaperiostei, Cucchiali, Pinze ossivore
Rugines, Cucharillas, Pinzas-gubias
Legras, Curettes, Ponces-gouges

Zahnärztliche Chirurgie
Dental surgery
Chirurgia dentale
Cirugia dental
Chirurgie dentaire





Periosteal elevators

Scharf - Sharp
Taglienti - Cortante
Tranchant

Raspatorien
Periosteal Raspatories
Periostotomi
Legras periostotomos
Rugines à périostomie

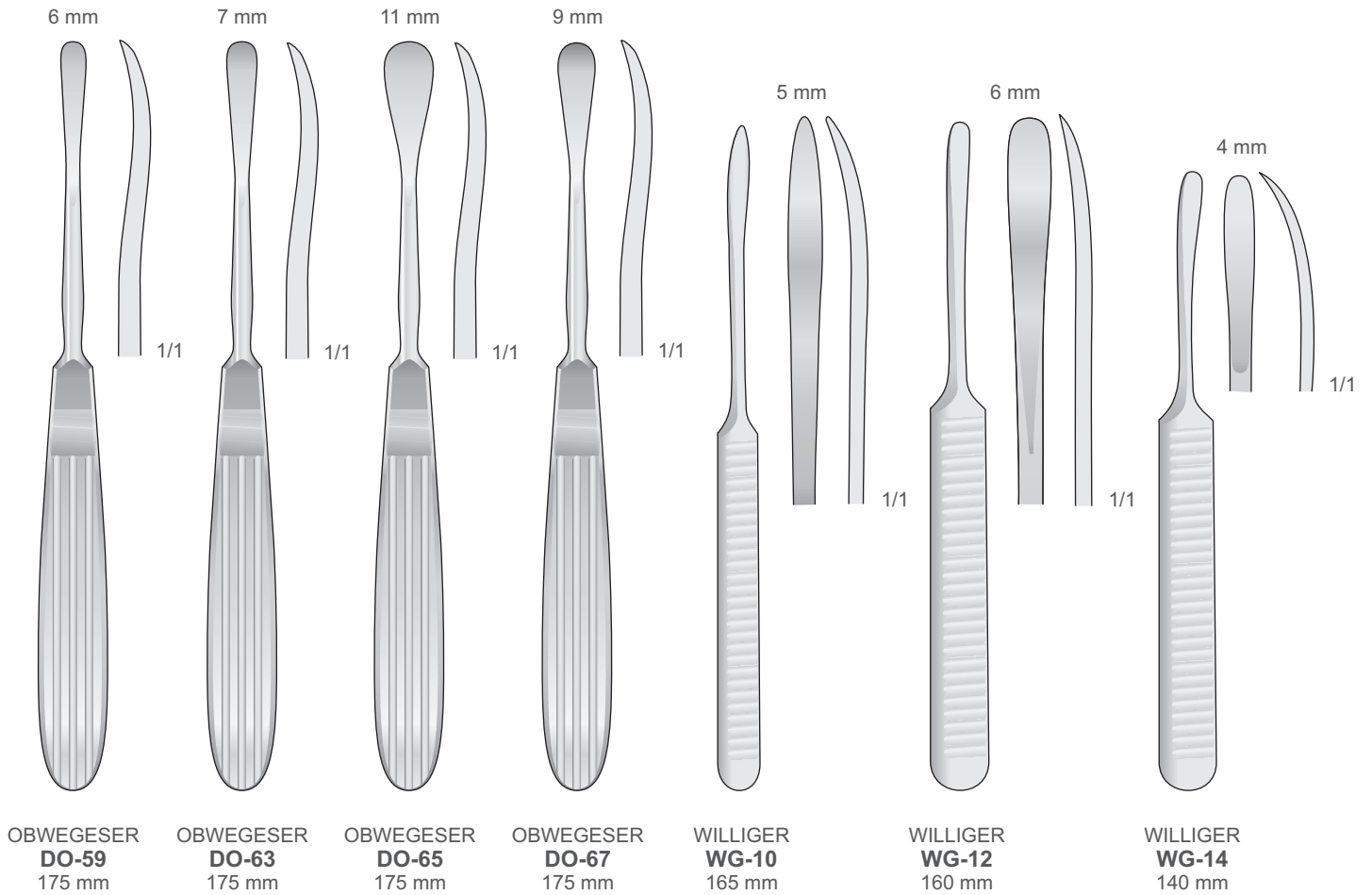



Raspatorien
Raspatories
Periostotomi
Legras
Rugines

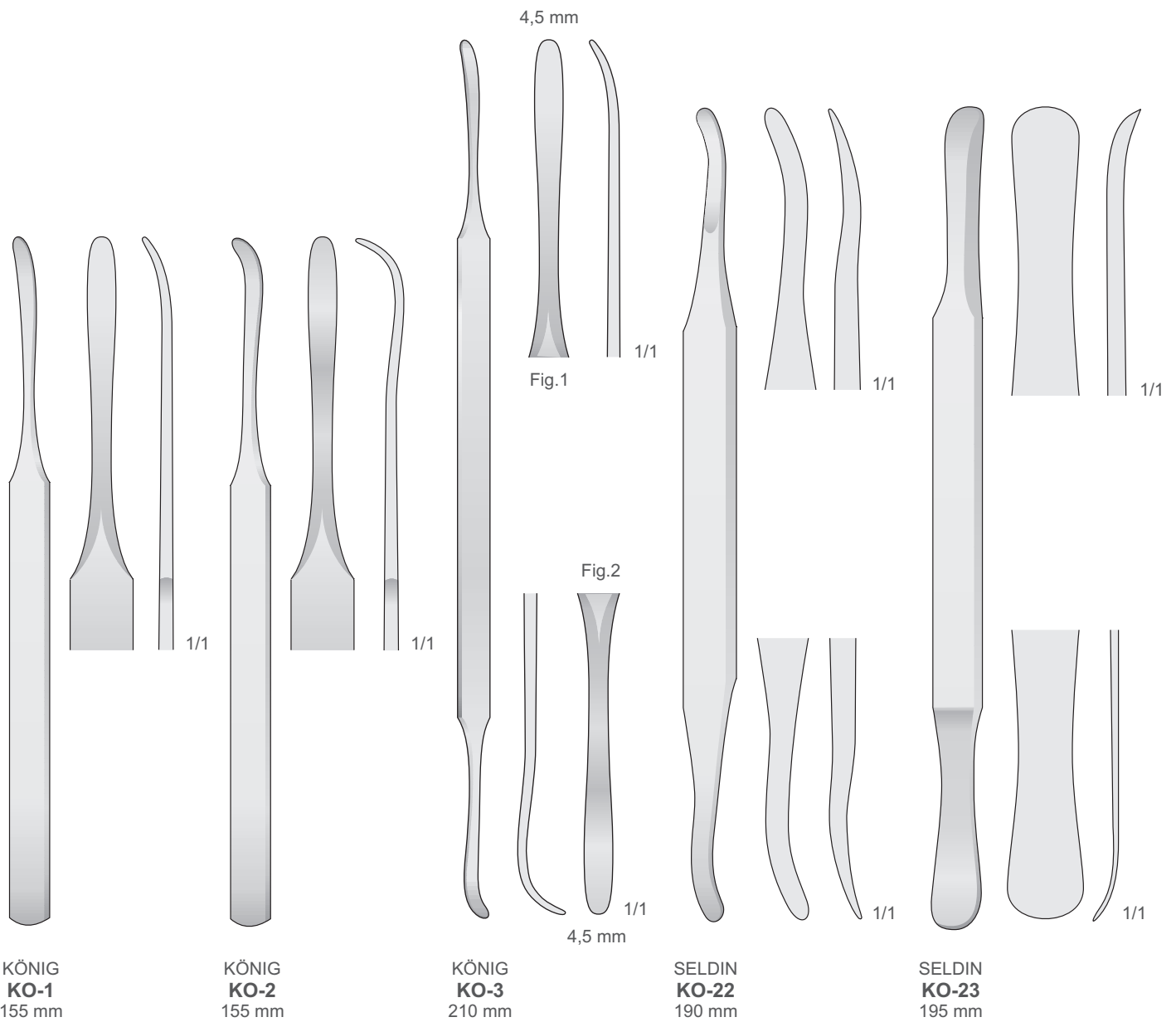

Raspatorien - Elevatorien
Raspatories - Elevators
Periostotomi - Elevatori
Legras - Elevadores
Rugines - Elevateurs

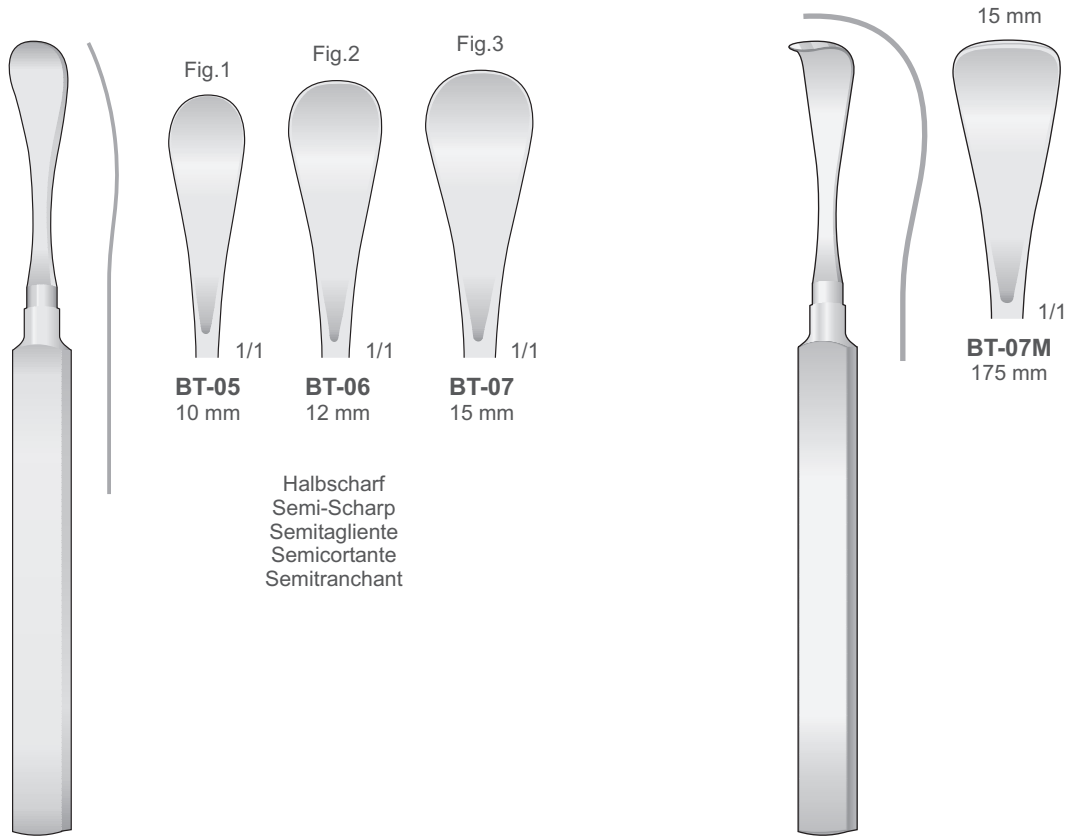

Halbscharf
Semi-Scharp
Semitagliente
Semicortante
Semitranchant

HENAHAN
BT-05/BT-07
175 mm

HENAHAN
BT-07M
175 mm

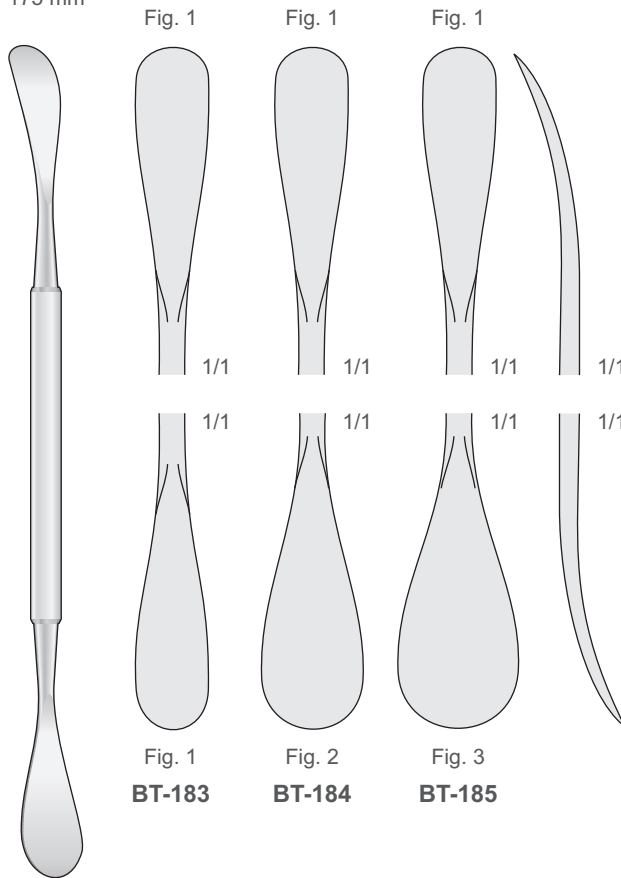

HENAHAN
BT-183/BT-185
200 mm

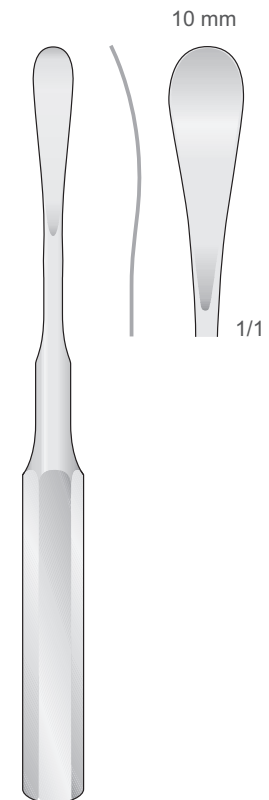

MOLT
MO-15
160 mm



Raspatorien - Elevatorien
Raspatories - Elevators
Periostotomi - Elevatori
Legras - Elevadores
Rugines - Elevateurs

Fig. 12S

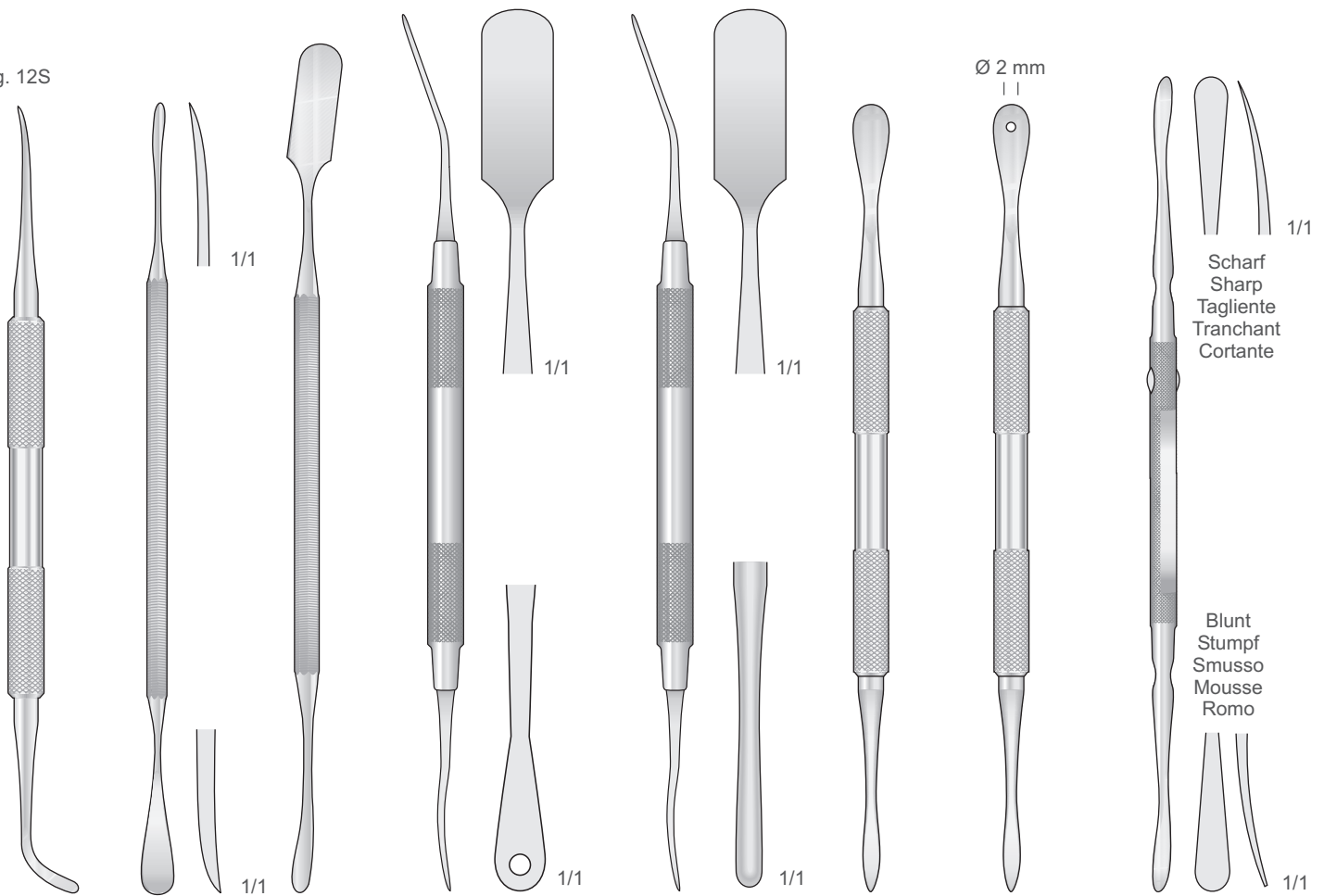

**BENNETT
KO-58**
175 mm

MOLT-9
175 mm

PR-3
190 mm

**PRICHARD
PR-3A**
180 mm

**PRICHARD
718-PR3**
175 mm

**MOLT
718-M9**
170 mm

**MOLT
MO-9A**
170 mm

FREER
180 mm

Scharf
Sharp
Tagliente
Tranchant
Cortante

Blunt
Stumpf
Smusso
Mousse
Romo

Raspatorien - Elevatorien
Raspatories - Elevators
Periostotomi - Elevatori
Legras - Elevadores
Rugines - Elevateurs

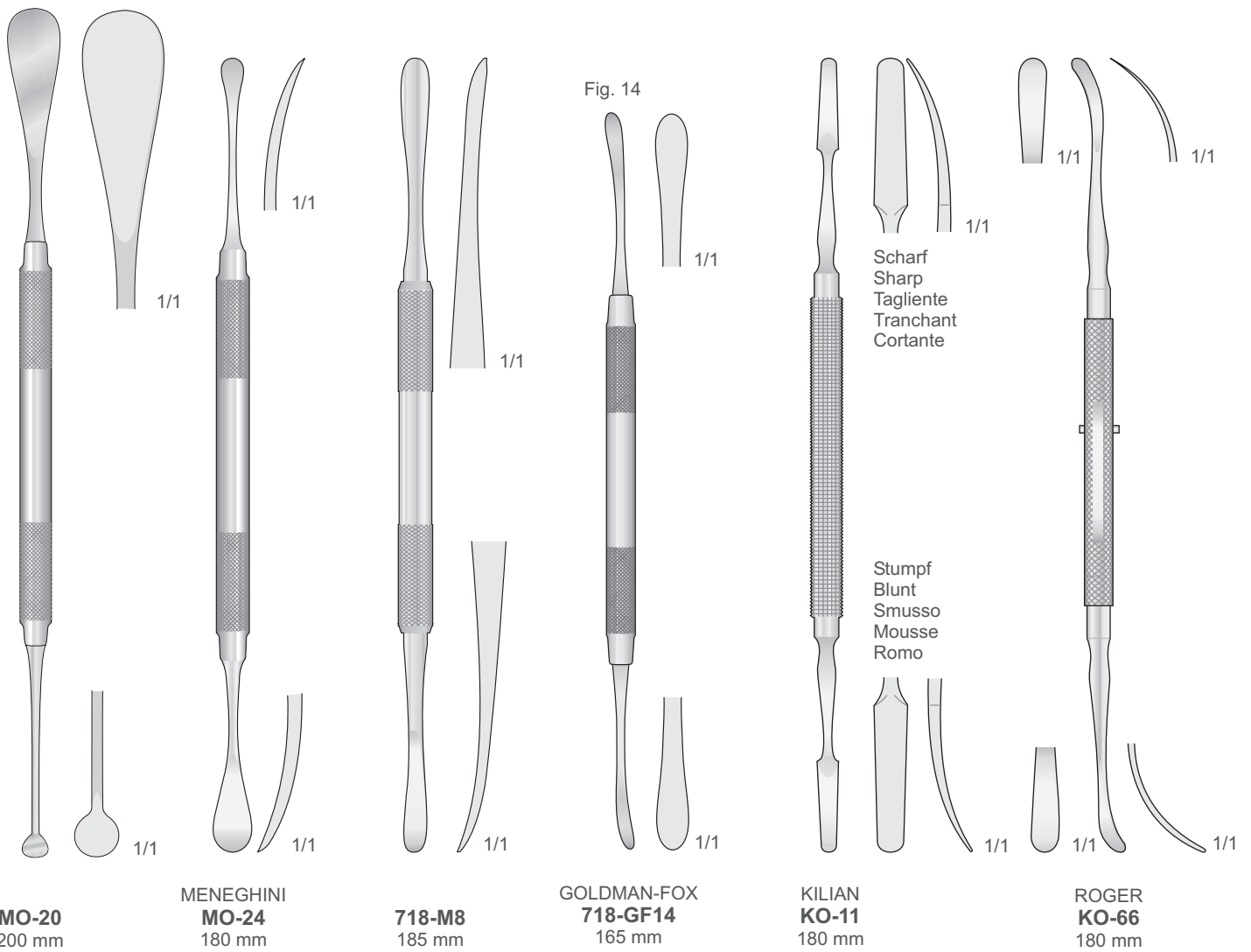



Raspatorien - Elevatorien
Raspatories - Elevators
Periostotomi - Elevatori
Legras - Elevadores
Rugines - Elevateurs

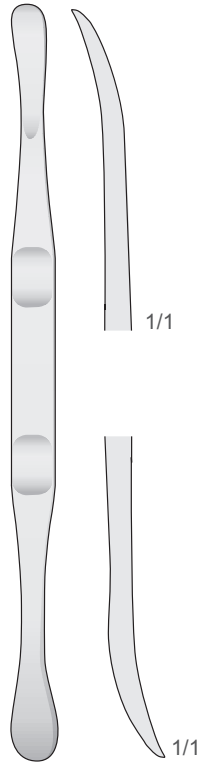

**BABBUSH
KO-20**
180 mm

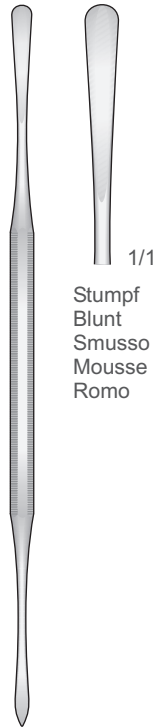

ES-27
160 mm

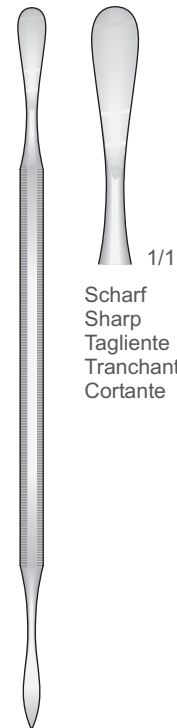

HB
160 mm

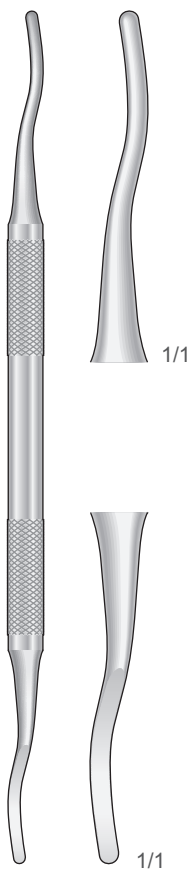

**HOPKINS
718-191**
185 mm

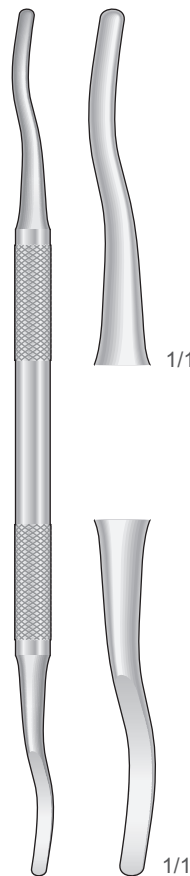

**HOPKINS
718-192**
185 mm

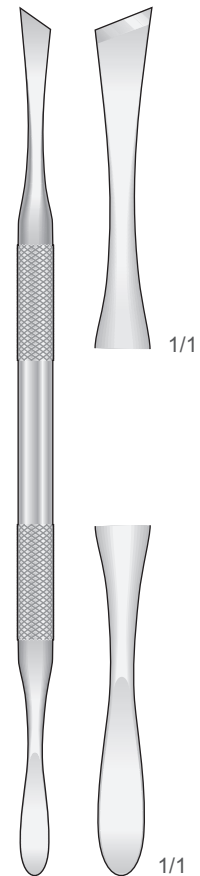

**MEAD
718-223**
185 mm

1/1
Stumpf
Blunt
Smusso
Mousse
Romo

1/1
Scharf
Sharp
Tagliente
Tranchant
Cortante

Raspatorien - Elevatorien
Raspatories - Elevators
Periostotomi - Elevatori
Legras - Elevadores
Rugines - Elevateurs

Runder Hohlgriff 8 mm
Hollow Round Handle 8 mm
Manico tondo vuoto 8 mm
Mango hueco 8 mm
Manche rond vide 8 mm

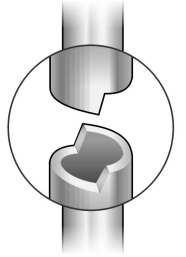

Sinus Lift Instrumente
Sinus Lift Instruments
Strumenti per rialzo del seno
Instrumentos para elevación de senos
Instruments pour les soulevés de sinus

Fig. 24G

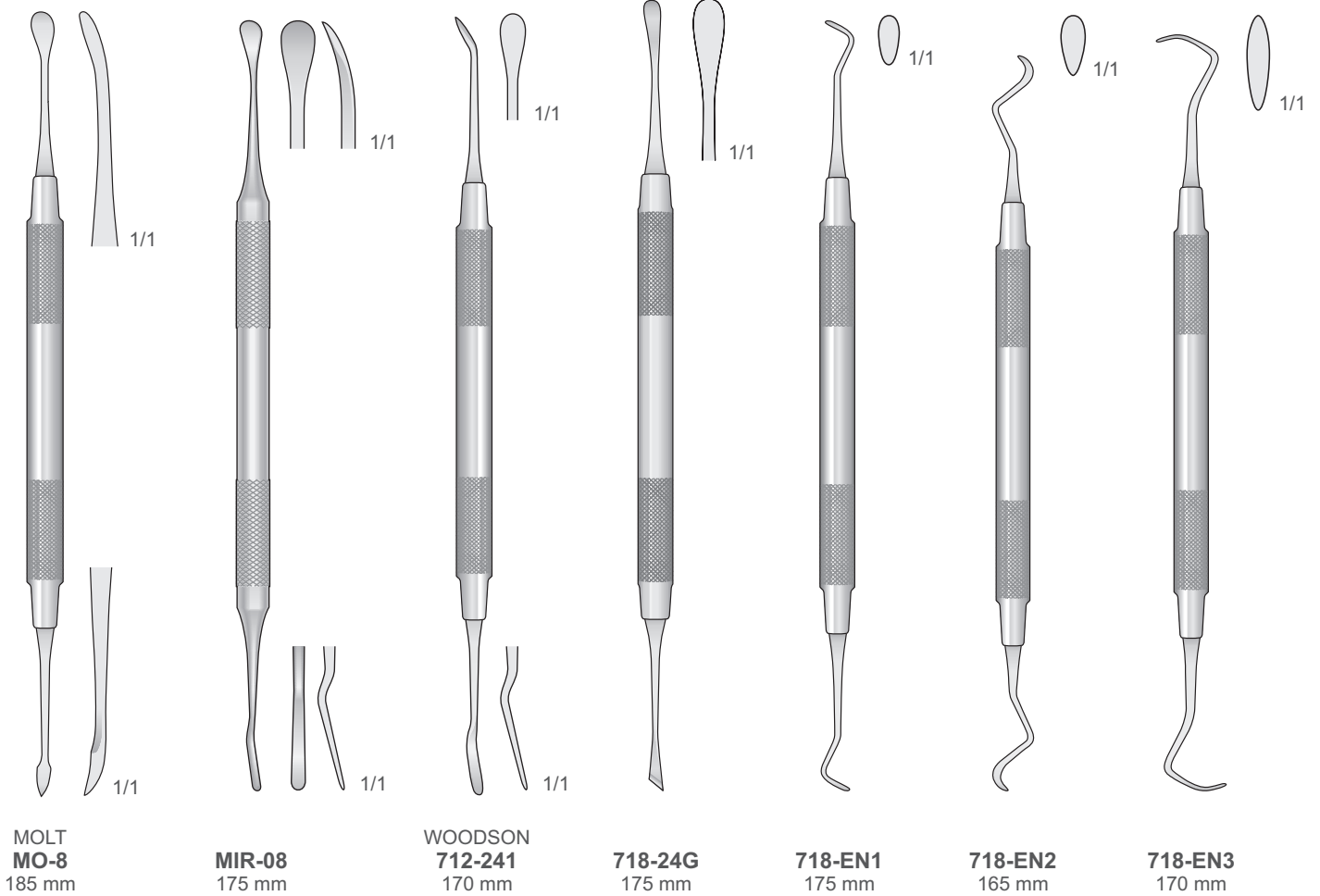



Sinus Lift Instrumente - Sinus Lift Instruments
Strumenti per rialzo del seno - Instrumentos para elevación de senos
Instruments pour les soulevés de sinus

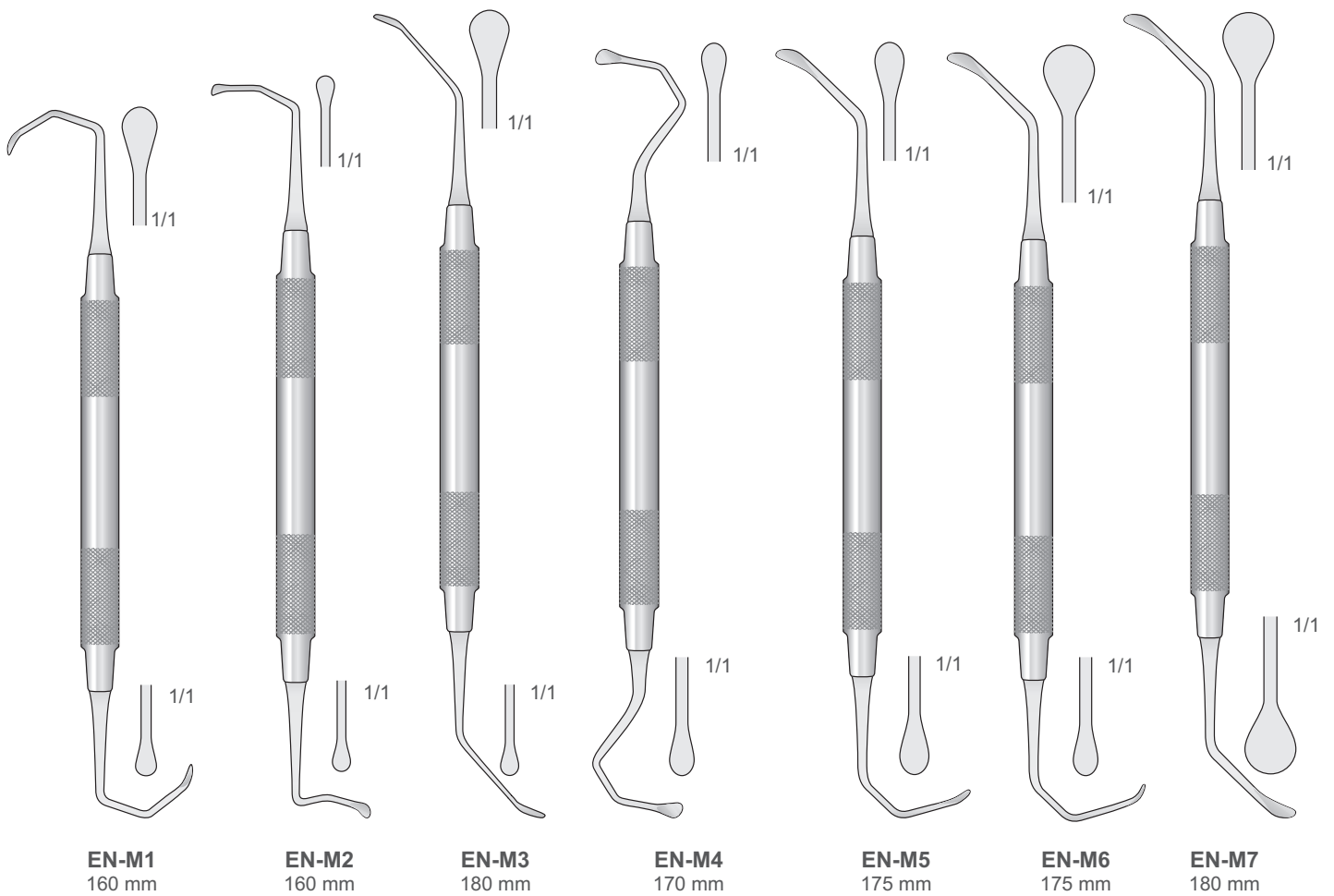



Curette

Sinus lifting

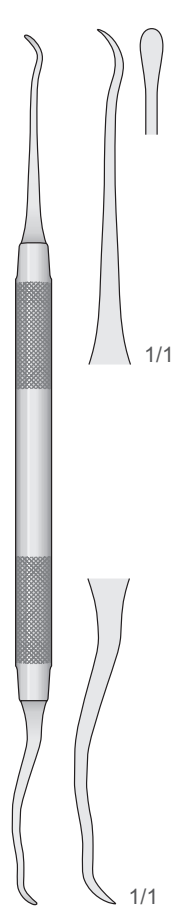

**MILLER-COLBURN
CU-MC1**
185 mm

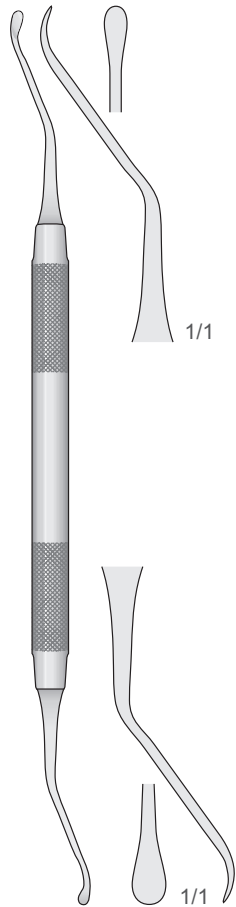

**MOLT
MO-12**
190 mm

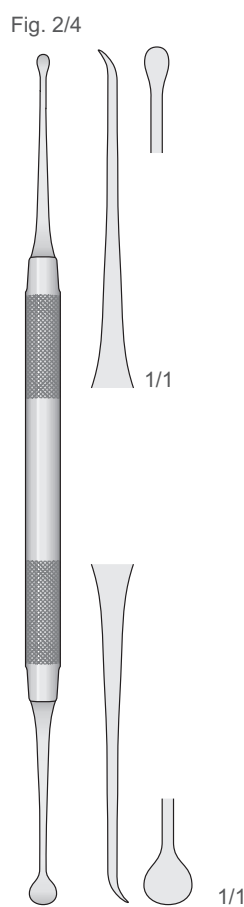

**MOLT
MO-10**
180 mm

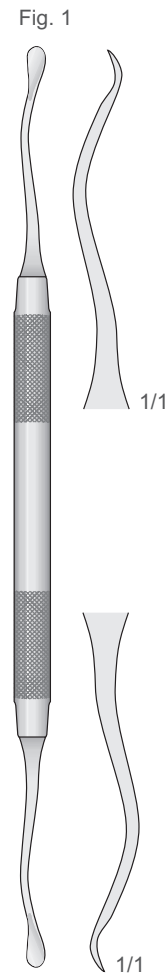

SL-1
200 mm

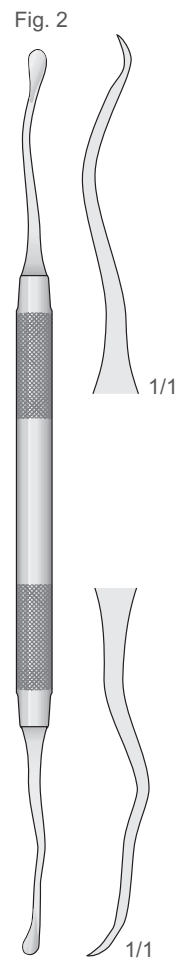

SL-2
195 mm

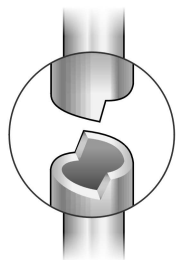

Runder Hohlgriff 8 mm
Hollow Round Handle 8 mm
Manico tondo vuoto 8 mm
Mango hueco 8 mm
Manche rond vide 8 mm

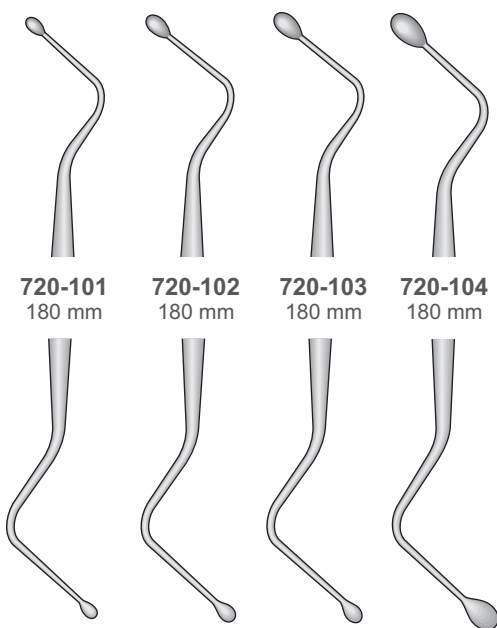
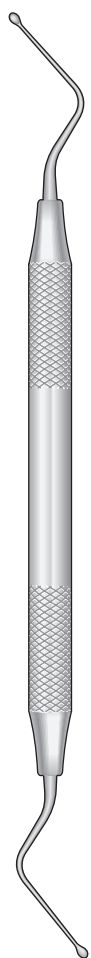

720-101
180 mm

720-102
180 mm

720-103
180 mm

720-104
180 mm

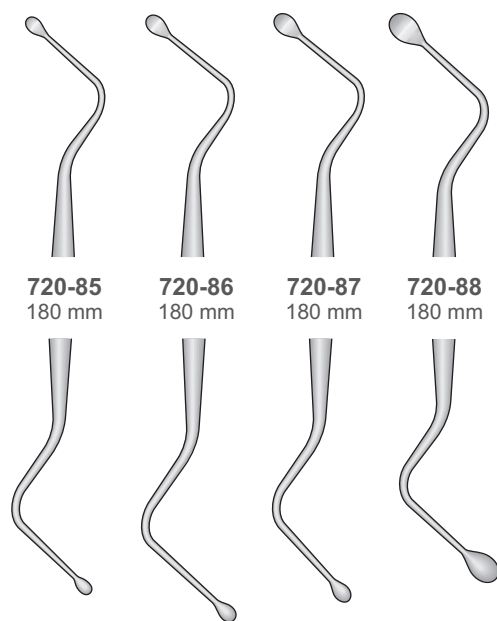

720-85
180 mm

720-86
180 mm

720-87
180 mm

720-88
180 mm

HEMINGWAY
720-101/720-104
180 mm

LUCAS
720-85/720-88
180 mm

Löffel
Curettes
Cucchiai
Cucharillas
Curettes

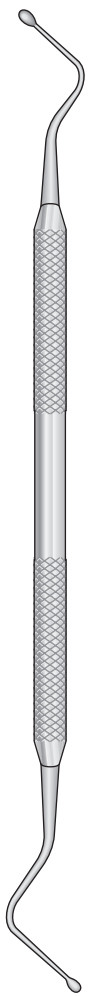

**HEMINGWAY
C-1**
170 mm

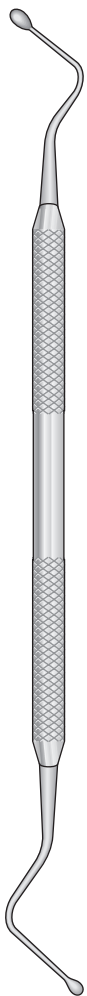

**HEMINGWAY
C-2**
170 mm

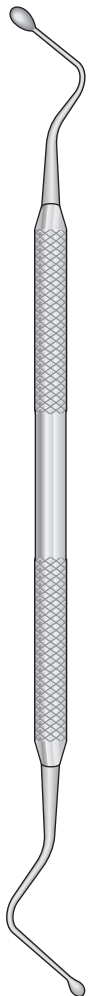

**HEMINGWAY
C-3**
170 mm

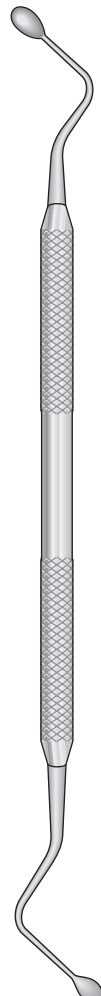

**HEMINGWAY
C-4**
170 mm

Wundhachen Mandibular
Mandibular Nerve Diplace
Per spostamento
nervo mandibolare
Para nero mandibular

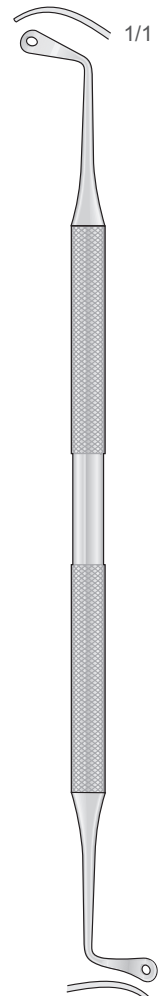

SL-21
165 mm



Löffel
Curettes
Cucchiai
Cucharillas
Curettes

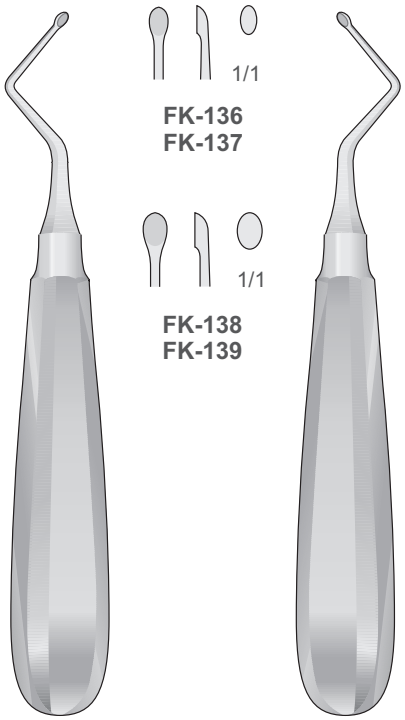

KERPEL
FK-136
FK-138
145 mm

KERPEL
FK-137
FK-139
145 mm



DL-50
155 mm

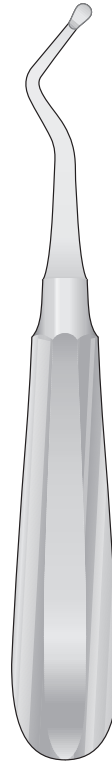

DL-51
150 mm



DL-52
150 mm

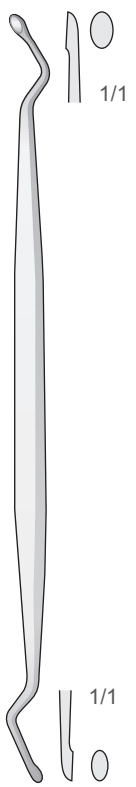

FK-83
160 mm

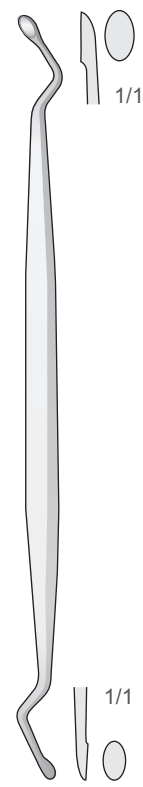

JANSEN
FK-84
160 mm

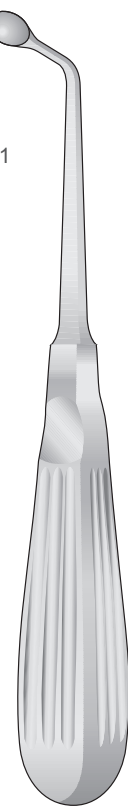
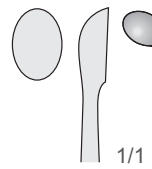

UFFENORDE
FK-188
170 mm

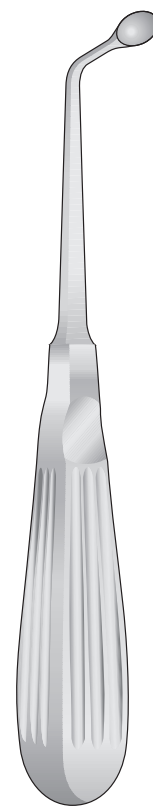

UFFENORDE
FK-189
170 mm

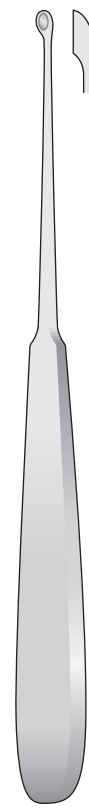
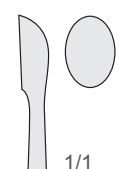

WILLIGER
FK-197/FK-198
170 mm

Fig. 00
3,4 mm
1/1
FK-197

Fig. 1
5,2 mm
1/1
FK-198



Löffel
Curettes
Cucchiai
Cucharillas
Curettes

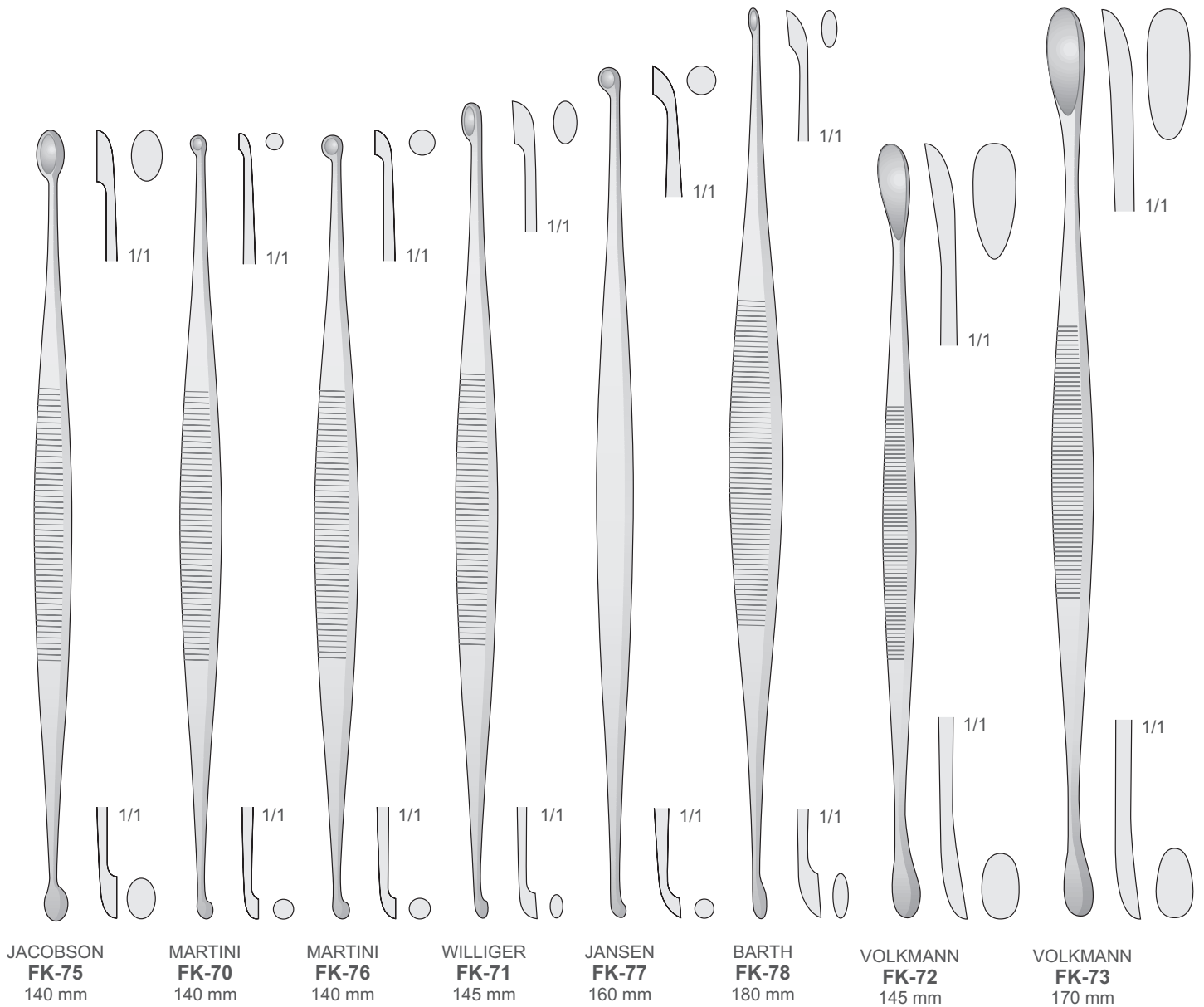

**JACOBSON
FK-75**
140 mm

**MARTINI
FK-70**
140 mm

**MARTINI
FK-76**
140 mm

**WILLIGER
FK-71**
145 mm

**JANSEN
FK-77**
160 mm

**BARTH
FK-78**
180 mm

**VOLKMANN
FK-72**
145 mm

**VOLKMANN
FK-73**
170 mm

Löffel
Curettes
Cucchiai
Cucharillas
Curettes

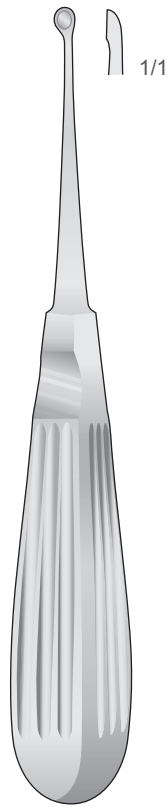

VOLKMANN
FK-60/FK-67
170 mm

- | | | | |
|---------------------------------------------|--------------------------------------------|-------------------------------------------|-------------------------------------------|
| Fig.0000
2,8 mm
○ 1/1
FK-60 | Fig.000
3,6 mm
○ 1/1
FK-61 | Fig.00
4,4 mm
○ 1/1
FK-62 | ,Fig.0
5,2 mm
○ 1/1
FK-63 |
| Fig.1
6,8 mm
○ 1/1
FK-64 | Fig.2
8,5 mm
○ 1/1
FK-65 | Fig.3
10 mm
○ 1/1
FK-66 | Fig.4
11,5 mm
○ 1/1
FK-67 |

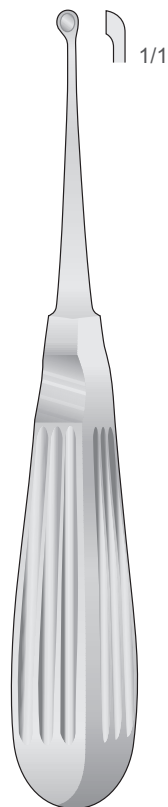

BRUNS
FK-110/FK-116
165 mm

- | | | |
|-----------------------------|-----------------------------|----------------------------|
| 3 mm
○
FK-110 | 4 mm
○
FK-111 | 5 mm
○
FK-112 |
| 6 mm
○
FK-113 | 8 mm
○
FK-114 | |
| 10 mm
○
FK-115 | 12 mm
○
FK-116 | |

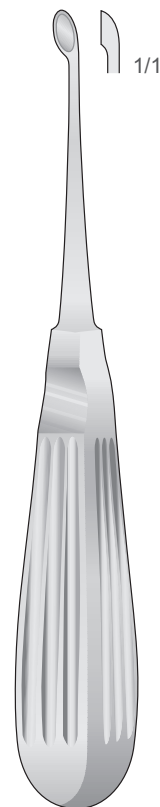

SCHEDE
FK-120/FK-126
170 mm

- | | | |
|------------------------------|------------------------------|------------------------------|
| 2,5 mm
○
FK-120 | 3,4 mm
○
FK-121 | 4,2 mm
○
FK-122 |
| 5,2 mm
○
FK-123 | 6,3 mm
○
FK-124 | |
| 7,4 mm
○
FK-125 | 8 mm
○
FK-126 | |

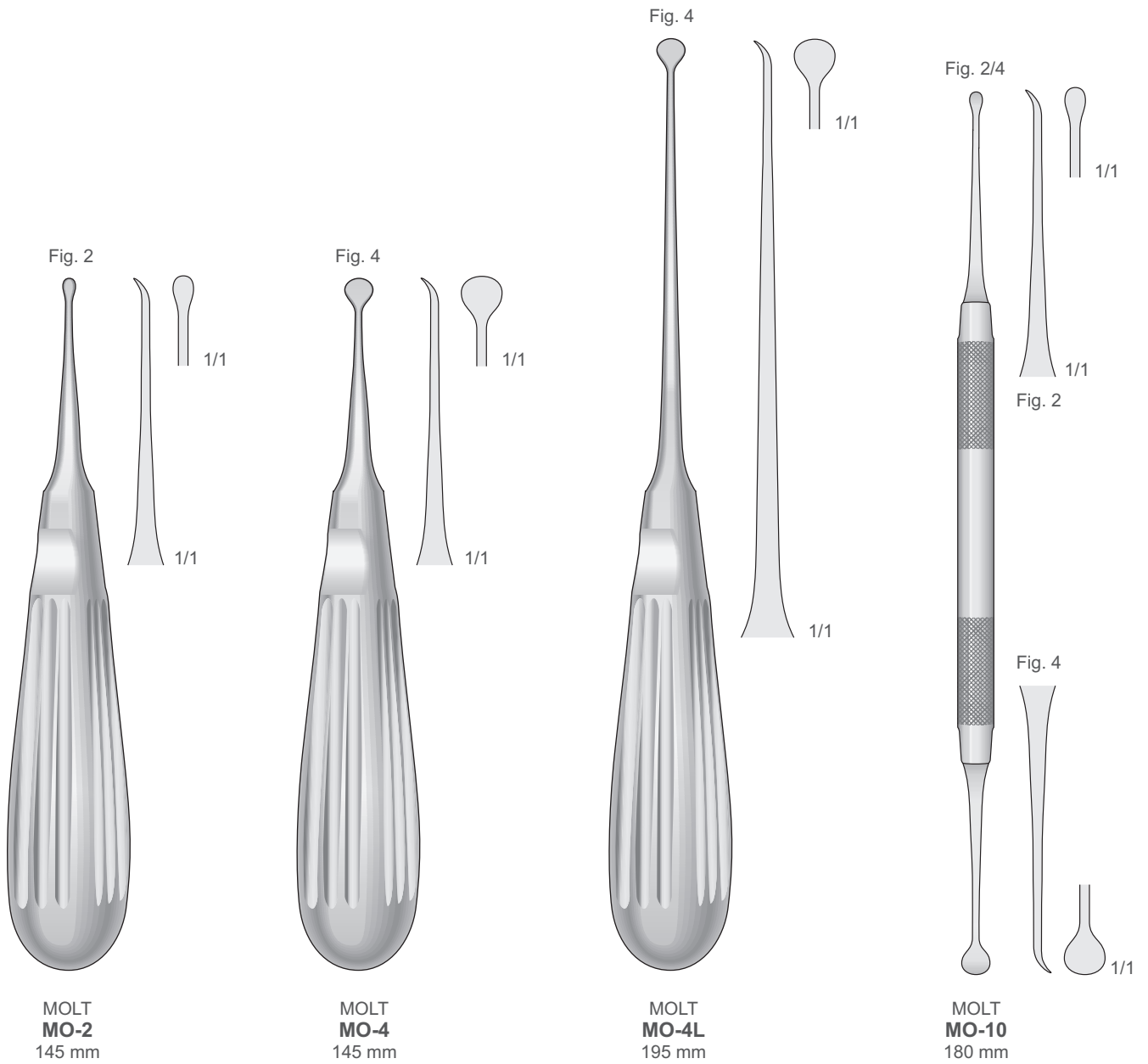



Knochenfeilen
Bone Files
Lime per osso
Limas para huesos
Rapes à os

Fig. 67

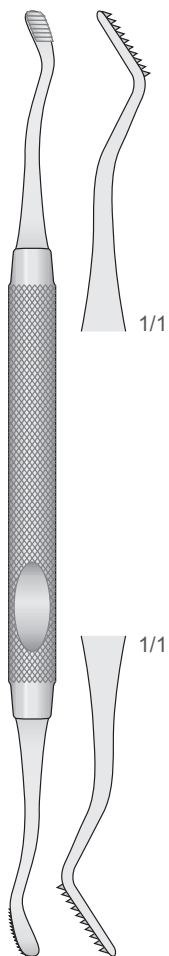

**HOWARD
DO-1**
180 mm

Fig. 45

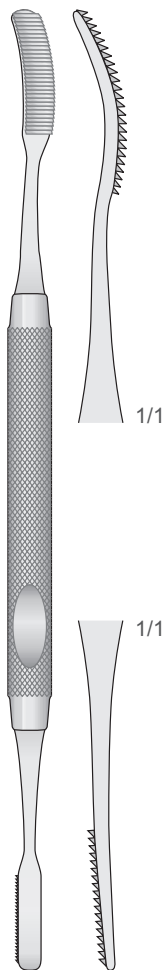

**MILLER
DO-2**
185 mm

Fig. 52

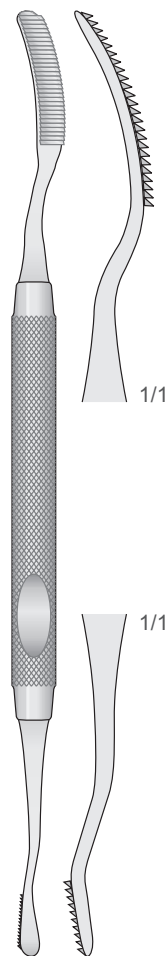

**MILLER
DO-3**
180 mm

Fig. 12

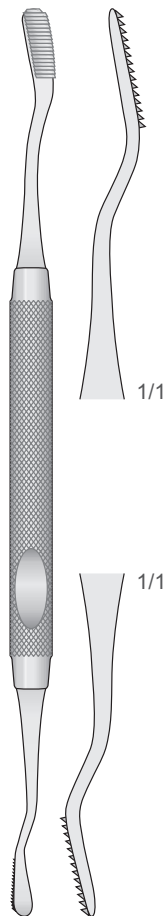

**HOWARD
DO-4**
170 mm

Fig. 12A

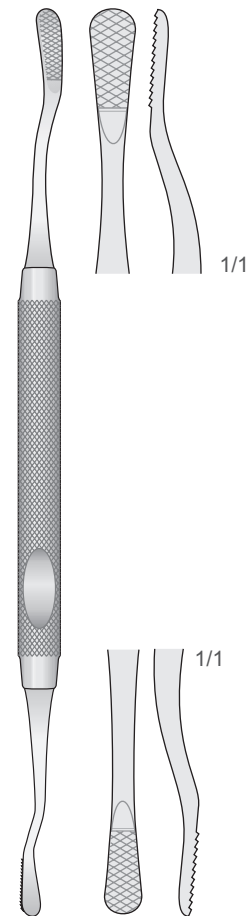

**MILLER
DO-4C**
170 mm

Fig. 64

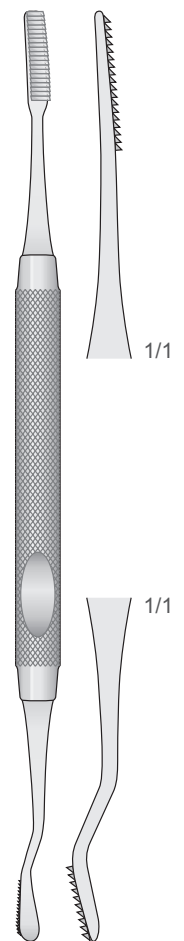

**MILLER
DO-5**
175 mm

Knochenfeilen
Bone Files
Lime per osso
Limas para huesos
Rapes à os

Runder Hohlgriff 8 mm
Hollow Round Handle 8 mm
Manico tondo vuoto 8 mm
Mango hueco 8 mm
Manche rond vide 8 mm

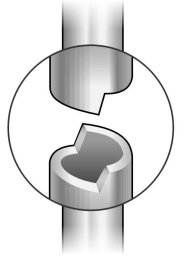

Parodontal Feilen
Periodontal Files
Lime parodontali
Limas periodontales
Limes parodontales

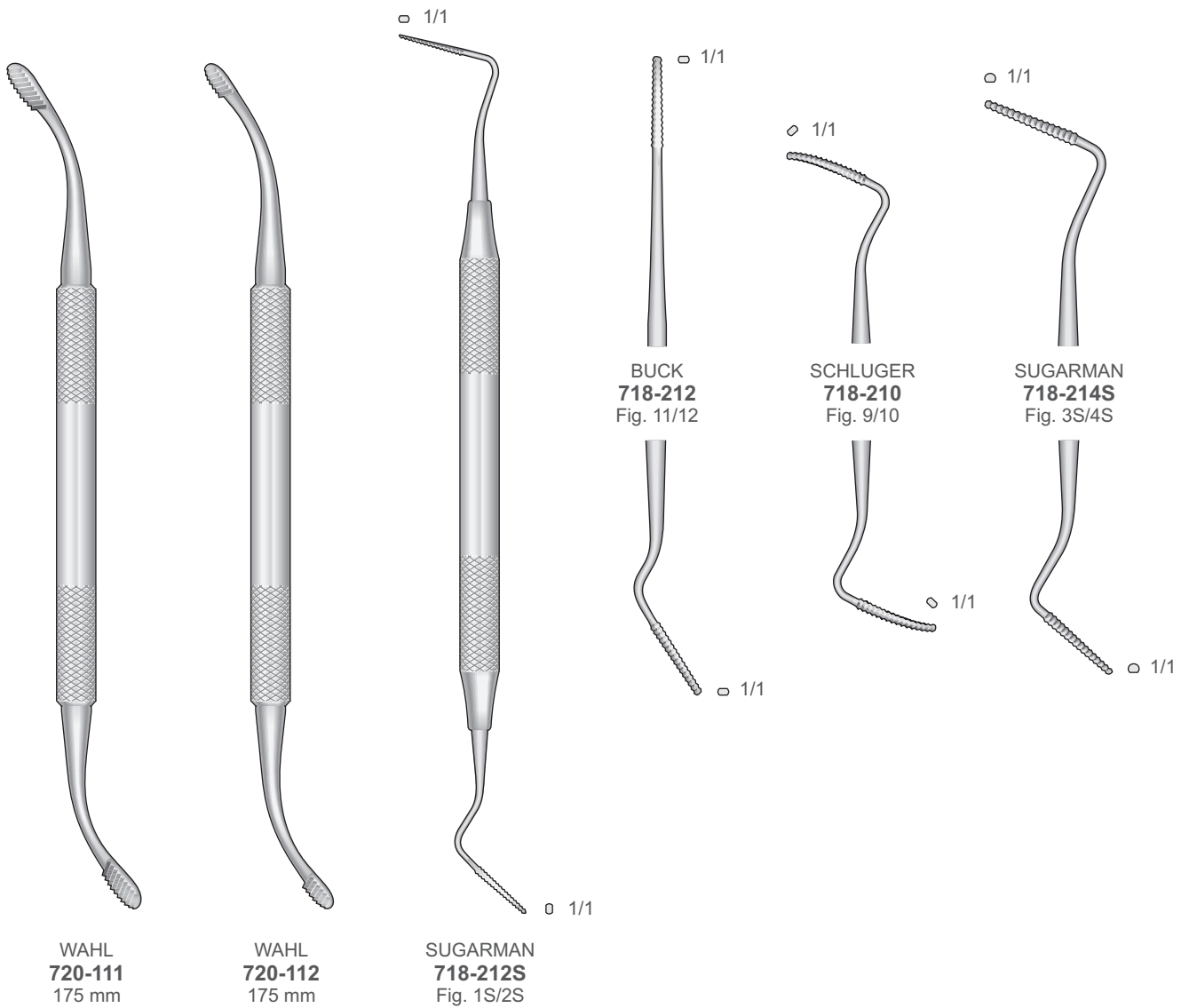



Gewebezängchen
Tissue Nippers
Tronchesi per gengive e tessuti
Pinzas para cortar tejidos
Pince pour couper le tissu

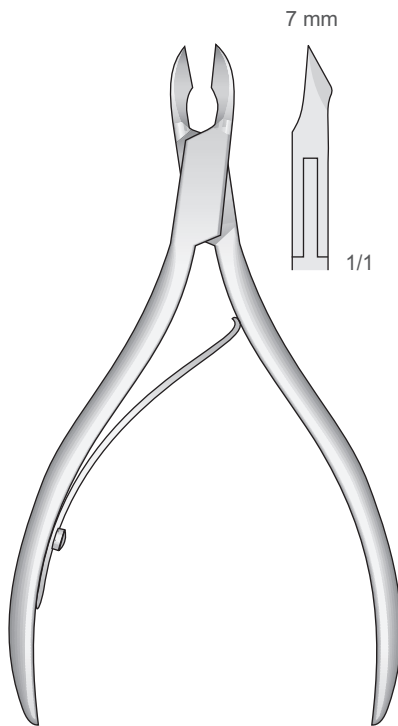

**CHOEN
LX-60**
105 mm

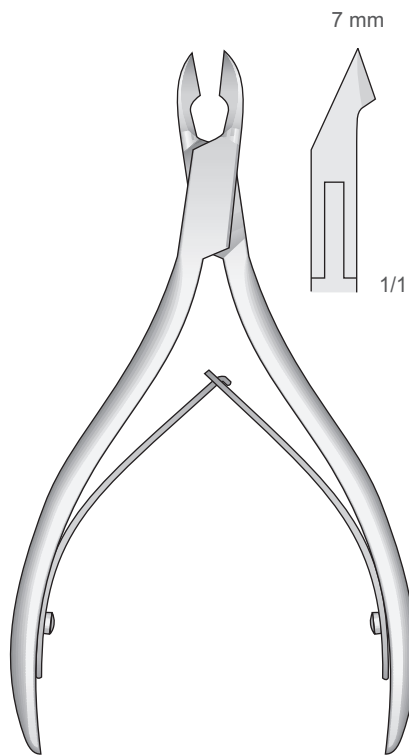

**ILIC
LX-50**
115 mm

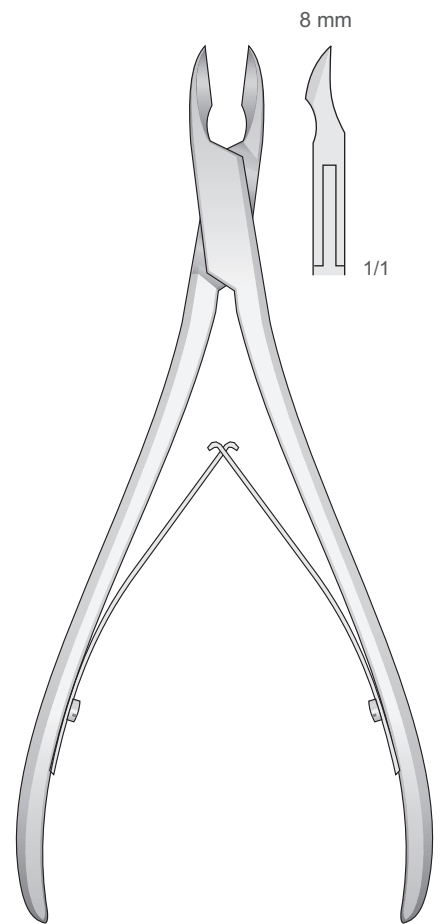

LX-52
140 mm

Hohlmeißelzangen
Bone rongeurs
Pinze ossivore
Pinzas-gubias
Pincers-gouges

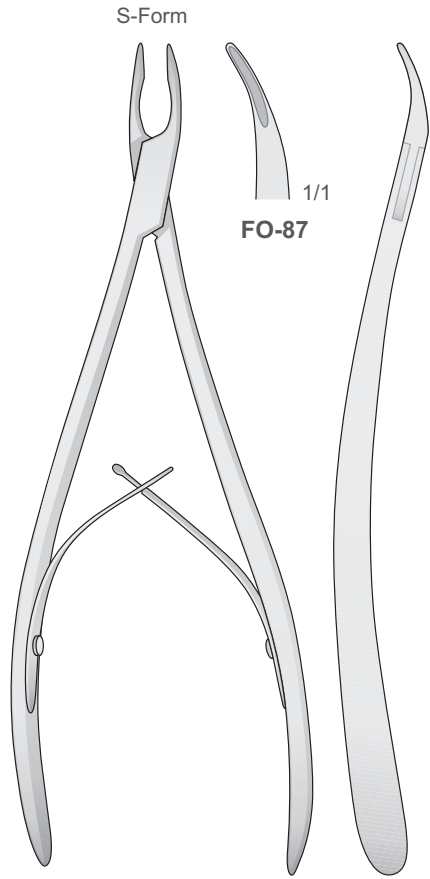

STELLBRINK
FO-87
190 mm



STELLBRINK
FO-88/FO-89
170 mm

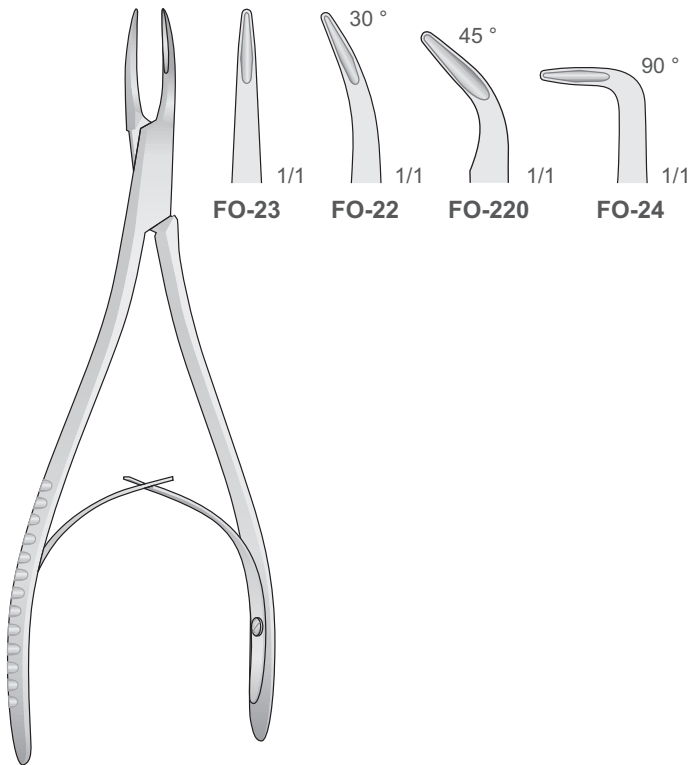

MINI-FRIEDMANN
FO-22/FO-220
150 mm

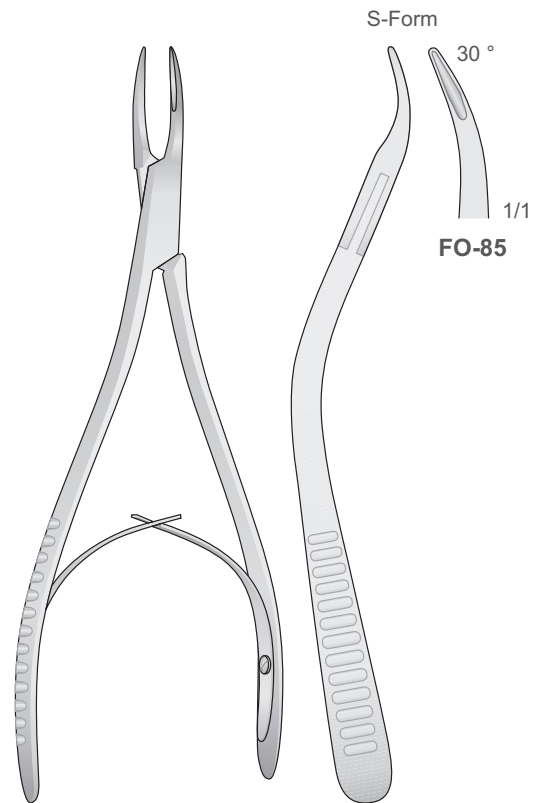

MINI-FRIEDMANN
FO-85
145 mm



Hohlmeißelzangen
Bone rongeurs
Pinze ossivore
Pinzas-gubias
Pincas-gouges

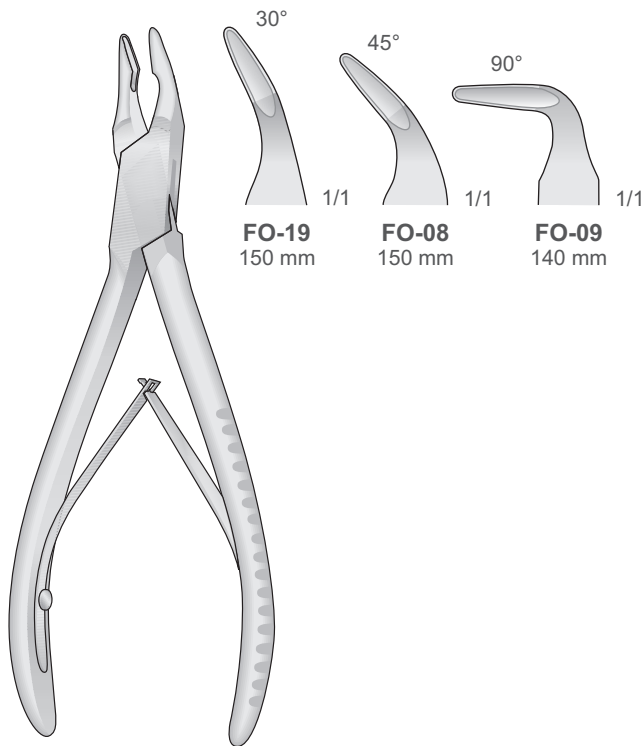

BLUMENTHAL
FO-08/FO-19

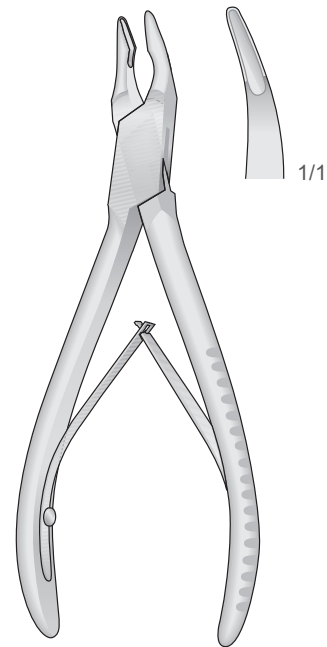

MINI FRIEDMAN
FO-15
120 mm

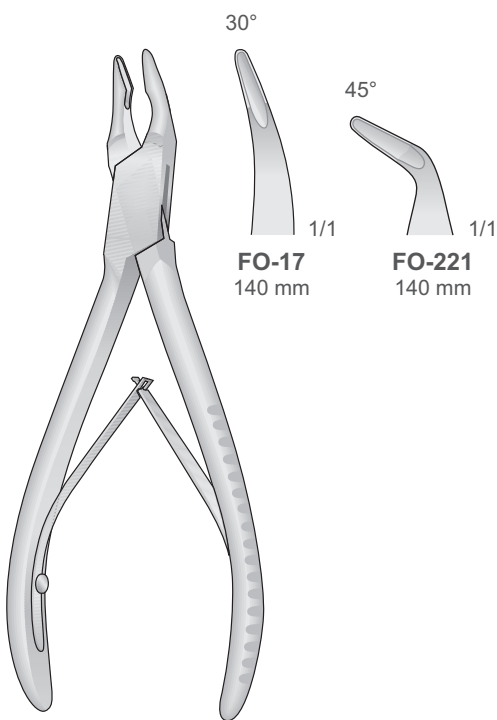

FRIEDMANN
FO-17/FO-221
140 mm

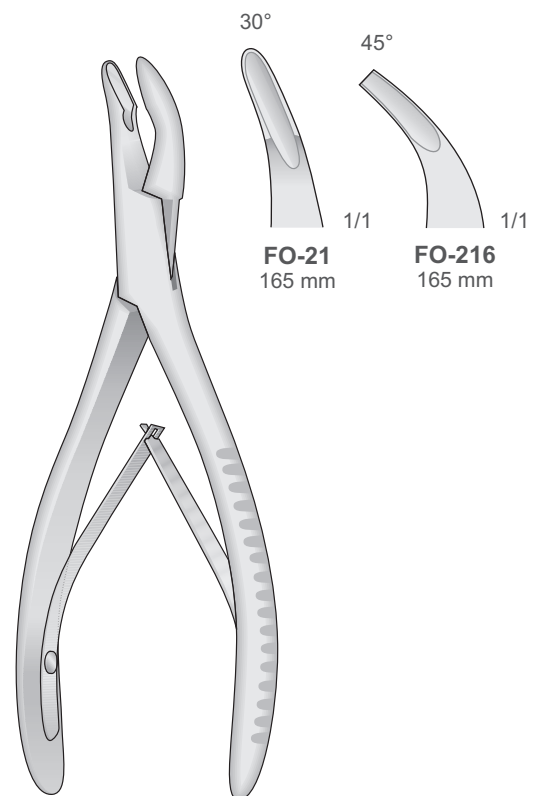

MEAD
FO-21/FO-216
165 mm



Hohlmeißelzangen
Bone rongeurs
Pinze ossivore
Pinzas-gubias
Pinces-gouges

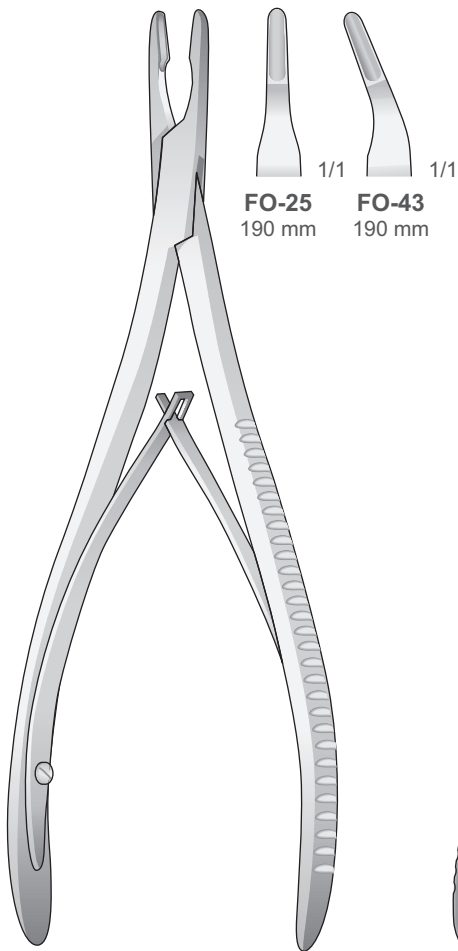

FO-25 190 mm
FO-43 190 mm

LEMPERT
FO-25/FO-43
190 mm

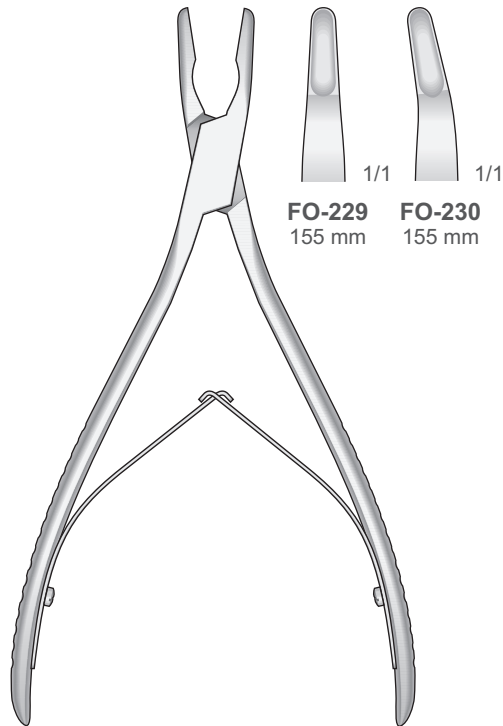

FO-229 155 mm
FO-230 155 mm

LEMPERT
FO-229/FO-230
155 mm

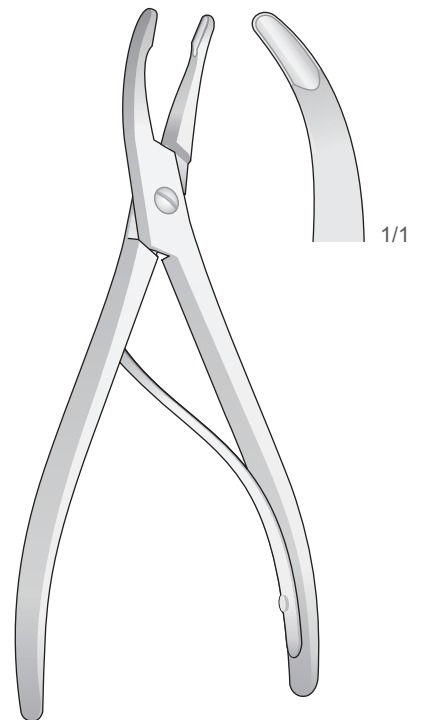

LUER
FO-18
155 mm



Hohlmeißelzangen
Bone rongeurs
Pinze ossivore
Pinzas-gubias
Pincès-gouges

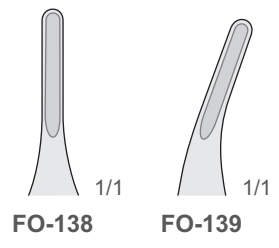
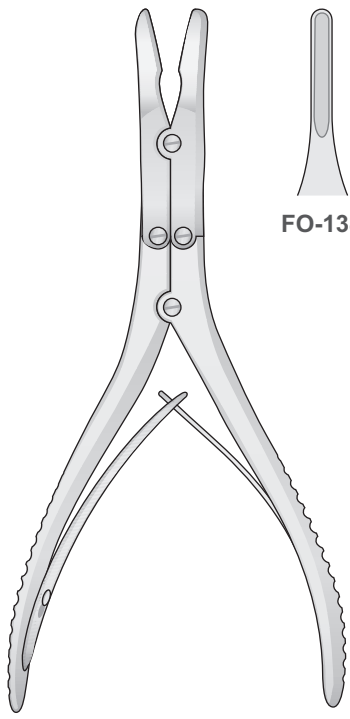

RUSKIN
FO-138/FO-139
150 mm

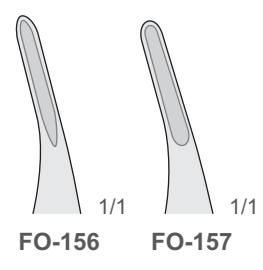
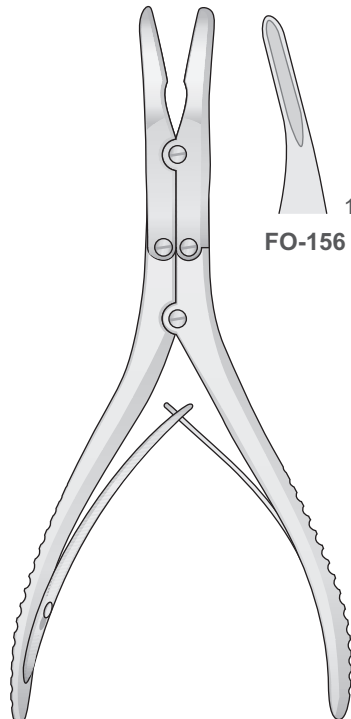

KLEINERT-KUTZ
FO-156/FO-157
155 mm

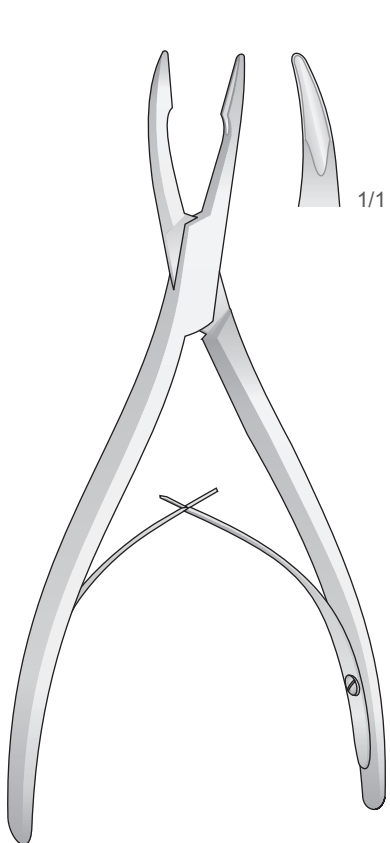

FRIEDMANN
FO-16
160 mm

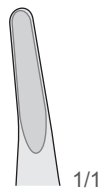
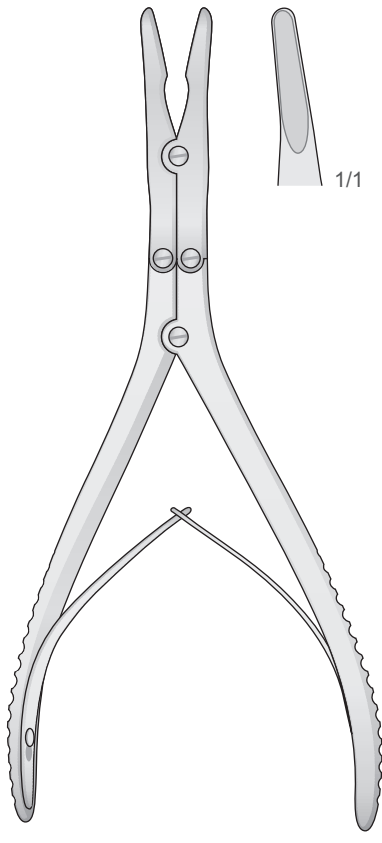

BEYER
FO-20
180 mm

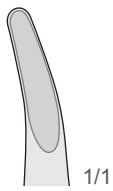
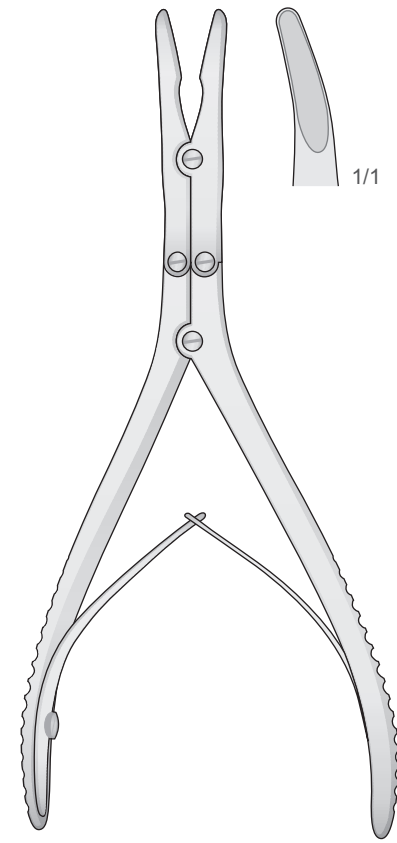

ZAUFAL-JANSEN
FO-34
180 mm

Hohlmeißelzangen
Bone rongeurs
Pinze ossivore
Pinzas-gubias
Pincers-gouges

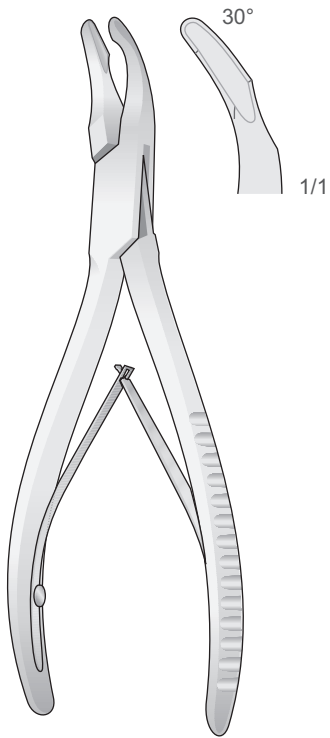

CLEVELAND
FO-231 140 mm
FO-232 170 mm

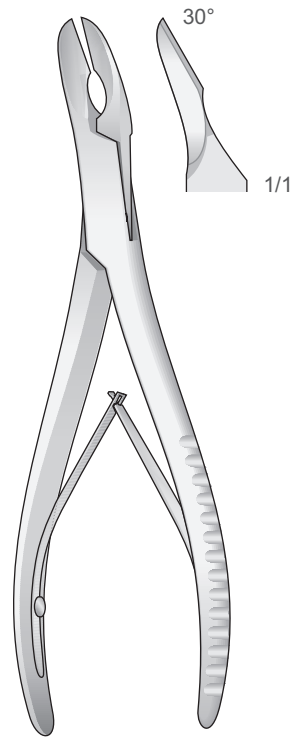

CLEVELAND
FO-233 150 mm
FO-234 170 mm

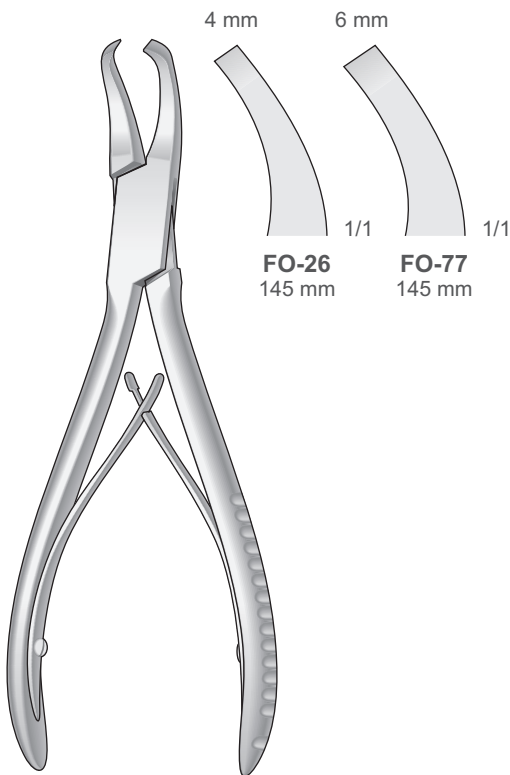

GARDNER
FO-26/FO-77
145 mm

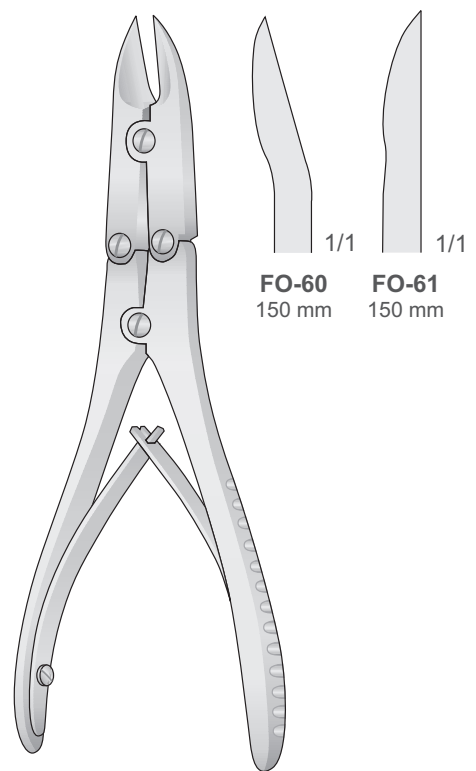

BÖHLER
FO-60/FO-61
150 mm

Punches - Stanzen

Bone cutting forceps
for opening the Sinus
Strumento tagliente per
aumentare il volume del seno

Knochensplitterzangen
Bone cutting forceps
Pinze ossivore
Pinza cortantes para huesos
Pincas coupantes à os

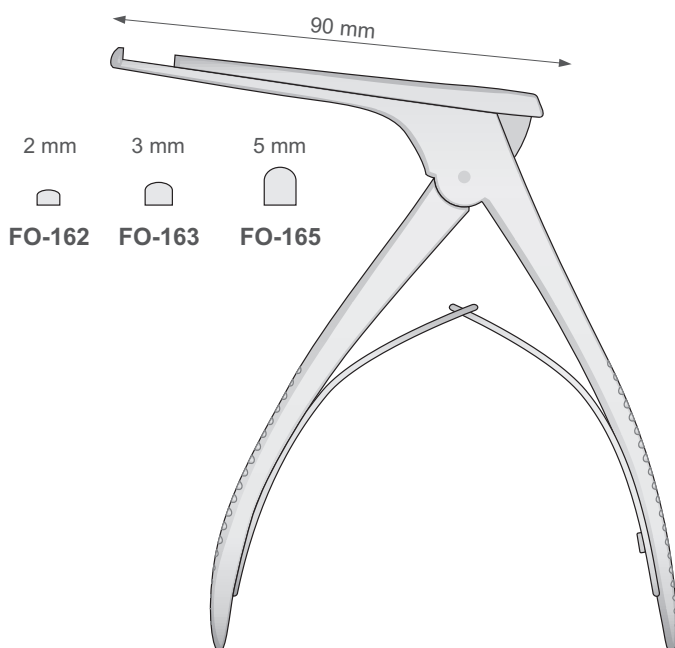

KERRISON
FO-162 2 mm
FO-163 3 mm
FO-165 5 mm

Bone cutting forceps
for opening the Sinus
Strumento tagliente per
aumentare il volume del seno

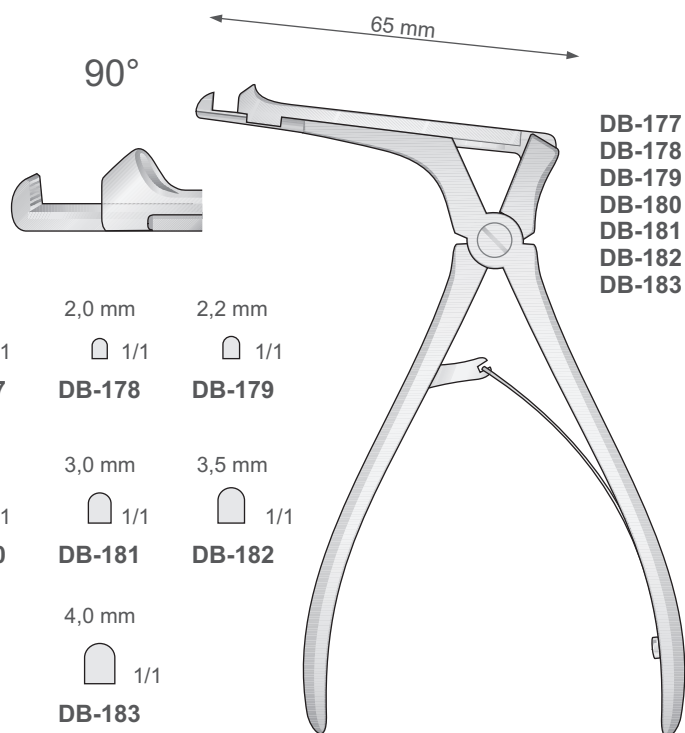

CITELLI
DB-177/DB-183

Fig. R-18

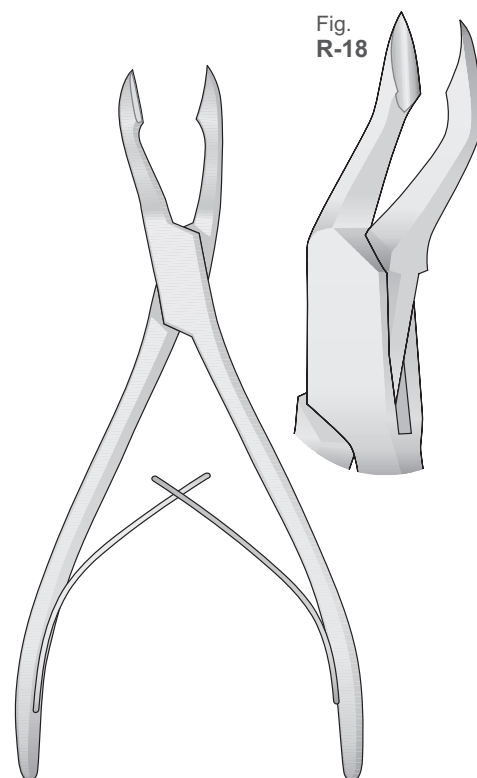

FO-33
175 mm

.11

Diagnostik, Parodontologie, Konservierung
Diagnostic, Periodontal, Restorative
Diagnostica, Parodontologia, Conservativa
Diagnóstico, Parodontología, Conservativo
Diagnostic, Parodontologie, Conservateur

Zahnärztliche Chirurgie
Dental surgery
Chirurgia dentale
Cirugia dental
Chirurgie dentaire





Zahnsonden
Explorers
Sonde
Sondas
Explorateurs

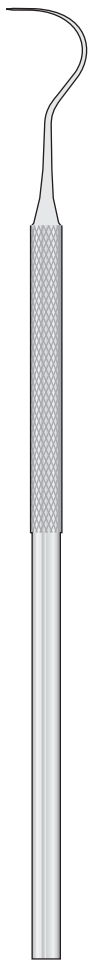

SO-1
Fig. 23



SO-2
Fig. 11



SO-3
Fig. 6

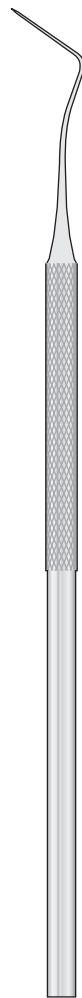

SO-4
Fig. 9

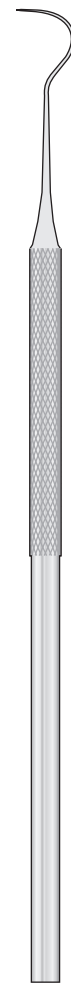

SO-5
Fig. 2

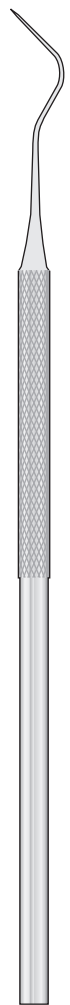

SO-6
Fig. 10



Zahnsonden
Explorers
Sonde
Sondas
Explorateurs

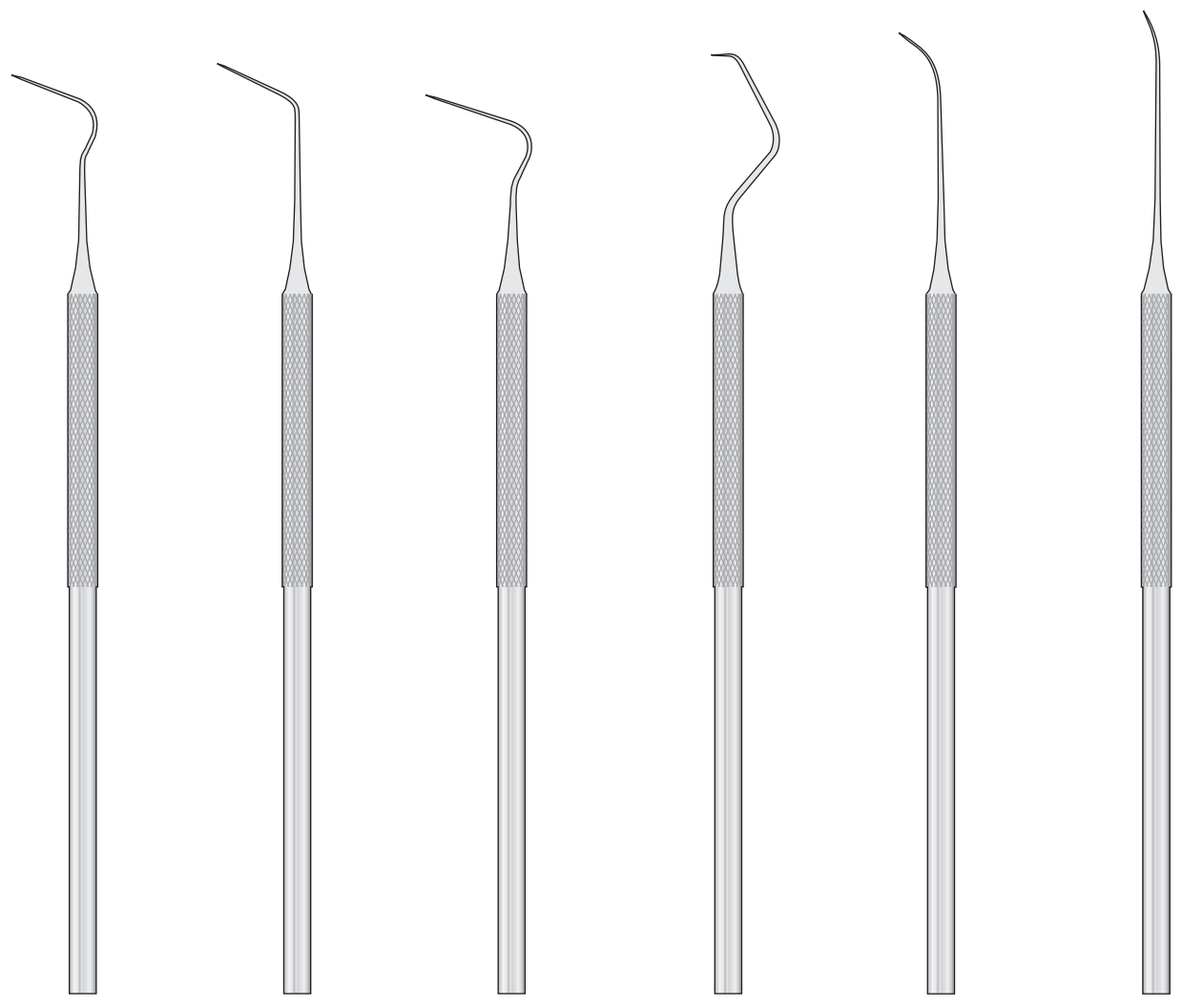

SO-7
Fig. 12

SO-8
Fig. 6A

SO-9
Fig. 8A

SO-10
Fig. 17A

SO-11
Fig. 3A

SO-12
Fig. 3

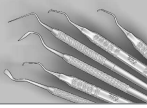

Parodontometer
Periodontal Probes
Sonde parodontali
Sondas parodontales
Sondes parodontales

**Do not sterilizing with ultra sound - Not Metal brushes
Non sterilizzare in ultrasuoni - No spazzola metallica**

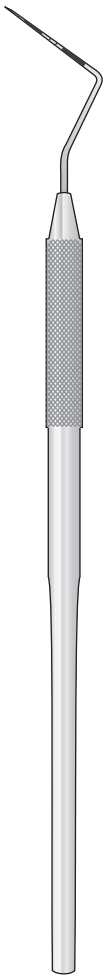
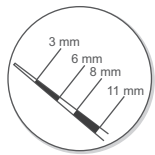

**CP-11
SM-11**
160 mm

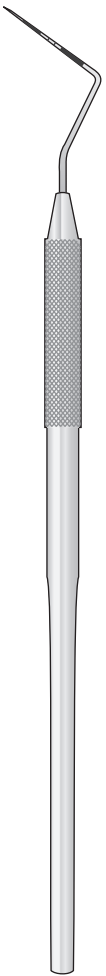
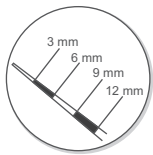

**CP-12
SM-12**
160 mm

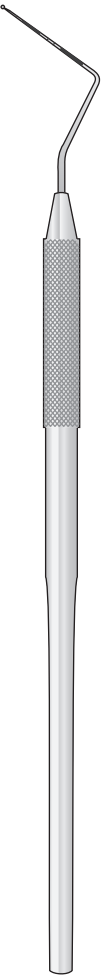
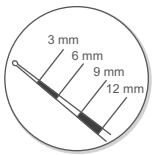

**CP-12S
SM-13**
160 mm

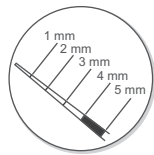

**CP-15UNC
SM-15**
160 mm

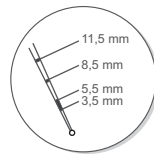

**WHO
SM-21**
160 mm

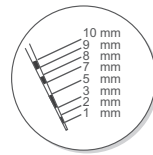

**CP-10
SM-19**
160 mm



Parodontometer
Periodontal Probes
Sonde parodontali
Sondas parodontales
Sondes parodontales

Sonden - Doppellendig
Explorers - Double end
Sonda doppia
Exploradores dobles
Explorateurs doubles



11/12 ODU
SO-20
165 mm

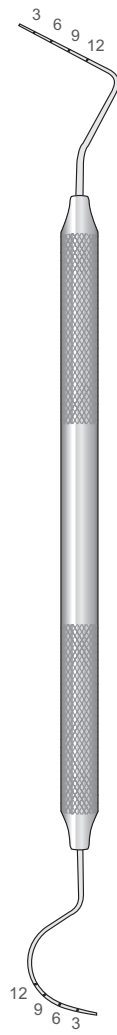

UT3/4 CATTONI
SM-20
165 mm

3 - 6 - 9 - 12



12 - 9 - 6 - 3

2QN NABERS
SM-22
175 mm

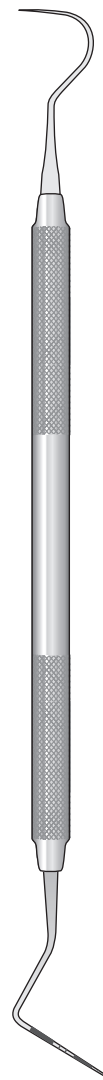
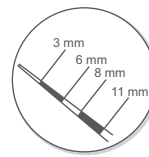

23 CP-11
EX-11

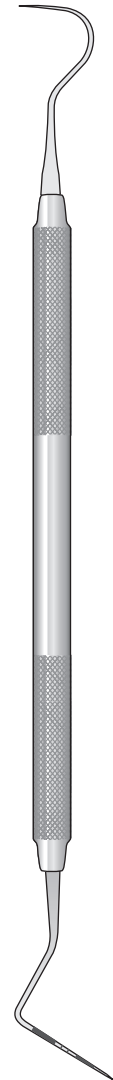
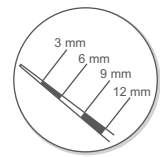

23 CP-12
EX-12

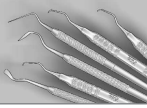

Parodontometer
Periodontal Probes
Sonde parodontali
Sondas parodontales
Sondes parodontales

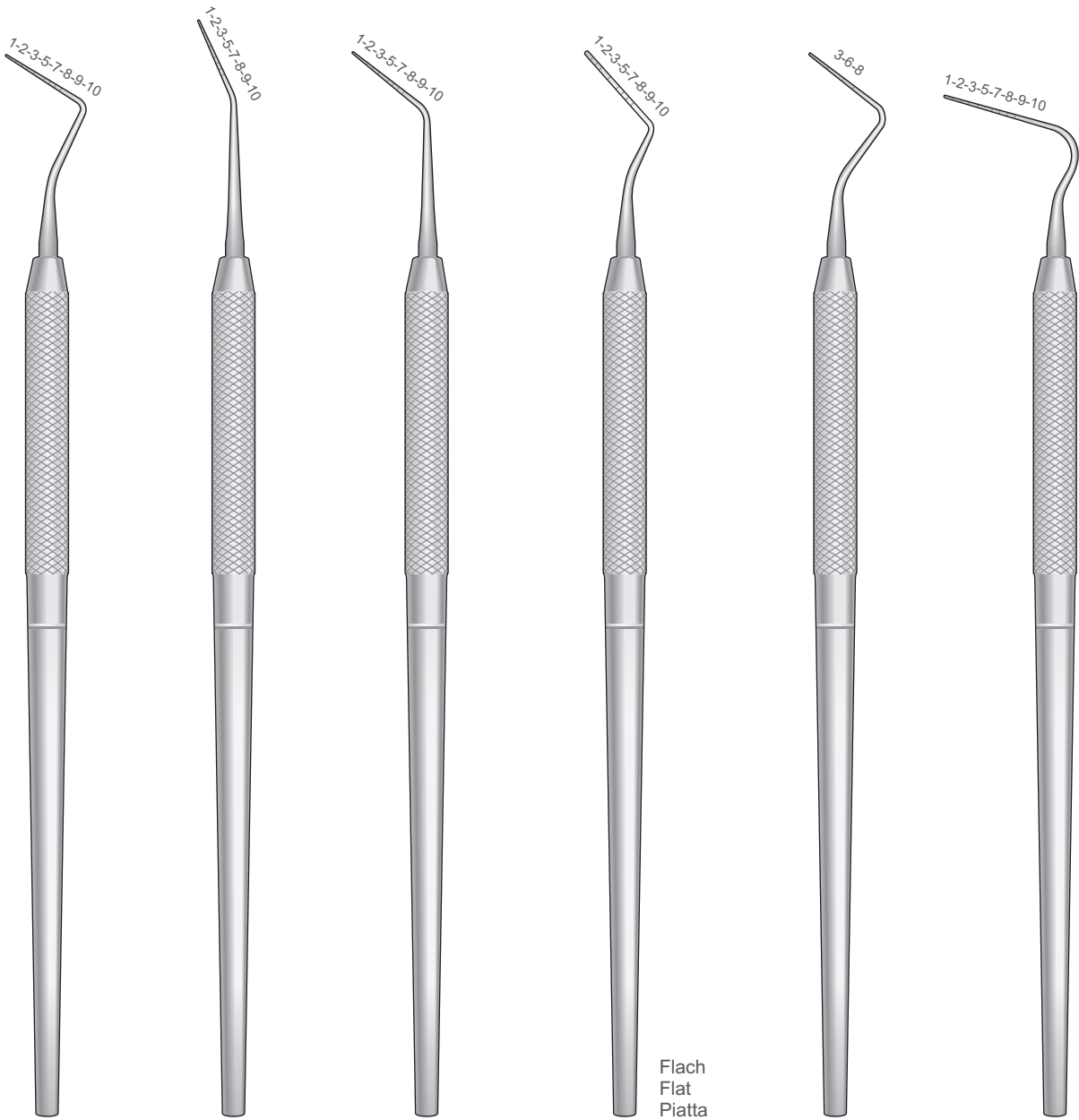

Flach
Flat
Piatta

**WILLIAMS
SM-1**

**MERRIT A
SM-2**

**MERRIT B
SM-3**

**GOLDMAN-FOX
SM-4**

**UNIVERSITY
OF MICHIGAN
SM-5**

**26 G
SM-6**



Nevinstrumente
Endodontic Instruments
Strumenti per trattamenti canalari
Instrumentos para nervios
Instruments à nerfs

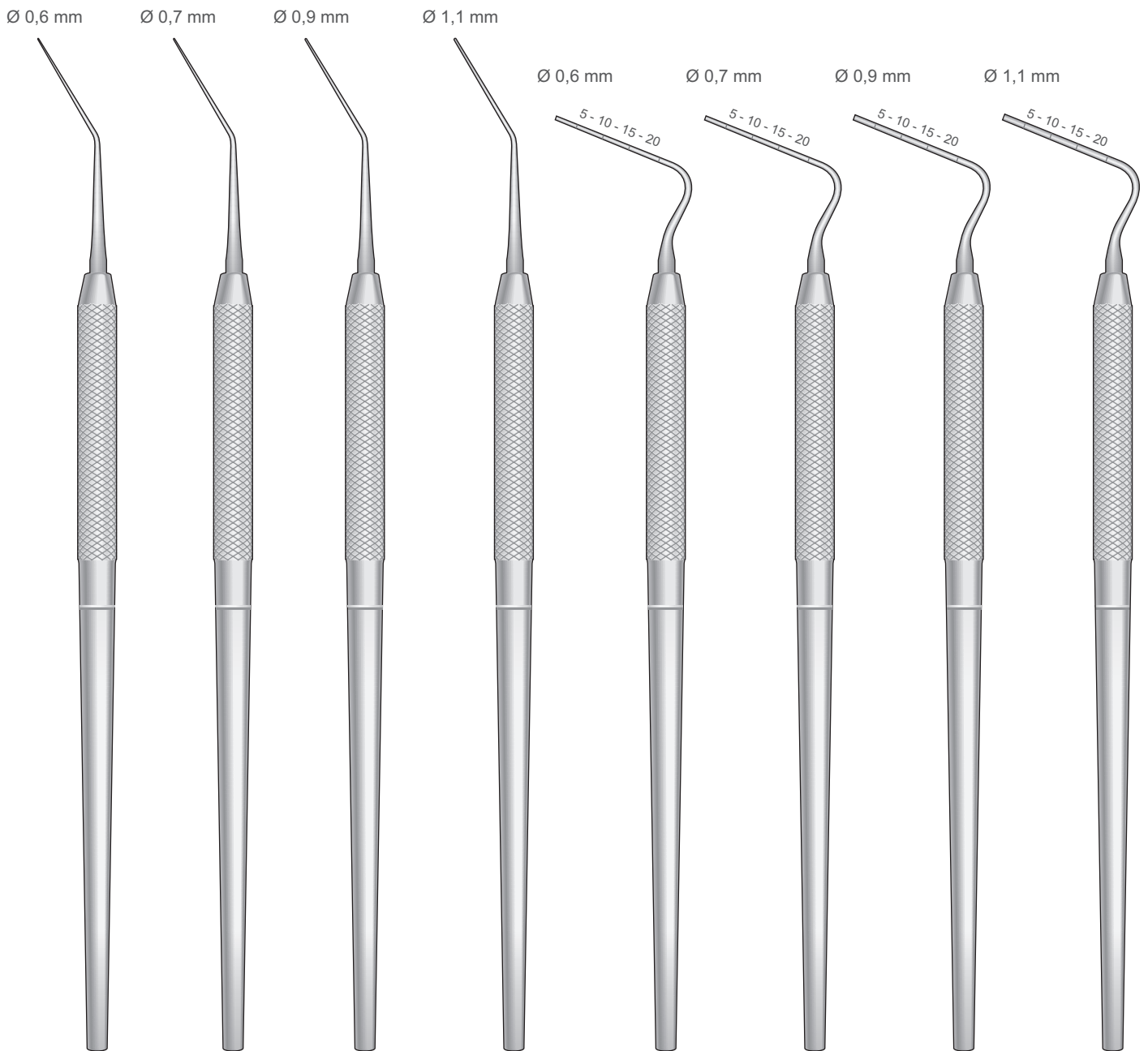

**LUKS
PL-1**
Fig.1

**LUKS
PL-2**
Fig.2

**LUKS
PL-3**
Fig.3

**LUKS
PL-4**
Fig.4

PZ-1
Fig.1

PZ-2
Fig.2

PZ-3
Fig.3

PZ-4
Fig.4

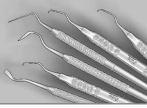

Nervinstrumente
Endodontic Instruments
Strumenti per trattamenti canalari
Instrumentos para nervios
Instruments à nerfs

Spreaders

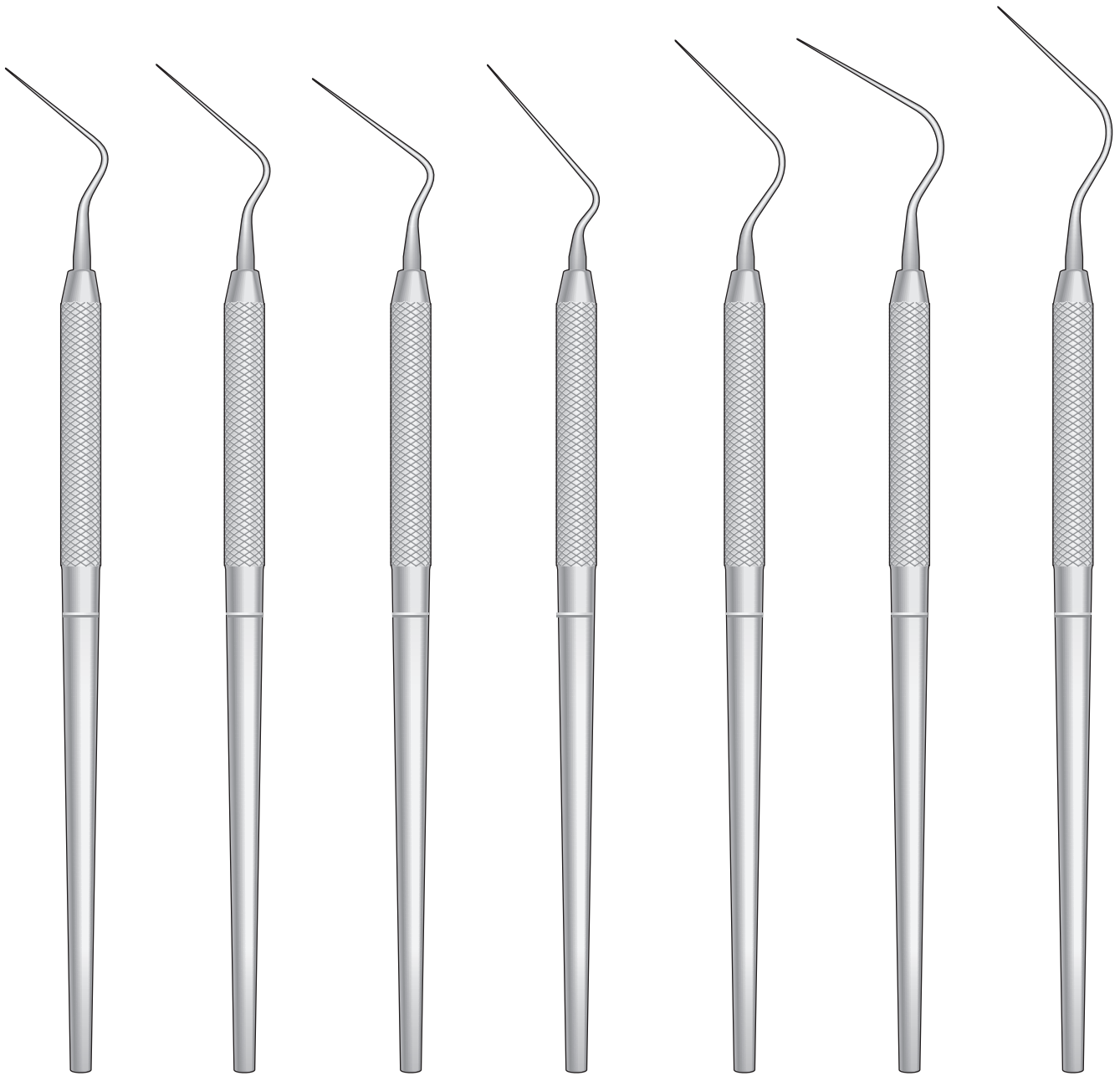

SP-1
Fig.1S

SP-2
Fig.2S

SP-3
Fig.D11

SP-4
Fig.MA57

SP-5
Fig.0

SP-6
Fig.00

SP-7
Fig.3



Watteträger
Cotton Applicators
Porta cotone
Porta algodones
Porte cotons

Tamponstopfer
Gauze Packers
Porta tamponi
Tamponeadores
Porte tampons

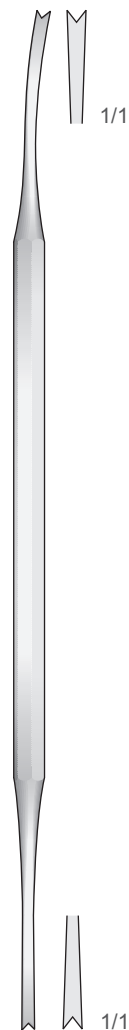

LUNIATSCHEK
PF-6
170 mm

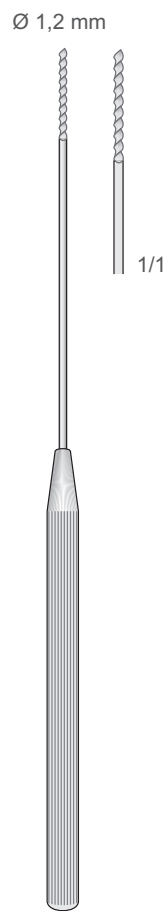

UNIVERSAL
PF-40
140 mm

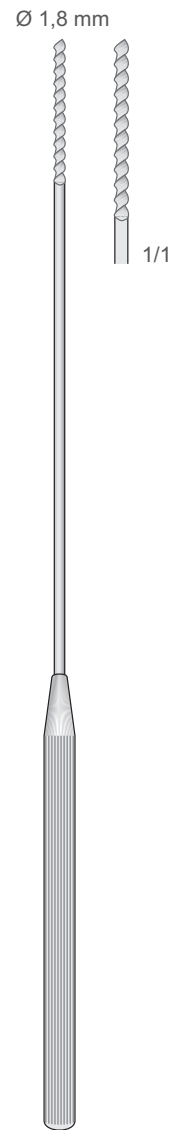

UNIVERSAL
PF-41
180 mm

Mundspiegel und Griffe
Mirrors and mirror handles
Specchietti e manici
Espejos y mango
Miroirs et manche



Pack. 12 pcs.

P-3	18 mm
P-4	22 mm
P-5	24 mm

Plan
Plane
Piano
Planos
Plans



Pack. 12 pcs.

RH-4	22 mm
RH-5	24 mm

Rhodiumspiegel
Rhodium Mirror
Specchietto rodato
Espejo de rodio
Miroir au rhodium



Pack. 12 pcs.

G-3	18 mm
G-4	22 mm
G-5	24 mm

Hohl-Vergrößernd
Concave with enlarging effect
Concavo con ingrandimento
Còncavo con efecto de aumento
Creux avec effect agrandissant



Pack. 6 pcs.

RH-14	22 mm
--------------	-------

MEGA DUO
RHODIUM n.4

Beidseitig Rhodium Beschichtet
Rhodium-coated, both sides
Con rivestimento in rodio su entrambi i lati
Ambos lados con revestimiento de rodio
Revêtu de rhodium des deux côtés



Massiv
Solid
Pieno
Sólido
Massif

Rostfrei
Stainless
Inox
Inoxidable
Inoxydable

MA-1
120 mm



Massiv
Solid
Pieno
Sólido
Massif

Rostfrei
Stainless
Inox
Inoxidable
Inoxydable

MA-2
125 mm



Hohl
Hollow
Vuoto
Hueco
Creux

Verchromt
Chromium
Cromato
Cromado
Chromé

MA-3
125 mm



Hohl
Hollow
Vuoto
Hueco
Creux

Aluminium
Alu
Alluminio
Alu
Alu

AL-MA5
120 mm



Hohl
Hollow
Vuoto
Hueco
Creux

Rostfrei
Stainless
Inox
Inoxidable
Inoxydable

MA-7
135 mm



1/1



1/1



1/1



Mundspiegel und Griffe
 Mirrors and mirror handles
 Specchietti e manici
 Espejos y mango
 Miroirs et manche

Spiegeldurchmesser - Diameter of mirrors
 Diametro dello specchio - Diamètre des miroirs
 Diámetro de los espejos

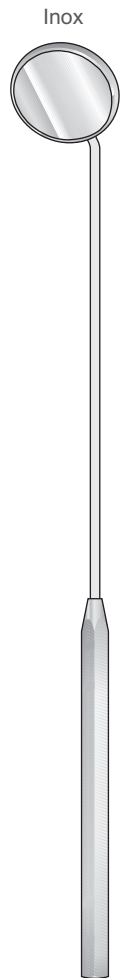
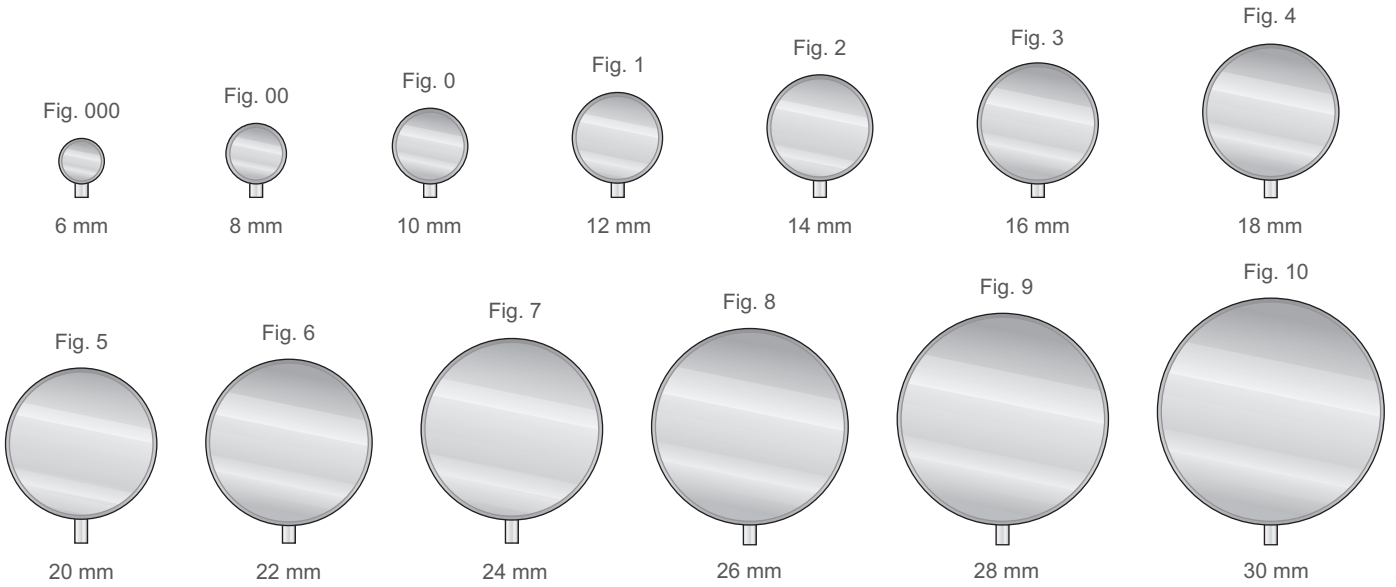

G-8/G-30
180 mm

Kehlkopfspiegel mit
 Sechskantgriff
 Laryngeal mirrors
 with hexagonal handle
 Specchietto laringeo
 con manico esagonale
 Espejo laringeo
 con mango hexagonal
 Miroirs laryngiens
 avec manche hexagonal

- G-8** Fig. 00
- G-10** Fig. 0
- G-12** Fig. 1
- G-14** Fig. 2
- G-16** Fig. 3
- G-18** Fig. 4
- G-20** Fig. 5
- G-22** Fig. 6
- G-24** Fig. 7
- G-26** Fig. 8
- G-28** Fig. 9
- G-30** Fig. 10

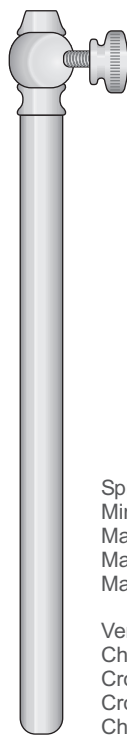

MA-6
120 mm

Spiegelgriff
 Mirrors handle
 Manico per specchietti
 Mango para espejos
 Manche à miroir

Verchromt
 Chromium
 Cromato
 Cromado
 Chromé

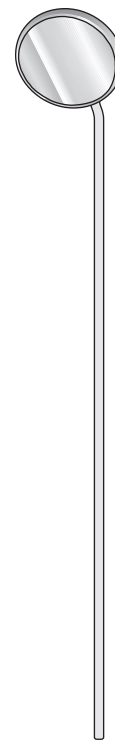

P-000/P-06
120 mm

Kehlkopfspiegel
 Laryngeal mirrors
 Specchietto laringeo
 Espejos laringeos
 Miroirs laryngiens

- P-000** Fig. 000
- P-00** Fig. 00
- P-0** Fig. 0
- P-01** Fig. 1
- P-02** Fig. 2
- P-03** Fig. 3
- P-04** Fig. 4
- P-05** Fig. 5
- P-06** Fig. 6



Spritzen zur lokalen Interligamentär-Anästhesie
Syringes for Intraligamental anaesthesia
Siringa per anestesia intraligamentare
Jeringa intraligamentaria para anestesia
Seringues pour anesthésies locales intraligementaires

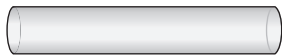
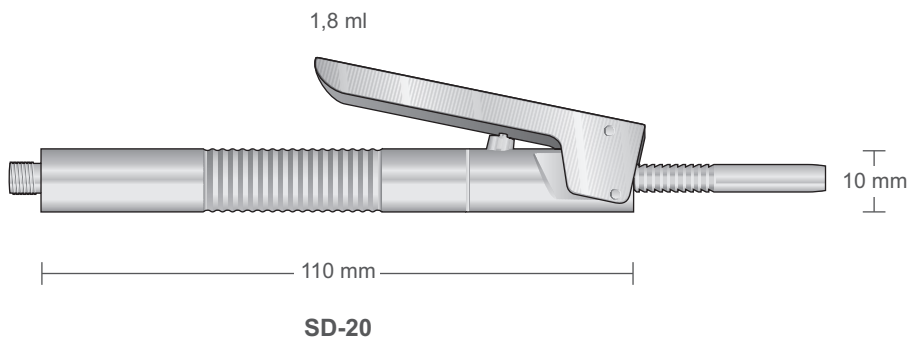

SD-7R
Ersatzzylinder für SD-7
Autoclavable plastic protection sleeve for SD-7
Protezione in plastica autoclavabile per SD-7
Cilindro de repuesto para SD-7
Cylindre de rechange pour SD-7

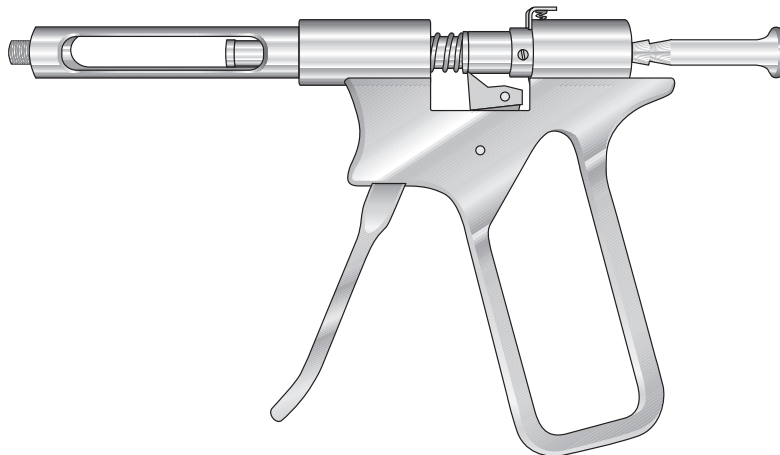

SD-7



Dental-Spritzen
Dental syringes
Siringhe dentali
Jeringas dentales
Seringues dentaires

Zylinder-Ampullen Spritzen
Cartridge Syringes
Siringhe per tubofiale
Jeringas de ampollas
Seringues d'ampoules

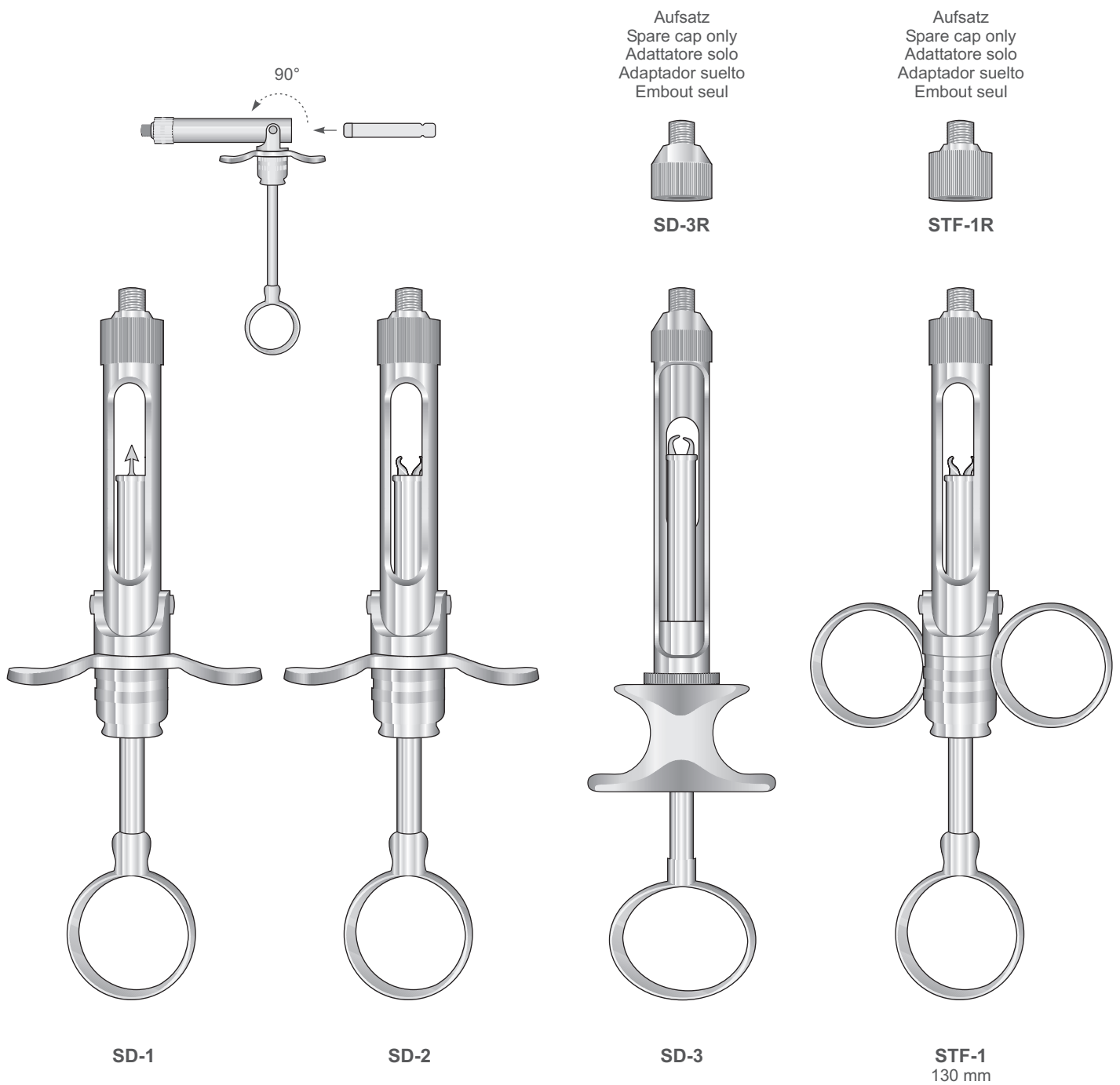

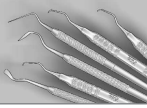

Küretten
Curettes
Curette
Curetas
Curettes



**GRACEY
CU-1/2**

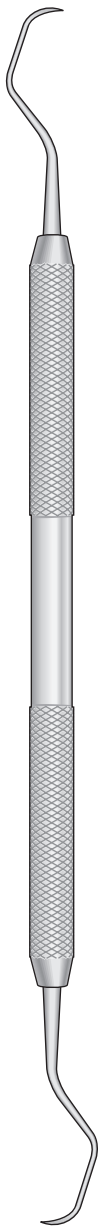

**GRACEY
CU-3/4**

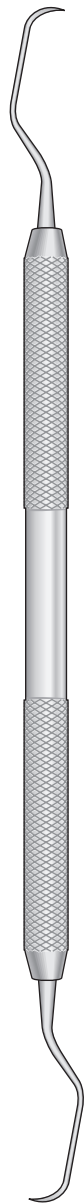

**GRACEY
CU-5/6**



**GRACEY
CU-7/8**

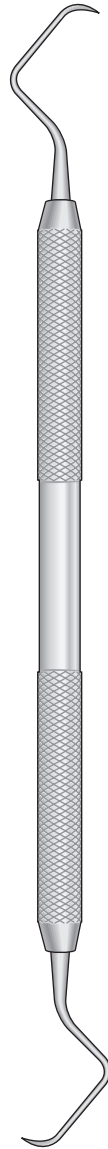

**GRACEY
CU-9/10**



**GRACEY
CU-11/12**

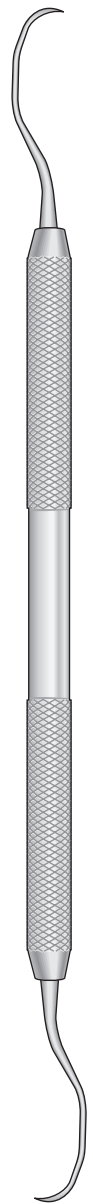

**GRACEY
CU-13/14**



Küretten
Curettes
Curette
Curetas
Curettes

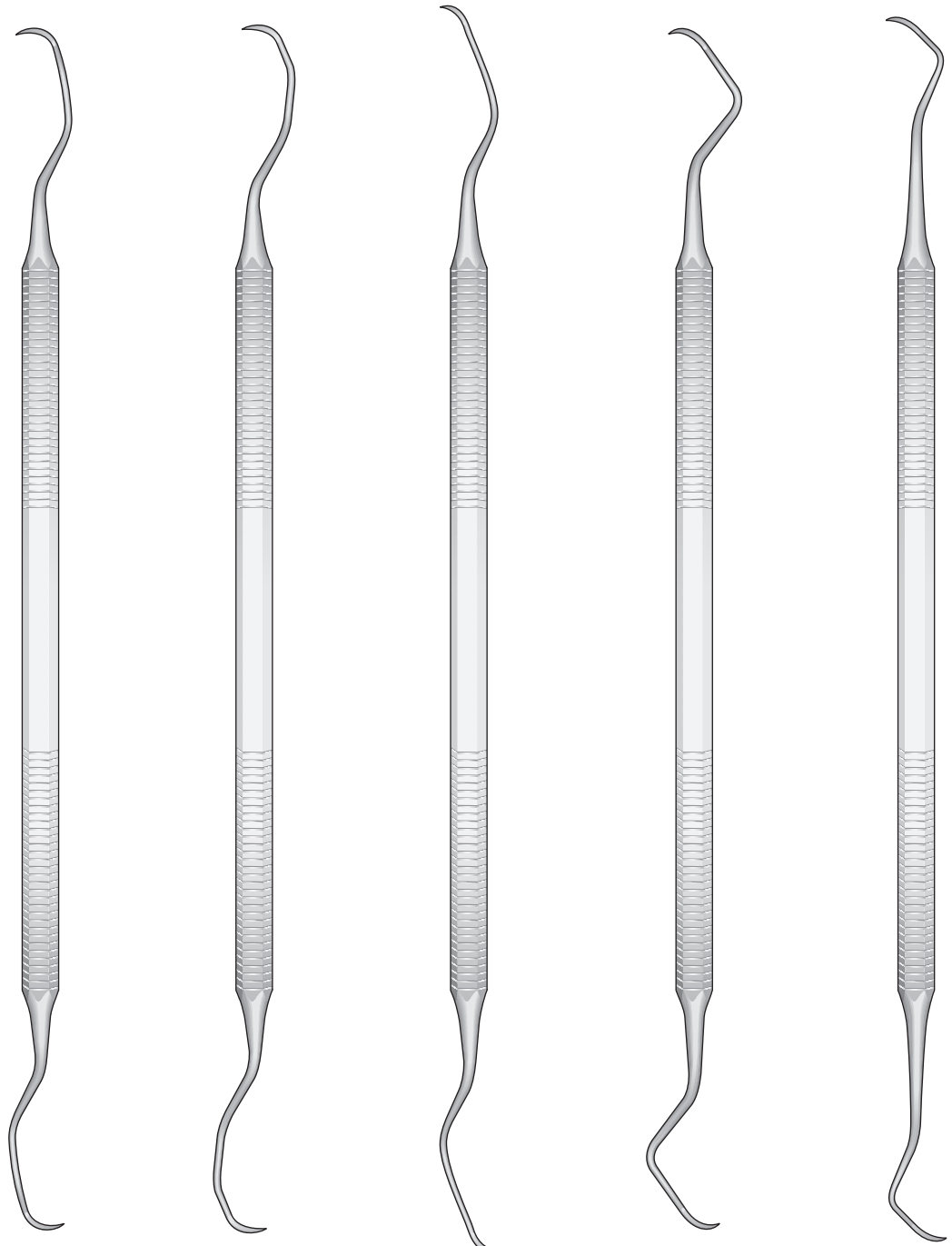

LANGER Fig.1/2
COL-1/2

LANGER Fig.3/4
COL-3/4

COLUMBIA
COL-2RL

COLUMBIA
COL-4RL

COLUMBIA
COL-13/14

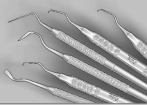

Küretten Elite by Bontempi
Curettes Elite by Bontempi
Curette Elite by Bontempi
Curetas Elite by Bontempi
Curettes Elite by Bontempi

Elite

American made, German approved
Elite Scalers and Curettes
precision at it's best

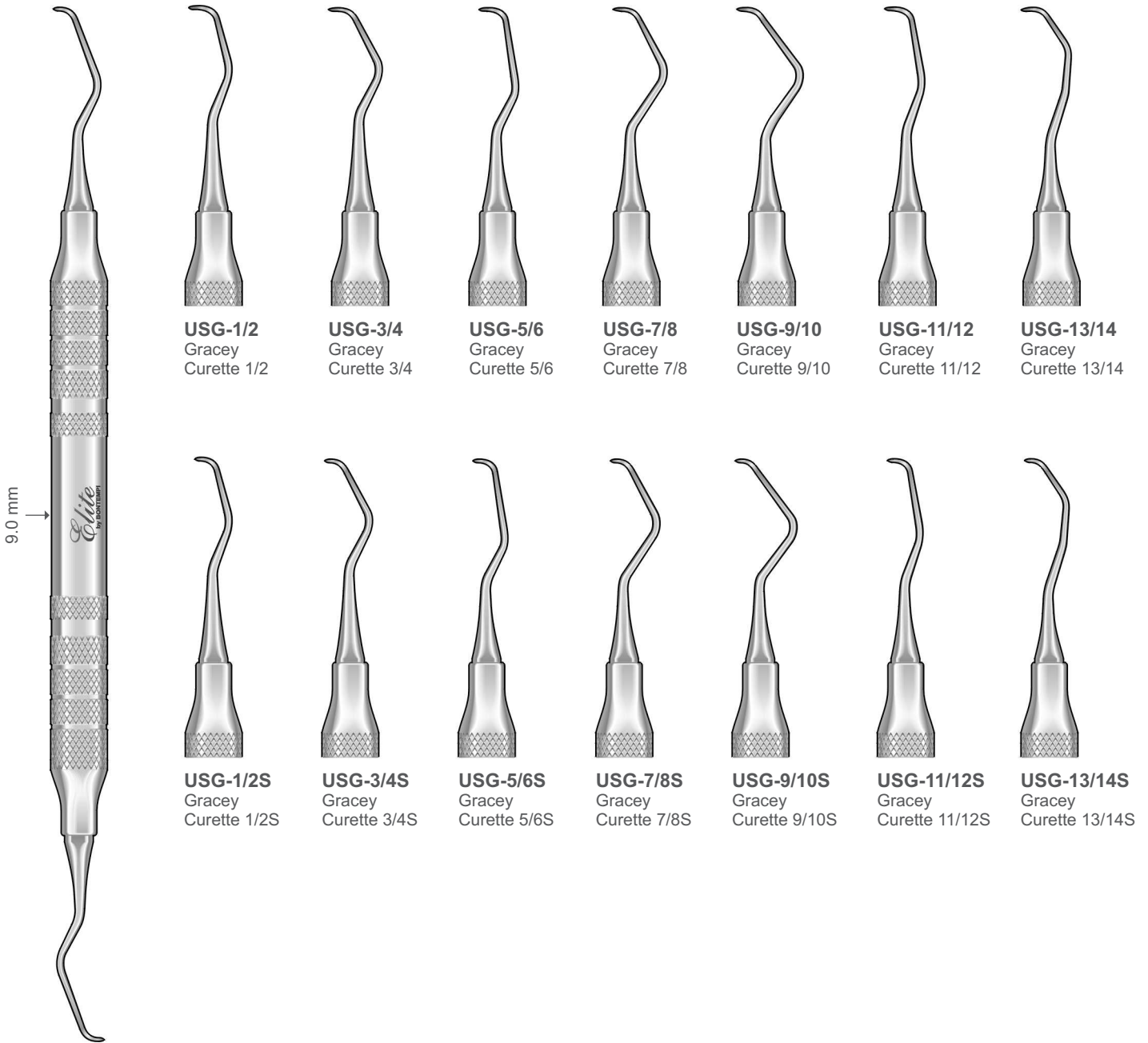

USG-1/2
Gracey
Curette 1/2

USG-3/4
Gracey
Curette 3/4

USG-5/6
Gracey
Curette 5/6

USG-7/8
Gracey
Curette 7/8

USG-9/10
Gracey
Curette 9/10

USG-11/12
Gracey
Curette 11/12

USG-13/14
Gracey
Curette 13/14

USG-1/2S
Gracey
Curette 1/2S

USG-3/4S
Gracey
Curette 3/4S

USG-5/6S
Gracey
Curette 5/6S

USG-7/8S
Gracey
Curette 7/8S

USG-9/10S
Gracey
Curette 9/10S

USG-11/12S
Gracey
Curette 11/12S

USG-13/14S
Gracey
Curette 13/14S

Elite Scalers and Curette

Feather weight Extra Light handles
Balance and equilibrated for great tactile working ability
USA Stainless Steel, anticorrosion
Maintains long sharp edges



Elite

American made, German approved
Elite Scalers and Curettes
precision at it's best

Küretten Elite by Bontempi
Curettes Elite by Bontempi
Curette Elite by Bontempi
Curetas Elite by Bontempi
Curettes Elite by Bontempi

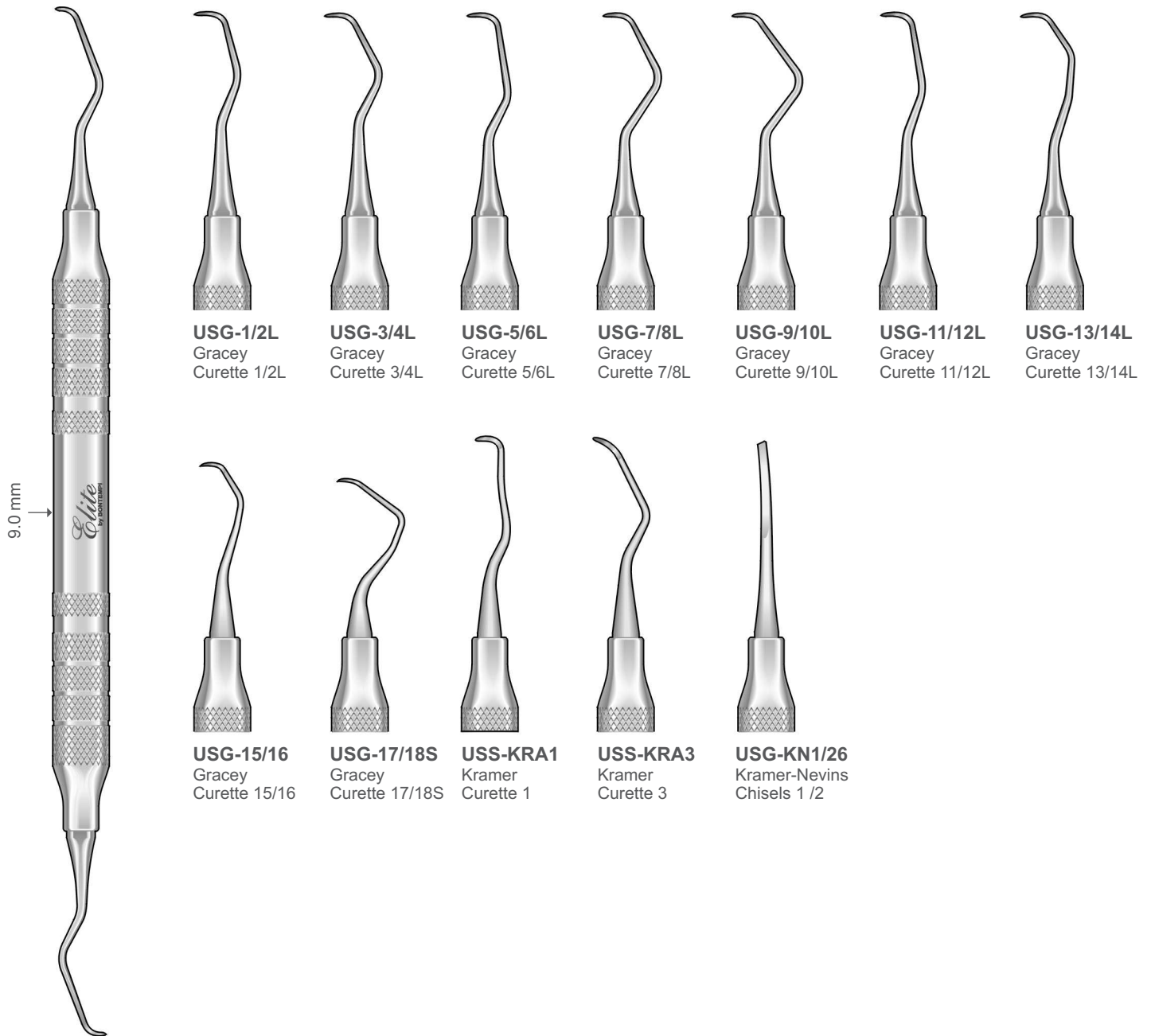

Elite Scalers and Curette

Feather weight Extra Light handles
Balance and equilibrated for great tactile working ability
USA Stainless Steel, anticorrosion
Maintains long sharp edges

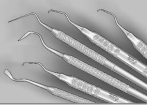

Küretten Elite by Bontempi
Curettes Elite by Bontempi
Curette Elite by Bontempi
Curetas Elite by Bontempi
Curettes Elite by Bontempi

Elite

American made, German approved
Elite Scalers and Curettes
precision at it's best

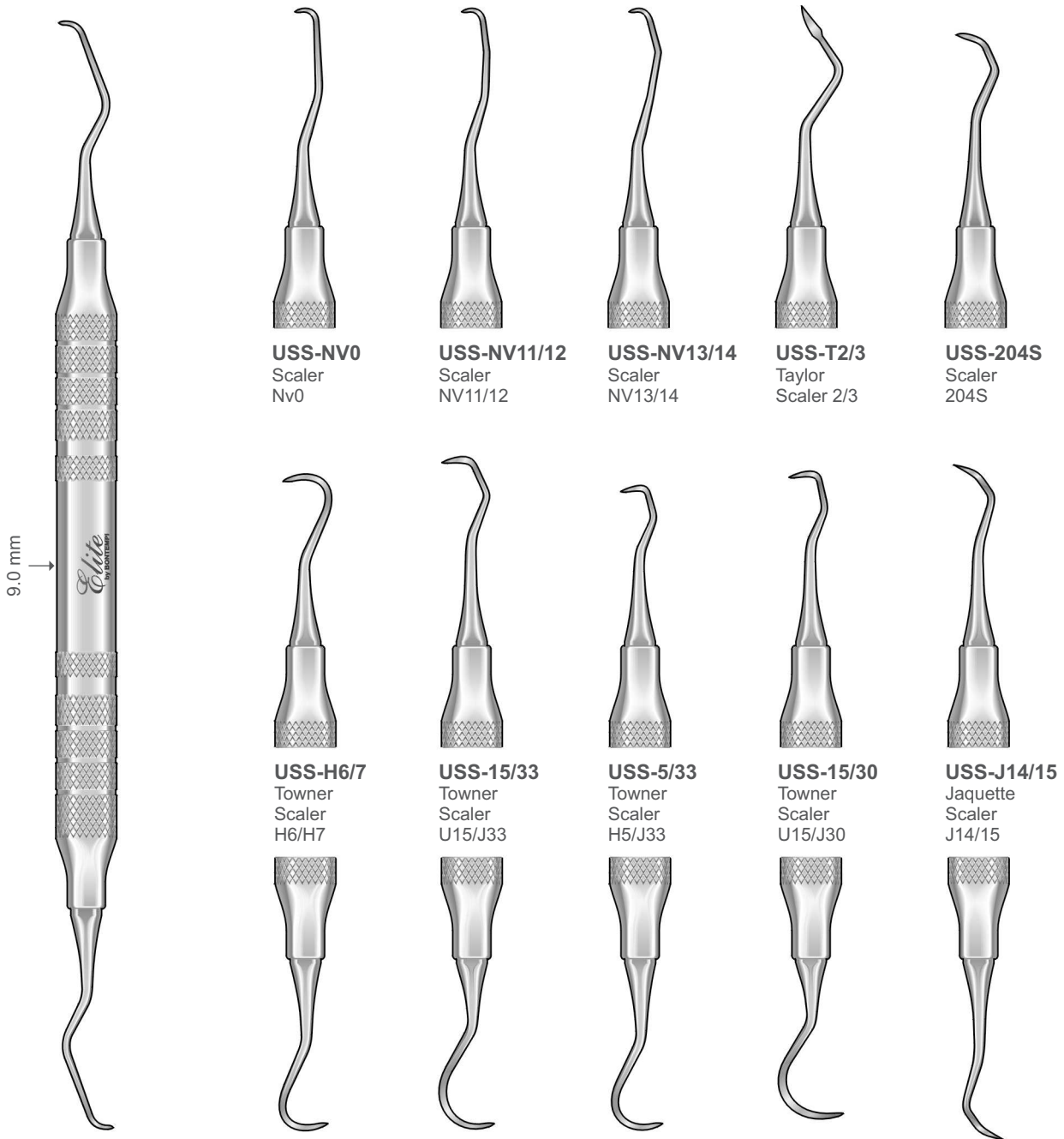

Elite Scalers and Curette

Feather weight Extra Light handles
Balance and equilibrated for great tactile working ability
USA Stainless Steel, anticorrosion
Maintains long sharp edges



Elite

American made, German approved
Elite Scalers and Curettes
precision at it's best

Küretten Elite by Bontempi
Curettes Elite by Bontempi
Curette Elite by Bontempi
Curetas Elite by Bontempi
Curettes Elite by Bontempi

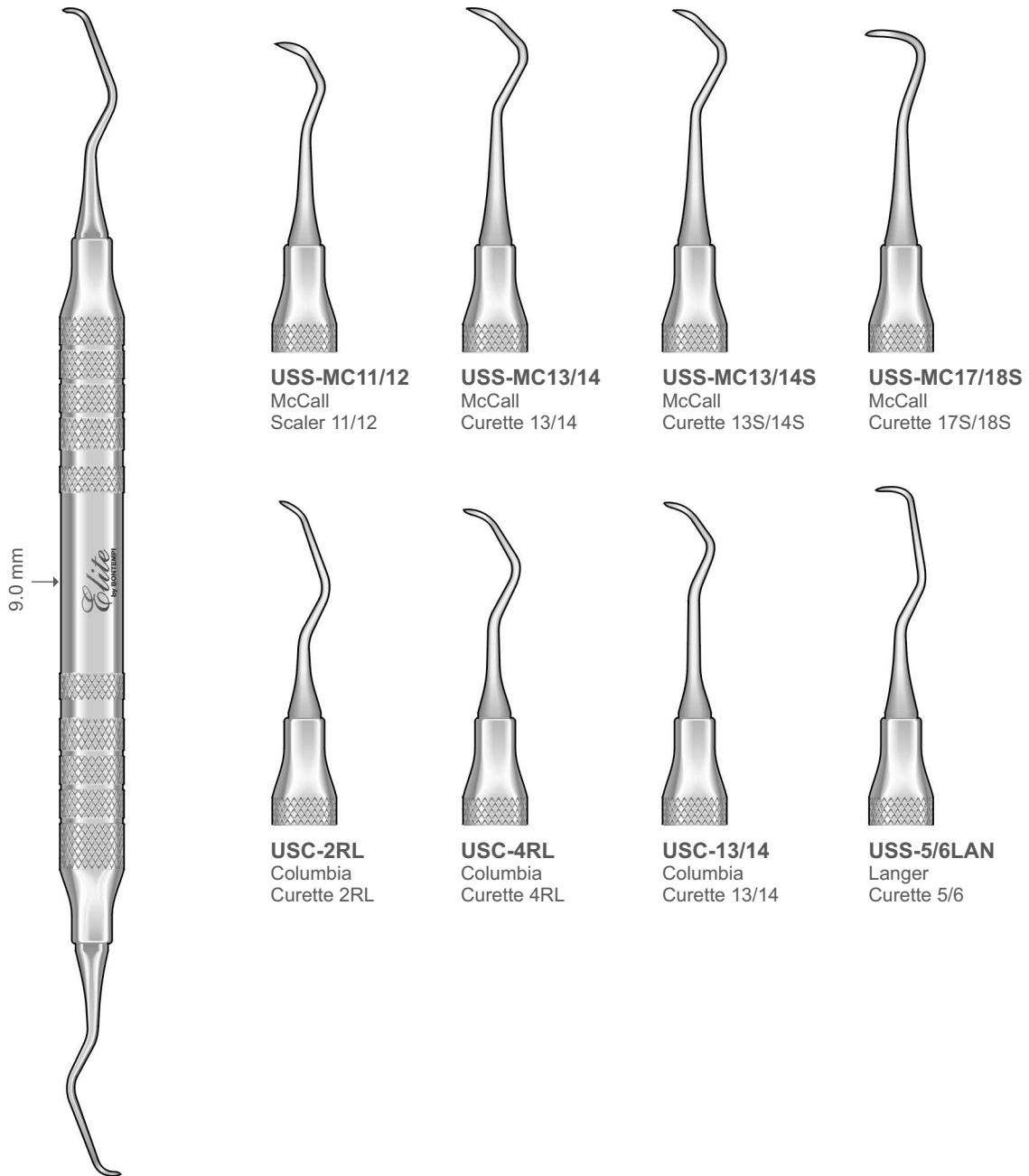

Elite Scalers and Curette

Feather weight Extra Light handles
Balance and equilibrated for great tactile working ability
USA Stainless Steel, anticorrosion
Maintains long sharp edges

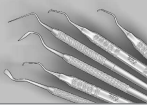

Küretten - Feilen
Curettes - Files
Curette - Lime
Curetasc - Lima
Curettes - Limes

Universal Küretten
Universal Curettes
Curette universali
Curetas universales
Curettes universelles

Parodontalfeilen
Periodontal Files
Lime parodontali
Limas parodontales
Limes parodontales

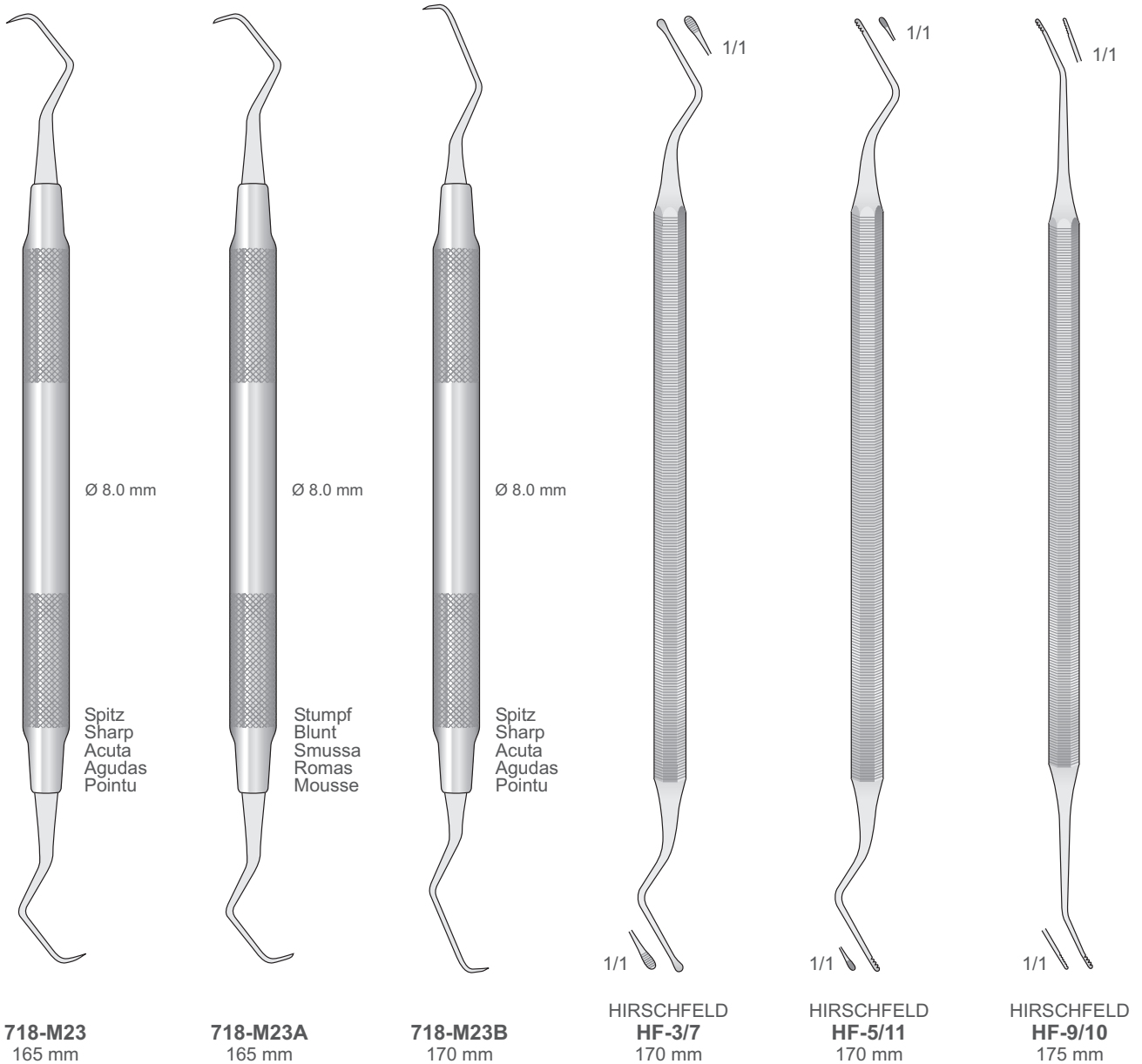



Scaler
Scalers
Ablatori di tartaro
Limpiadores
Détartreurs

Scalers

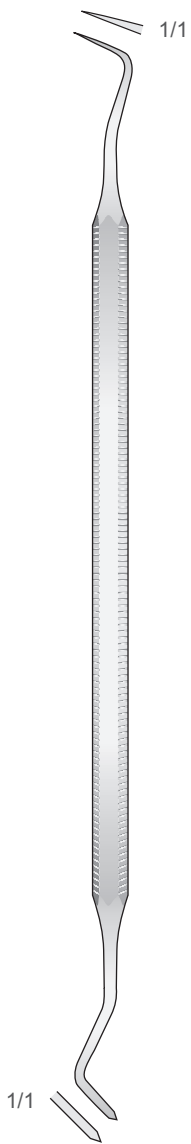

**LANGE
PF-9**
160 mm

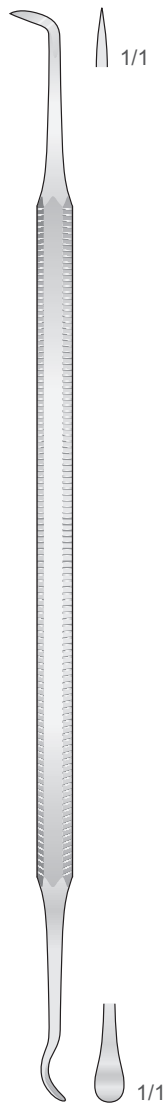

**MITCHEL
AT-12**
170 mm



AT-1



AT-2R



AT-2L



AT-6

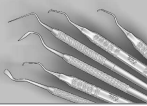

Amalgampistole für retrograde
Amalgam gun for retrograde
Siringhe portamalgame retrogradi
Portaamalgama para retrógradas
Porte-amalgame pour rétrogrades

Nach oben Gebogen - Curved up
Curva in avanti - Curvas hacia arriba
Courbes vers le haut
Ø 0,9 mm

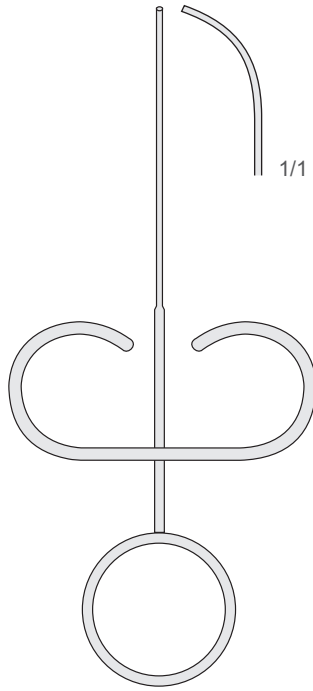

SS-51
130 mm

Seitwärts Gebogen - Curved to side
Curva sul lato - Curvas laterales
Courbes latérales
Ø 0,9 mm

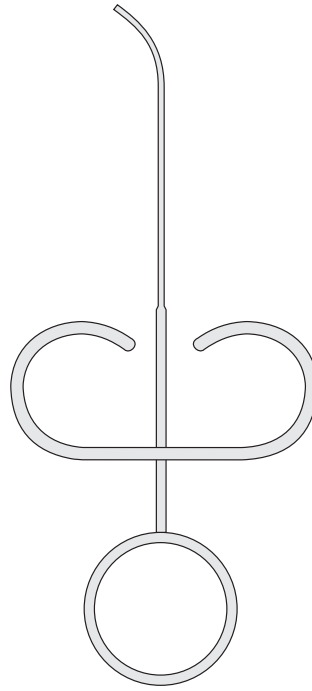

SS-55
130 mm

Gerade - Straight
Diritta - Rectas
Droites
Ø 1,2 mm

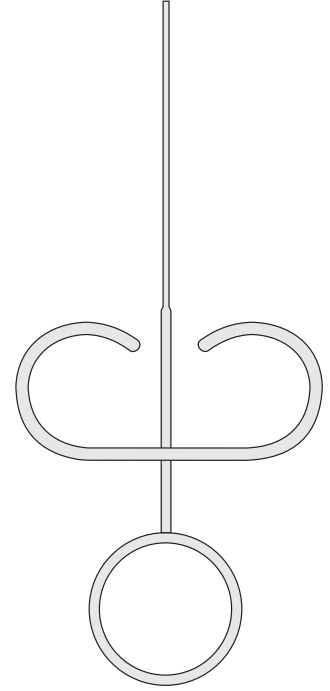

SS-54
130 mm

Seitwärts Gebogen - Curved to side
Curva sul lato - Curvas laterales
Courbes latérales
Ø 1,2 mm

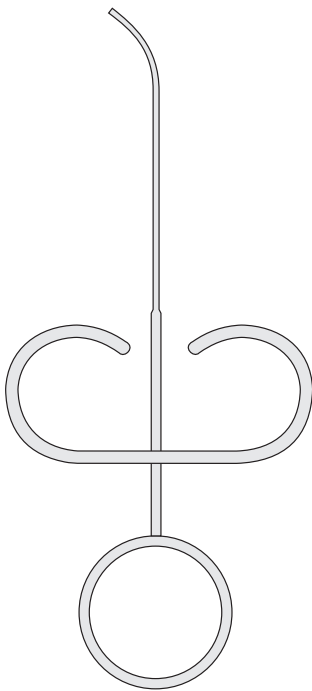

SS-56
130 mm

Nach oben Gebogen - Curved up
Curva in avanti - Curvas hacia arriba
Courbes vers le haut
Ø 1,2 mm

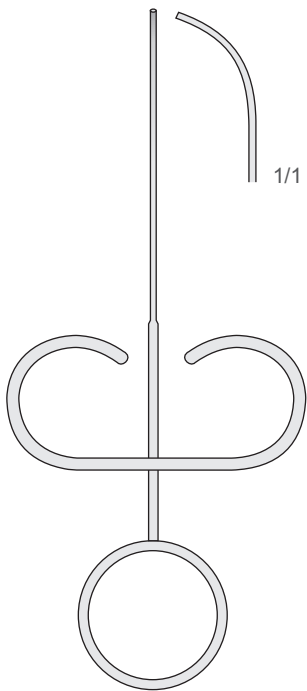

SS-58
130 mm

Seitwärts Gebogen - Curved to side
Curva sul lato - Curvas laterales
Courbes latérales
Ø 1,8 mm

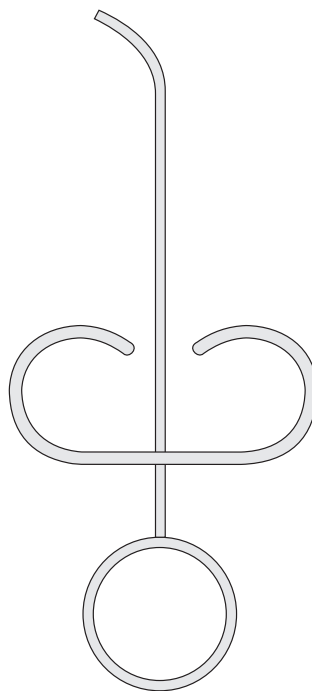

SS-50
130 mm

Nach oben Gebogen - Curved up
Curva in avanti - Curvas hacia arriba
Courbes vers le haut
Ø 1,8 mm

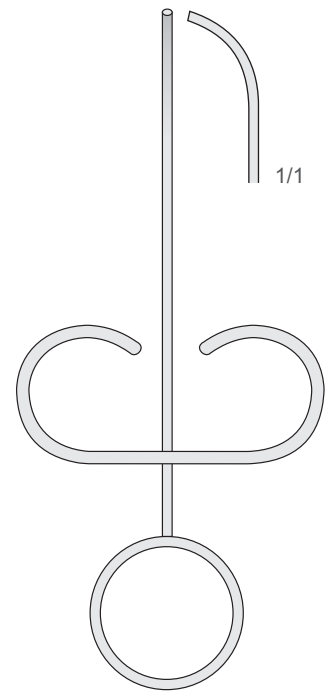

SS-52
130 mm



Amalgamträger
Amalgam Carriers
Porta amalgama
Porta-amalgamas
Porte-amalgames

Amalgambecher
Amalgam well
Mortaino per amalgama
Vaso para amalgama
Gobelet pour amalgame



Rostfrei
Stainless Steel
Acciaio inossidabile
Acero inoxidable
Acier Inoxydable

SS-65
Ø 35 mm
h. 35 mm

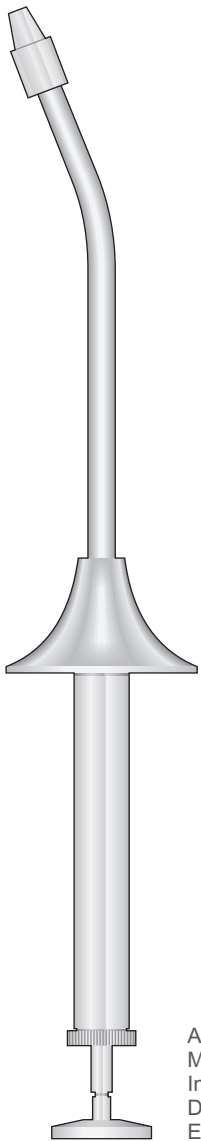

Aus Metall
Metal tip
In metallo
De metal
En métal

SS-15

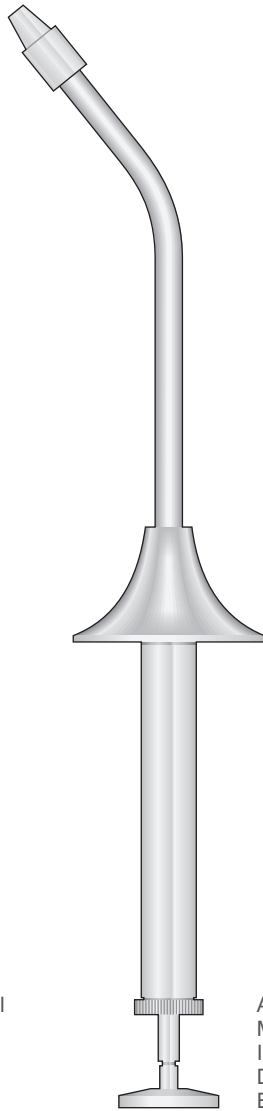

Aus Metall
Metal tip
In metallo
De metal
En métal

SS-16

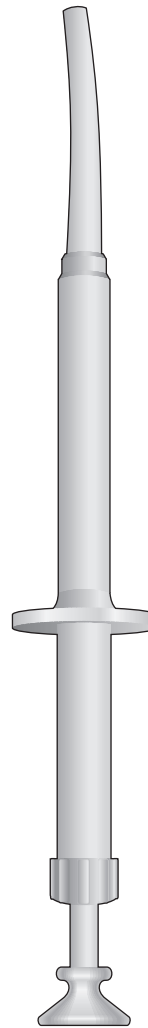

Autoclavable
Aus Kunststoff
Plastic tip
In plastica
De plàstic
En plastique

SS-41
170 mm

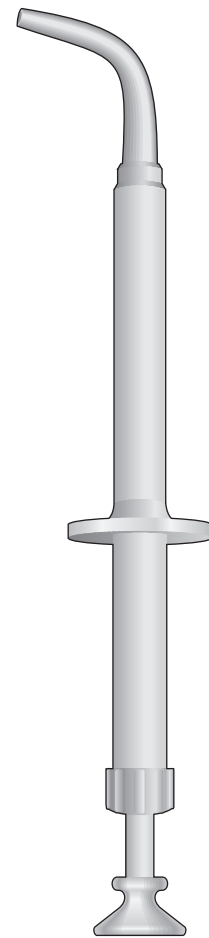

Autoclavable
Aus Kunststoff
Plastic tip
In plastica
De plàstic
En plastique

SS-42
160 mm

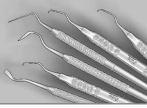

Kompositinstrumente
Composite Instruments
Strumenti per composito
Instrumentos para composites
Instruments pour composites

Titanbeschichtet
Titanium-coated
Ricoperto in Titanio
Con revestimiento de titanio
Recouvert de Titane

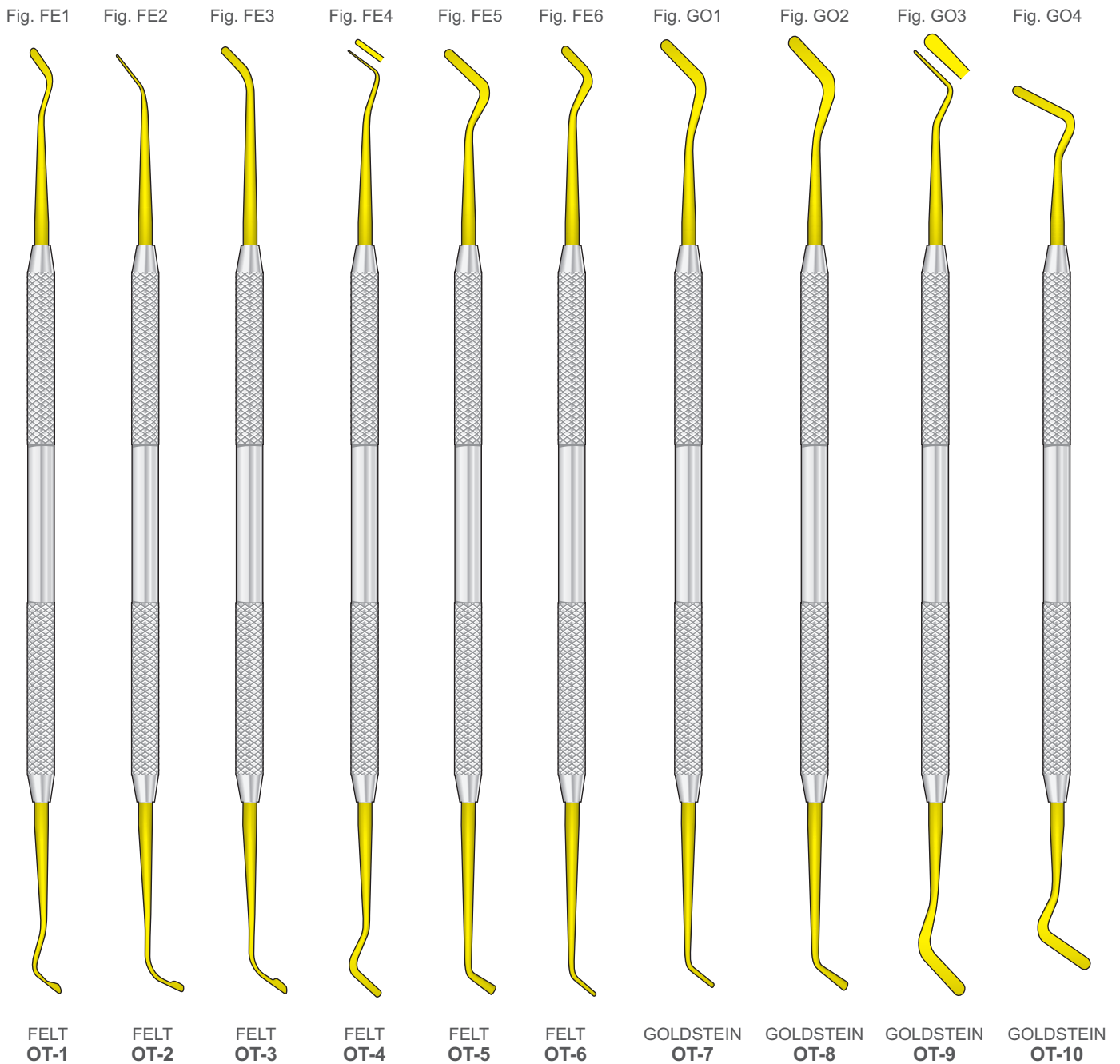



Kompositinstrumente
Composite Instruments
Strumenti per composito
Instrumentos para composites
Instruments pour composites

Titanbeschichtet
Titanium-coated
Ricoperto in Titanio
Con revestimiento de titanio
Recouvert de Titane

Fig. CP1
1,5 mm



OT-11

Fig. CP2
2,0 mm



OT-12

Fig. CP3
2,0 mm



OT-13

Fig. CP4
2,5 mm



OT-14

Fig. CP5



OT-15

Fig. CP6



OT-16

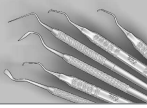

Kompositinstrumente
Composite Instruments
Strumenti per composito
Instrumentos para composites
Instruments pour composites

Alu
Aluminium
Alluminio
Aluminio
Aluminium

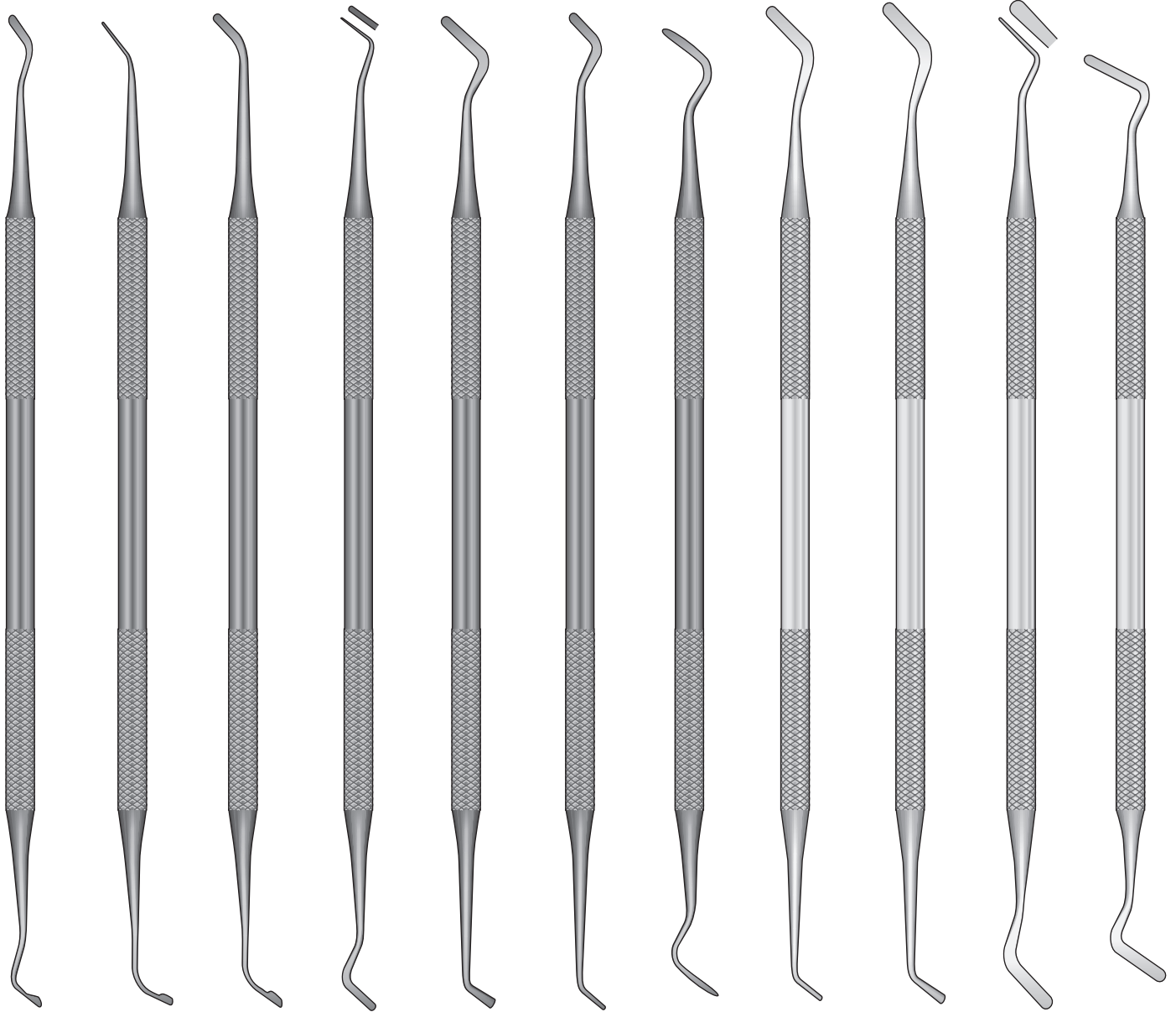

FELT FE-1 **FELT FE-2** **FELT FE-3** **FELT FE-4** **FELT FE-5** **FELT FE-6** **FELT FE-4/5** **GOLDSTEIN GO-1** **GOLDSTEIN GO-2** **GOLDSTEIN GO-3** **GOLDSTEIN GO-4**



Zementspatel
Cement Spatulas
Spátule per cemento
Espátulas para cemento
Spatules à ciment

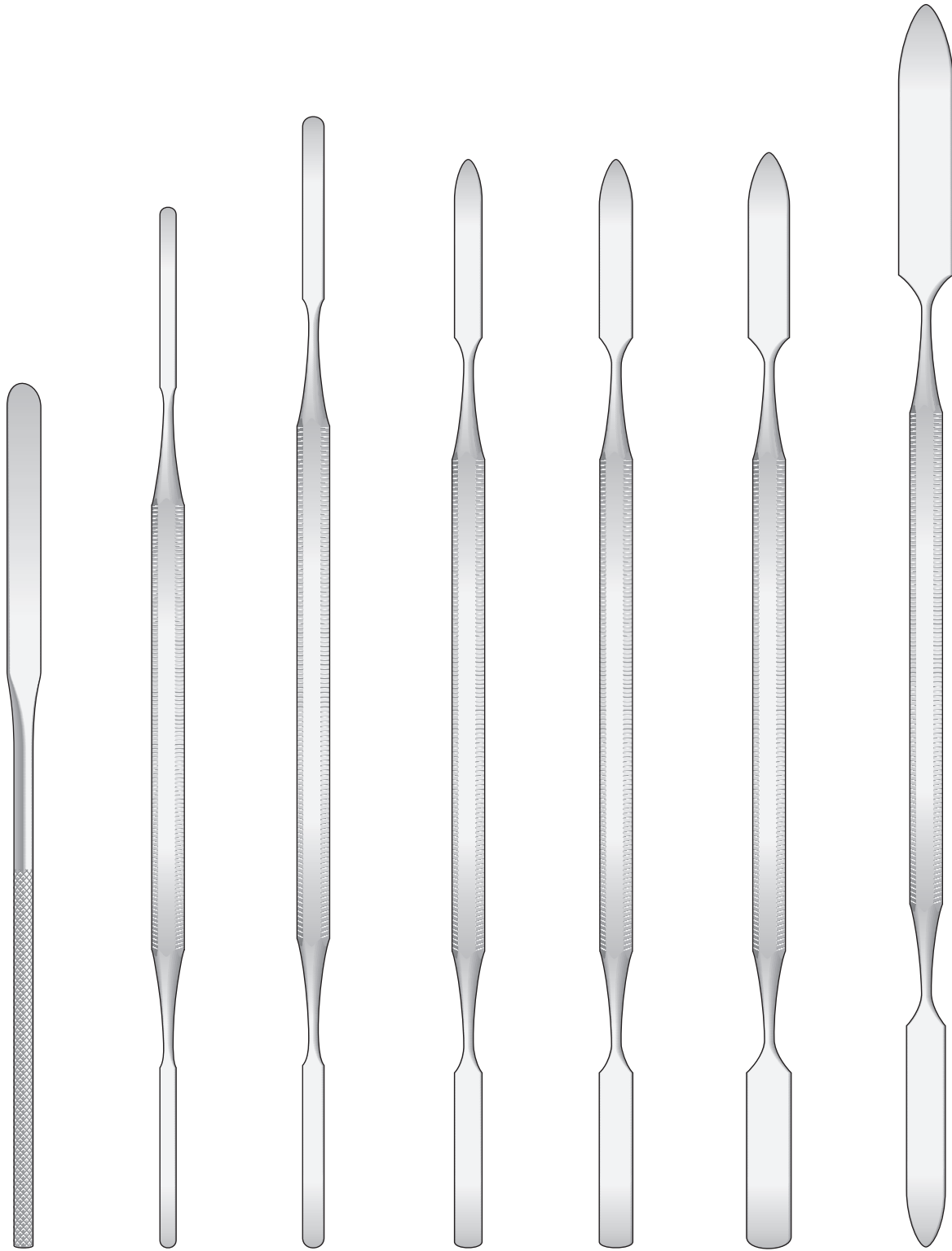

SR

S-00

S-0

S-1

S-2

S-3

S-4

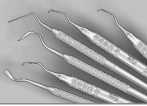

Heidemann-Spateln
Heidemann Spatulas
Spatole Heidemann
Espátulas Heidemann
Spatules Heidemann

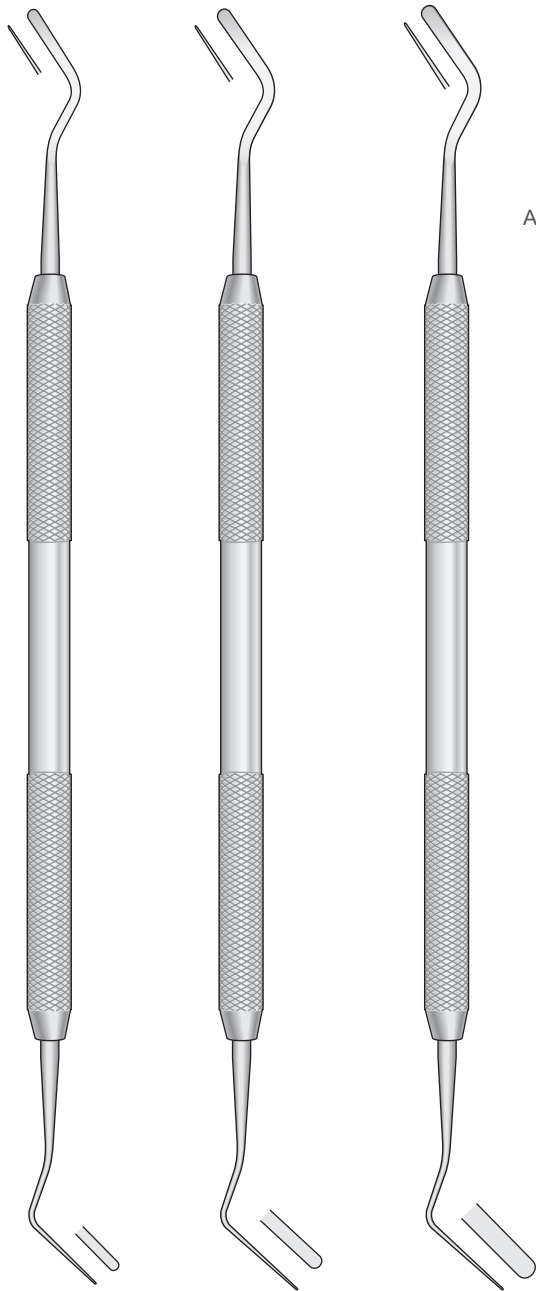

H-1
Fig. 1

H-2
Fig. 2

H-3
Fig. 3

A-1

Instrumente zum modellieren von Füllungen
Amalgam Carvers

Strumenti per modellare e rifinire otturazioni
Instrumentos para modelar las obturaciones
Instruments à modeler les obturations

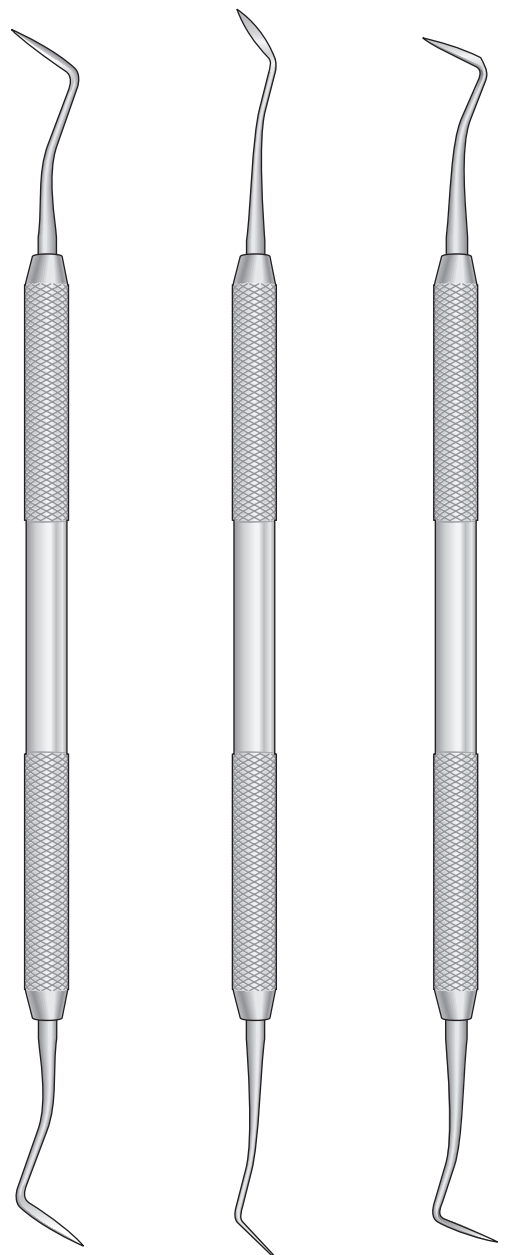

R-1

R-2

R-3



Instrumente zum Modellieren von Füllungen
 Amalgam carvers
 Strumenti per modellare e rifinire otturazioni
 Instrumentos para modelar las obturaciones
 Instruments à modeler les obturations

Instrument für Drahrückzug
 Instrument for Retractor wire
 Strumento per filo retrattore
 Instrumento para hilo retractor
 Instruments pour fil rétracteur

Cleoids - Discoids

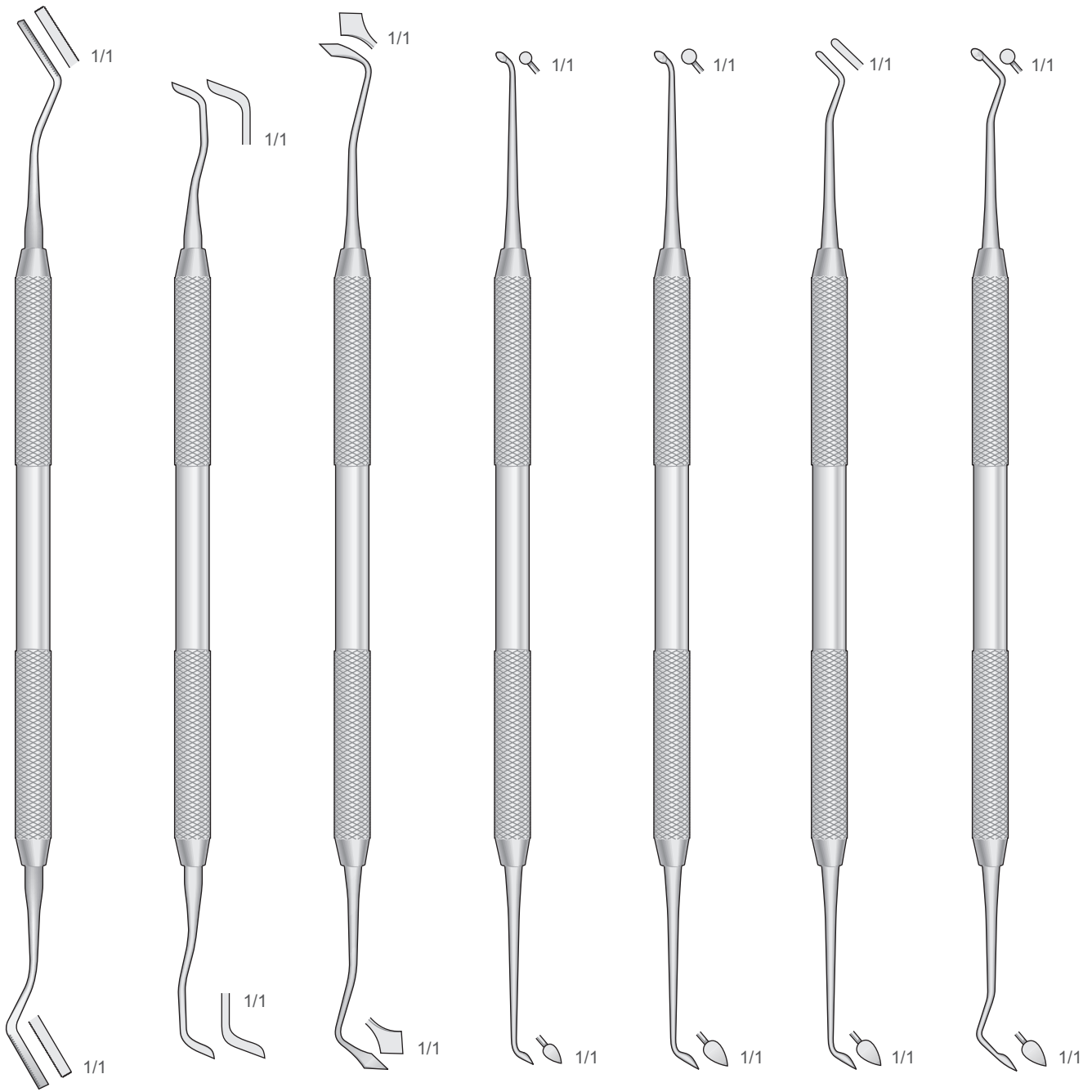

CV-11

USC-2
USC

F-2/3
FRAHM

CD-1
Fig. 1/2

CD-2
Fig. 4/5

CD-3
Fig. W.A.C.D.

CD-4
Fig. 3/6

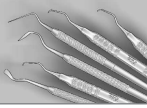

Füllungsinstrumente
Filling Instruments
Strumenti per otturazione
Instrumentos para obturaciones
Instruments pour obturations

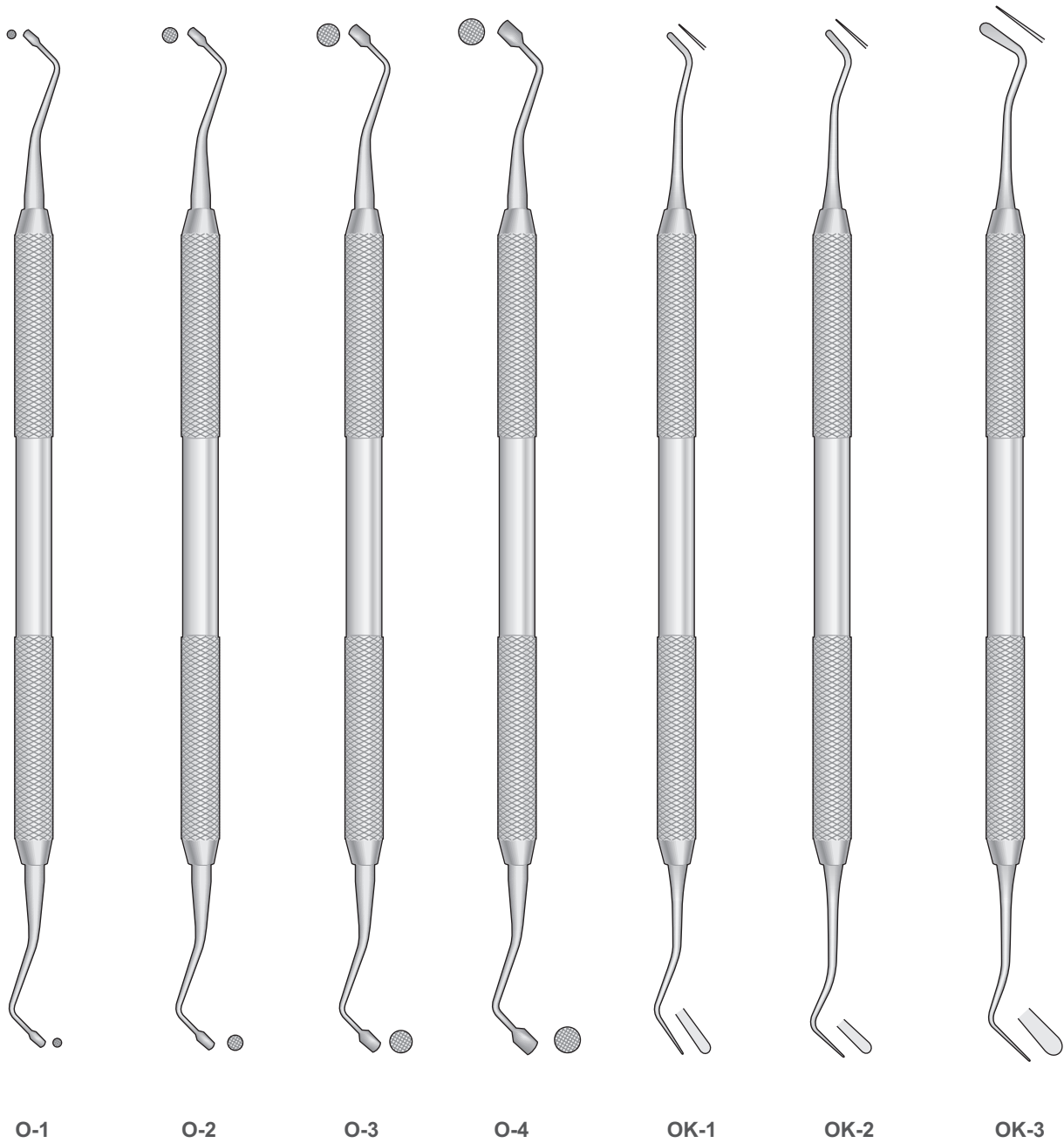



Füllungsinstrumente
Filling Instruments
Strumenti per obturazione
Instrumentos para obturaciones
Instruments pour obturations

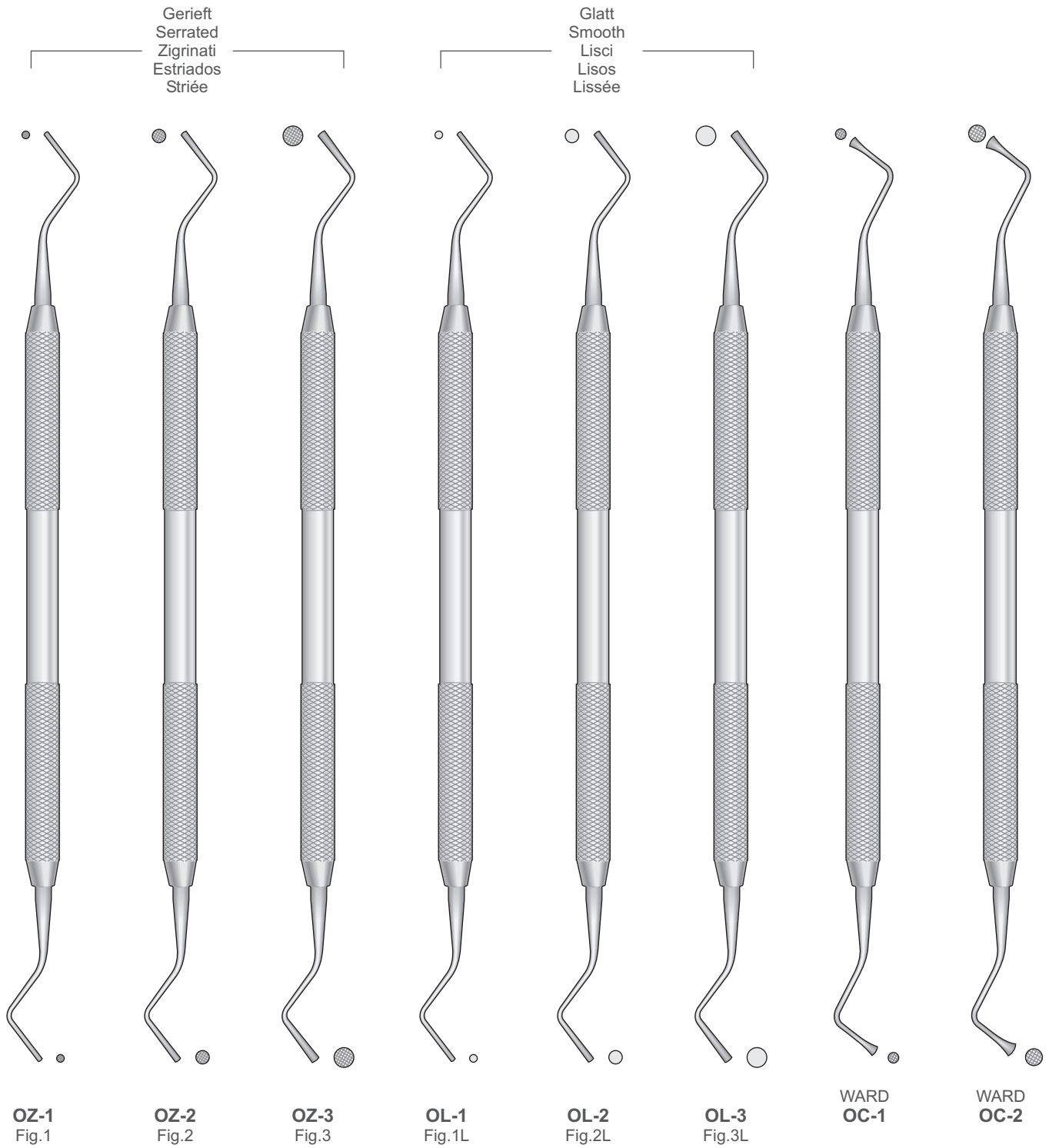

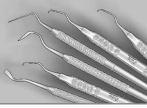

Füllungsinstrumente
Filling Instruments
Strumenti per otturazione
Instrumentos para obturaciones
Instruments pour obturations

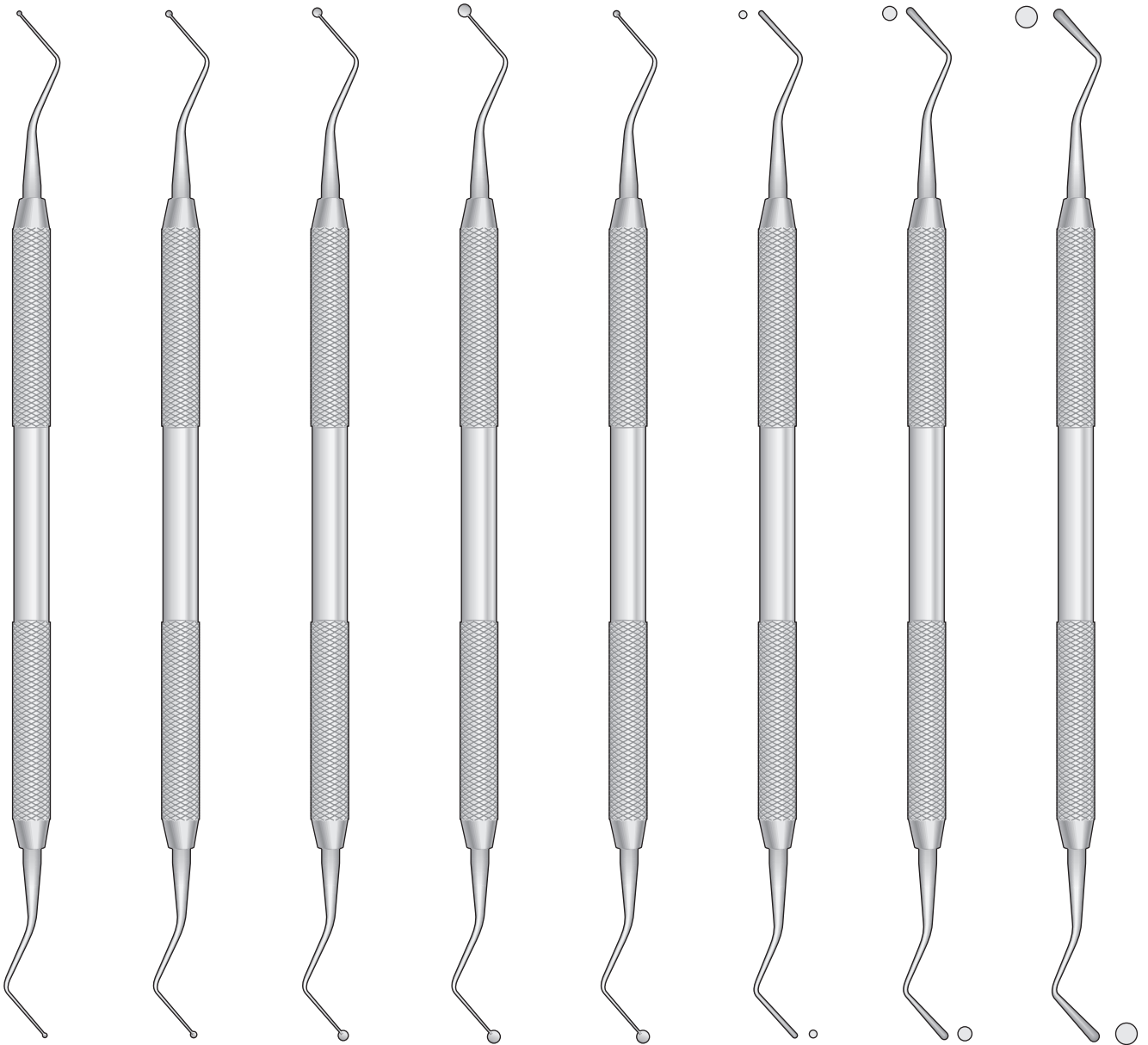

OP-1
Fig.1

OP-2
Fig.2

OP-3
Fig.3

OP-4
Fig.4

OP-5
Fig.5

OA-1
Fig.1

OA-2
Fig.2

OA-3
Fig.3



Füllungsinstrumente
Filling Instruments
Strumenti per otturazione
Instrumentos para obturaciones
Instruments pour obturations

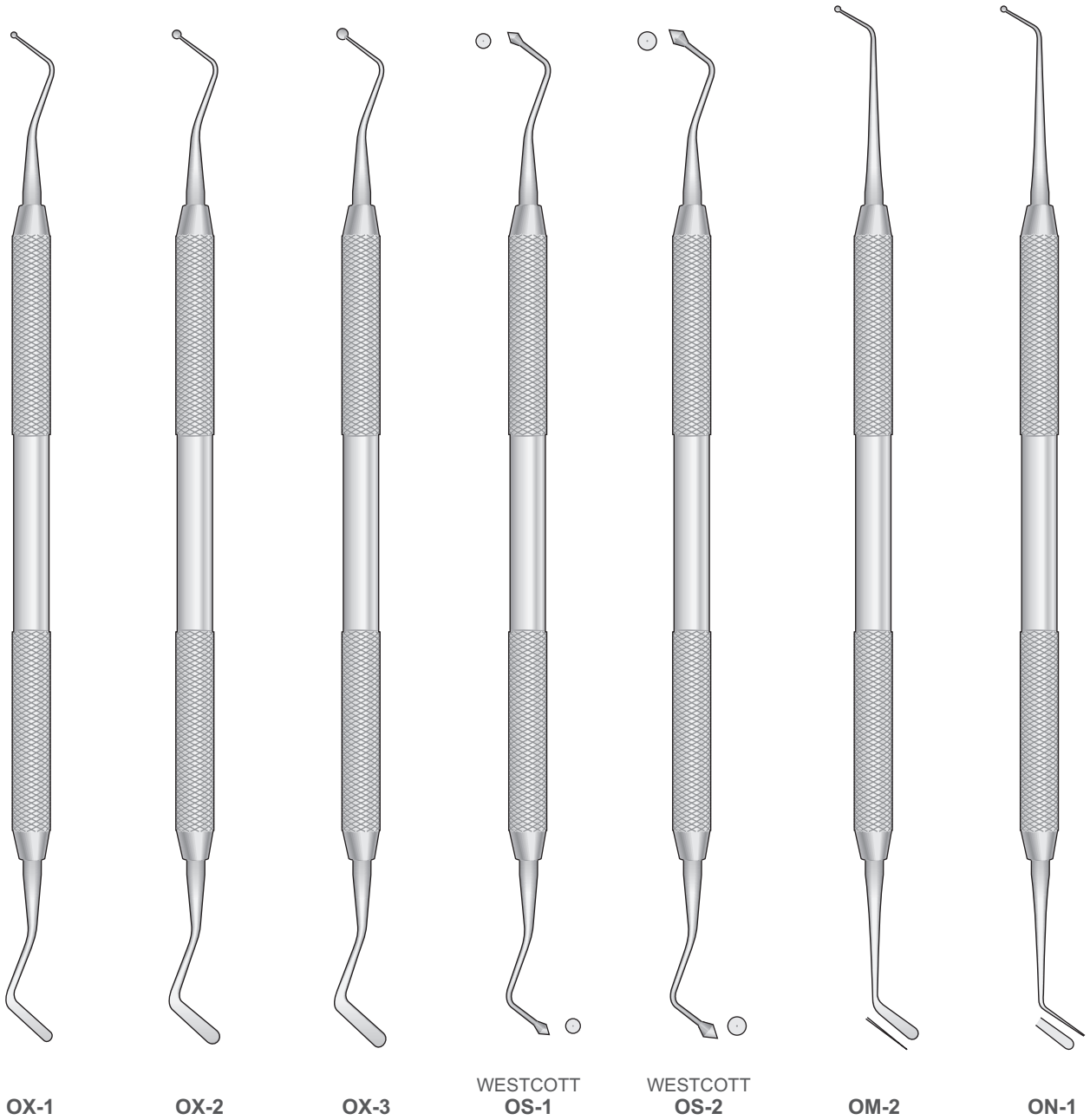

OX-1

OX-2

OX-3

**WESTCOTT
OS-1**

**WESTCOTT
OS-2**

OM-2

ON-1

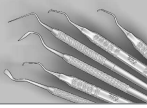

Füllungsinstrumente
Filling Instruments
Strumenti per otturazione
Instrumentos para obturaciones
Instruments pour obturations



**WHITE
B-3**
n°28

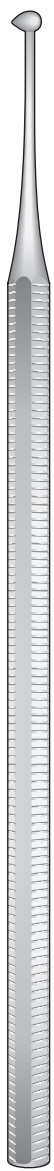

**WHITE
B-4**
n°29

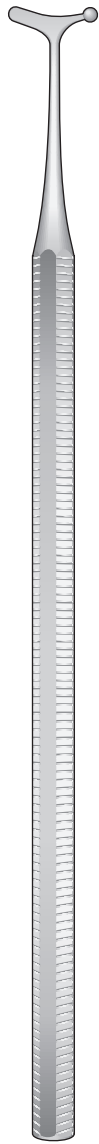

**WHITE
B-32**
n°32

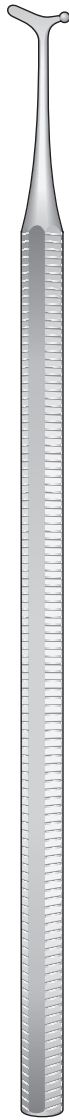

**WHITE
B-33**
n°33

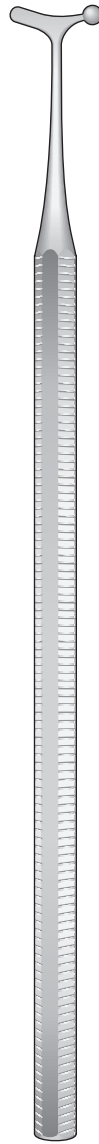

**WHITE
B-34**
n°34



**WHITE
B-28/29**
Doppio

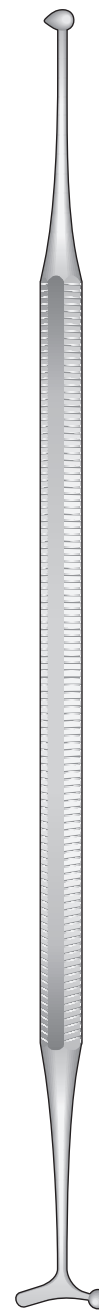

**WHITE
B-31/32**
Doppio

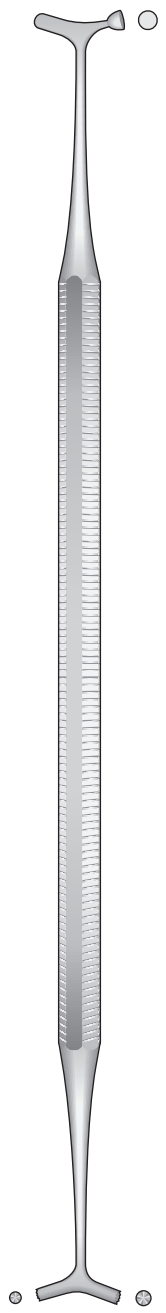

**BENNET
B-35**
170 mm



MARKLEY PLUGGERS

Amalgam Instrumente
Amalgam Instruments
Strumenti per amalgama
Instrumentos para amalgama
Instruments à amalgame



PM-1
Fig.1



PM-2
Fig.2

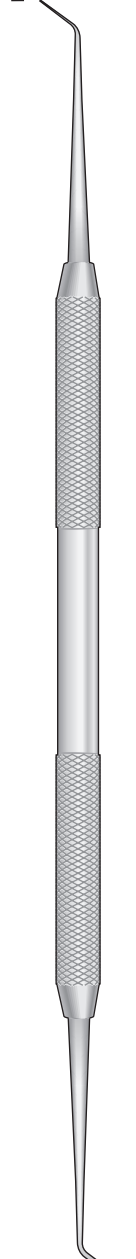

PM-3
Fig.3



PM-4
Fig.4

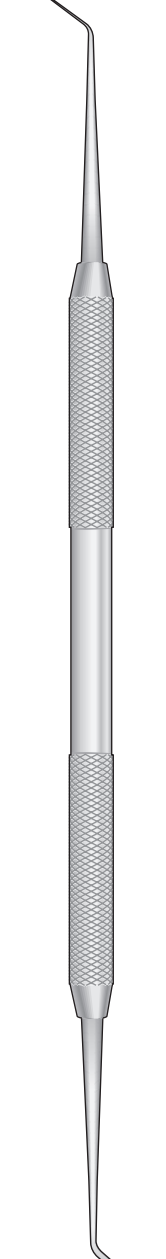

PM-5
Fig.5



PM-6
Fig.6

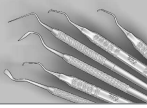

Schmelzinstrumente
Enamel Instruments
Strumenti da smalto
Instrumentos para esmalte
Instruments à émail

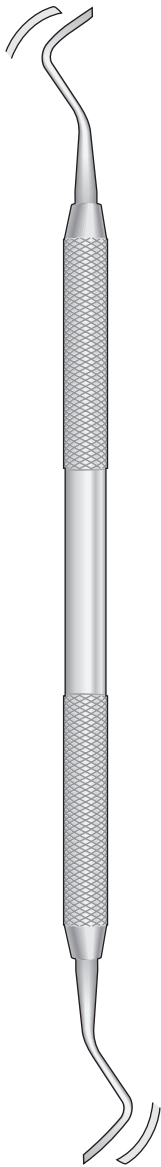

**BLACK
TS-1**
Fig.26

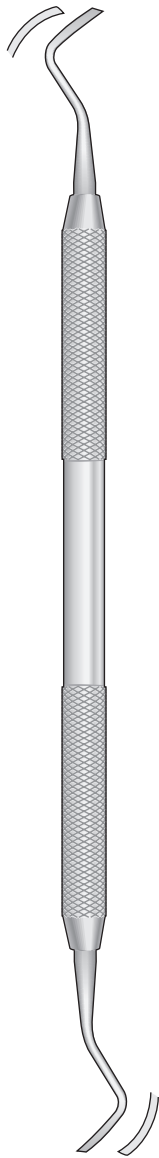

**BLACK
TS-2**
Fig.27

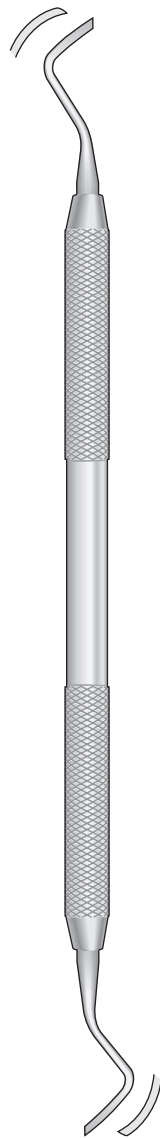

**BLACK
TS-3**
Fig.28

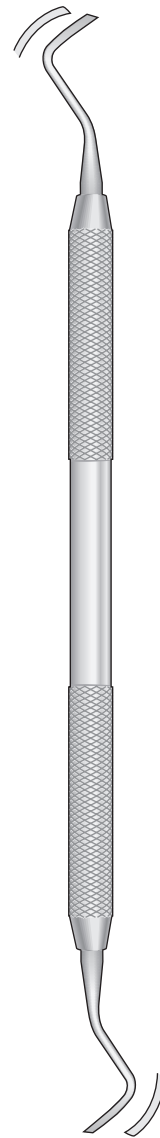

**BLACK
TS-4**
Fig.29



Excavatoren
Excavators
Escavatori
Excavadores
Excavateurs

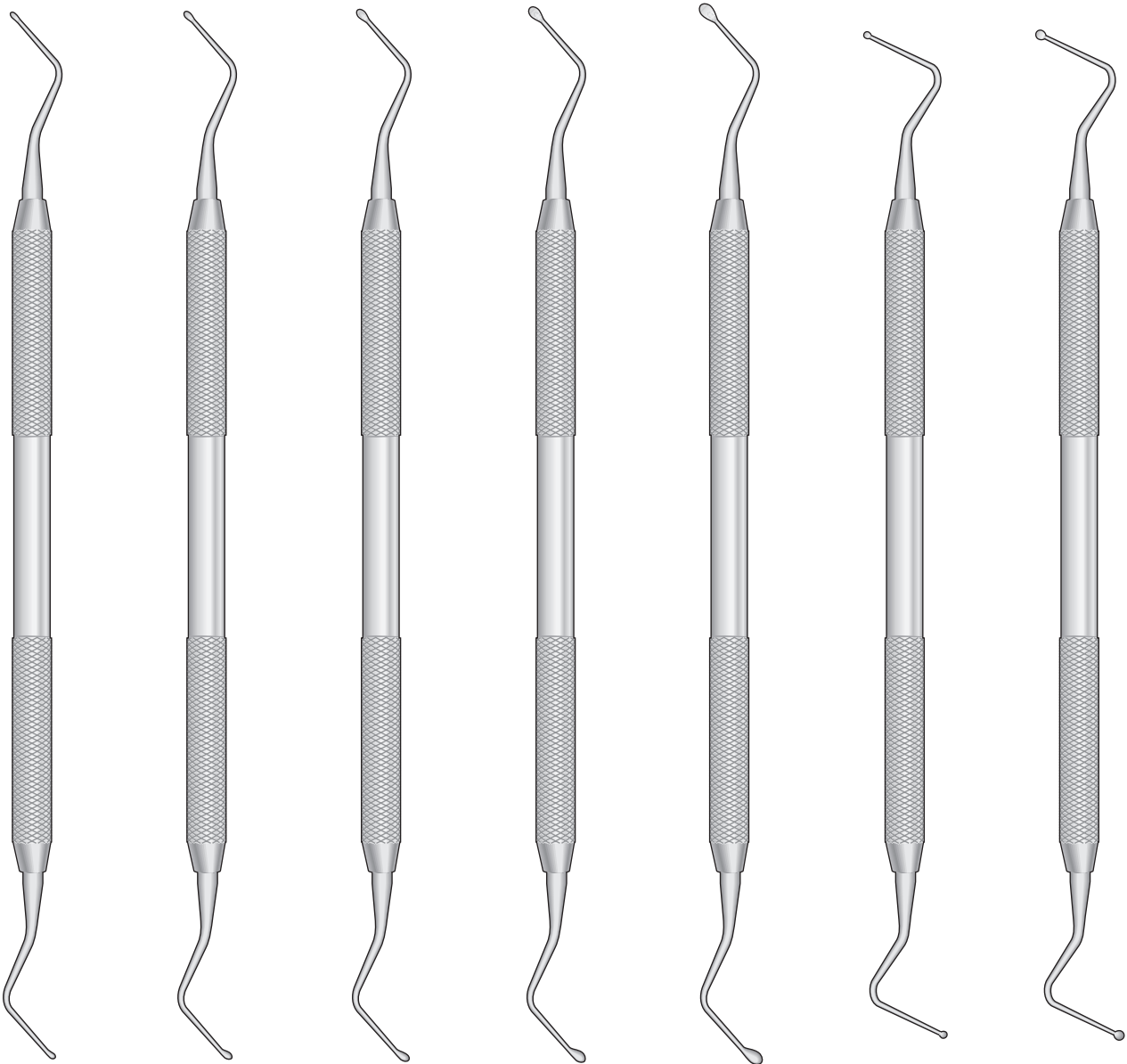

E-0
Fig.0

E-1
Fig.1

E-2
Fig.2

E-3
Fig.3

E-4
Fig.4

EC-1
Fig.1

EC-2
Fig.2

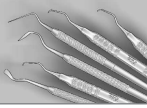

Meißel für Parodontologie
Periodontal Chisels
Scalpelli per parodontologia
Cinceles para la cirugía periodontal
Ciseaux de chirurgie

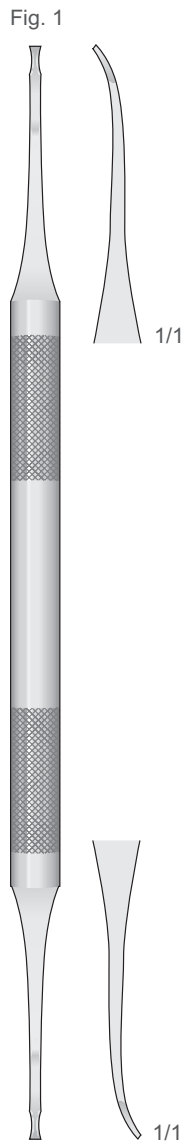

**FEDI
OF-1**
175 mm



**FEDI
OF-2**
175 mm



**FEDI
OF-3**
170 mm

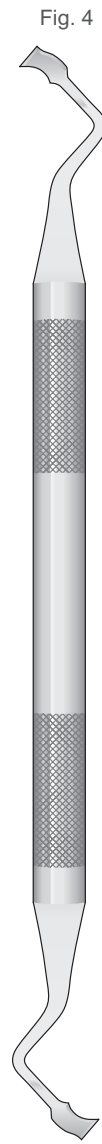

**OCHSENBEIN
OSB-4A**
170 mm

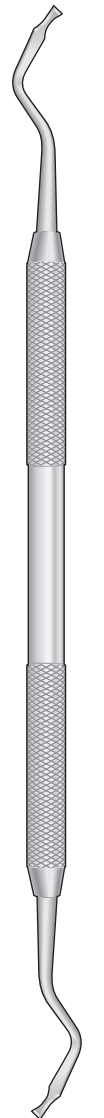

OSB-4
170 mm



Meissel für Parodontologie
Periodontal Chisels
Scalpelli per parodontologia
Cinceles para la cirugía periodontal
Ciseaux de chirurgie

Bevel IN
Fig.1



OCHSENBEIN-1
OSB-1
165 mm

Bevel OUT
Fig.2



OCHSENBEIN-2
OSB-2
165 mm



TG CHISELS
718-113



OCHSENBEIN-3
718-103

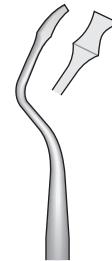

OCHSENBEIN-4
718-104



RHODES BACK ACTION
718-107



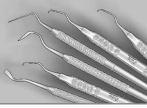

Parodontalmesser
Gingivectomy Knives
Bisturi per gengivectomia
Bisturis para la gengivectomia
Bistouris pour la gengivectomie

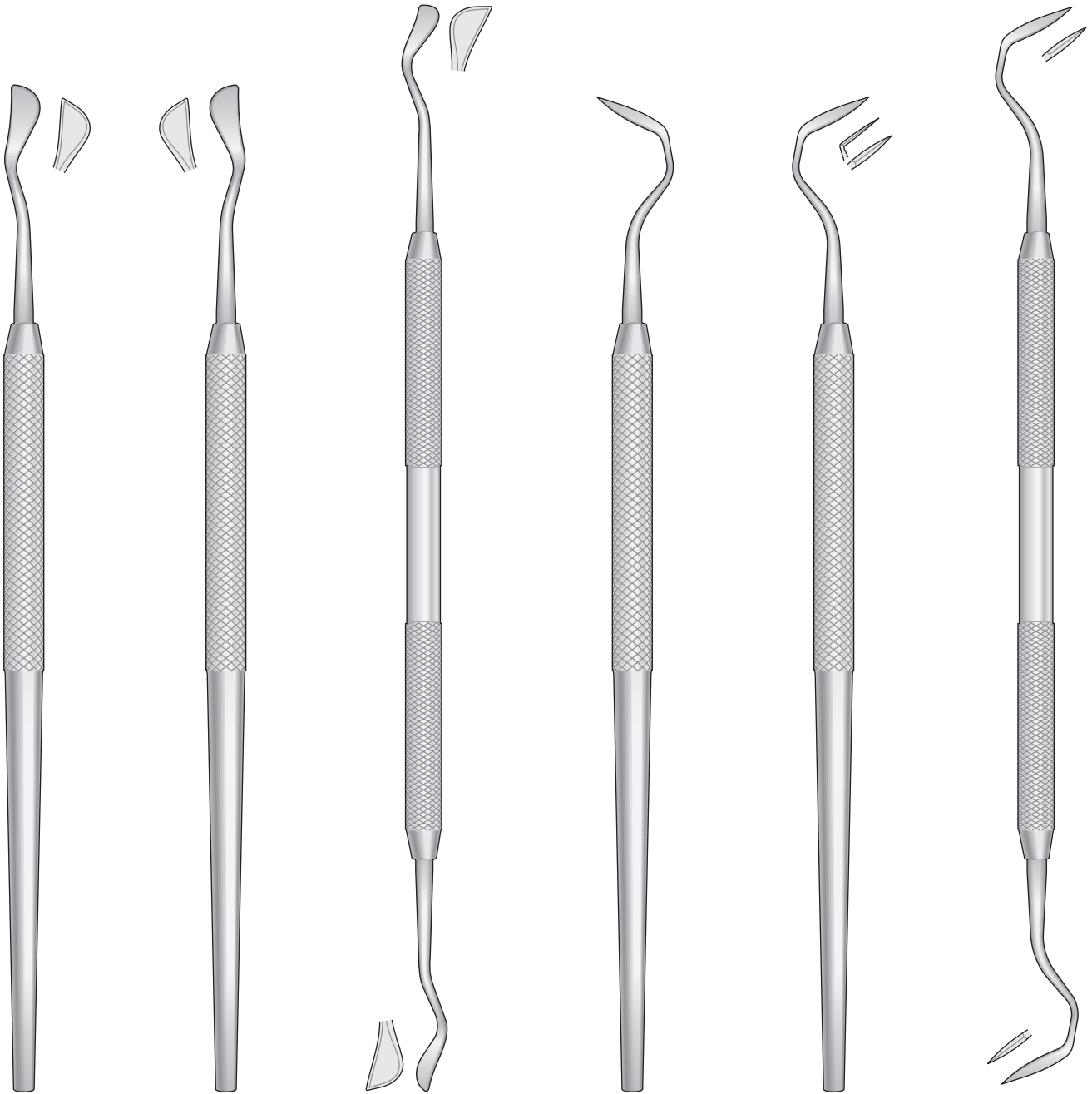

**KIRKLAND
KKD-1**
Fig.15K

**KIRKLAND
KKD-2**
Fig.16K

**KIRKLAND
KKD-4**
Fig.15K - Fig.16K

**ORBAN
OBN-1**
Fig.1

**ORBAN
OBN-2**
Fig.2

**ORBAN
OBN-4**
Fig.1 - Fig.2



Zahnsonden Doppelendig
Double-ended explorers
Sonde doppia
Sondas dobles
Explorateurs doubles

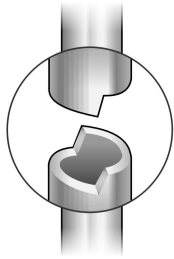

Runder Hohlgriff 8 mm
Hollow Round Handle 8 mm
Manico tondo vuoto 8 mm
Mango hueco 8 mm
Manche rond vide 8 mm



707-23D1
Fig.23/17



707-23D2
Fig.23/17A



707-16D1
Fig.6/23



707-16D2
Fig.6/3



707-UT1
Fig.UT1/2



707-202
Fig.2



707-202A
Fig.2A



707-203
Fig.3



707-6D1
Fig.5/6



707-6D2
Fig.16/17



707-6D3
Fig.16/23

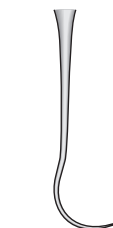
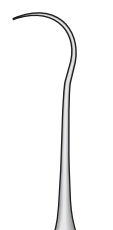

Parodontometer Doppelseitig
Periodontal probes double-ended
Sonde parodontali doppie
Sondas parodontales dobles
Sondes parontales doubles

Runder Hohlgriff 8 mm
Hollow Round Handle 8 mm
Manico tondo vuoto 8 mm
Mango hueco 8 mm
Manche rond vide 8 mm

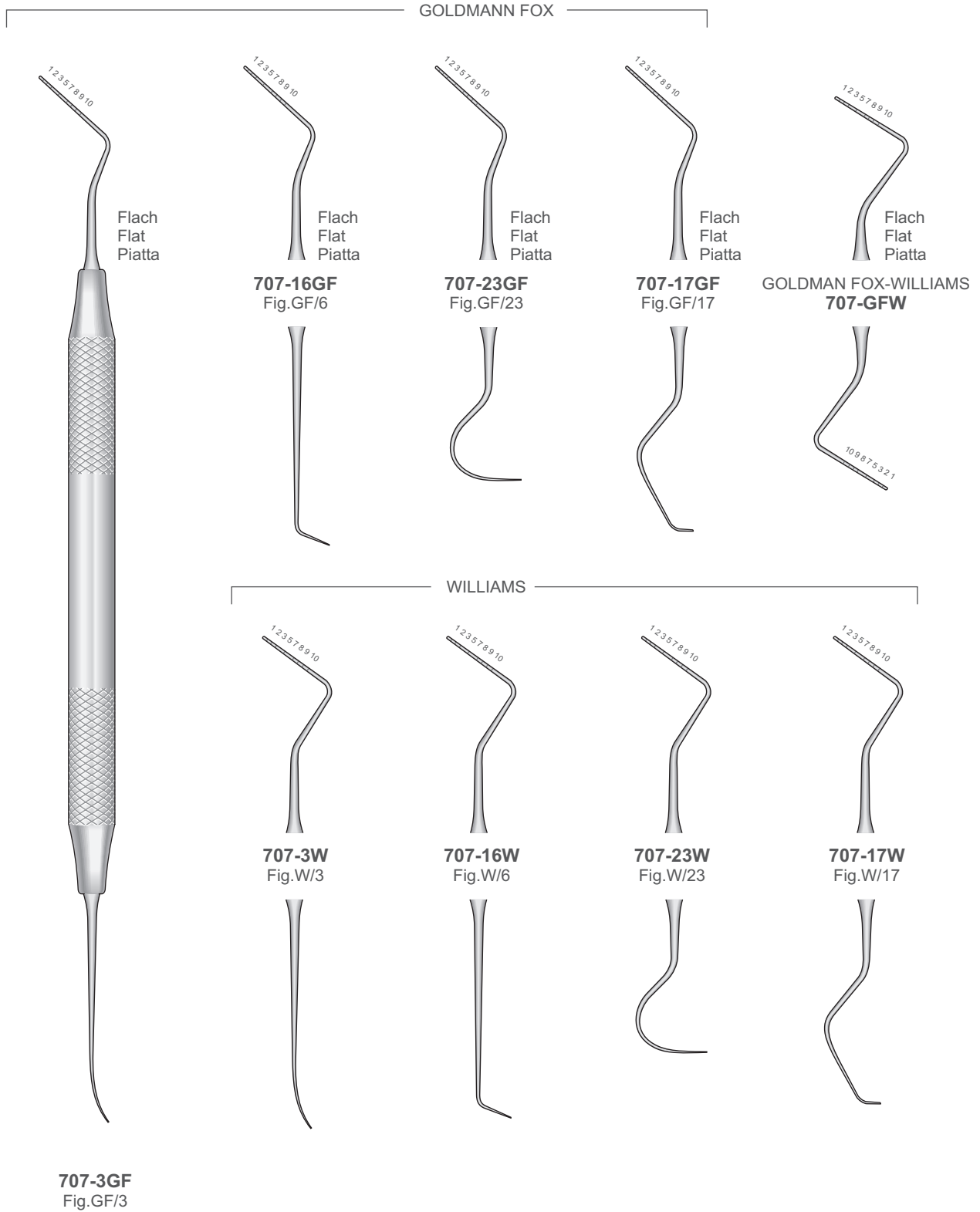
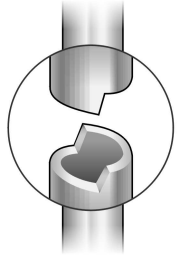



Parodontometer Doppellendig
Periodontal probes double-ended
Sonde parodontali doppie
Sondas parodontales dobles
Sondes parontales doubles

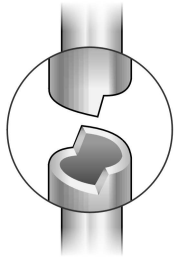

Runder Hohlgriff 8 mm
Hollow Round Handle 8 mm
Manico tondo vuoto 8 mm
Mango hueco 8 mm
Manche rond vide 8 mm

UNIVERSITY OF MICHIGAN



707-3UM
Fig.UM/3



707-16UM
Fig.UM/6



707-23UM
Fig.UM/23

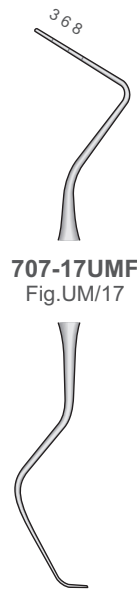

707-17UMF
Fig.UM/17



NABERS
707-1N
Fig. 1N

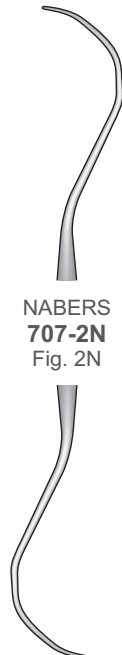

NABERS
707-2N
Fig. 2N

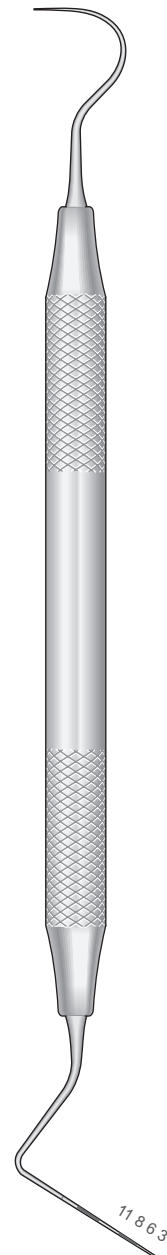

707-2311
Fig.CP11/23

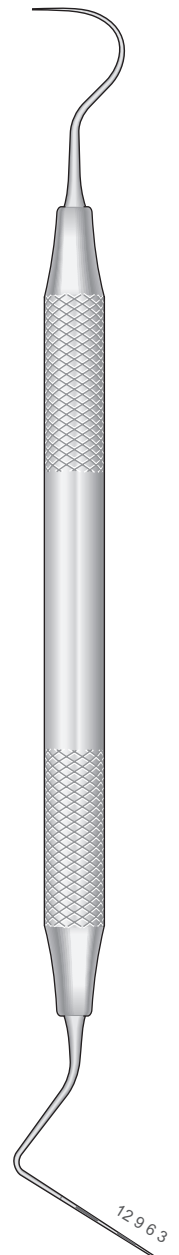

707-2312
Fig.CP12/23

Spateln - Füllungsinstrumente
Spatulas - Filling Instruments
Spatole - Otturatori
Espatulas - Instrumentos para obturaciones
Spatules - Instruments pour obturations

Runder Hohlgriff 8 mm
Hollow Round Handle 8 mm
Manico tondo vuoto 8 mm
Mango hueco 8 mm
Manche rond vide 8 mm

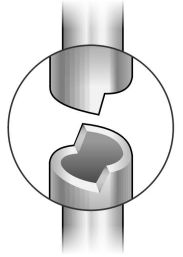

Heidemann Spateln
Heidemann Spatulas
Spatole Heidemann
Espatulas Heidemann
Spatules Heidemann

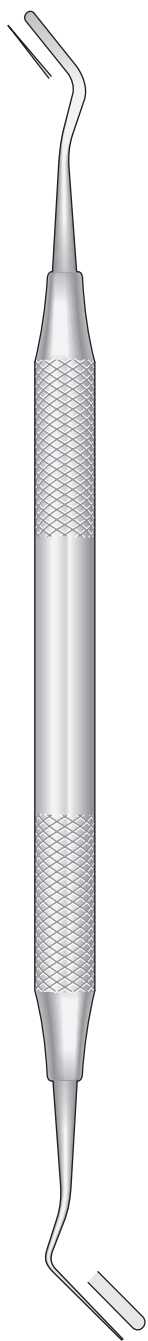

**HEIDEMANN
711-301**
Fig.1

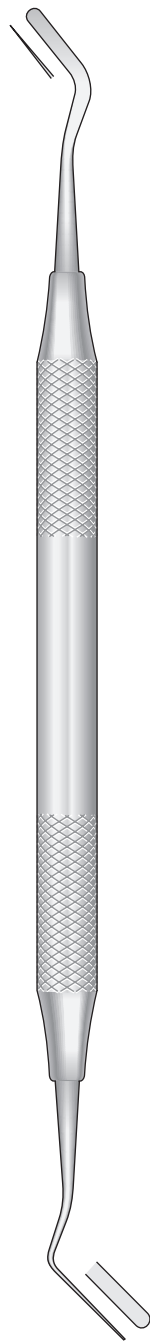

**HEIDEMANN
711-302**
Fig.2

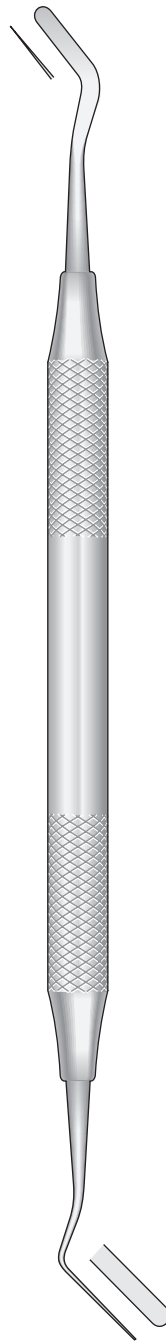

**HEIDEMANN
711-303**
Fig.3



**IPC Fig. 1
715-311**
Interproximal

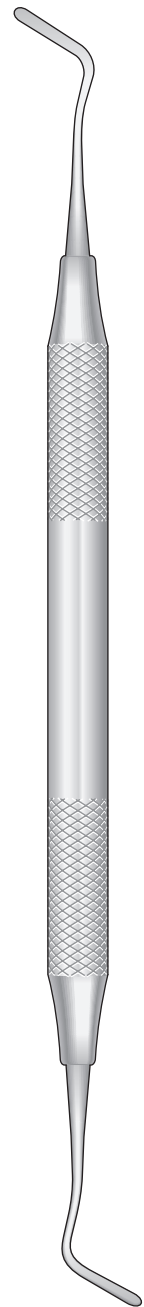

**IPC/OA Fig. 2
715-312**
Interproximal Off-Angle



Füllungsinstrumente

Filling Instruments

Otturatori

Instrumentos para obturaciones

Instruments pour obturations

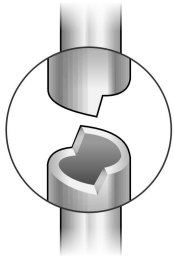

Runder Hohlgriff 8 mm
Hollow Round Handle 8 mm
Manico tondo vuoto 8 mm
Mango hueco 8 mm
Manche rond vide 8 mm



712-101



712-102



712-103



712-104



712-105



712-106



712-18



712-27S



712-29

— BALL —

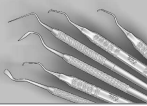

Runder Hohlgriff 8 mm
Hollow Round Handle 8 mm
Manico tondo vuoto 8 mm
Mango hueco 8 mm
Manche rond vide 8 mm

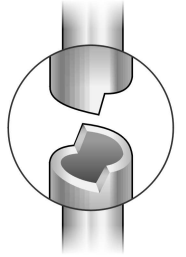

Glatt - Smooth
Lisci - Lisos
Lissée

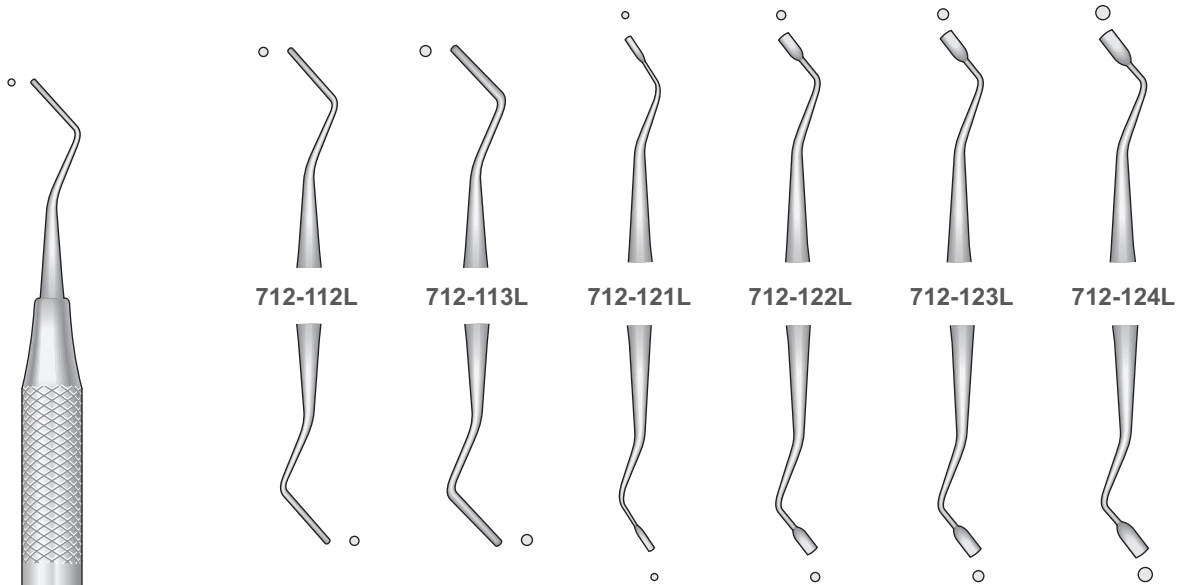

Gerieft - Serrated
Zigrinati - Estriados
Striés

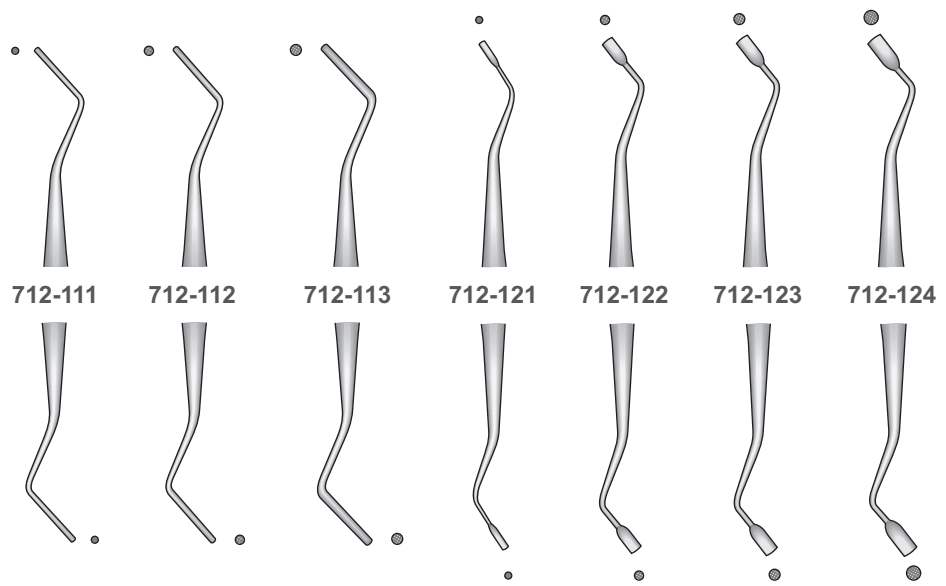

712-111L



Füllungsinstrumente
Filling Instruments
Otturatori
Instrumentos para obturaciones
Instruments pour obturations

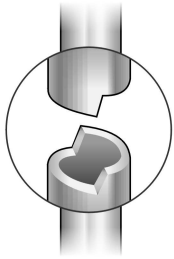

Runder Hohlgriff 8 mm
Hollow Round Handle 8 mm
Manico tondo vuoto 8 mm
Mango hueco 8 mm
Manche rond vide 8 mm



712-PFI
170 mm

HOLLENBACK

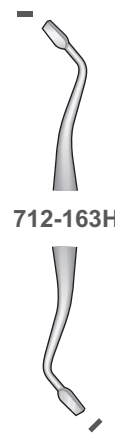

MARKLEY PLUGGERS



Füllungsinstrumente
Filling Instruments
Otturatori
Instrumentos para obturaciones
Instruments pour obturations

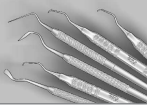

Runder Hohlgriff 8 mm
Hollow Round Handle 8 mm
Manico tondo vuoto 8 mm
Mango hueco 8 mm
Manche rond vide 8 mm

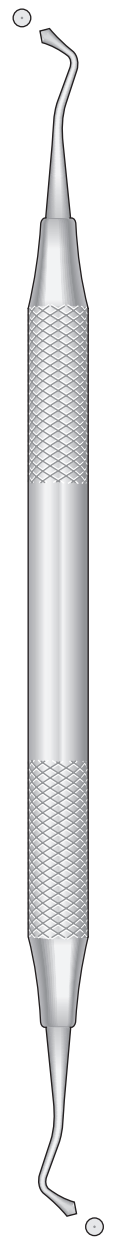
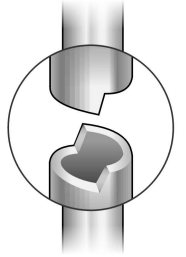

WESTCOTT
712-171

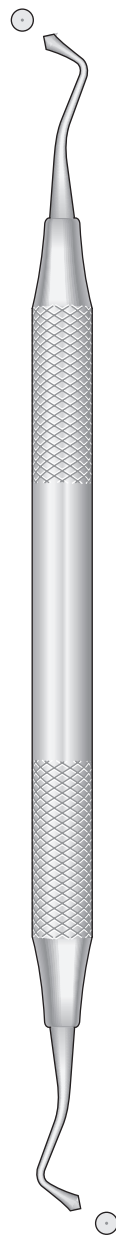

WESTCOTT
712-172

WOODSON

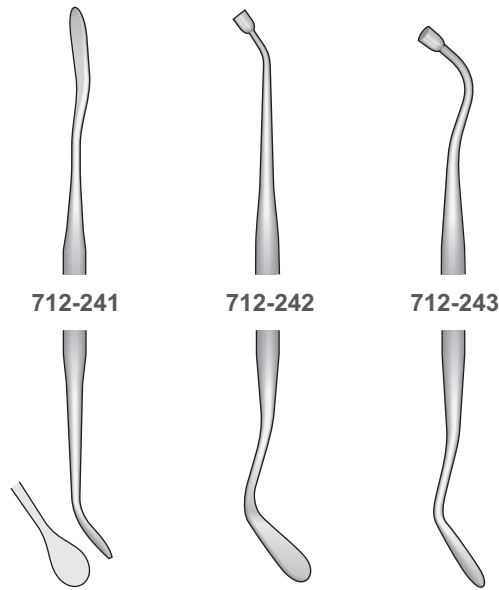

712-241

712-242

712-243

LADMORE

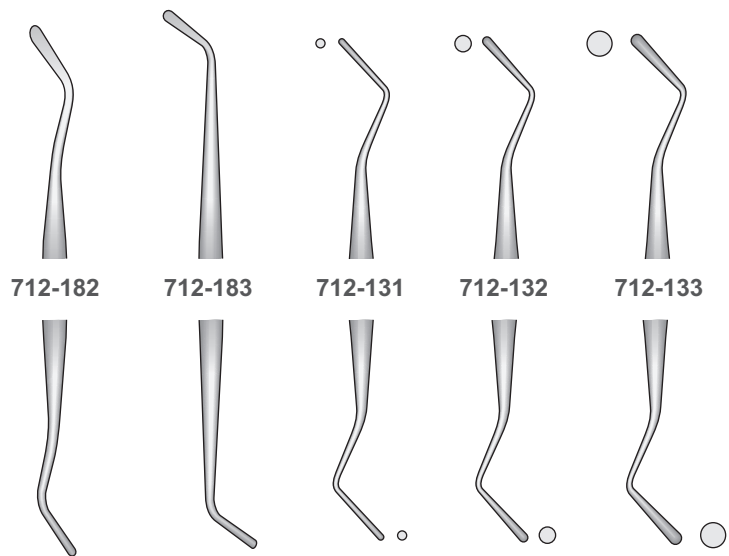

712-182

712-183

712-131

712-132

712-133



Füllungsinstrumente
Filling Instruments
Otturatori
Instrumentos para obturaciones
Instruments pour obturations

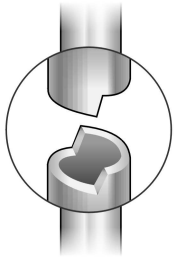

Runder Hohlgriff 8 mm
Hollow Round Handle 8 mm
Manico tondo vuoto 8 mm
Mango hueco 8 mm
Manche rond vide 8 mm



712-251



712-256



712-259



712-191



712-192



712-201



712-202



712-221



712-222



712-223



712-231



712-232



712-233



Instrumente zum Modellieren von Füllungen
Amalgam carvers
Strumenti per modellare e rifinire otturazioni
Instrumentos para modelar las obturaciones
Instruments à modeler les obturations

Runder Hohlgriff 8 mm
Hollow Round Handle 8 mm
Manico tondo vuoto 8 mm
Mango hueco 8 mm
Manche rond vide 8 mm

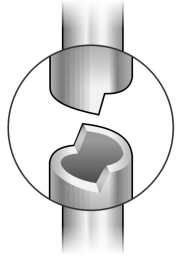

HOLLENBACK



**HOLLENBACK
715-101**



715-102



715-103



715-103S



**CARVER 104
715-404**



**WILAND
715-408**



Schmelzinstrumente
Cavity preparation instruments
Strumenti da smalto
Instrumentos para esmalte
Instruments à émail

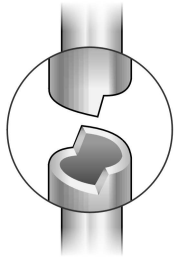

Runder Hohlgriff 8 mm
Hollow Round Handle 8 mm
Manico tondo vuoto 8 mm
Mango hueco 8 mm
Manche rond vide 8 mm

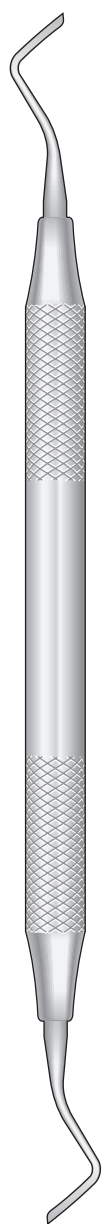

BLACK 26
716-201

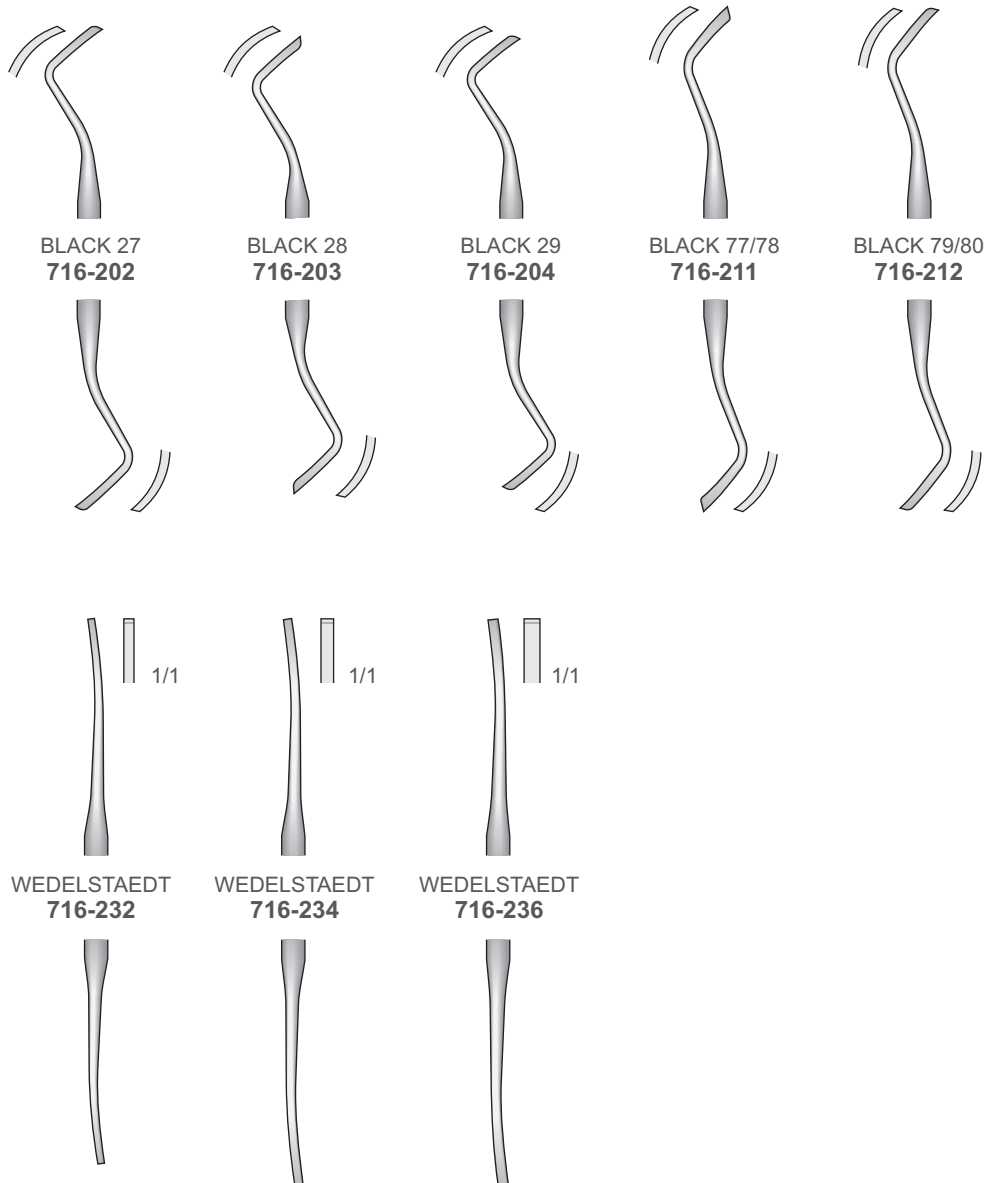

BLACK 27
716-202

BLACK 28
716-203

BLACK 29
716-204

BLACK 77/78
716-211

BLACK 79/80
716-212

WEDELSTAEDT
716-232

WEDELSTAEDT
716-234

WEDELSTAEDT
716-236

Instrumente für die Konservierende Behandlung
Operative Instruments
Strumenti per trattamento conservativo
Instrumentos para operatoria
Instruments pour D.O.

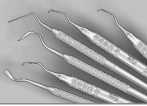

Runder Hohlgriff 8 mm
Hollow Round Handle 8 mm
Manico tondo vuoto 8 mm
Mango hueco 8 mm
Manche rond vide 8 mm

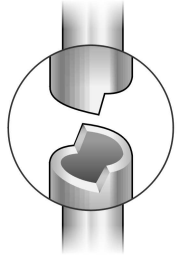

Instrument für Drahrückzug
Instrument for Retractor wire
Strumento per filo retrattore
Instrumento para hilo retractor
Instruments pour fil rtracteur

Cleoids - Discoids

Dykal Applikator
Placement Instruments
Applicatori per sottofondo
Aplicadores de fondo de cavidades
Applicateurs de fond de cavité

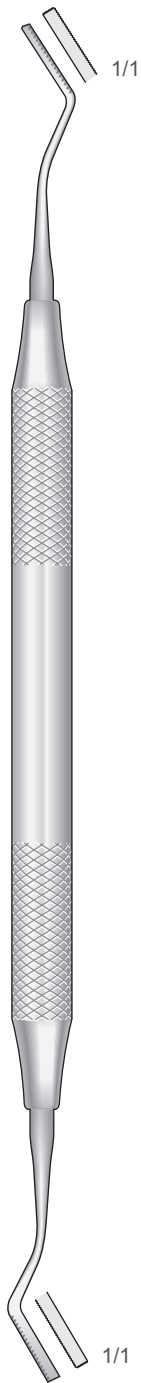

714-CV11

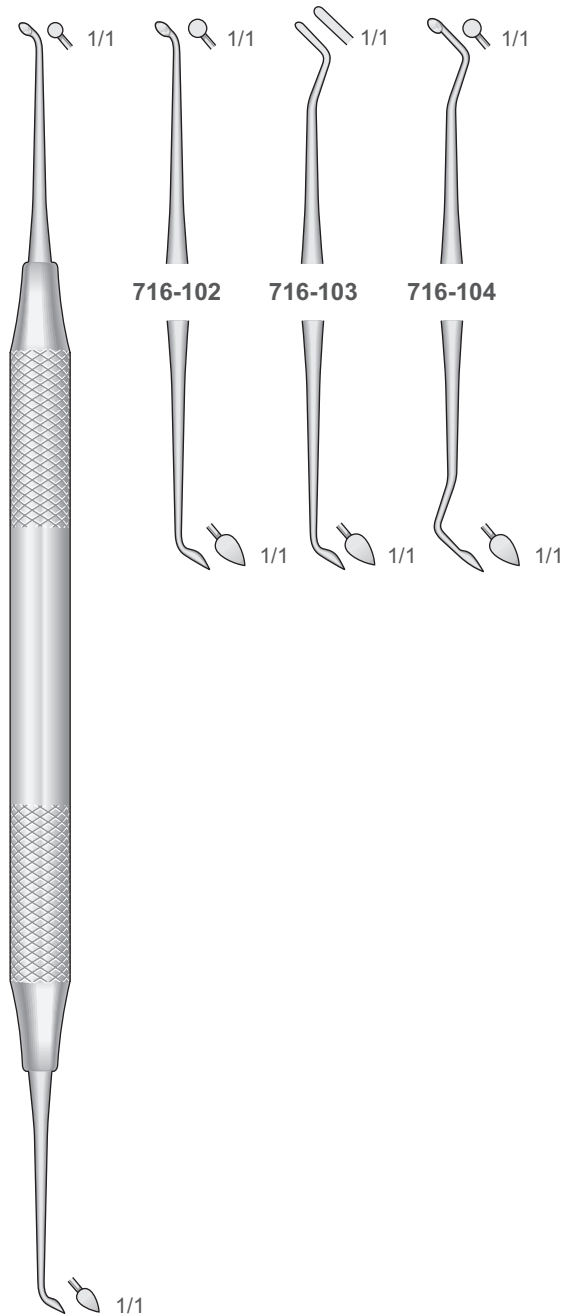

716-101

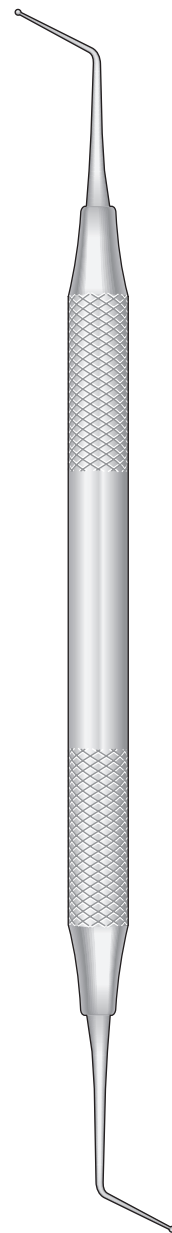

713-101

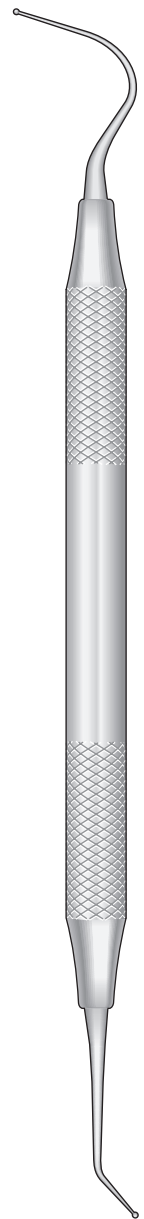

713-102



Excavatoren
Excavators
Escavatori
Excavadores
Excavateurs

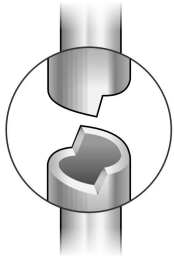

Runder Hohlgriff 8 mm
Hollow Round Handle 8 mm
Manico tondo vuoto 8 mm
Mango hueco 8 mm
Manche rond vide 8 mm



717-100

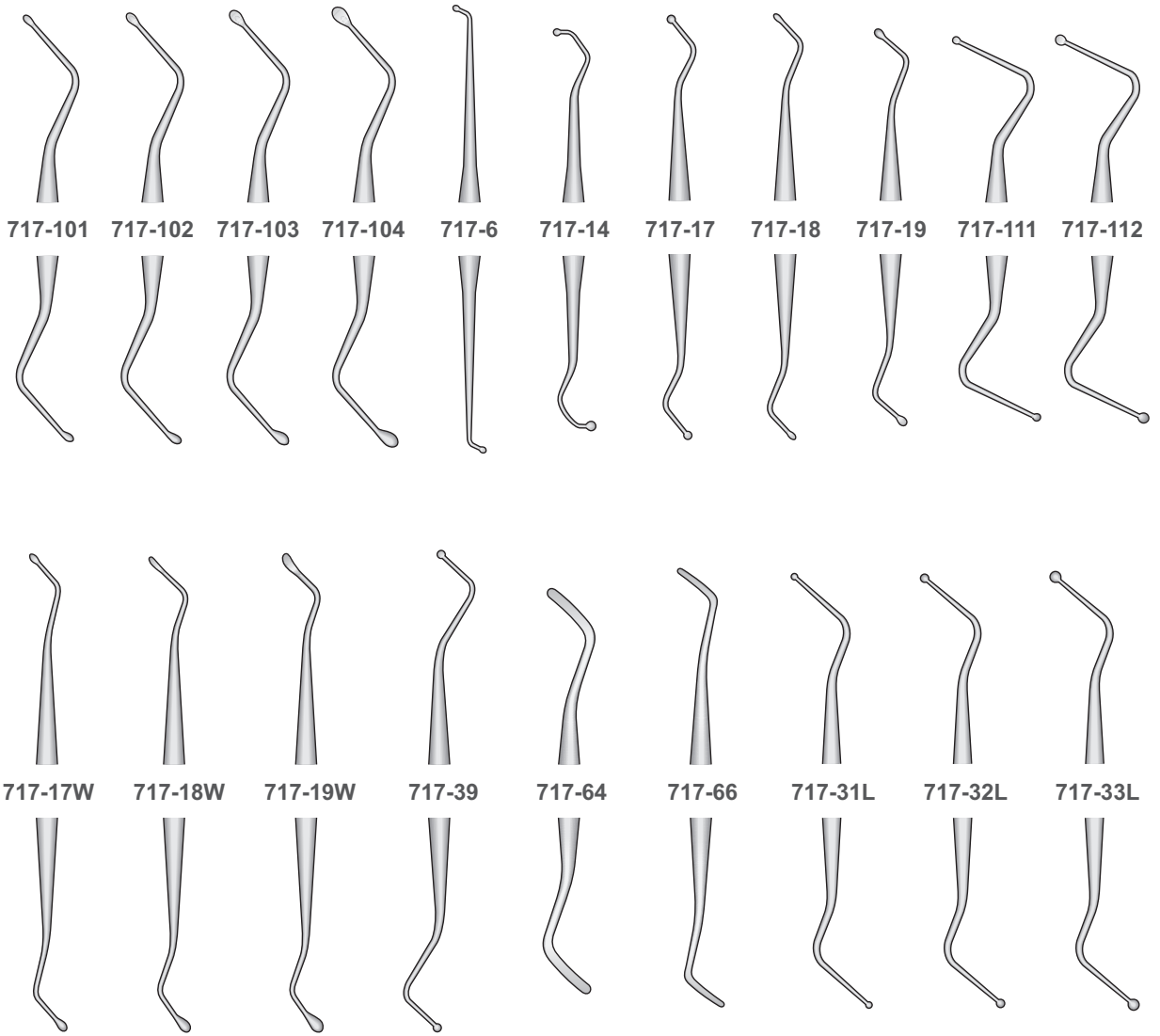

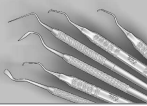

Parodontalmesser
Gingivectomy knives
Bisturi per gingivectomia
Bisturis para la gingivectomia
Bistouris pour la gingivectomie

Runder Hohlgriff 8 mm
Hollow Round Handle 8 mm
Manico tondo vuoto 8 mm
Mango hueco 8 mm
Manche rond vide 8 mm

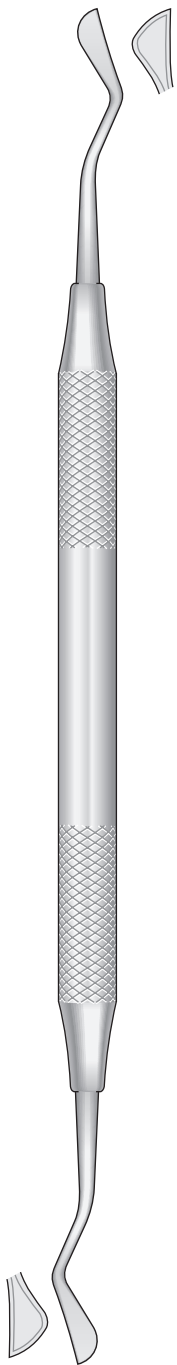
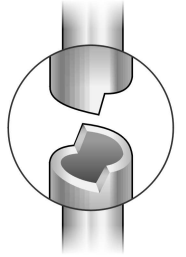

KIRKLAND
718-123
Fig. 15K/16K

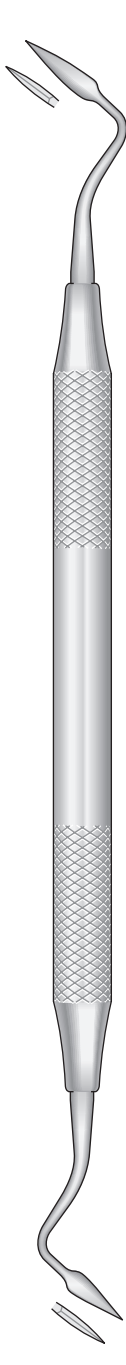

ORBAN
718-133
Fig. 1 / 2



GOLDMAN-FOX
718-147
Fig. 7

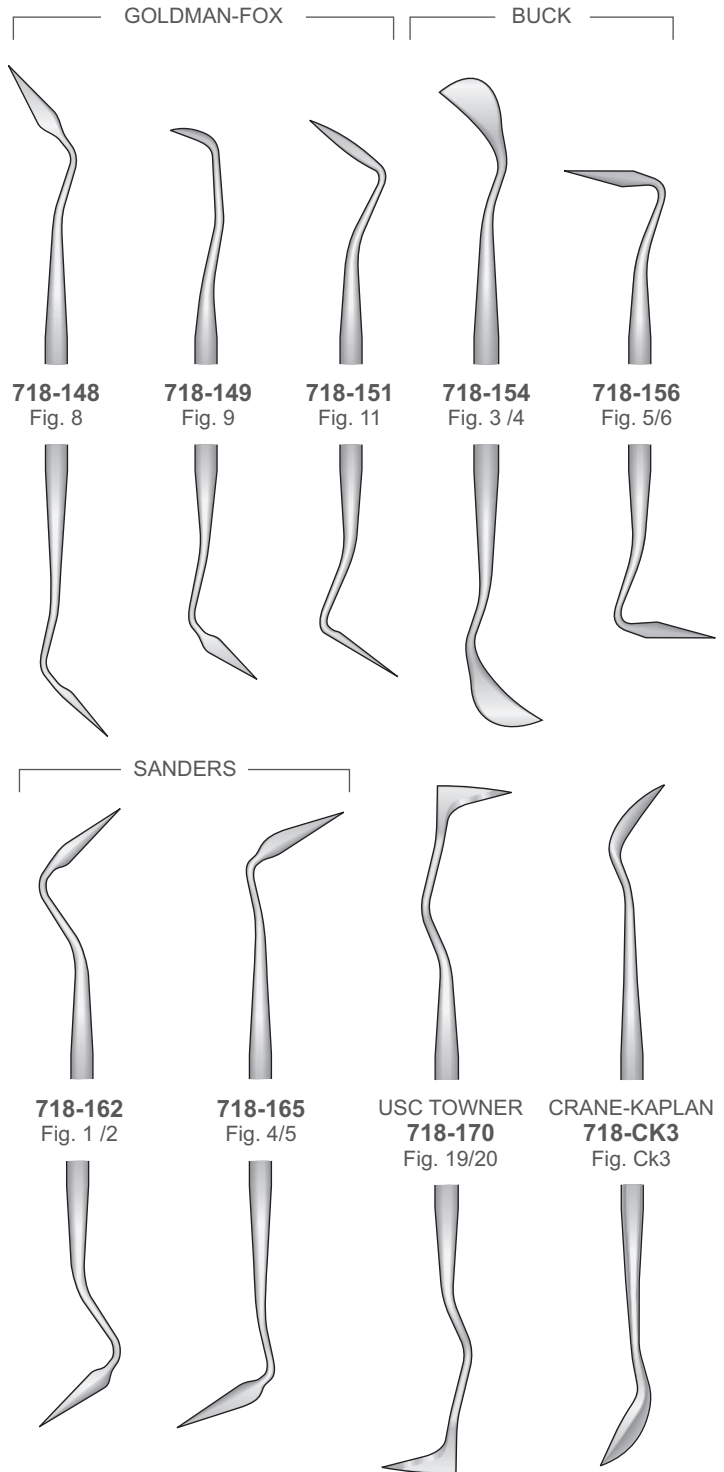

GOLDMAN-FOX | **BUCK**

718-148 Fig. 8
718-149 Fig. 9
718-151 Fig. 11
718-154 Fig. 3 / 4
718-156 Fig. 5/6

SANDERS

718-162 Fig. 1 / 2
718-165 Fig. 4/5
USC TOWNER
718-170 Fig. 19/20
CRANE-KAPLAN
718-CK3 Fig. Ck3



Küretten
Curettes
Curette
Curetas
Curettes

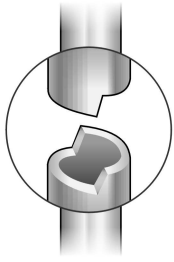

Runder Hohlgriff 8 mm
Hollow Round Handle 8 mm
Manico tondo vuoto 8 mm
Mango hueco 8 mm
Manche rond vide 8 mm

GRACEY



**GRACEY
718-1/2**

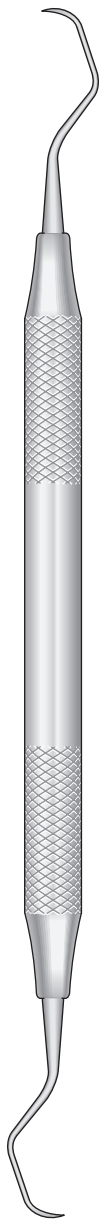

**GRACEY
718-3/4**



**GRACEY
718-5/6**



**GRACEY
718-7/8**

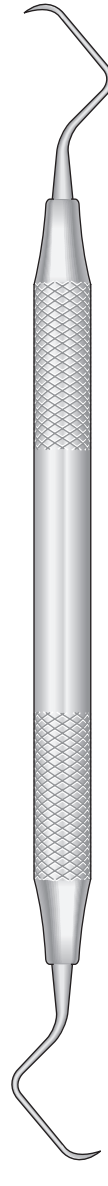

**GRACEY
718-9/10**



**GRACEY
718-11/12**



**GRACEY
718-13/14**

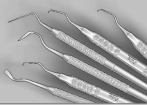

Küretten
Curettes
Curette
Curetas
Curettes

Runder Hohlgriff 8 mm
Hollow Round Handle 8 mm
Manico tondo vuoto 8 mm
Mango hueco 8 mm
Manche rond vide 8 mm

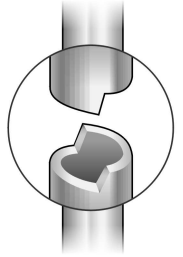

Mesial - Distal



**GRACEY
718-11MD**
Fig. 11/14



**GRACEY
718-13MD**
Fig. 12/13



**DE MARCO
718-251**
Fig. 1



**DE MARCO
718-252**
Fig. 2



**COLUMBIA
718-2RL**
Fig. 2R/2L



**COLUMBIA
718-4RL**
Fig. 4R/4L



**COLUMBIA
718-14**
Fig. 13/14



**LANGER
718-232**
Fig. 1/2



**LANGER
718-234**
Fig. 3/4



Küretten
Curettes
Curette
Curetas
Curettes

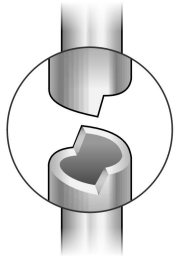

Runder Hohlgriff 8 mm
Hollow Round Handle 8 mm
Manico tondo vuoto 8 mm
Mango hueco 8 mm
Manche rond vide 8 mm

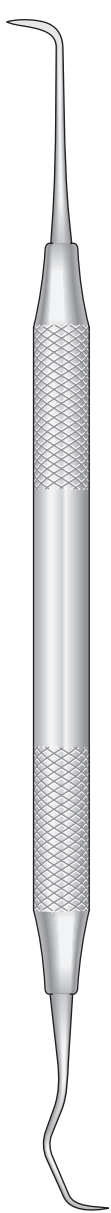

GOLDMAN-FOX
718-271
Fig. 1



GOLDMAN-FOX
718-272
Fig. 2



GOLDMAN-FOX
718-273
Fig. 3



GOLDMAN-FOX
718-274
Fig. 4



GOLDMAN-FOX
718-275
Fig. 5



GOLDMAN-FOX
718-277
Fig. 21

Küretten - Scalers
Curettes - Scalers
Curette - Scalers
Curetas - Scalers
Curettes - Scalers

Runder Hohlgriff 8 mm
Hollow Round Handle 8 mm
Manico tondo vuoto 8 mm
Mango hueco 8 mm
Manche rond vide 8 mm

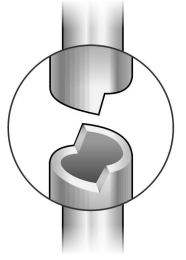

MC CALL
718-282
Fig. 11/12



MC CALL
718-282A
Fig. 11A/12A



MC CALL
718-284
Fig. 13/14



MC CALL
718-284S
Fig. 13S/14S



MC CALL
718-288S
Fig. 17S/18S



JAQUETTE
718-333
Fig. 30/33



JAQUETTE
718-332
Fig. 31/32



JAQUETTE
718-335
Fig. 34/35





Küretten - Scalers
Curettes - Scalers
Curette - Scalers
Curetas - Scalers
Curettes - Scalers

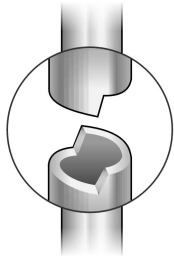

Runder Hohlgriff 8 mm
Hollow Round Handle 8 mm
Manico tondo vuoto 8 mm
Mango hueco 8 mm
Manche rond vide 8 mm



TAYLOR
718-TO3
Fig. 2/3

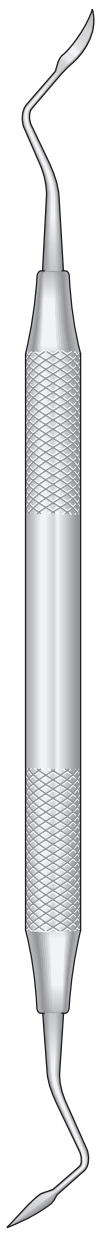

718-204
Fig. 204



718-204S
Fig. 204S

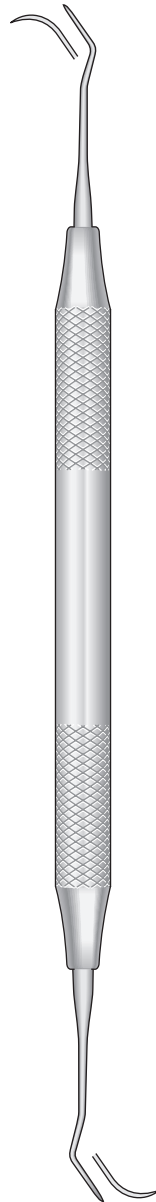

718-204SD
Fig. 204SD



718-CIO3
Fig. 2/3



CRANE-CAPLAN
718-CK6
Fig. 6

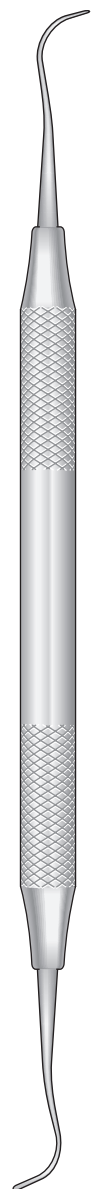

YOUNGER-GOOD
718-YGO8
Fig. 7/8

Küretten - Scalers
Curettes - Scalers
Curette - Scalers
Curetas - Scalers
Curettes - Scalers

Runder Hohlgriff 8 mm
Hollow Round Handle 8 mm
Manico tondo vuoto 8 mm
Mango hueco 8 mm
Manche rond vide 8 mm

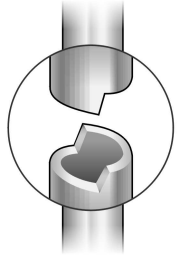

RULE 23/24
718-RO4
Fig. 3 /4



I. UNIVERSITY
718-268
Fig. 17/18



TOWNER-JAQUETTE
719-111
Fig. U15/33



TOWNER-JAQUETTE
719-125
Fig. H5/33



TOWNER-JAQUETTE
719-126
Fig. H6/H7



Kofferdam Instrumente
Rubber-dam Instruments
Strumenti per diga
Instrumentos para dique de goma
Instruments pour digue à caoutchouc

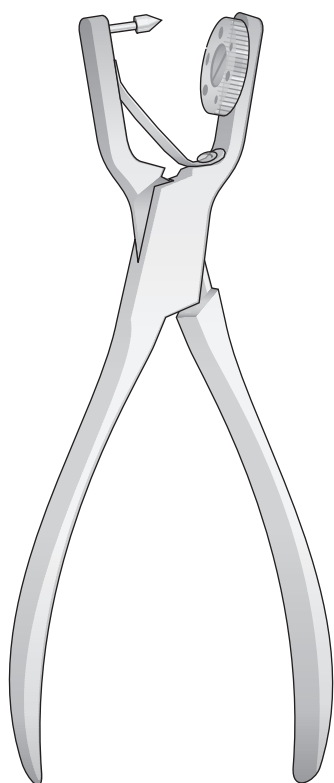

AINSWORTH
DF-02
160 mm

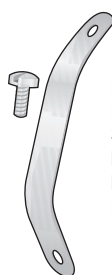

DF-02M
Feder mit Schraube
Spring with screw
Molla con vite
Muelle con tornillo
Ressort avec vis



DF-02R
Lochscheibe
Punch Disk
Disco divisore
Disco agujereado
Disque perforé



DF-02P
Stift, mit Schraube
Pin, with screw
Perno con vite
Punzón con perno
Broche

Lochzangen
Punch Forceps
Pinze foradiga
Perforadores
Pincés à perforer

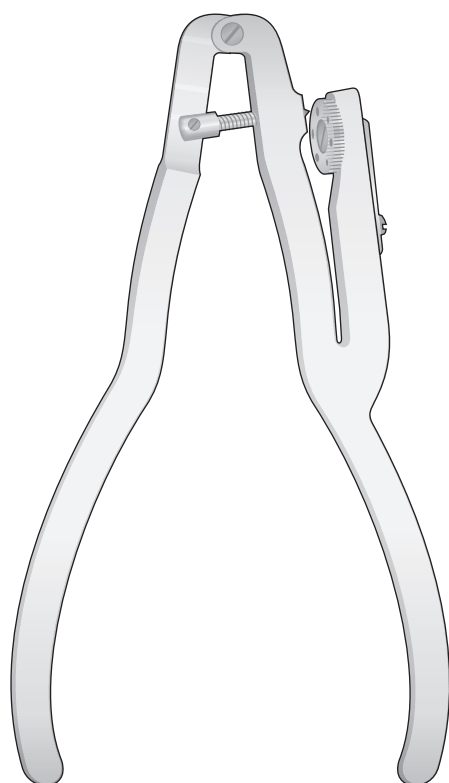

IVORY
DF-00
160 mm



DF-00M
Spiralfeder
Spiral Spring
Molla a spirale
Muelle espiral
Ressort en spirale



DF-00L + DF-00V
Feder mit Schraube
Spring with screw
Molla con vite
Muelle con tornillo
Ressort avec vis



DF-00R
Lochscheibe
Punch Disk
Disco divisore
Disco agujereado
Disque perforé



DF-00P + DF-00N
Stift, mit Schraube
Pin, with screw
Perno con vite
Punzón con perno
Broche avec vis

Lochzangen
Punch Forceps
Pinze foradiga
Perforadores
Pincés à perforer

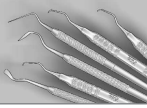

Kofferdam-Klammerzangen
Rubber dam clamp forceps
Pinze per uncini
Pinzas porta-clamps
Pinces porte-crampons

Klammerzangen
Clamps forceps
Pinze per ganci
Pinzas para ganchos
Pinces à crampons

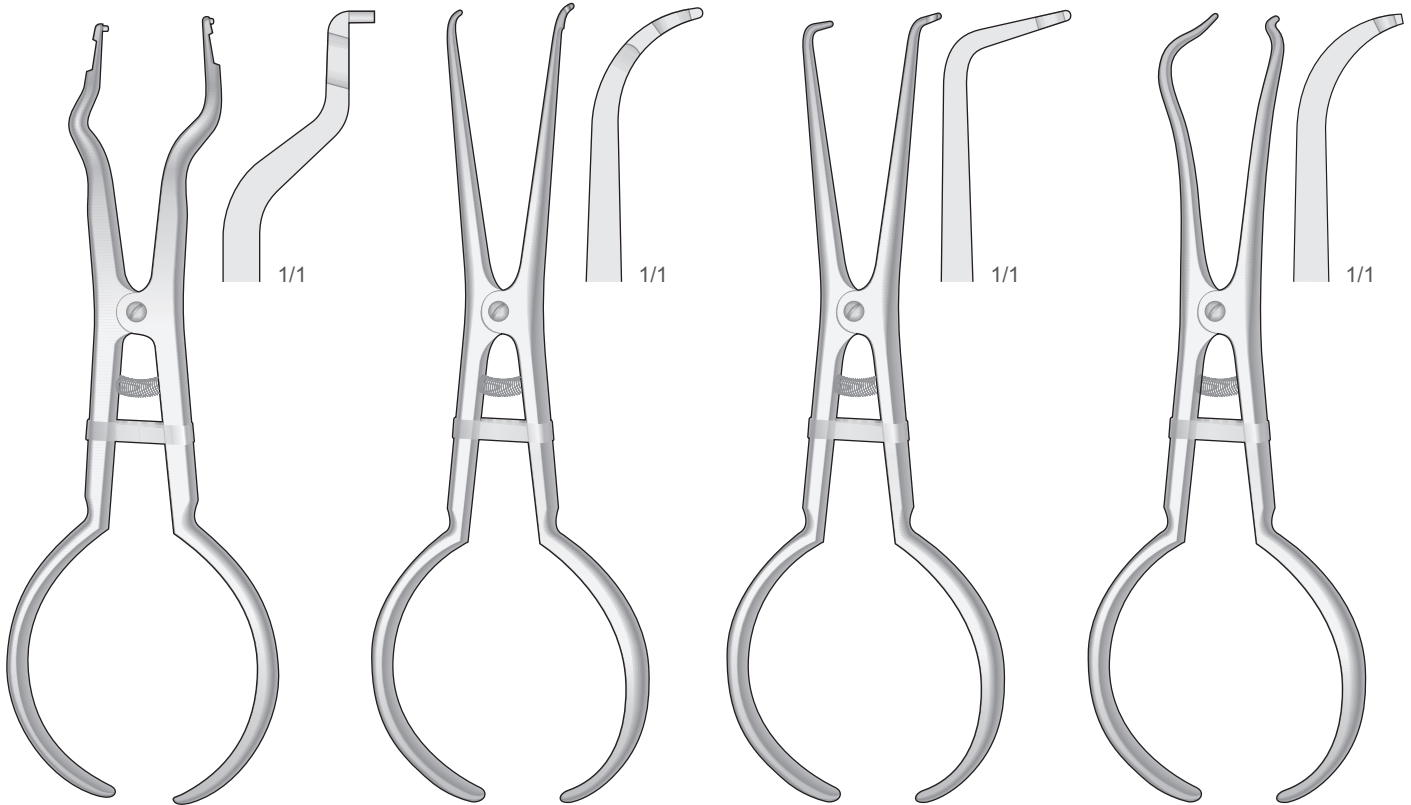

BREWER
DF-10
170 mm

PALMER
DF-15
170 mm

STOKE
DF-16
170 mm

DF-18
170 mm



Matrizenhalter und Matrizenbänder
Matrix Retainers and Matrix Bands
Portamatrici e matrici
Portamatrices y bandas matrices
Porte-matrices et matrices

Molaren, 12 Stück
Molars, 12 pieces
Molari, 12 pezzi
Molares, 12 piezas
Molaires, 12 Pièces

Premolaren, 12 Stück
Premolars, 12 pieces
Premolari, 12 pezzi
Premolares, 12 piezas
Prémolaires, 12 Pièces



DF-40/1
Fig.1



DF-41/4
Fig.4



DF-40/2
Fig.2



DF-41/5
Fig.5



DF-40/3
Fig.3



DF-41/6
Fig.6

Klammerzangen - Clamp Forceps
Pinze per uncini - Porta Clamps
Pincers porte-crampons

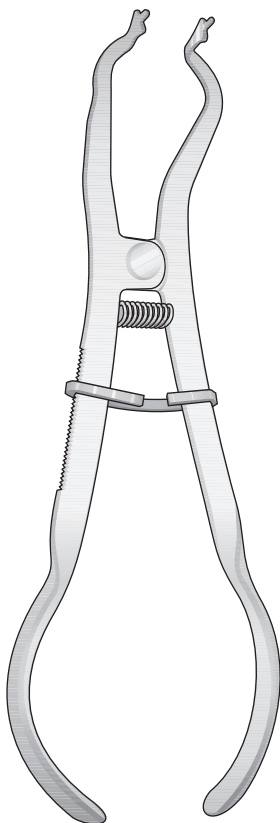

IVORY
DF-12
170 mm

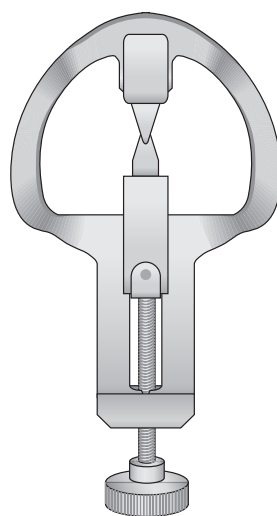

IVORY
DF-43
Fig. 14

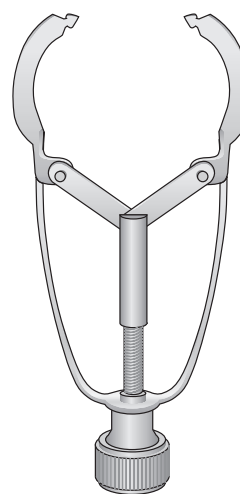

IVORY
DF-40
Fig. 1

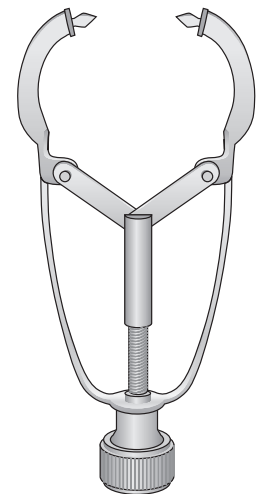

IVORY
DF-41
Fig. 12

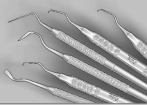

Kofferdam Instrumente
Rubber-dam Instruments
Strumenti per diga
Instrumentos para dique
Instruments pour digue

Kofferdam-Klammern
Rubber-Dam Clamps
Uncini per diga
Clamps para diques
Crampons pour digue



IVORY
DF-126
Fig. 26



IVORY
DF-127
Fig. 27



IVORY
DF-128
Fig. 28



IVORY
DF-129
Fig. 29



IVORY
DF-130
Fig. 30



IVORY
DF-131
Fig. 31



IVORY
DF-151
Fig. 51



IVORY
DF-160
Fig. 60

Kofferdam-Rahmen - Edelstahl
Rubber-Dam Frames - Stainless Steel
Telaio per diga - Inox
Guadro para diques - Inoxidable
Cadre à digue - Inoxidable



DF-30
80x75 mm
Kinder
Children
Bambini
Niños
Enfants

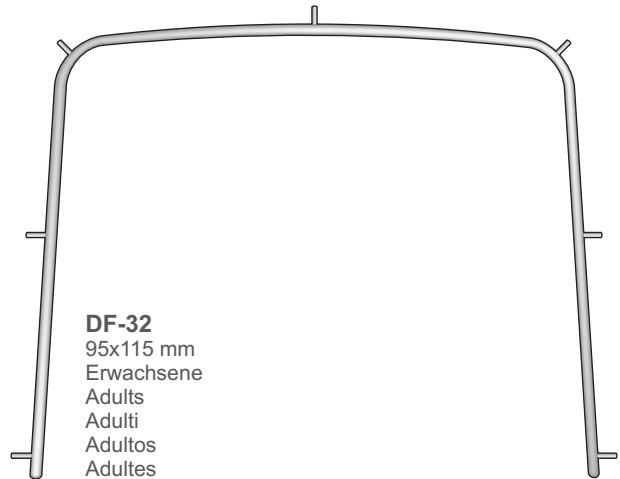

DF-32
95x115 mm
Erwachsene
Adults
Adulti
Adultos
Adultes



Matrizenspanner und Matrizenbänder
 Matrix Retainers and Matrix Bands
 Portamatrici e matrici
 Portamatrices y bandas matrices
 Porte-matrices et matrices

Molaren, 12 Stück
 Molars, 12 pieces
 Molari, 12 pezzi
 Molares, 12 piezas
 Molaires, 12 Pièces

Premolaren, 12 Stück
 Premolars, 12 pieces
 Premolari, 12 pezzi
 Premolares, 12 piezas
 Prémolaires, 12 Pièces

TOFFLEMIRE
 Universal



DF-03/7
 Fig.7



DF-03/11
 Fig.11



DF-03/1
 Fig.1



DF-03/8
 Fig.8



DF-03/12
 Fig.12



DF-03/2
 Fig.2



DF-03/9
 Fig.9



DF-03/13
 Fig.13



DF-03/3
 Fig.3



DF-03/10
 Fig.10

DF-01/5 5 mm x 1 mt
DF-01/6 6 mm x 1 mt
DF-01/7 7 mm x 1 mt



DF-05/5 5 mm x 5 mt
DF-05/6 6 mm x 5 mt
DF-05/7 7 mm x 5 mt

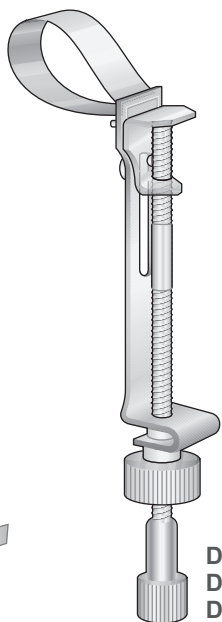

IVORY
DF-06/DF-09
 Fig.8

DF-06 5 mm
DF-08 6 mm
DF-09 7 mm

Paar - Pair
 Coppia - Par
 Paire

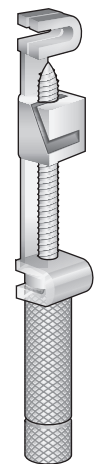

Fig.1
 Rechts
 Right
 Destra
 Derecha
 Droit



Fig.2
 Links
 Left
 Sinistra
 Izquierda
 Gauche

NYSTRÖM
DF-04
 Fig.1 + Fig.2



TOFFLEMIRE
DF-07
 Universal

.12

Absaugkanülen
Suction Tubes
Cannule per aspirazione
Cánulas aspiradoras
Canule aspiratrices

Zahnärztliche Chirurgie
Dental surgery
Chirurgia dentale
Cirugia dental
Chirurgie dentaire

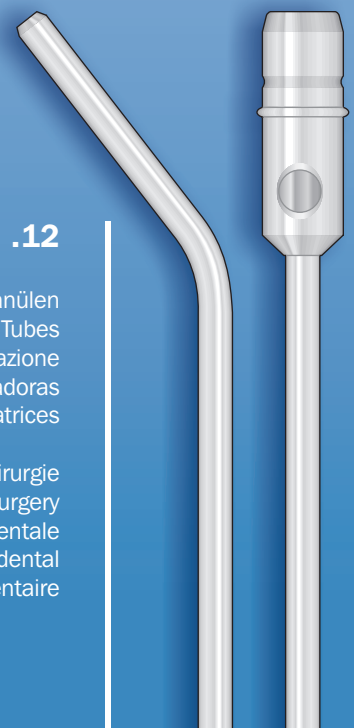

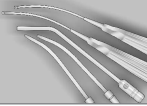

Absaugkanülen
Suction Tubes
Cannule per aspirazione
Cánulas aspiradoras
Canules aspiratrices

Rostfrei
Stainless Steel
Acciaio chirurgico
Acero
Acier

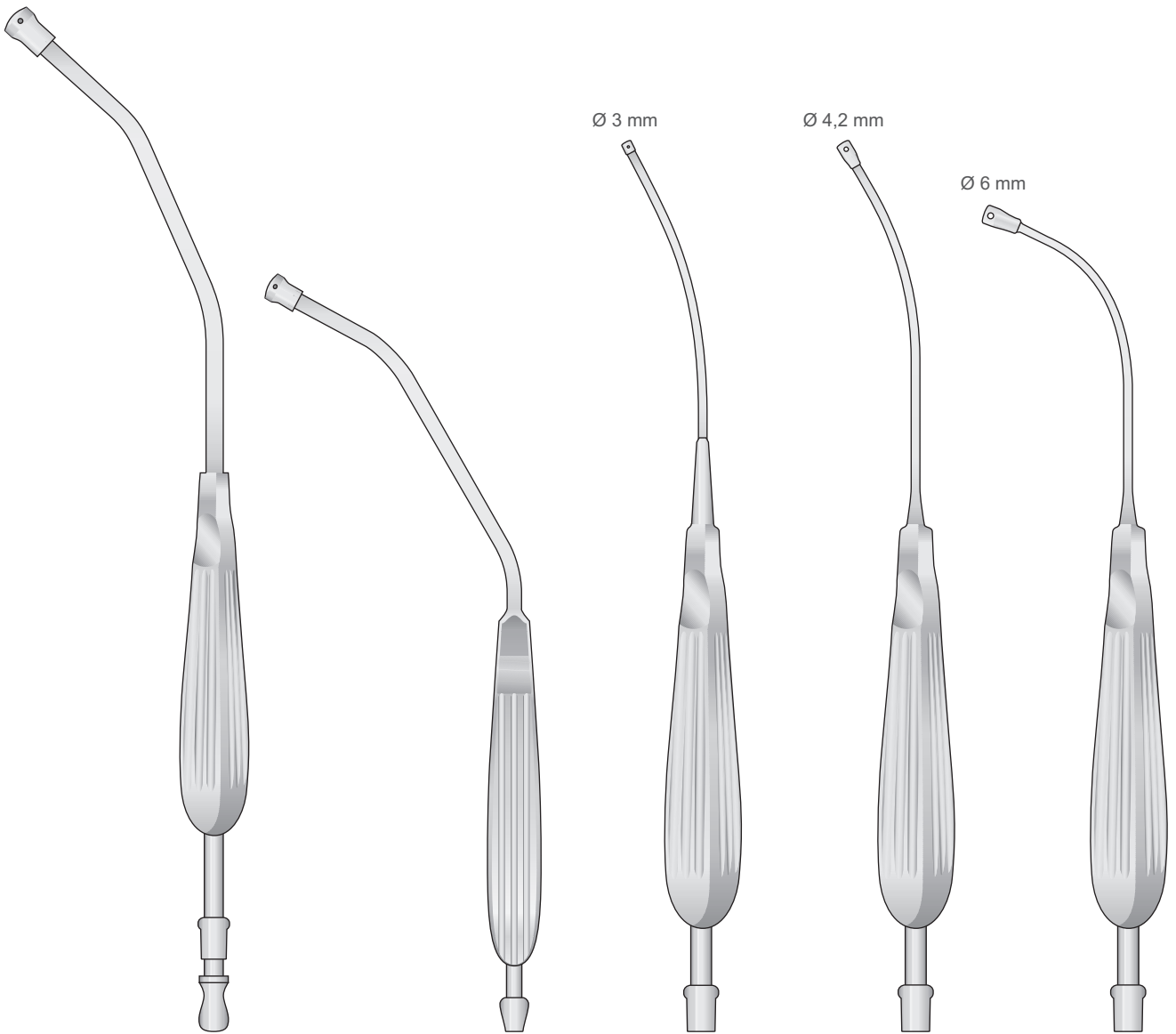

YANKAUER
GF-12
310 mm

BABY-YANKAUER
GF-10
200 mm

ANDREWS-PYNCHON
GF-06
250 mm

ANDREWS-PYNCHON
GF-07
250 mm

ANDREWS-PYNCHON
GF-54
230 mm

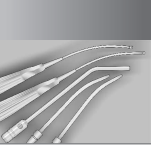

Absaugkanülen
Suction Tubes
Cannule per aspirazione
Cànulas aspiradoras
Canules aspiratrices

Rostfrei
Stainless Steel
Acciaio chirurgico
Acero
Acier

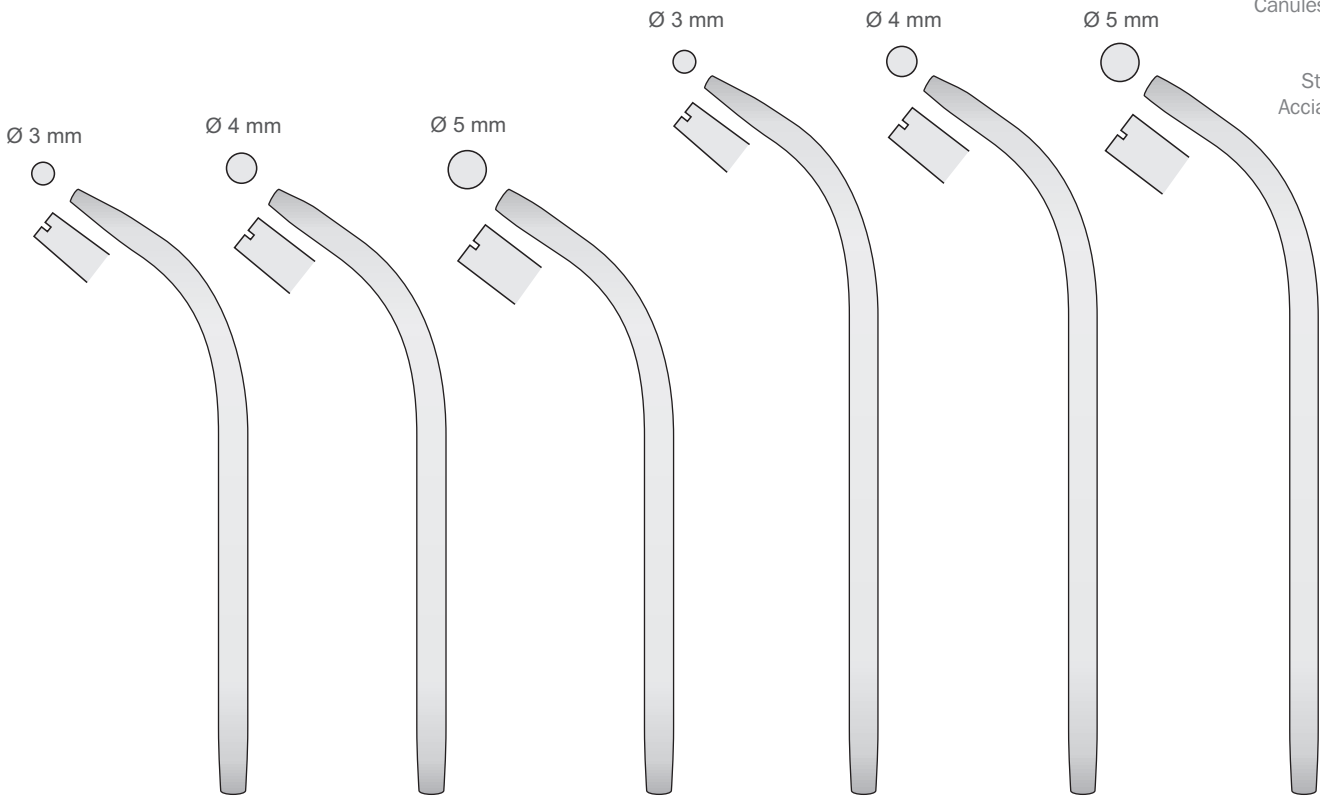

GF-30
140 mm

GF-31
140 mm

GF-32
140 mm

GF-33
170 mm

GF-34
170 mm

GF-35
170 mm

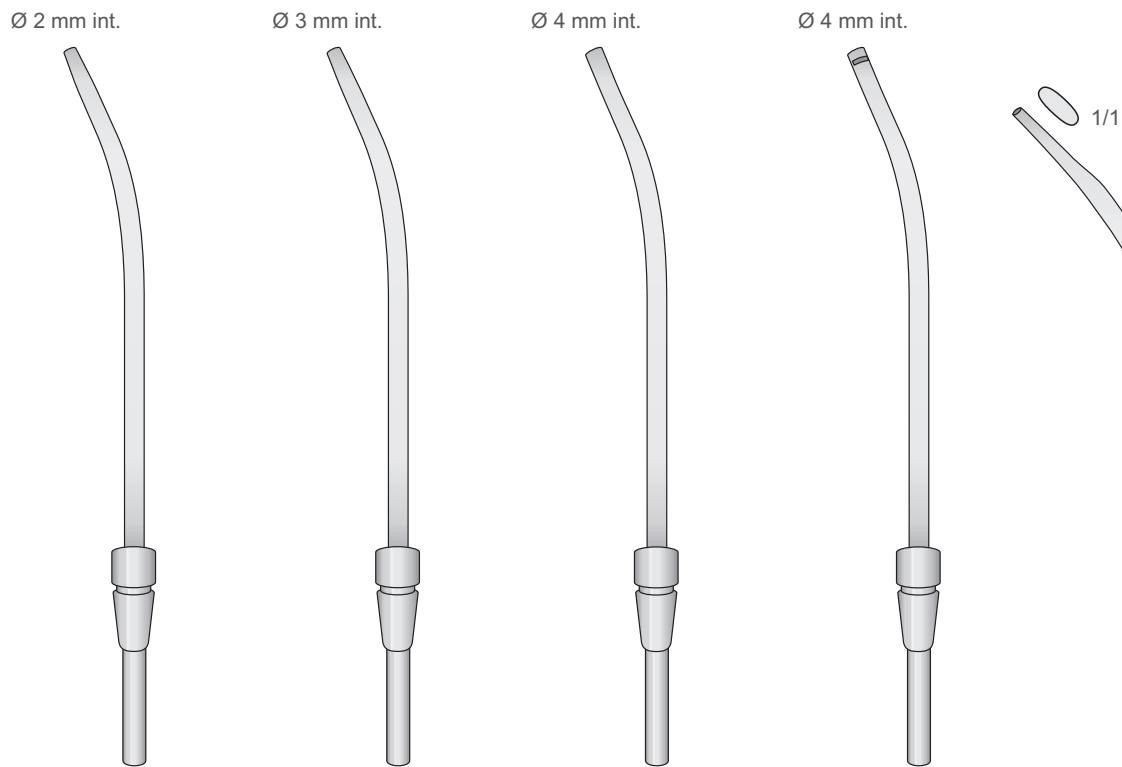

MC. KESSON
GF-13
180 mm

MC. KESSON
GF-14
180 mm

MC. KESSON
GF-15
180 mm

MC. KESSON
GF-16
180 mm

GF-20
160 mm

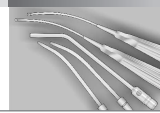

Absaugkanülen
Suction Tubes
Cannule per aspirazione
Cànulas aspiradoras
Canules aspiratrices

Rostfrei
Stainless Steel
Acciaio chirurgico
Acero
Acier

Adaptor
Adapter
Adattatore
Adaptador
Adaptateur

Ø Est. 6,0 mm
Ø Int. 4,5 mm

Autoclavable Tubing

Schlauch - Silikon
Flexible Tube - Silicone
Raccordo in silicone per cannule
Autoclavabile
Tubo flexible de silicona
Tuyau - Silicone
2 mt.



TS-40
75 mm



GF-271
56 mm

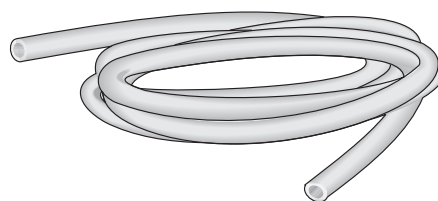

TS-50
2 mt.

Ø 1 mm

Ø 1,5 mm

Ø 2,5 mm

Ø 3,5 mm int.

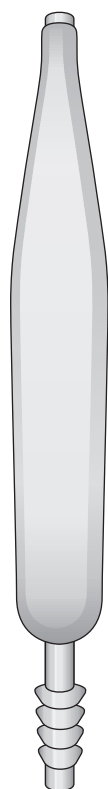

COUPLAND
GF-01
150 mm

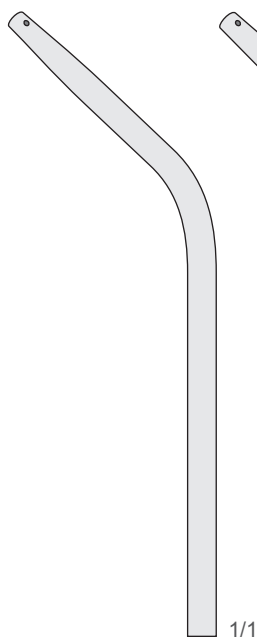

GF-05

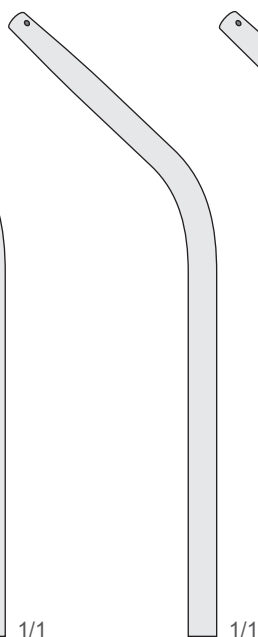

GF-04

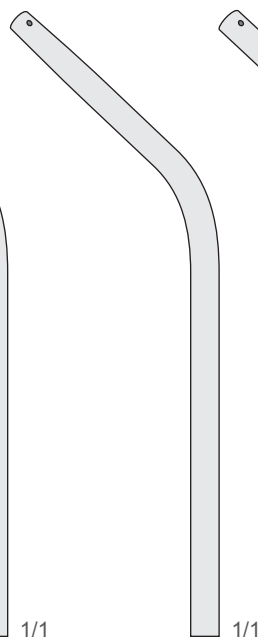

GF-03

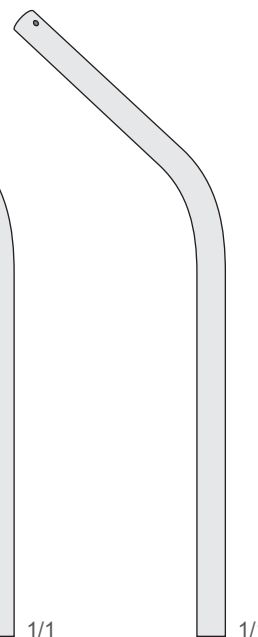

GF-02

GF-11

Set komplett mit Griff + 4 Kanülen
Set complete with handle + 4 tubes
Set completo di manico + 4 cannule
Set completo con mango + 4 cànulas
Set complet avec poignée + 4 canules

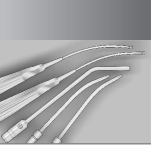

Absaugkanülen
Suction Tubes
Cannule per aspirazione
Cánulas aspiradoras
Canules aspiratrices

Rostfrei
Stainless Steel
Acciaio chirurgico
Acero
Acier

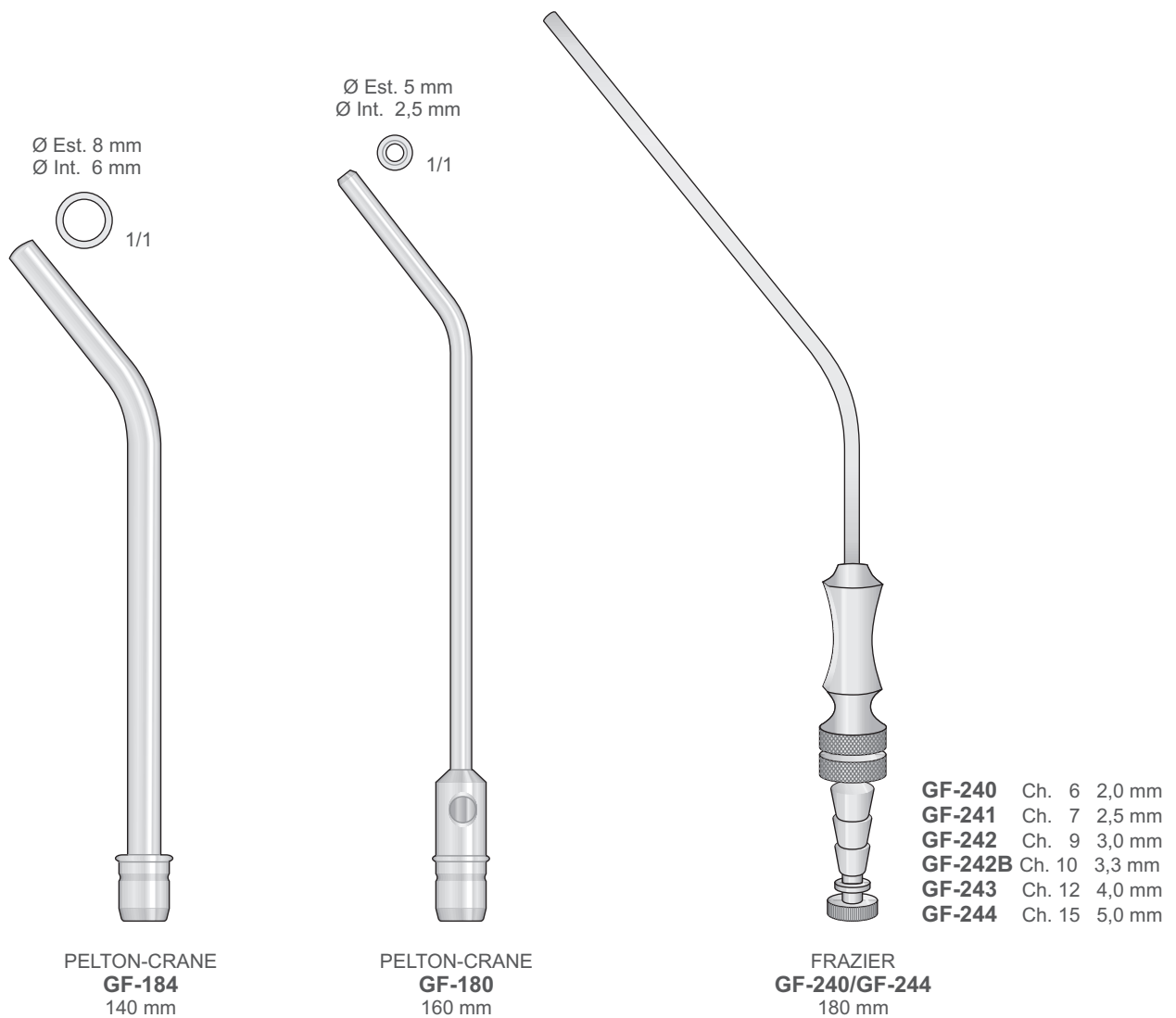

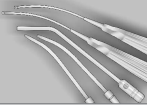

Absaugkanülen
Suction Tubes
Cannule per aspirazione
Cánulas aspiradoras
Canules aspiratrices

Rostfrei
Stainless Steel
Acciaio chirurgico
Acero
Acier

Biegsam
Malleable
Malleabile
Flexible
Flexible

Ø 3 mm

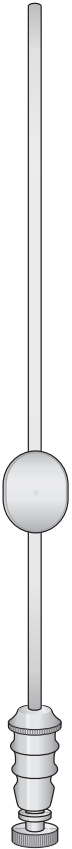

WERTHEIMER
GF-69
160 mm

Biegsam
Malleable
Malleabile
Flexible
Flexible

Ø 3 mm

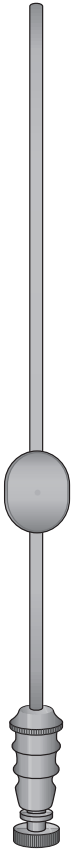

FRAZIER
GF-70
160 mm

Verchromt Schwarz
Chromium Black
Cromata nera
Cromado negro
Chromé noir

Biegsam
Malleable
Malleabile
Flexible
Flexible

Ø 3 mm

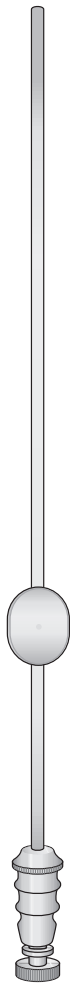

WERTHEIMER
GF-60
200 mm

Biegsam
Malleable
Malleabile
Flexible
Flexible

Ø 3 mm

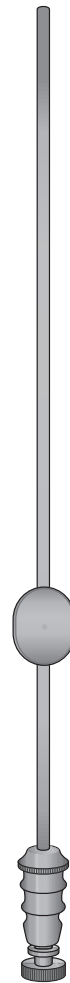

FRAZIER
GF-61
200 mm

Verchromt Schwarz
Chromium Black
Cromata nera
Cromado negro
Chromé noir

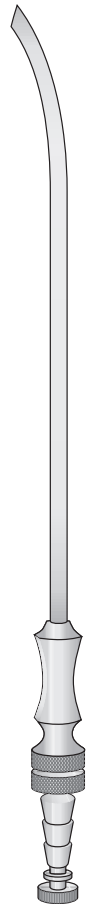

ADSON
GF-41 ch. 12 Ø 4 mm
GF-42 ch. 15 Ø 5 mm
210 mm

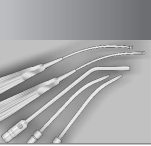

Kanülenreinigungs-Bürsten
Cleaning brush for Tubes
Scovolini per pulizia cannule
Cepillos para limpiar cànulas
Brosse de nettoyage pour canules

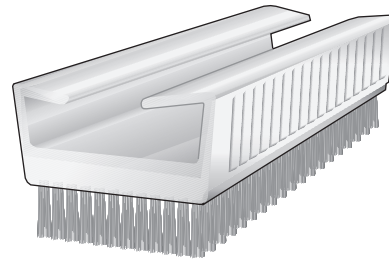

Handwaschbürste
Nail brushes
Spazzola per unghie
Cepillos de uñas
Brosse à ongles

Sterilisier bar
Autoclavable
Autoclavabile
Esterilizabile
Stérilisable

GF-200
4 x 11 cm

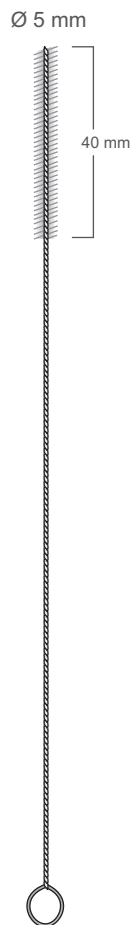

GF-40
235 mm

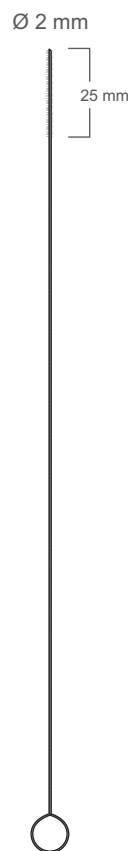

GF-182
215 mm

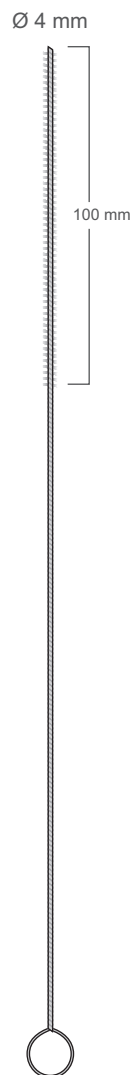

GF-183
300 mm

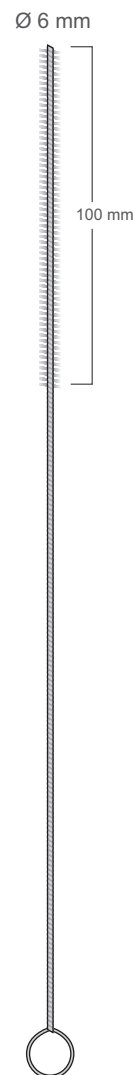

GF-185
300 mm

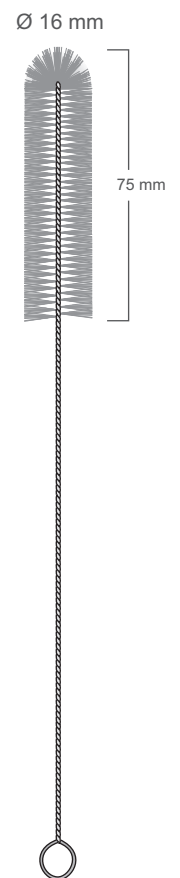

GF-188
220 mm

.13

Kieferorthopädie
Orthodontics
Ortodonzia
Ortodoncia
Orthodontie

Zahnärztliche Chirurgie
Dental surgery
Chirurgia dentale
Cirugia dental
Chirurgie dentaire

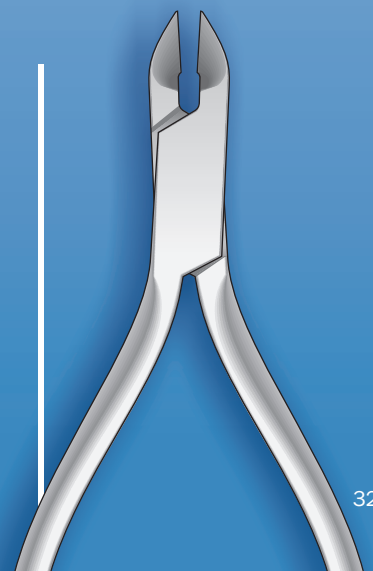



Drahtbiegezaugen
Wire bending Pliers
Pinze per piegare fili
Alicates para doblar alambres
Pincers à pliers les fils

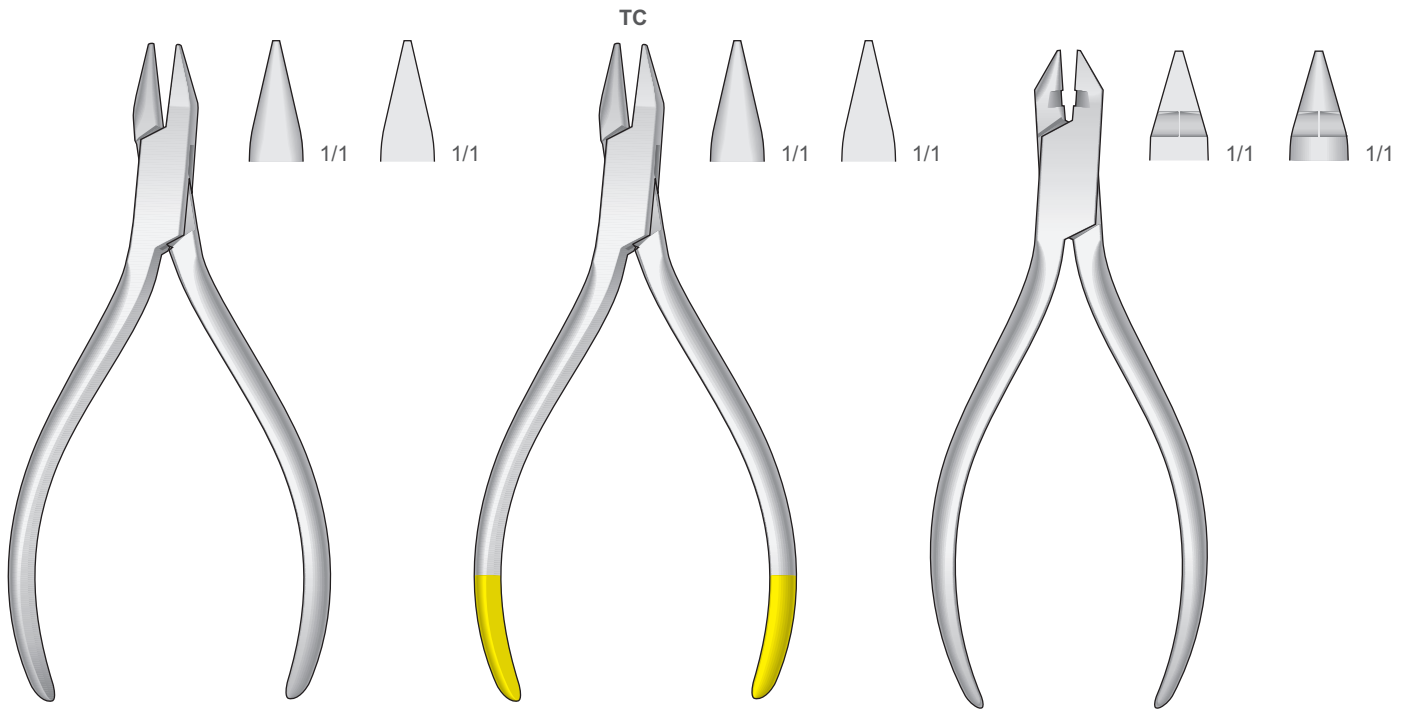

DP-118
130 mm

DP-119
130 mm

DP-121
130 mm

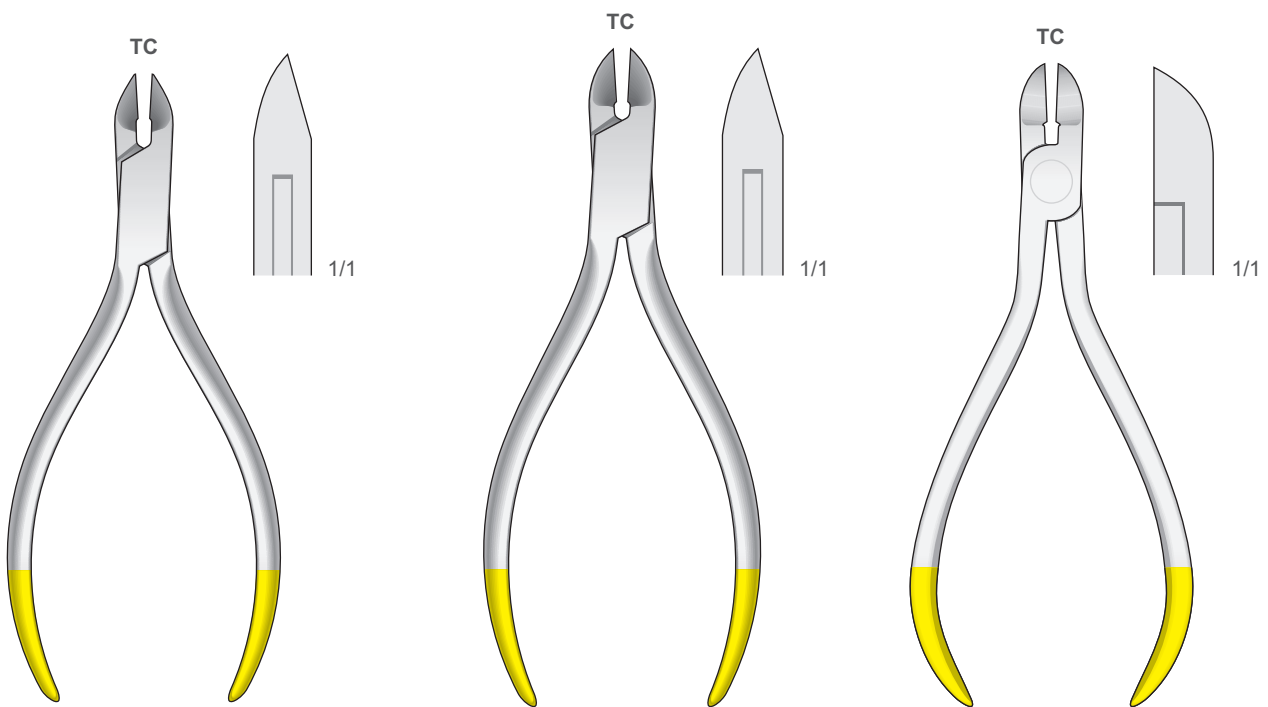

LX-84
125 mm

LX-85
130 mm

LX-87
125 mm

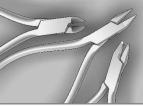

Drahtbiegezaugen
 Wire bending Pliers
 Pinze per piegare fili
 Alicates para doblar alambres
 Pincès à pliers les fils

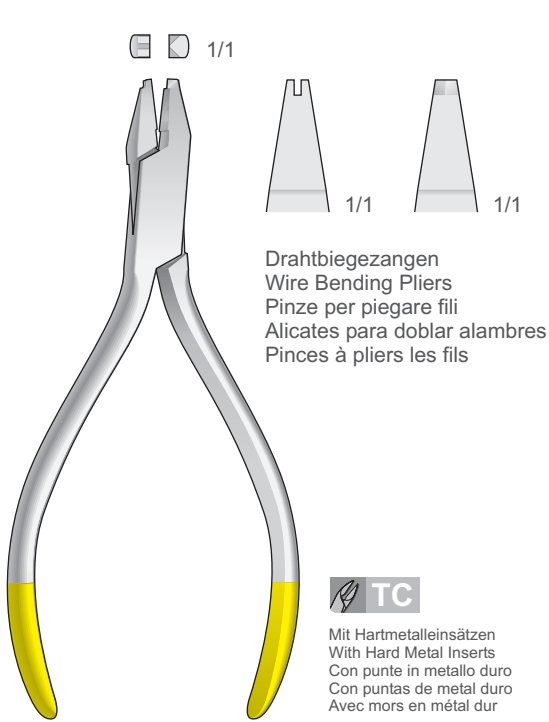

DP-114
130 mm

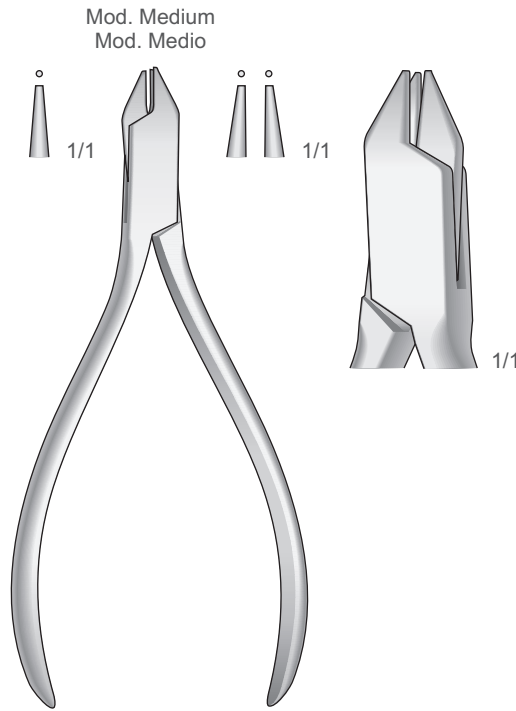

ADERER DP-116
125 mm

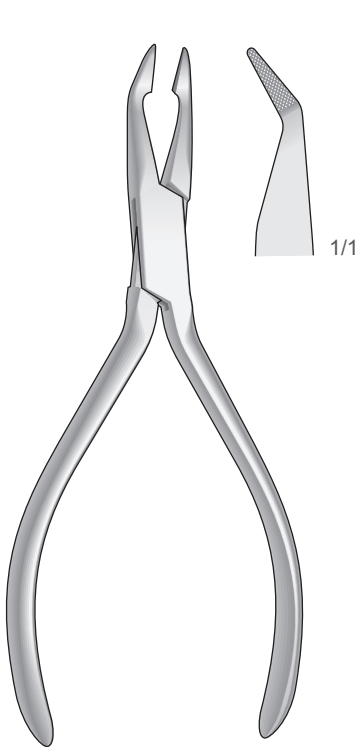

WEINGART DP-134
140 mm

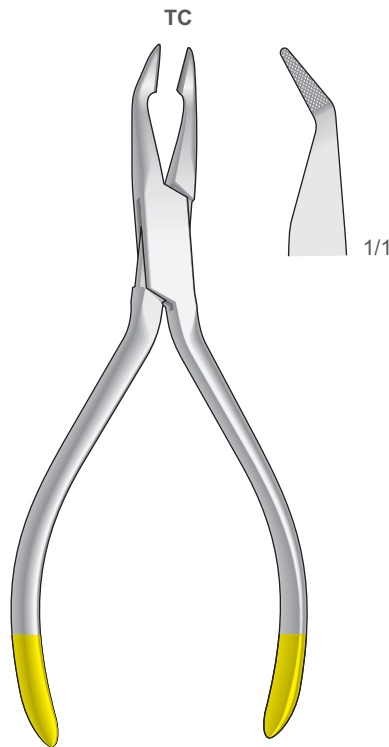

WEINGART DP-135
140 mm

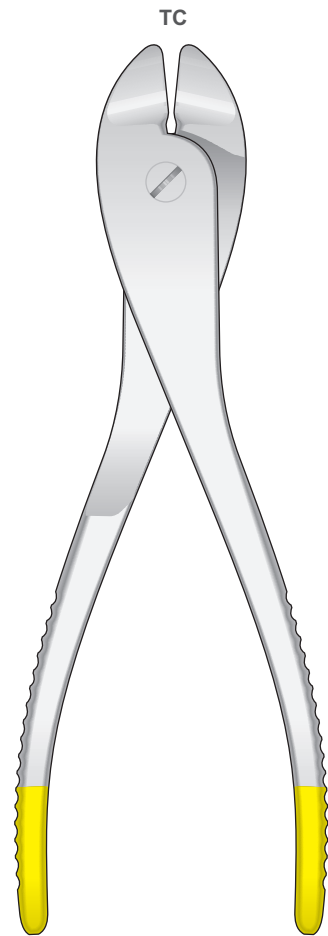

LX-101
185 mm



Drahtschneidezangen
Wire cutting pliers
Tronchesi per fili metallici
Alicates para cortar alambre
Pinces à couper les fils

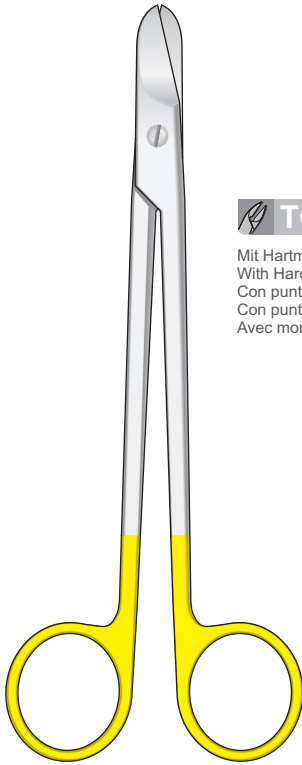

Mit Hartmetalleinsätzen
With Hard Metal Inserts
Con punte in metallo duro
Con puntas de metal duro
Avec mors en métal dur

**SMITH
FG-160**
160 mm

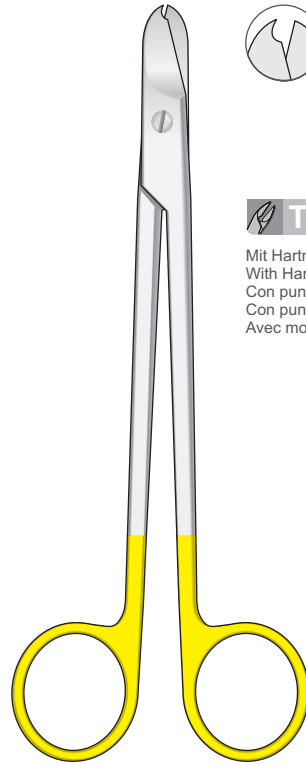

Mit Hartmetalleinsätzen
With Hard Metal Inserts
Con punte in metallo duro
Con puntas de metal duro
Avec mors en métal dur

**SMITH
FG-161**
160 mm

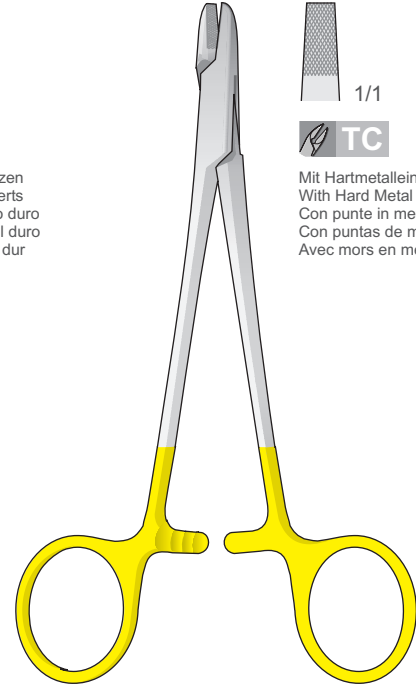

1/1



Mit Hartmetalleinsätzen
With Hard Metal Inserts
Con punte in metallo duro
Con puntas de metal duro
Avec mors en métal dur

PH-58
150 mm

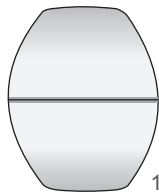
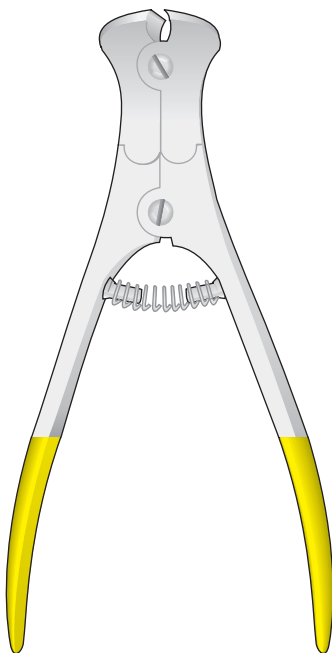

1/1



Mit Hartmetalleinsätzen
With Hard Metal Inserts
Con punte in metallo duro
Con puntas de metal duro
Avec mors en métal dur

○ Max Ø 2.0 mm (.078")

Für weichen Draht
For soft Wire
Per filo leggero
Para alambre blando
Pour fil léger

○ Max Ø 1.5 mm (.059")

Für harten Draht
For hard Wire
Per filo duro
Para alambre duro
Pour fil dur

LX-102
145 mm

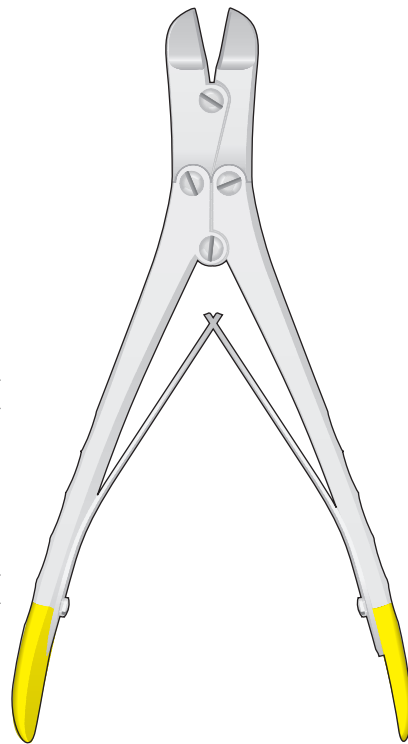

1/1



Mit Hartmetalleinsätzen
With Hard Metal Inserts
Con punte in metallo duro
Con puntas de metal duro
Avec mors en métal dur

○ Max Ø 2.0 mm (.078")

Für weichen Draht
For soft Wire
Per filo leggero
Para alambre blando
Pour fil léger

○ Max Ø 1.5 mm (.059")

Für harten Draht
For hard Wire
Per filo duro
Para alambre duro
Pour fil dur

LX-103
170 mm

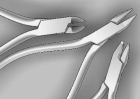

Scheren für dünne Stahl-und Edelmetallbleche - Scissors for thin steel and precious metal sheets
 Forbici per lamine sottili di acciaio e metalli preziosi - Tijeras para láminas delgadas de acero y metales preciosos
 Ciseaux pour couper les feuilles de métaux

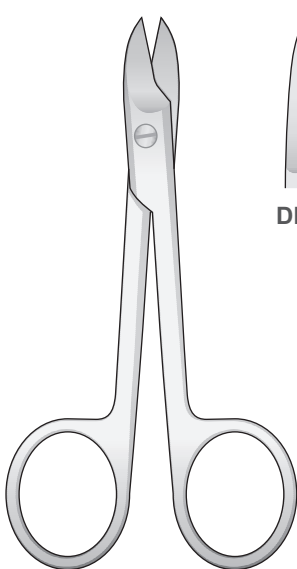

BEEBE
DP-91/DP-92
 110 mm

Spitz
 Sharp
 Acute
 Agudas
 Pointu

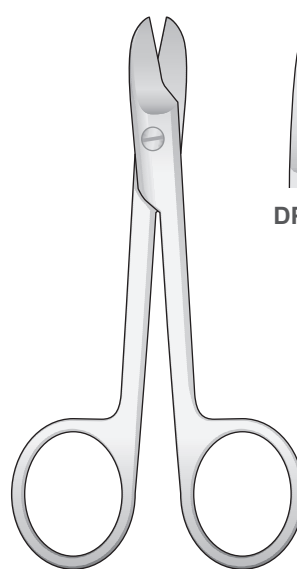
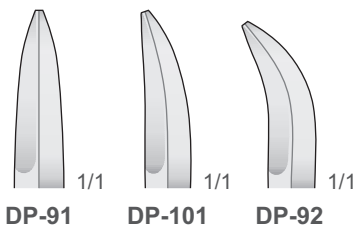

BEEBE
DP-102/DP-103
 110 mm

Stumpf
 Blunt
 Smusse
 Romas
 Mousse

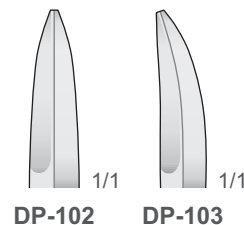

Scheren für dünne Stahl-und Edelmetallbleche - Scissors for thin steel and precious metal sheets
 Forbici per lamine sottili di acciaio e metalli preziosi - Tijeras para láminas delgadas de acero y metales preciosos
 Ciseaux pour couper les feuilles de métaux

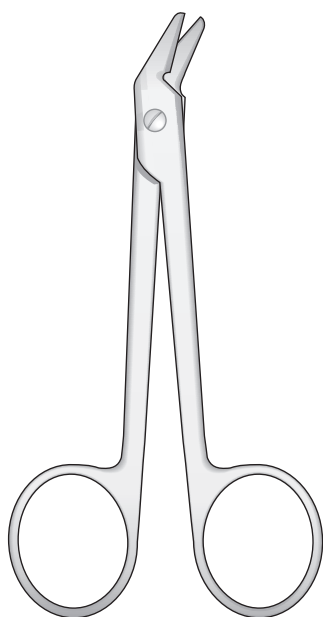

DP-90
 120 mm

Draht-und Blechscherre gezahnt
 Wire cutting scissor serrated
 Forbice universale dentellata
 Tijeras para cortar hilo
 de acero dentadas
 Coupe-fils dentelé

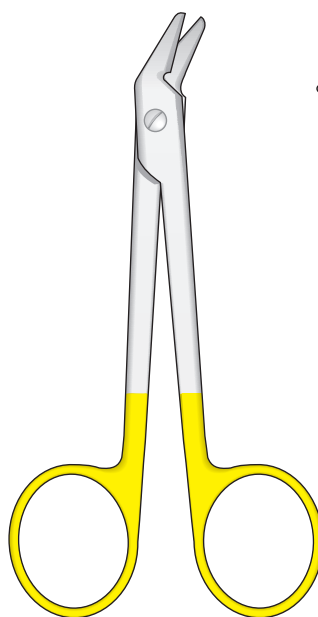
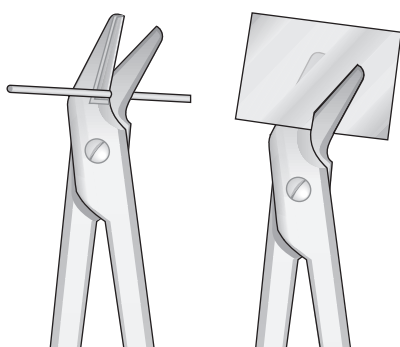

DP-120
 120 mm

Für weichen Draht
 For soft Wire
 Per filo leggero
 Para alambre blando
 Pour fil léger

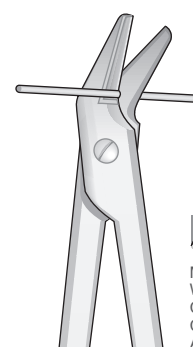

Mit Hartmetalleinsätzen
 With Hard Metal Inserts
 Con punte in metallo duro
 Con puntas de metal duro
 Avec mors en métal dur

○ Max Ø 1.2 mm (.048")



Separierzangen
Separating Pliers
Pinze tendielastici
Pinza estira-elásticos
Pince à separer

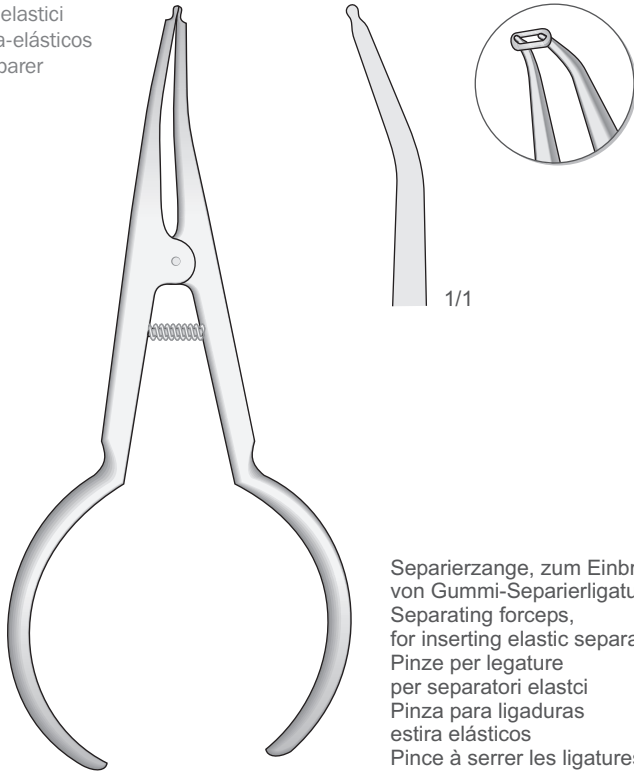

Separierzange, zum Einbringen von Gummi-Separierligaturen
Separating forceps, for inserting elastic separators
Pinze per legature per separatori elastci
Pinza para ligaduras estira elásticos
Pince à serrer les ligatures

DF-20
155 mm

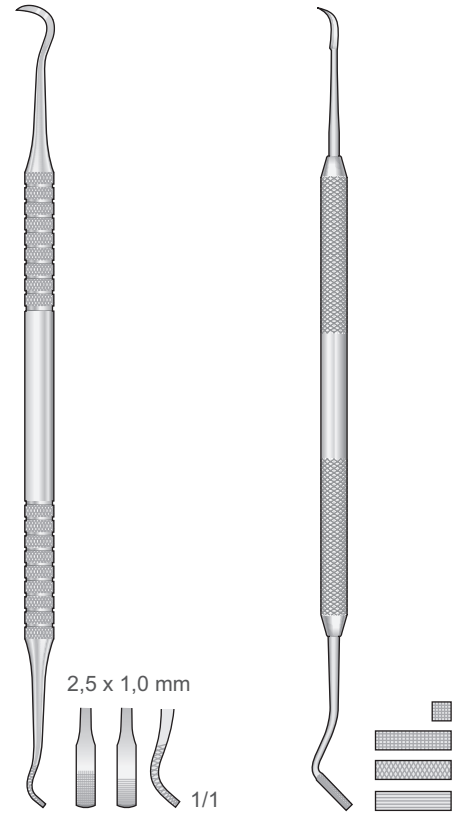

2,5 x 1,0 mm

SHURE DP-124
175 mm

DP-54
175 mm

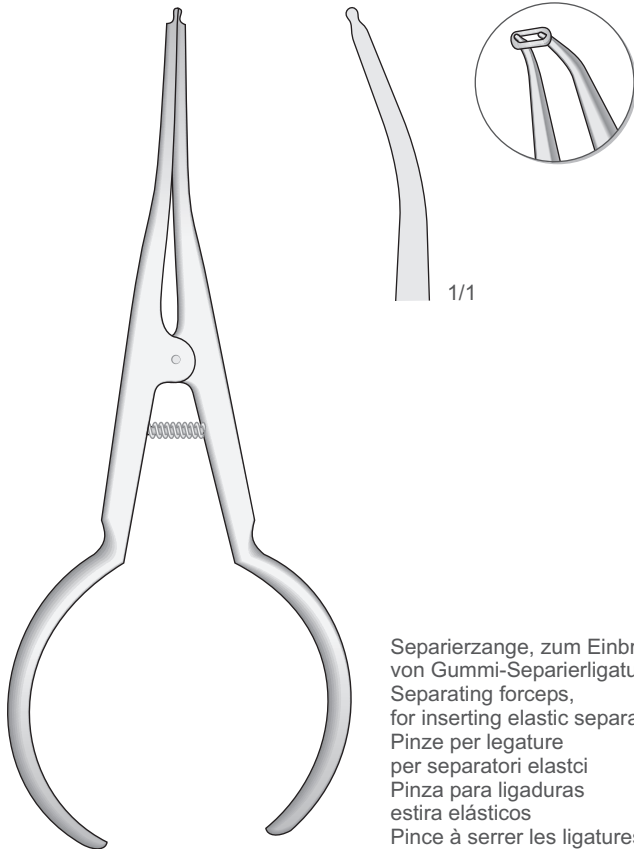

Separierzange, zum Einbringen von Gummi-Separierligaturen
Separating forceps, for inserting elastic separators
Pinze per legature per separatori elastci
Pinza para ligaduras estira elásticos
Pince à serrer les ligatures

DF-21
170 mm

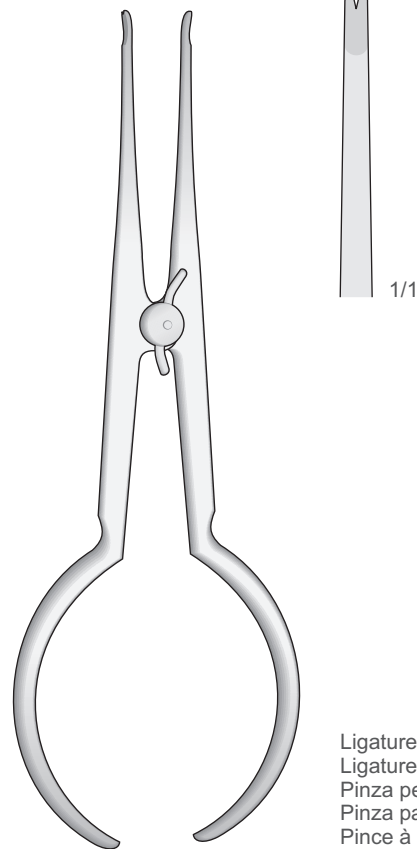

Ligaturenspannzange
Ligature Tying Plier
Pinza per legature
Pinza para ligaduras
Pince à serrer les ligatures

DF-50
170 mm



Utility Instrumente
 Utility Instruments
 Strumenti di utilità
 Instrumentos para utilidad
 Instruments pour utility

Bandandrücker
 Band Pusher
 Spingibande
 in acciaio inox
 Empujador de bandas
 Instruments pour
 poser les bagues

Con punta dentellata

In alluminio
 leggero anodizzato

Bracketpositioner
 Bracket Positioning Gauge
 Posizionatore per
 attacchi D.B. Posteriori
 Posicionador de Brackets
 Jauge à Brackets

DP-100
170 mm

**MERSHON
 DP-50**
140 mm

Direzionatori
 di legature

Ligaturen-Setzer
 Twirl on instrument
 Applicatore per
 legature elastiche
 Instrumentos para
 aplicar las ligaduras
 Instrument pour
 appliquer
 les ligatures

DP-125
155 mm

PF-1
170 mm

PF-2
170 mm

PF-3
160 mm



Ligatureinstrumente
Ligating Instruments
Strumenti per legature
Instrumentos para ligaduras
Instruments à ligature

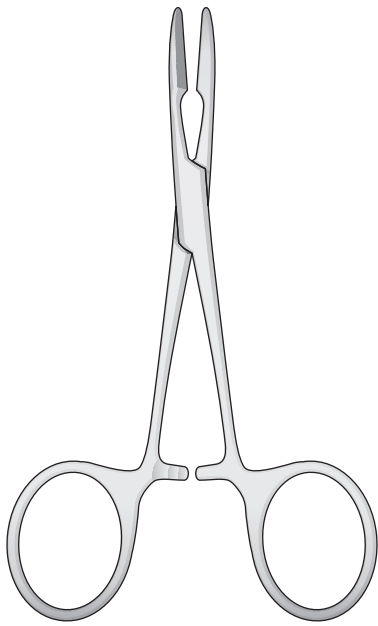

PEAN-MURPHY
BF-22
130 mm

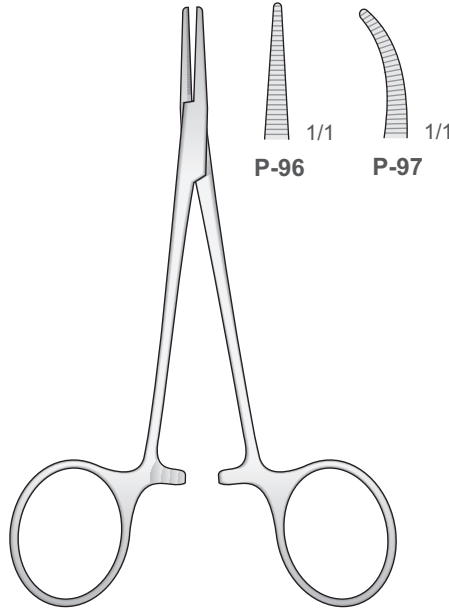

HALSTED-MOSQUITO
P-96/P-97
120 mm



COLLEGE
150 mm



MILLER
DR-78
145 mm

Bracketset Pinzette - Forceps for positioning Brackets
Pinzette per riposizionare gli attacchi diretti
(posizionamento dei Bracket)
Pinza para colocar Brackets - Précelle pour positionner les Brackets

Bracket Gauge
Rostfrei - Inox
Acciaio temperato
Acero temperado
Acer



DP-132
130 mm



DP-133
130 mm



DP-52
130 mm



DP-126
110 mm

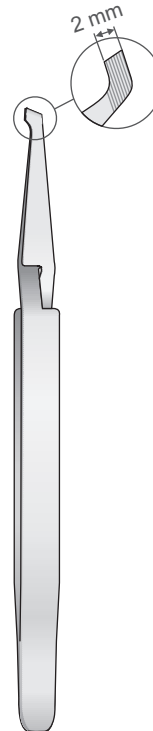

DP-127
125 mm



DP-128
145 mm

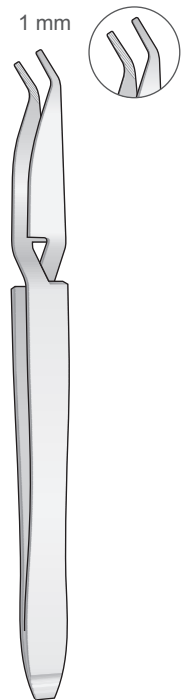

DP-129
130 mm

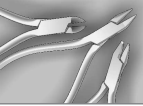

Meßinstrumente
 Measuring Instruments
 Strumenti per misura
 Instrumentos para medir
 Instruments à mesurer

Dental-Schieblehre für Praxis und Labor
 Gauge Caliper for practice and laboratory
 Calibri dentali per studio e laboratorio
 Calibrador dental para el gabinete y el laboratorio
 Gauge calibreur pour cabinet et laboratoire

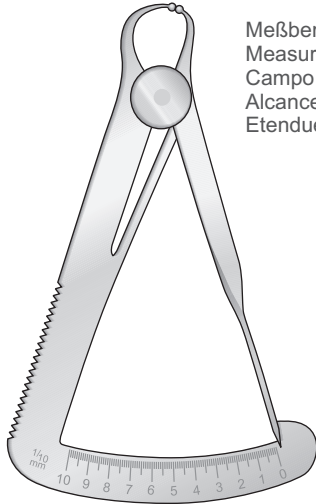

Meßbereich: 0 - 10 mm
 Measuring range: 0 - 10 mm
 Campo di misura: 0 - 10 mm
 Alcance de medición: 0 - 10 mm
 Etendue de mesure: 0 - 10 mm

**IWANSON
 DP-721**
 100 mm

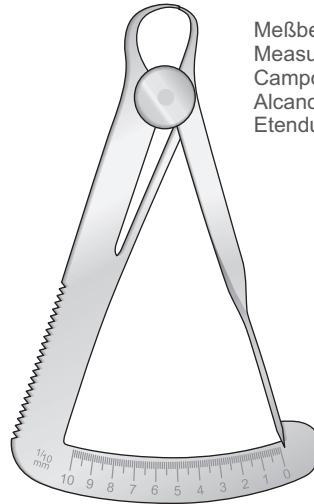

Meßbereich: 0 - 10 mm
 Measuring range: 0 - 10 mm
 Campo di misura: 0 - 10 mm
 Alcance de medición: 0 - 10 mm
 Etendue de mesure: 0 - 10 mm

**IWANSON
 DP-720**
 100 mm

Meßbereich: 0 - 100 mm
 Measuring range: 0 - 100 mm
 Campo di misura: 0 - 100 mm
 Alcance de medición: 0 - 100 mm
 Etendue de mesure: 0 - 100 mm

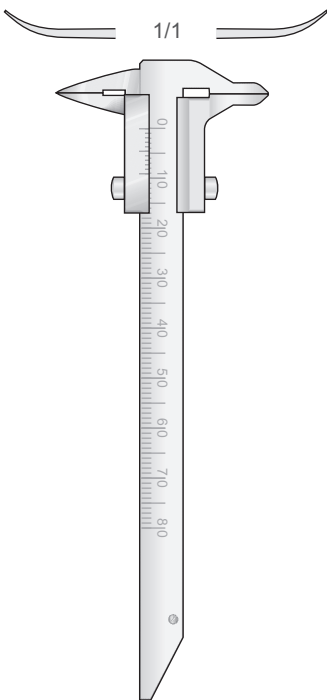

DP-723
 80 mm

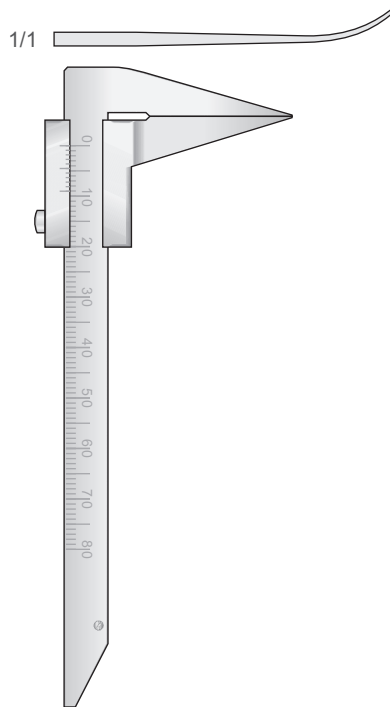

DP-724
 80 mm

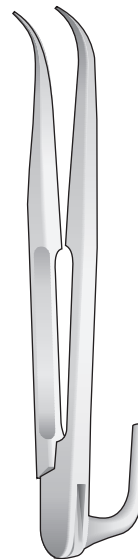

**ZIELINSKY
 DP-725**
 110 mm

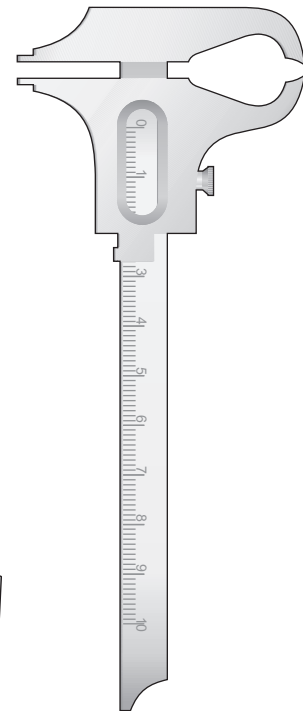

**BOLEY
 DP-730**
 140 mm



Zubehör
Accessories
Accessori
Accesorios
Accessoires

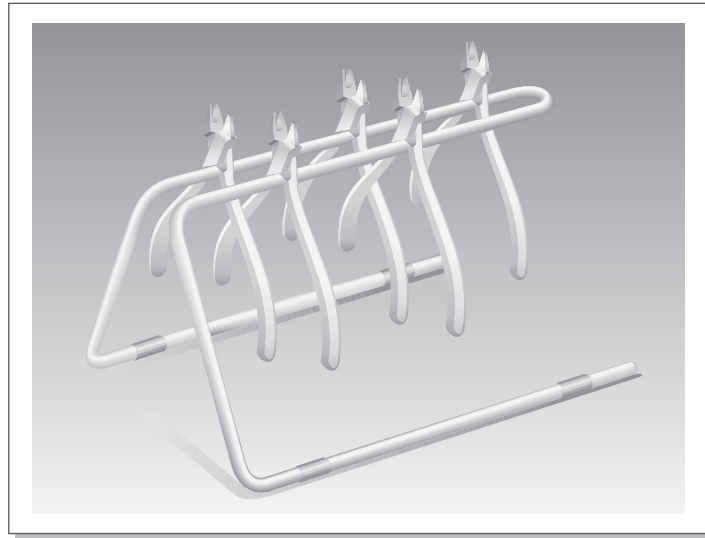

Zangenständer
Plier Stand
Supporto per pinze
Soportes para alicates
Supports de pinces

Rostfrei - Stainless Steel
Acciaio Inox - Acero - Acier

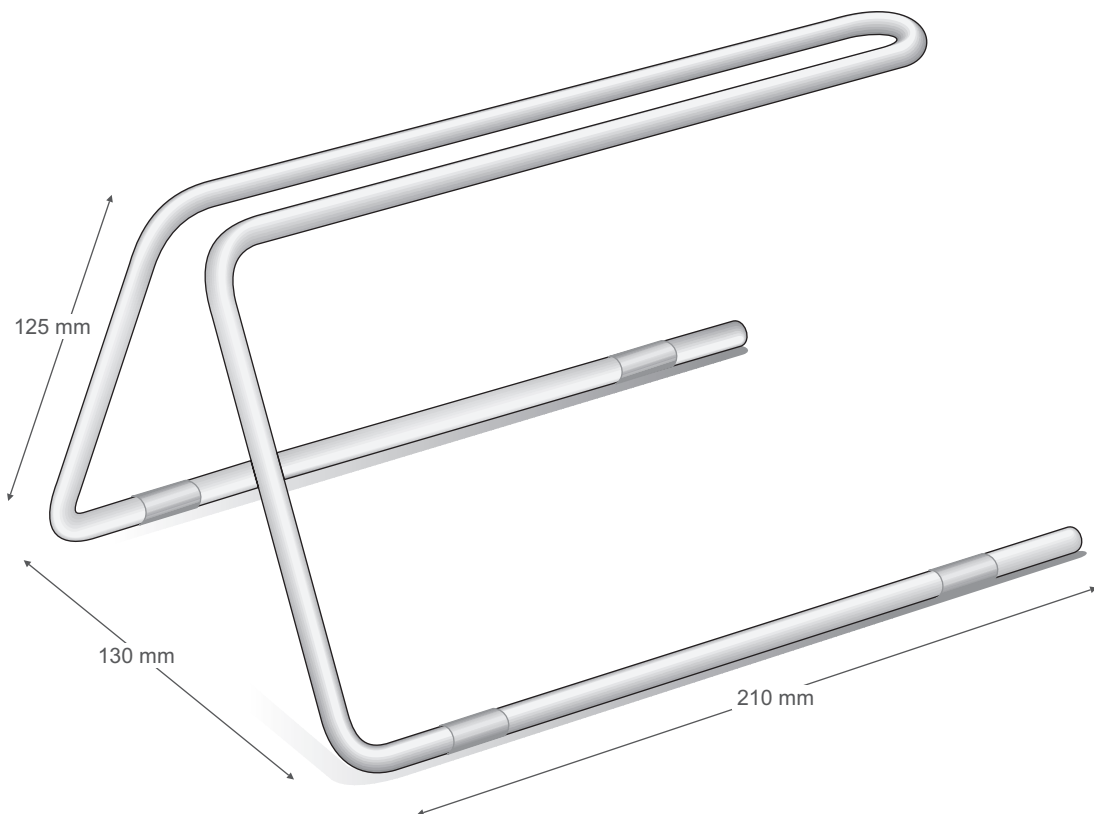

DP-140

.14

Kroneninstrumente und Labor
Crown Instruments and Laboratory
Strumenti per corone e laboratorio
Instrumentos para coronas y laboratorio
Instruments à couronnes et laboratoire

Zahnärztliche Chirurgie
Dental surgery
Chirurgia dentale
Cirugia dental
Chirurgie dentaire



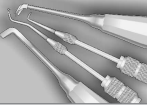

Kroneninstrumente
Crown Instruments
Pinze per corone
Alicates para coronas
Pinces à couronnes

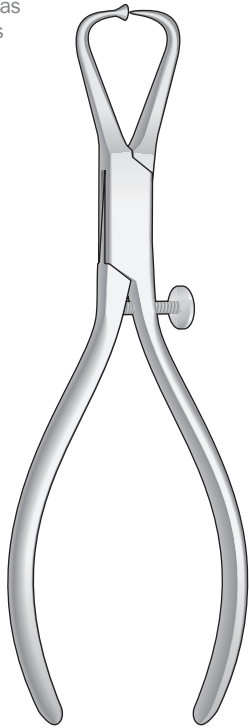

Kupferringabnehmezange
Copper ring removing Pliers
Pinza per togliere anelli di rame
Pinza para sacar anillos de cobre
Pince à enlever les bagues en cuivre

KERLING
DP-38A
145 mm

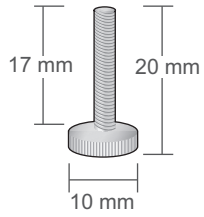
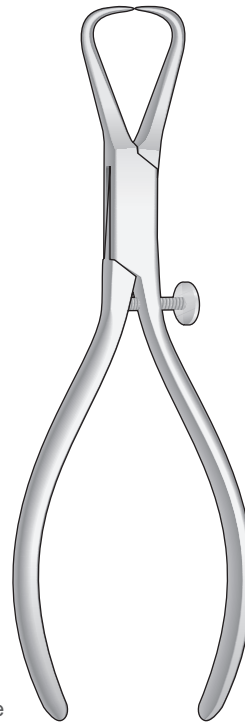

DP-38R
Schraube
Replacement Screw
Vite di ricambio
Tornillos de recambio
Rechange

Kupferringabnehmezange
Copper ring removing Pliers
Pinza per togliere anelli di rame
Pinza para sacar anillos de cobre
Pince à enlever les bagues en cuivre

FURRER
DP-38
145 mm

Teleskopkronenzangen - Pliers for telescope crowns
Pinze per corone telescopiche - Alicates para coronas telescópicas
Pinces pour couronnes telescopes

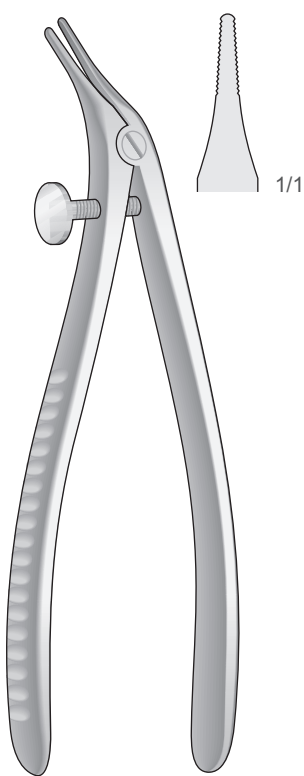

BÖHM
DP-28
150 mm

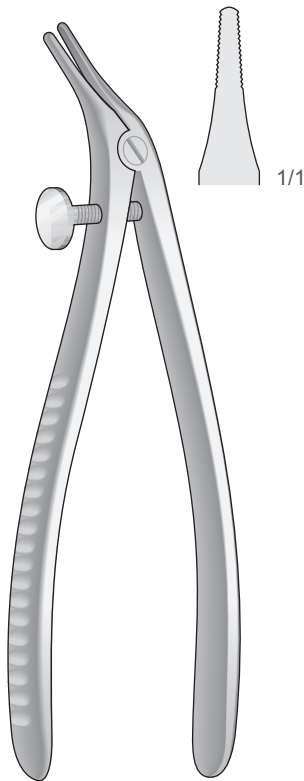

BÖHM
DP-29
150 mm

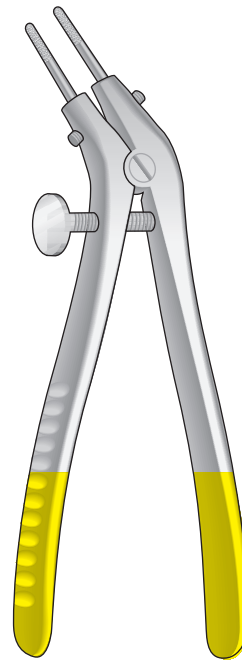

DP-24
120 mm



DP-24C
Schlüssel
Key
Chiavetta
Llave
Clé



DP-24R
Diamantierte Einsätze, paarweise
Diamond inserts, in pairs
Coppia di punte diamantate
Puntas diamantadas, a pares
Pointes diamantées, par paires

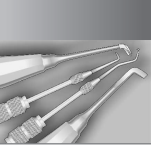

MRT/C7

Bridge - Extractor complete set
consisting of:
MRT-7, C-71, C-72, C-73, C-74

Martelletto togliiponti completo di:
MRT-7, C-71, C-72, C-73, C-74

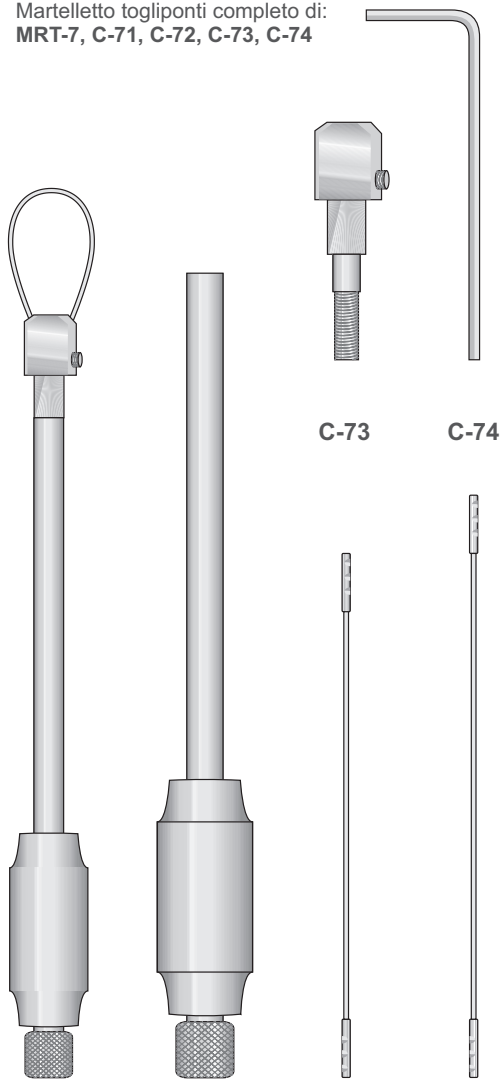

MRT/C7

MRT-7

C-71
70 mm

C-72
80 mm

Kronenabnehmer
Removing pliers
for temporary
bridges and crowns
Levacorone
Scador de coronas
Arrache couronne

TC

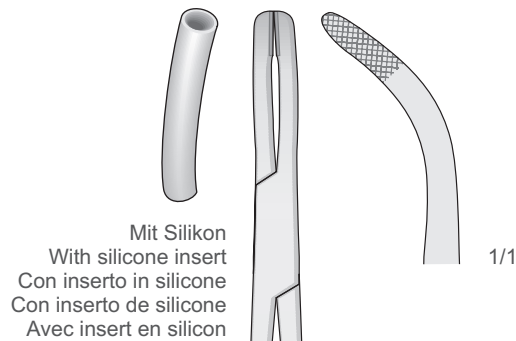

Mit Silikon
With silicone insert
Con inserto in silicone
Con inserto de silicone
Avec insert en silicon

1/1

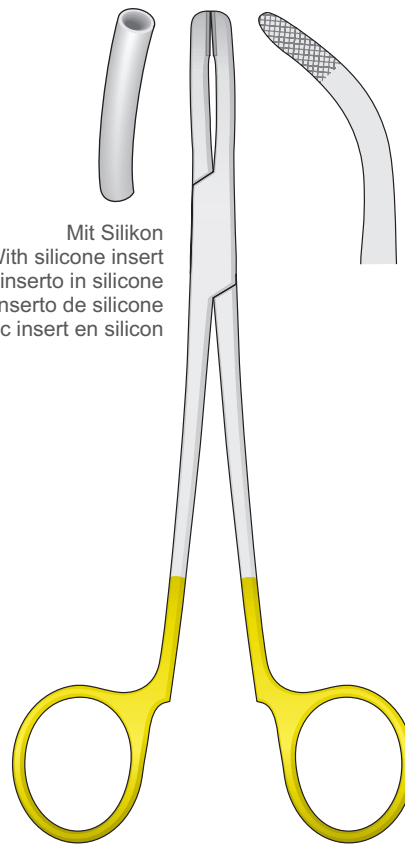

PH-60
170 mm

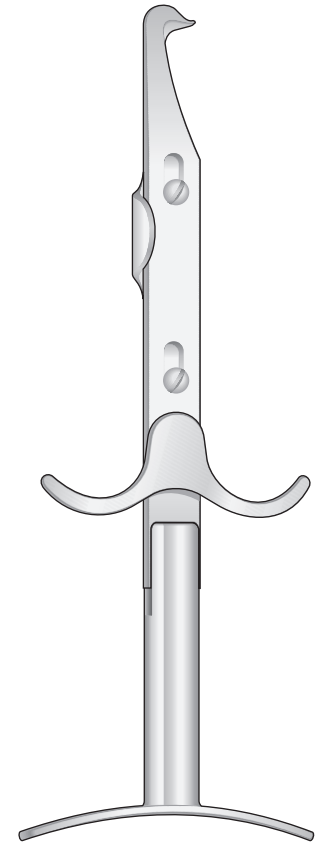

MRT-6
170 mm

Kronenentferner
Crown Removers
Martelletti levacorone
Arranca coronas
Arrache couronnes

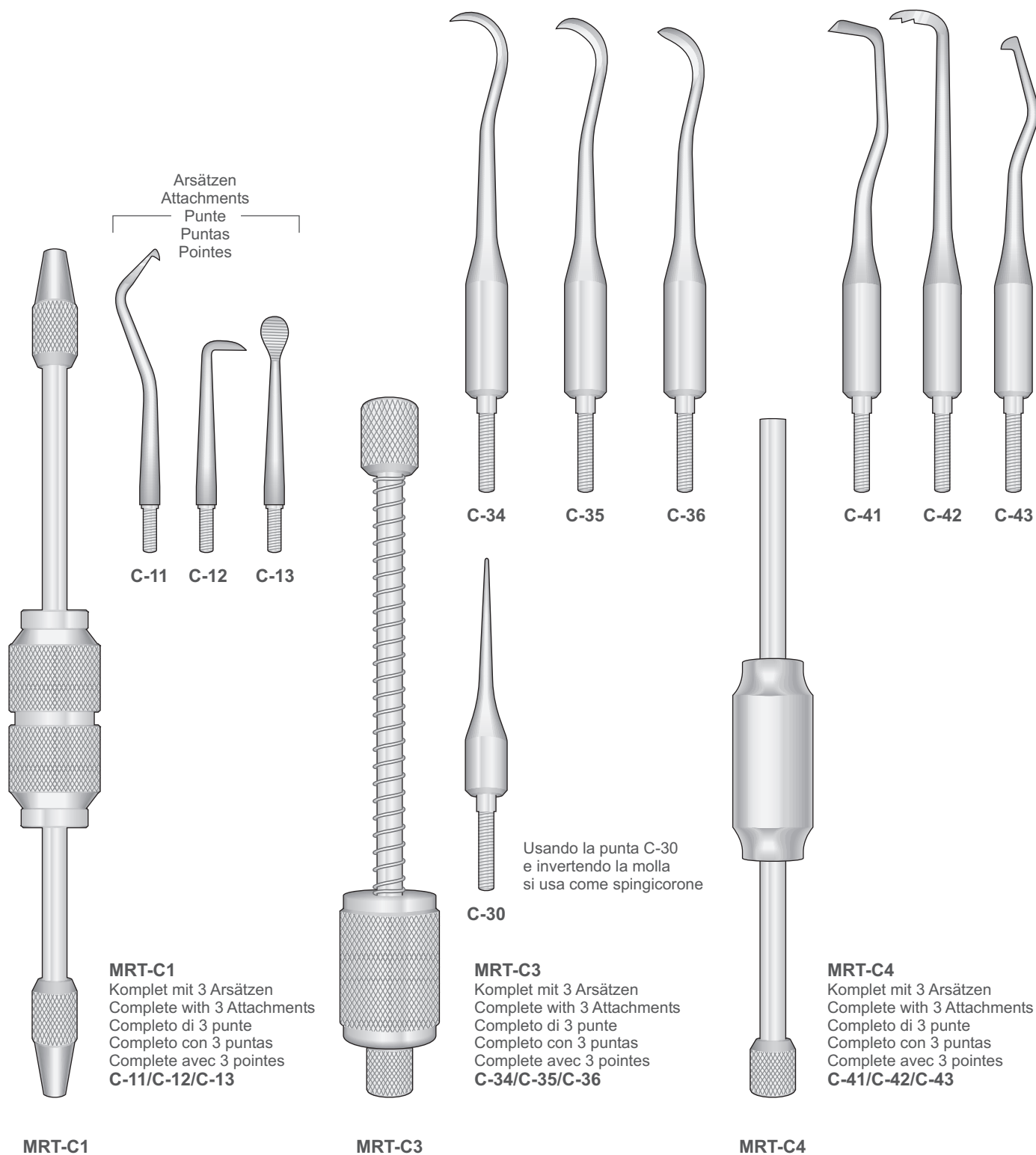
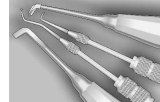

Arsätzen
Attachments
Punte
Puntas
Pointes

C-11 C-12 C-13

C-34 C-35 C-36 C-41 C-42 C-43

C-30

Usando la punta C-30
e invertendo la molla
si usa come spingicorone

MRT-C1
Komplet mit 3 Arsätzen
Complete with 3 Attachments
Completo di 3 punte
Completo con 3 puntas
Complete avec 3 pointes
C-11/C-12/C-13

MRT-C3
Komplet mit 3 Arsätzen
Complete with 3 Attachments
Completo di 3 punte
Completo con 3 puntas
Complete avec 3 pointes
C-34/C-35/C-36

MRT-C4
Komplet mit 3 Arsätzen
Complete with 3 Attachments
Completo di 3 punte
Completo con 3 puntas
Complete avec 3 pointes
C-41/C-42/C-43

MRT-C1

MRT-C3

MRT-C4

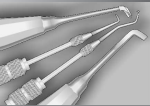

Kronenabnehmer
Crown removers
Levacorone
Instrumentos para quitar coronas
Instruments à détacher les couronnes



DL-C
140 mm



DL-V
130 mm



DL-0
130 mm



**UNIVERSAL
DL-60**
150 mm

Replacement Kit Consisting of 10 couples
Plastic-Polymer Tips and 10 g. Powder Adhesive
Kit di ricambio con 10 coppie di inserti
in plastica e 10 gr. di polvere adesiva

Powder adhesive
Polvere adesiva
10 gr.

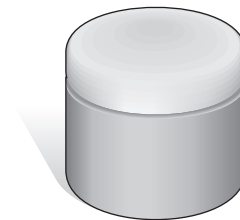

10 Couples
10 Coppie



DP-137

Kronenaufweitzange
Crown extraction pliers with
interchangeable plastic tips
Pinza per corone

DP-136

Set consisting of 1 ea. Crown-tractor
and 10 Plastic-Polymer tips, and 10g. Powder Adhesive
Set completo di pinza per corone,
10 coppie di inserti in plastica e 10 gr. di polvere adesiva

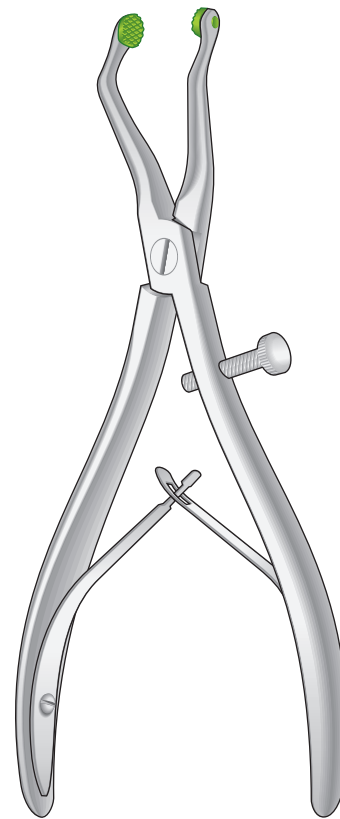

DP-136
140 mm



Wachsmesser
Wax Knives
Coltelli per cera
Cuchillos para cera
Couteaux à cire



**FAHNENSTOCK
CP**

**FAHNENSTOCK
CG**

**LESSMANN
CPL**

**LESSMANN
CGL**

CPS

CGS



Spatel
Spatulas
Spatole
Espátulas
Spatules

Spatulas for plaster and alginate
Spatole per alginato e gesso

Biegsam
Flexible
Flessibili
Flexibles
Flexibles

Spatel Inox
Spatulas Inox - Rigid
Spatola Inox - Rigida



GRITMAN
CM
175 mm



SA-1
200 mm



SA-2
200 mm



SA-3
200 mm

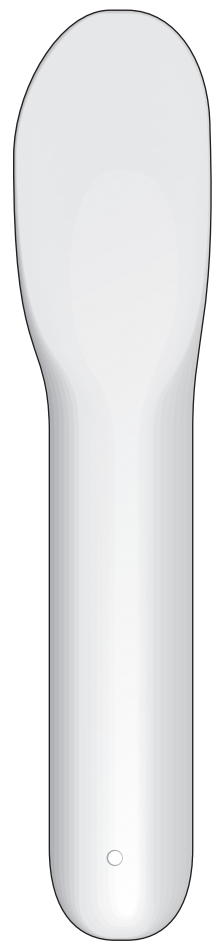

S18-8
185 mm

Instrumente für Labor
Instruments for laboratory
Strumenti da laboratorio
Instrumentos para laboratorio
Instruments pour laboratoire

Runder Hohlgriff 8 mm
Hollow Round Handle 8 mm
Manico tondo vuoto 8 mm
Mango hueco 8 mm
Manche rond vide 8 mm

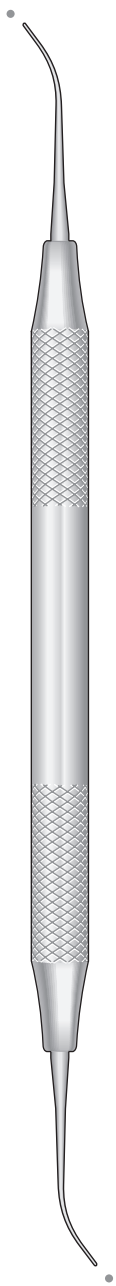
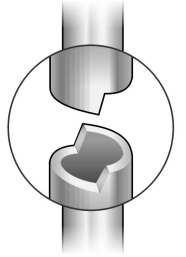

P.K. THOMAS
751-121
165 mm

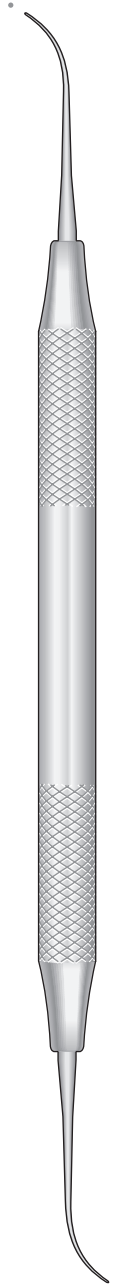

P.K. THOMAS
751-122
165 mm

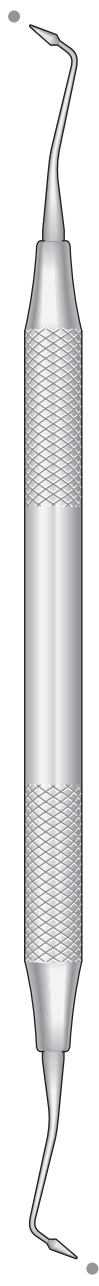

P.K. THOMAS
751-123
165 mm

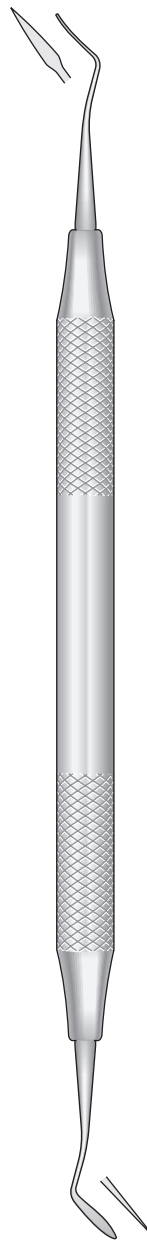

P.K. THOMAS
751-124
165 mm

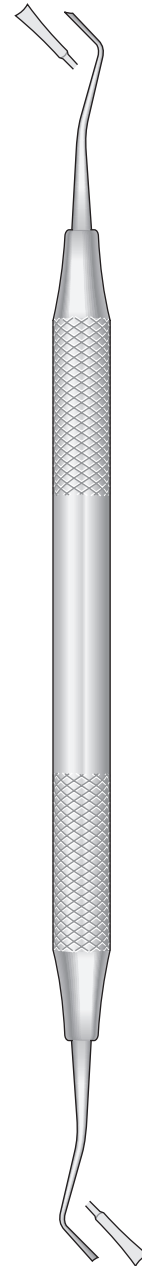

P.K. THOMAS
751-125
165 mm

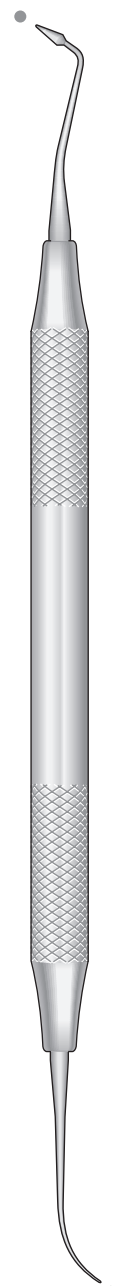

P.K. THOMAS
751-2/3
165 mm



Instrumente für Labor
Instruments for laboratory
Strumenti da laboratorio
Instrumentos para laboratorio
Instruments pour laboratoire

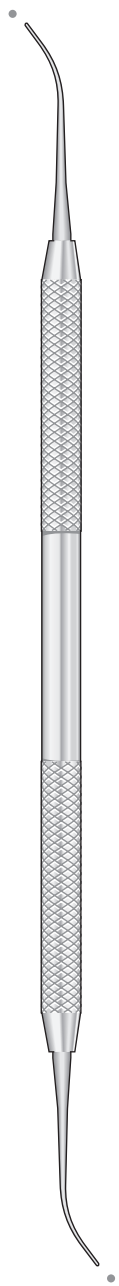

P.K. THOMAS
PT-1
165 mm

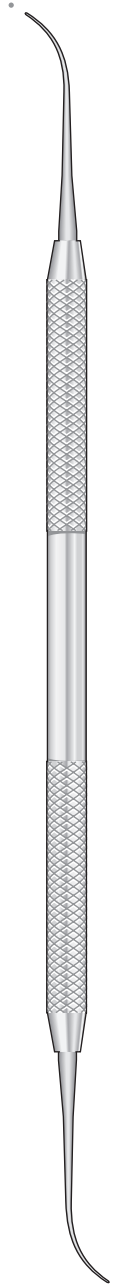

P.K. THOMAS
PT-2
165 mm

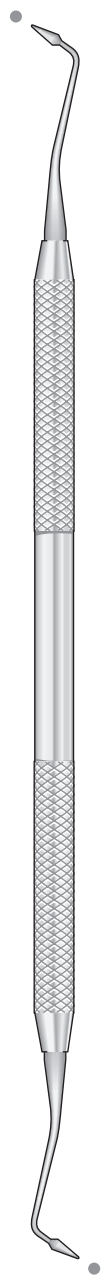

P.K. THOMAS
PT-3
165 mm

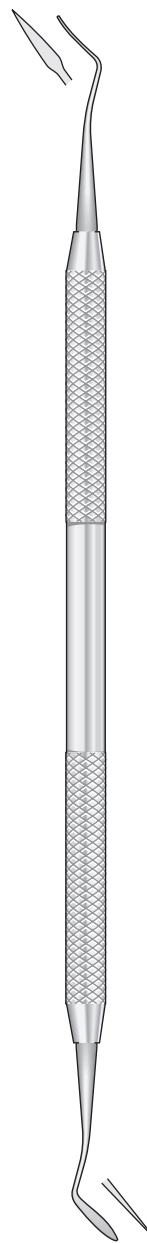

P.K. THOMAS
PT-4
165 mm

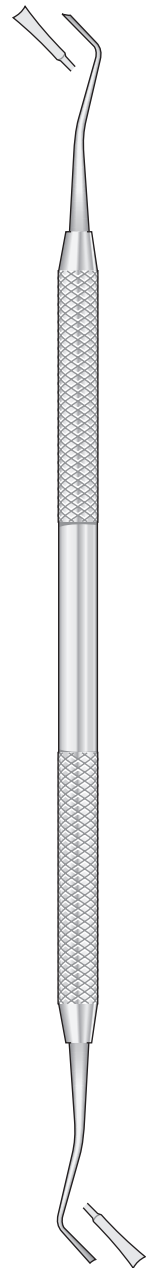

P.K. THOMAS
PT-5
165 mm

Instrumente für Labor
Instruments for laboratory
Strumenti da laboratorio
Instrumentos para laboratorio
Instruments pour laboratoire

Alu
Aluminium
Alluminio
Aluminium
Aluminio

Runder Hohlgriff 8 mm
Hollow Round Handle 8 mm
Manico tondo vuoto 8 mm
Mango hueco 8 mm
Manche rond vide 8 mm

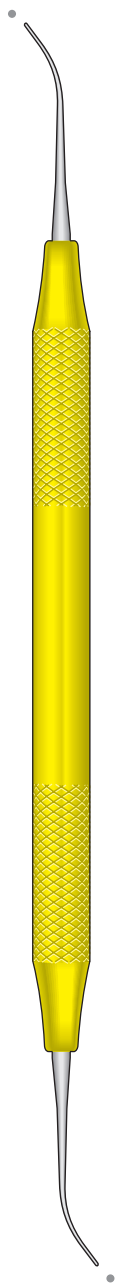
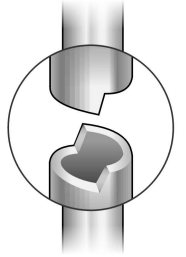

P.K. THOMAS
AL-PT1
165 mm



P.K. THOMAS
AL-PT2
165 mm

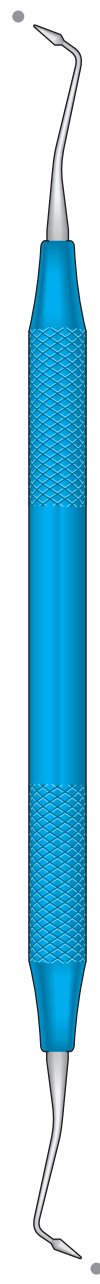

P.K. THOMAS
AL-PT3
165 mm

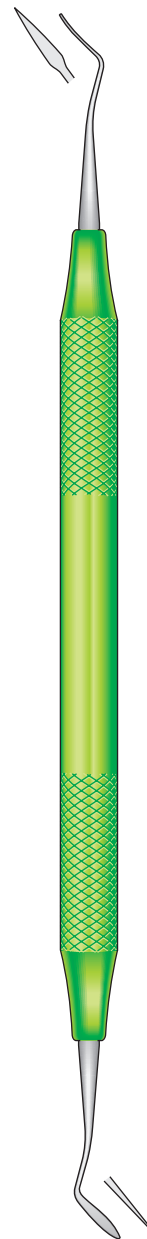

P.K. THOMAS
AL-PT4
165 mm

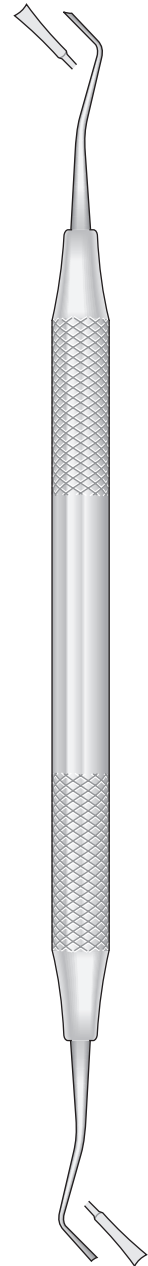

P.K. THOMAS
AL-PT5
165 mm

Modellierinstrumente für Keramik
 Ceramic sculpturing instruments
 Strumenti per ceramica
 Instrumentos para modelar la ceramica
 Instruments à modeler la céramique

Alu
Aluminium
Alluminio
Aluminium
Aluminio

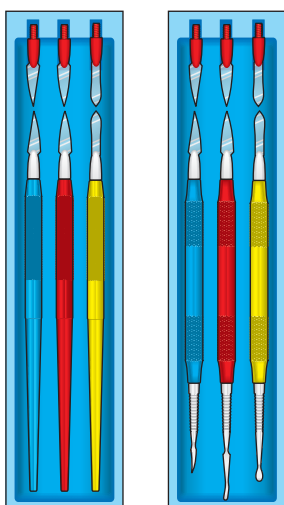

Biegsam - Flexible
 Flessibili - Flexibles
 Flexibles

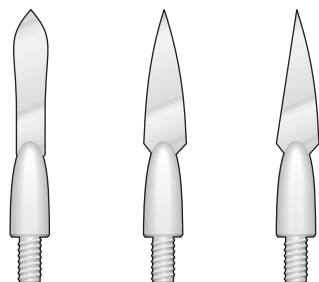

CL-1B CL-2B CL-3B

Superbiegsam - Superflexible
 Superflessibili - Superflexibles
 Superflexibles

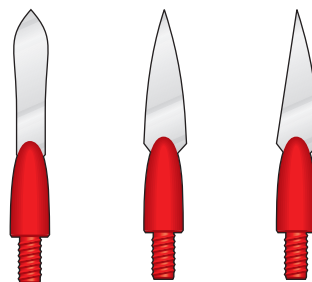

CL-1R CL-2R CL-3R

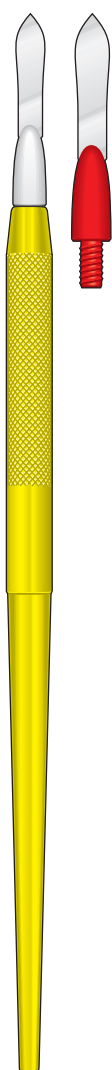

AL-SETC/1

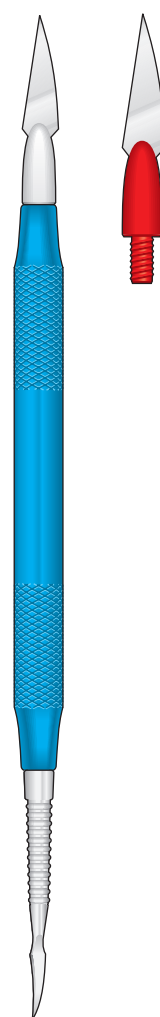
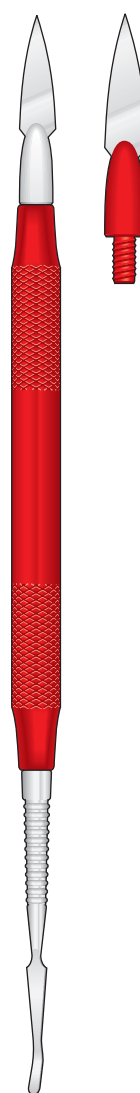
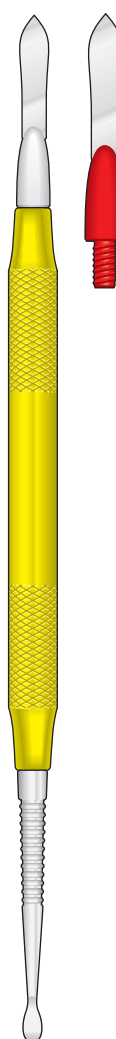

AL-SETC/2

Instrumente für Labor
Instruments for laboratory
Strumenti da laboratorio
Instrumentos para laboratorio
Instruments pour laboratoire

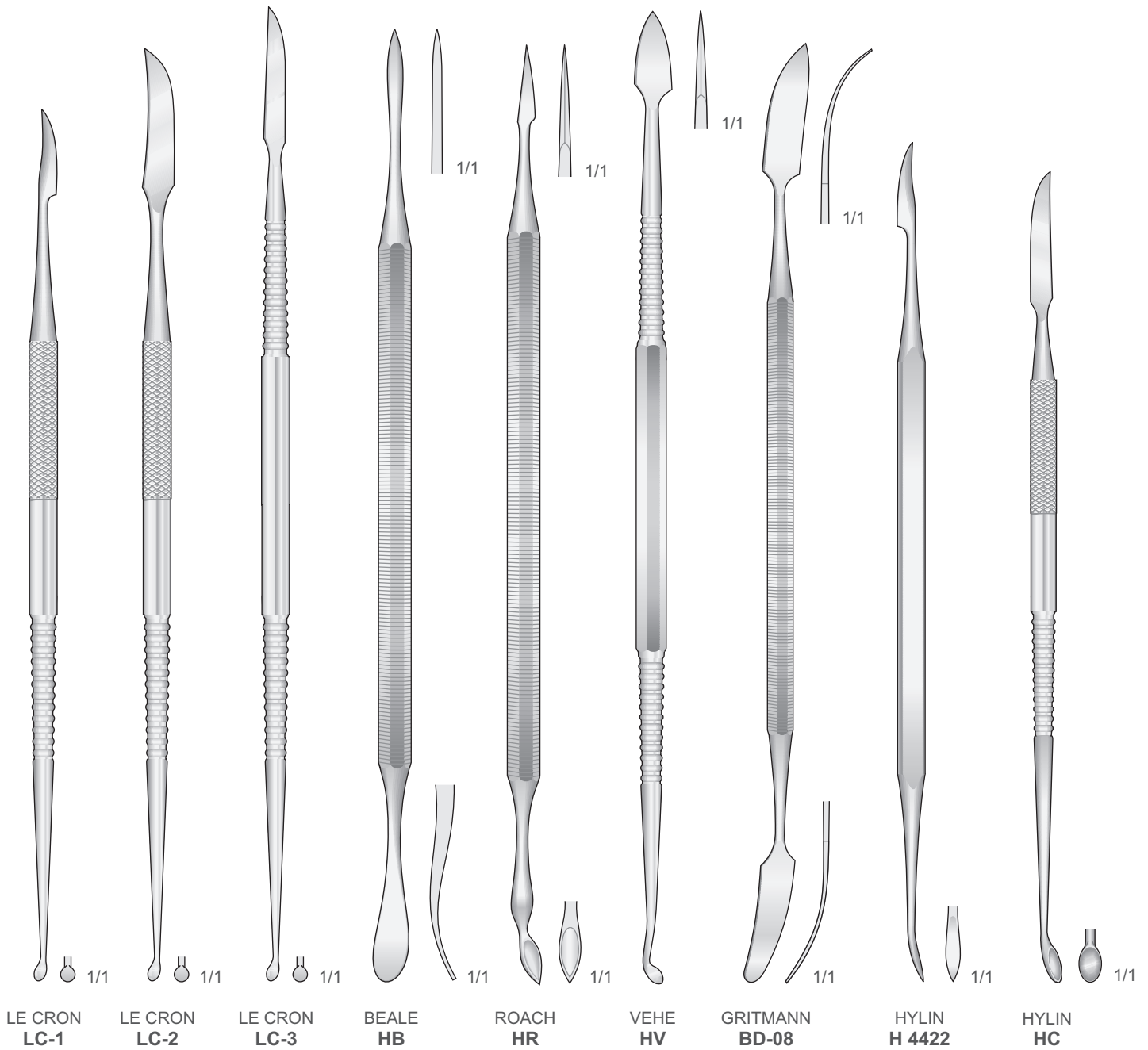

.15

Erhaltung für instrumente, Sterilisieretuis
Maintening of instruments, Sterilizing Boxes
Mantenimento strumenti, Scatole per sterilizzazione
Mantenimiento del instrumental, Estuches de esterilización
Nettoyage d'instruments, Etais de stérilisation

Zahnärztliche Chirurgie
Dental surgery
Chirurgia dentale
Cirugia dental
Chirurgie dentaire





Gefäße aus Edelstahl
Stainless Steel Receptacles
Recipienti in acciaio inossidabile
Recipientes de acero inoxidable
Réceptientes en acier inoxydable

Nadeldose
Needle case
Scatola per aghi
Caja para agujas
Boite à aiguilles

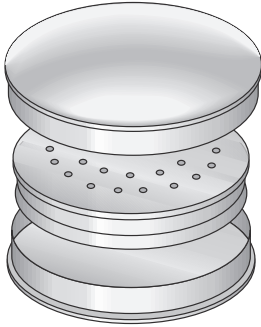

BS-1
Ø 78 mm h 15 mm

Nierenschalen
Kidney bowls
Bacinelle reniformi
Riñoneras
Bassins réniformes



BR-20 200 mm
BR-25 250 mm
BR-28 280 mm

Verbandstoffrommeln
Dressing sterilizing drums
Cestelli cilindrici
Cajas para esterilizacion
Boites à stérilisation

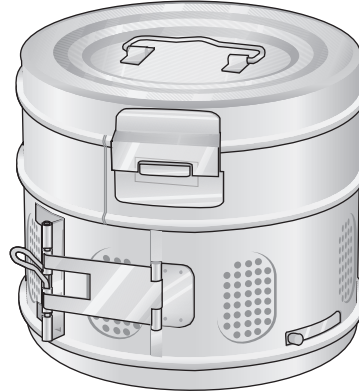

CS-12 125x125 mm
CS-15 150x150 mm
CS-19 190x145 mm

Runder Sterilbehälter mit Ausguss
Lotion bowls capsules
Capsule inox con fondo piano e becco
Cubetas de acero inoxidable
Cuvettes de acier inoxydable

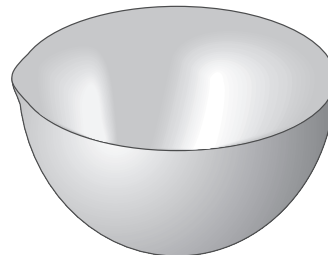

CS-01 Ø 40 mm 15 cc
CS-02 Ø 60 mm 75 cc
CS-03 Ø 80 mm 225 cc
CS-04 Ø 100 mm 325 cc
CS-05 Ø 120 mm 500 cc

Gefäße
Receptacles
Recipiente
Recipientes
Réceptientes

Mit 7 box
With 7 box
Con 7 box
Con 7 box
Avec 7 box



BS-32
180 x 85 x 20 mm

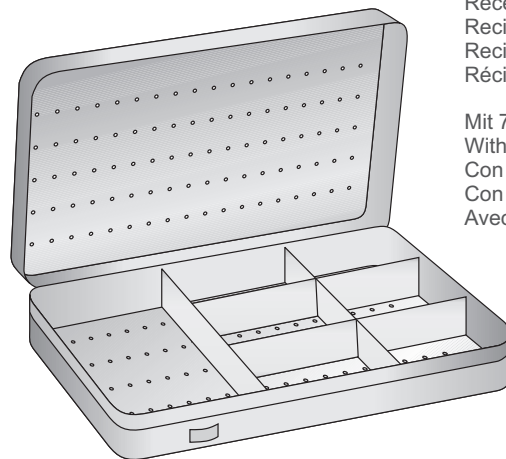

BS-27
150 x 90 x 20 mm



Steril Container
Sterilizing containers
Contenitori per sterilizzare
Contenedores para esterilización
Containers pour stériliser

Schalen
Trays
Vassoi porta-strumenti
Bandejas
Bassins

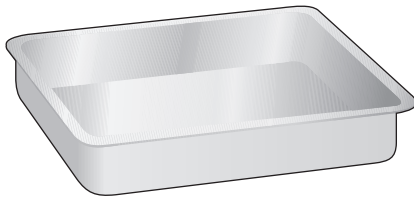

VS-20 210 x 110 x 25 mm
VS-26 250 x 180 x 30 mm
VS-30 300 x 220 x 30 mm

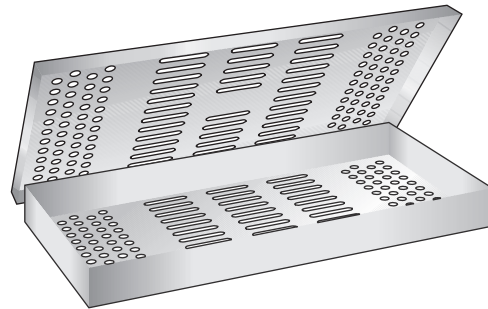

BS-41
275 x 130 x 25 mm

Mit Instrumentehalter und box
With Insert frames and box
Con griglia e scomparti
Con porta instrumentos y box
Avec Porte instruments et box

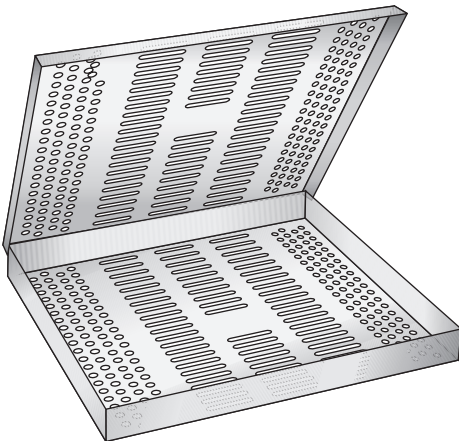

BS-43
285 x 190 x 25 mm

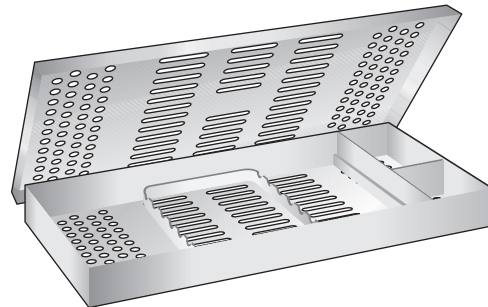

BS-40 275x130x25mm
BS-42 285x190x25mm

Silikonmatte
Matte en silicone
Tappeti in aghi di silicone
Tapete en agujas de silicona
Tapis en Silicone

Sterilisierbar
Autoclavable
Autoclavabili

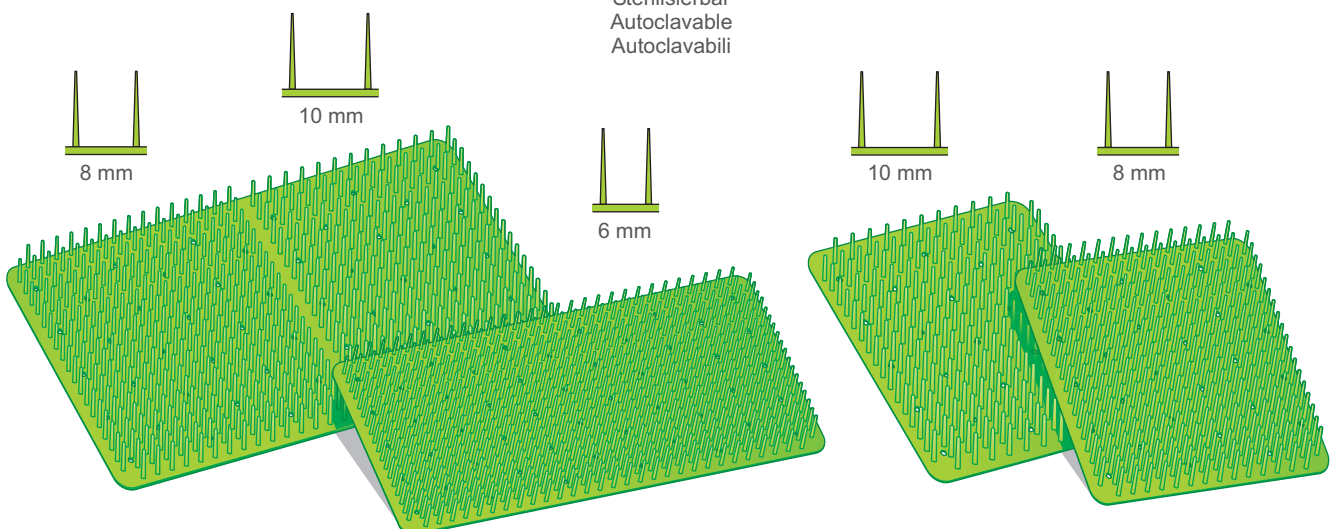

TS-104
270 x 180 mm

TS-103
260 x 120 mm

TS-102
135 x 180 mm

TS-101
135 x 180 mm



Dental Trays Container
Dental Trays Containers
Trays Contenitori per sterilizzare
Trays Contenedores para esterilización
Trays Containers pour stérilizer

Tray Inox mit Silikoneinrichtung - Stainless Steel Cassettes with Silicone Racks
Tray Inox con griglia in silicone - Recipientes de acero con equipo de silicona
Cassettes en acier avec aménagement en silicone

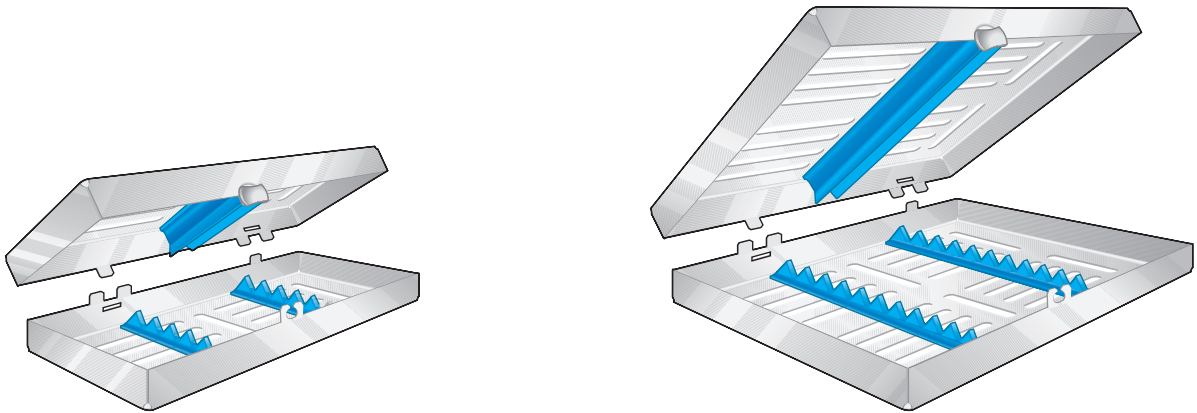

BS-59 Für 5 Instrumente
For 5 Instruments
Per 5 strumenti
Para 5 instrumentos
Pour 5 instruments
185 x 75 x 35 mm

BS-60 Für 10 Instrumente
For 10 Instruments
Per 10 strumenti
Para 10 instrumentos
Pour 10 instruments
185 x 135 x 35 mm

BS-61 Für 20 Instrumente
For 20 Instruments
Per 20 strumenti
Para 20 instrumentos
Pour 20 instruments
290 x 185 x 35 mm

CT-555
CT-560
CT-565



CT-651
CT-652
CT-653



Sterilcontainer,
mit Deckel- und Bodenperforation,
passend in gängige Praxisautoklaven
Containers for sterilization,
with perforation in lid and bottom,
suitable for common practice autoclaves
Contenitori dentali,
con coperchio e fondo perforato,
adatti a tutte le autoclavi comuni
Contenedores dentales,
con tapa perforada y fondo perforado,
aptos para autoclaves habituales
Containers stérile,
avec perforation du couvercle et du fond,
convenant aux autoclaves courants
pour cabinets médicaux

Silikoneinrichtung für Tray
Silicone Racks for Tray
Griglia in Silicone per Tray
Equipo de silicona para Tray
Aménagement en silicone pour Tray



CT-555
300 x 140 x 40 mm
CT-651
310 x 190 x 40 mm

CT-560
300 x 140 x 70 mm
CT-652
310 x 190 x 65 mm

CT-565
300 x 140 x 100 mm
CT-653
310 x 190 x 130 mm

Alu
Aluminium
Alluminio
Aluminio
Aluminium

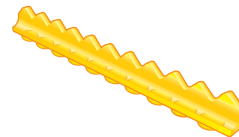

TRANSLUCENT YELLOW
SIL-01
130 mm

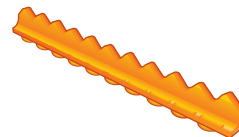

ORANGE
SIL-02
130 mm

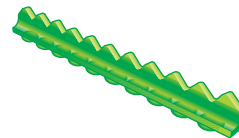

TRANSLUCENT GREEN
SIL-03
130 mm

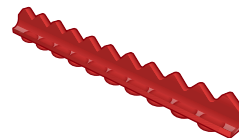

RUST RED
SIL-04
130 mm

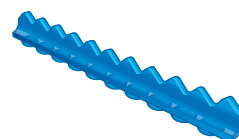

BLUE
SIL-05
130 mm

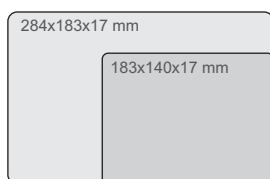

Farbcodiert-Tray-Unterteile für 17 instrumente
Color-Coded bases for 17 instruments
Vassoio colorati per 17 strumenti
Bandejas en colores para 17 instrumentos
Plateaux colorés pour 17 instruments

Für 17 instrumente
For 17 instruments
Per 17 strumenti
Para 17 instrumentos
Pour 17 instruments

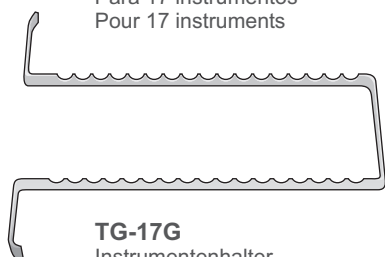

TG-17G
Instrumentenhalter
Insert frames
Griglia Portastrumenti
Porta instrumentos
Porte instruments



TG-17A
284x183x17 mm
Unterteile allein
Only base
Vassoio solo
Bandeja suelta
Plateau seul

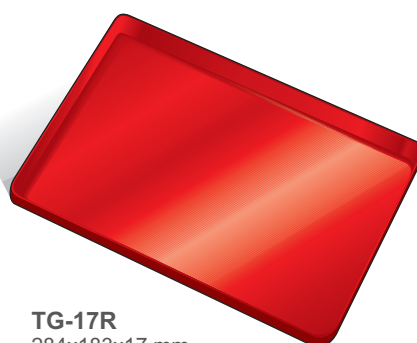

TG-17R
284x183x17 mm
Unterteile allein
Only base
Vassoio solo
Bandeja suelta
Plateau seul

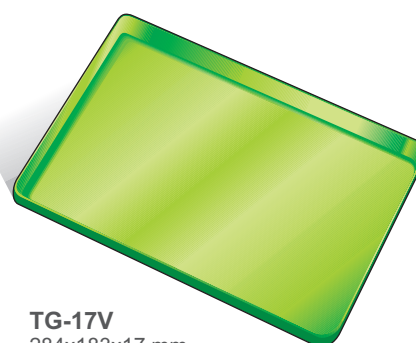

TG-17V
284x183x17 mm
Unterteile allein
Only base
Vassoio solo
Bandeja suelta
Plateau seul

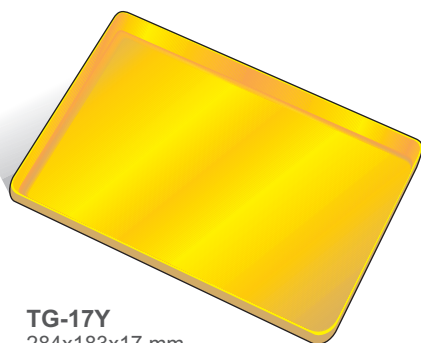

TG-17Y
284x183x17 mm
Unterteile allein
Only base
Vassoio solo
Bandeja suelta
Plateau seul

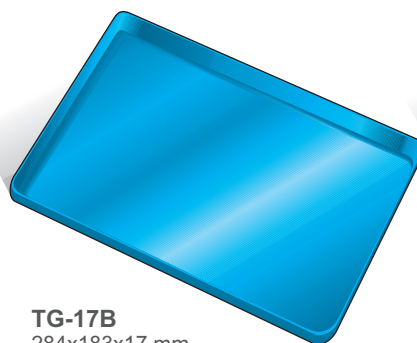

TG-17B
284x183x17 mm
Unterteile allein
Only base
Vassoio solo
Bandeja suelta
Plateau seul



TG-17C
288x187x29 mm
Tray-Deckel, grau
Lid - Grey only
Coperchio - Solo argento
Tapa en color gris
Couvercle - seulement en gris



Alu- MIDI Tray
Aluminium MIDI Trays
Tray in alluminio, misura MIDI
Bandejas de aluminio, tamaño MIDI
Bóites en aluminium, format MIDI

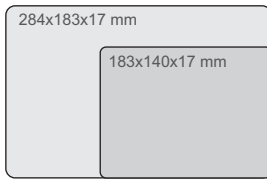

Farbcodiert-Tray-Unterteile für 8 instrumente
Color-Coded bases for 8 instruments
Vassoi colorati per 8 strumenti
Bandejas en colores para 8 instrumentos
Plateaux colorés pour 8 instruments

Für 8 instrumente
For 8 instruments
Per 8 strumenti
Para 8 instrumentos
Pour 8 instruments

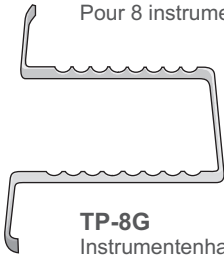

TP-8G
Instrumentenhalter
Insert frames
Griglia Portastrumenti
Porta instrumentos
Porte instruments



TP-8A
183x140x17 mm
Unterteile allein
Only base
Vassoio solo
Bandeja suelta
Plateau seul

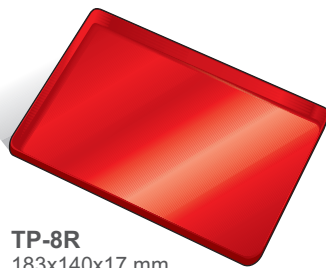

TP-8R
183x140x17 mm
Unterteile allein
Only base
Vassoio solo
Bandeja suelta
Plateau seul

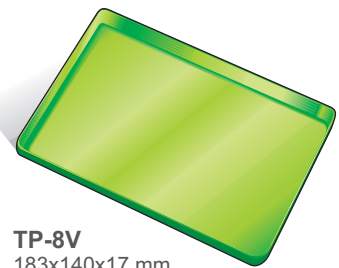

TP-8V
183x140x17 mm
Unterteile allein
Only base
Vassoio solo
Bandeja suelta
Plateau seul

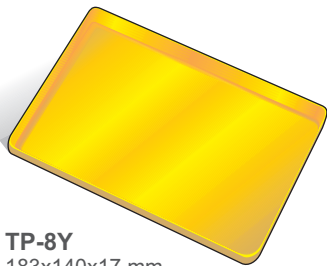

TP-8Y
183x140x17 mm
Unterteile allein
Only base
Vassoio solo
Bandeja suelta
Plateau seul

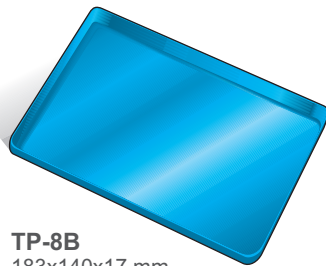

TP-8B
183x140x17 mm
Unterteile allein
Only base
Vassoio solo
Bandeja suelta
Plateau seul

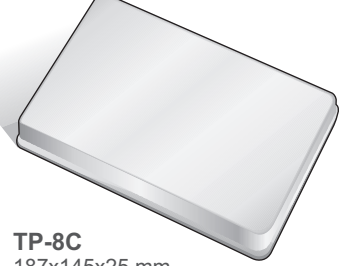

TP-8C
187x145x25 mm
Tray-Deckel, grau
Lid - Grey only
Coperchio - Solo argento
Tapa en color gris
Couvercle - seulement en gris



Dental Trays Container
Dental Trays Containers
Trays Contenitori per sterilizzare
Trays Contenedores para esterilizaciòn
Trays Containers pour stérilizer

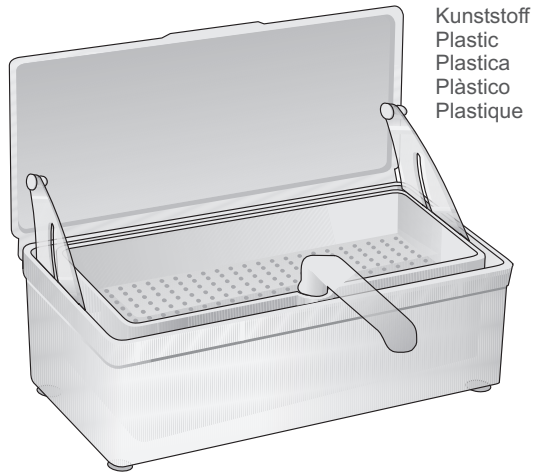

Kunststoff
Plastic
Plastica
Plástico
Plastique

BS-100
255 x 105 x 85 mm

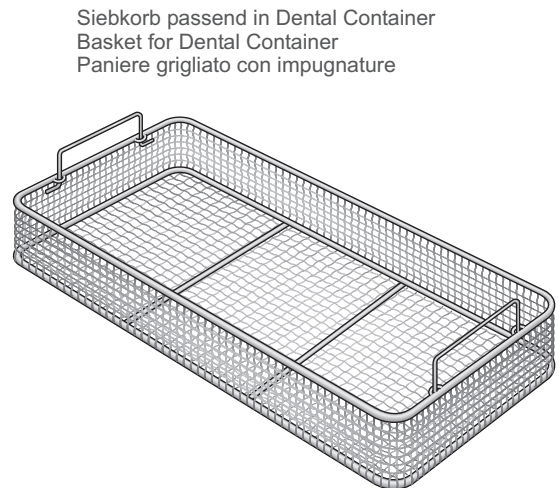

Siebkorb passend in Dental Container
Basket for Dental Container
Paniere grigliato con impugnature

CT-650
265 x 120 x 45 mm

Rostfrei - Stainless steel - Inox - Inoxidable - Inoxydable

Norm-tray complet mit tray-unterteile, deckel und instrumentenhalter für 23 instrumente
Instrument tray complete with base, lid and insert frame for 23 instruments
Portastrumenti completo di vassoio, coperchio e griglia per 23 strumenti
Bandeja completa de tapa y porta instrumentos para 23 instrumentos
Boite complete avec plateau et couvercle pour 23 instruments

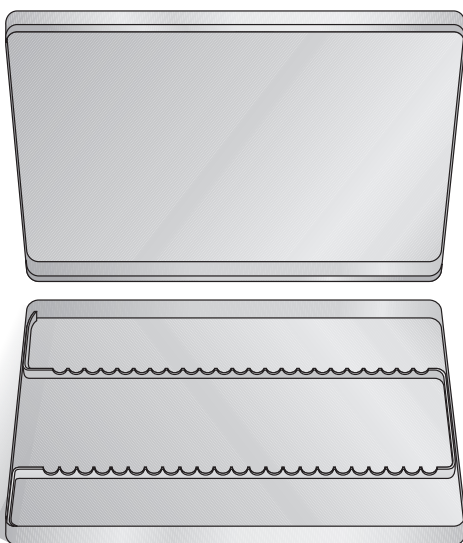

**TRAY INOX
T-I**
284 x 183 x 17 mm

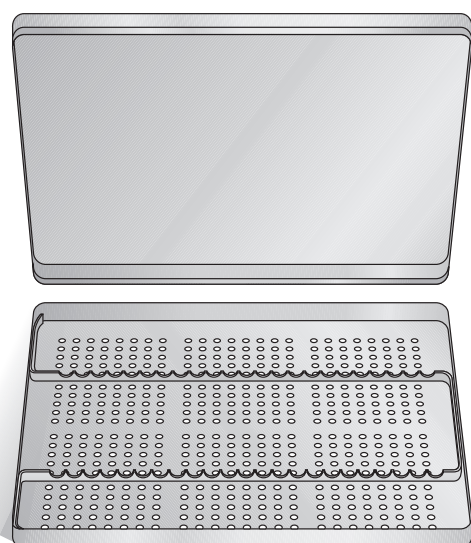

**TRAY INOX
T-IF**
284 x 183 x 17 mm



**RODHOIL
DB-OLR
50 cc**

Olio lubrificante per
strumenti chirurgici

RODHOIL

Schmiermittel mit hoher Dichte. Es sichert den perfekten Gebrauch und die Leichtgängigkeit aller chirurgischen Instrumente. Man gibt es auf die Verbindungen und Gelenke und in alle beweglichen Teile, die Reibungen unterworfen sind.

RODHOIL

Lubricant to high density. It assures the perfect utility and fluency of all the surgical instruments. For apply in to loosens, join and in all the parts in subject movement subject to attrition.

RODHOIL

Lubrificante ad alta densità. Assicura la perfetta funzionalità e scorrevolezza di tutti gli strumenti chirurgici. Da applicare negli snodi, giunture e in tutte le parti in movimento soggette ad attrito.



**CLEANLACT
DB-50M
500 cc**

**CLEANLACT
DB-1L
1000 cc**

Das wasserlösliche Schmiermittel verlängert die Lebensdauer von chirurgischen Instrumenten

Soluble lubricant extends useful life of surgical instruments

Lubrificante anticorrosivo e detergente per strumenti chirurgici

Lubrificante soluble en agua, so uso prolonga la duración de los instrumentos quirúrgicos

Lubrifiant soluble dans l'eau prolonge la vie des instruments chirurgicaux

CLEANLACT

Reinigungskonzentrat für chirurgische Instrumente. Es wirkt antibakteriell, nicht-ätzend und schmierig. Es garantiert die perfekte Erhaltung aller Instrumente aus Stahl, entfernt eventuelle Flecken, Ränder, und Bräunungen von Sterilisationen, Desinfektionen und Reinigungen mit hartem Wasser. Es sollte regelmäßig verwendet werden.

CLEANLACT

Product concentrated for surgical instruments. It explains an action anti-corrosive, antibacterium and lubricant. It guarantees the perfect maintenance of all the instruments in steel eliminating eventual stains and burnishes to sterilization, disinfection and to washings with hard waters. It used periodically.

CLEANLACT

Prodotto concentrato per strumenti chirurgici. Esplica un azione anticorrosiva batteriostatica e lubrificante. Garantisce il perfetto mantenimento di tutti gli strumenti in acciaio eliminando eventuali macchie, aloni e bruntiture dovute a sterilizzazioni, disinfezioni e a lavaggi con acque dure. Va usato periodicamente.

Schleifsteine
Sharpening stones
Pietre di Arkansas per affilatura strumenti
Materiales para afilar
Pierres d'affutage

Original Arkansas



DB-96
ARKANSAS n°8
100 x 50 x 13 mm

Teflon-Stäbchen
Teflon stick for tasting
Bastoncino di Teflon
per prova affilatura
Bastoncito de teflon
Petit bâton en teflon

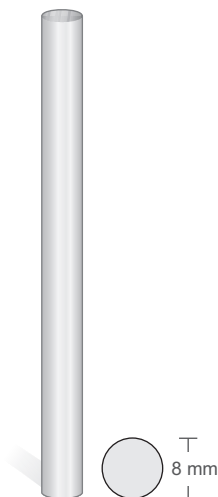

DB-15
100 mm

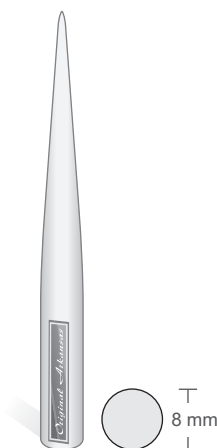

DB-299
ARKANSAS
conica n° 299
90 mm

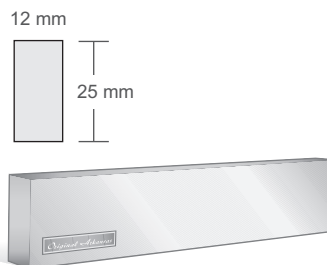

DB-4
ARKANSAS n°4
100 mm

Special Gummi für Metal
Special Rubber for Metal
Gomme speciali per metalli

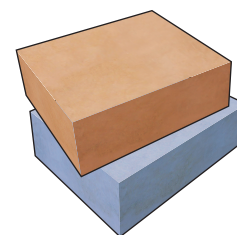

DB-07 50 x 40 x 20 mm Fein - Fine Grana Fine Finas - Fin	DB-08 50 x 40 x 20 mm Größ - Large Grana grossa Grande - Large
-----------------------------------------------------------------------------	-----------------------------------------------------------------------------------

Instrumente-Reinigungsbürste
Brush for instruments
Spazzolino per pulizia strumenti
Cepillo para instrumentos
Brosse pour instruments



SCHARPENIL
DB-OL
30 cc



DB-6A
ARKANSAS n°6A
100 mm

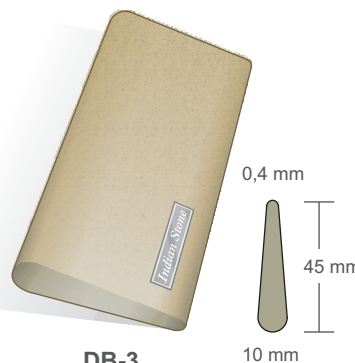

DB-3
INDIA n°6
100 mm

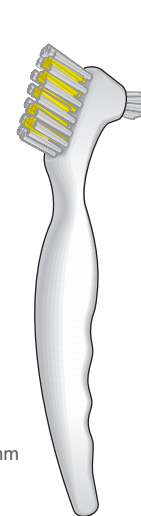

DB-11
155 mm



DB-12
175 mm



Vorbereitung - Nagel scheren
Preparation - Nail scissors
Preparazione - Forbici per unghie
Preparacion - Tijeras para uñas
Préparation - Ciseaux à ongles

Handwaschbürste
Nail brushes
Spazzola per unghie
Cepillos de uñas
Brosse à ongles

Sterilisier bar
Autoclavable
Autoclavabile
Esterilizabile
Stérilisable

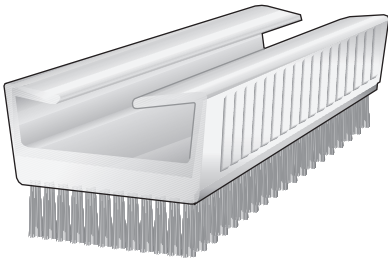

GF-200
4 x 11 cm

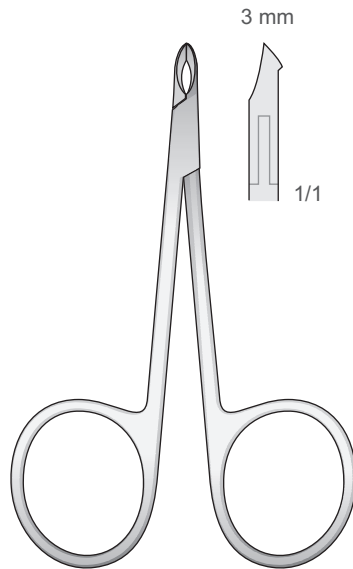

GS-40
85 mm

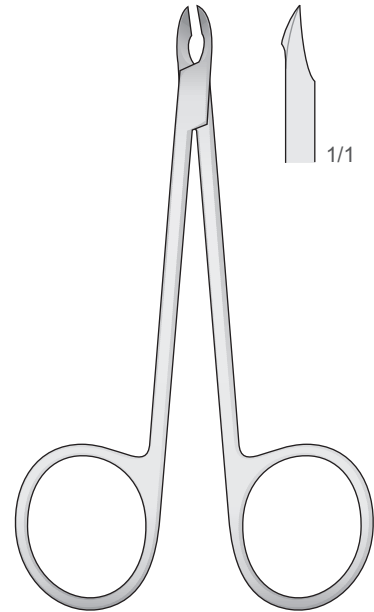

GS-52
100 mm

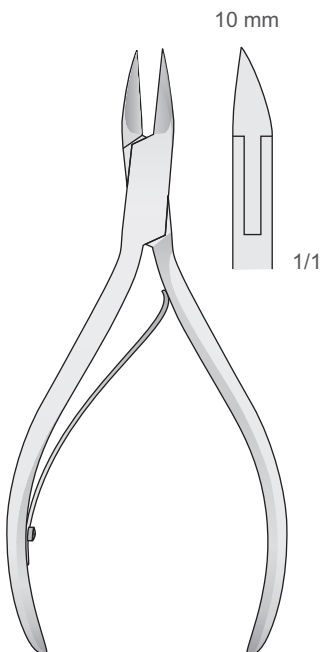

GS-42
100 mm

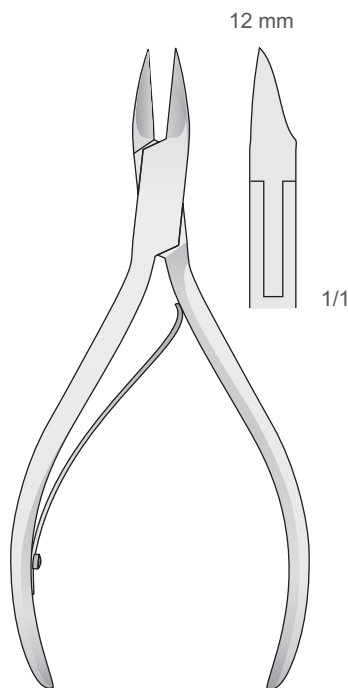

GS-44
110 mm

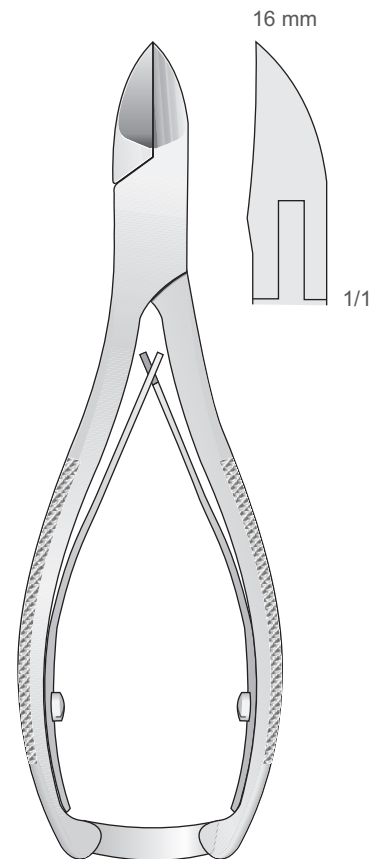

GS-48
140 mm



Sterilisierzangen zum Fassen und Halten Steriler Instrumente
Sterilizing forceps for picking up and holding of sterile instruments
Pinze per prelevare strumenti sterilizzati
Pinzas para esterilización
Pincas pour saisir les objets stérilisés



GS-02
145 mm

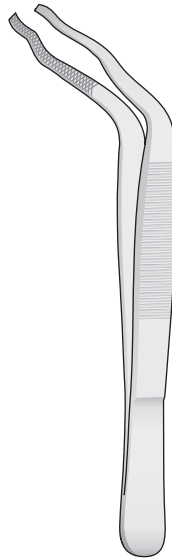

DAVIS
GS-03
160 mm



DAVIS
GS-04
200 mm

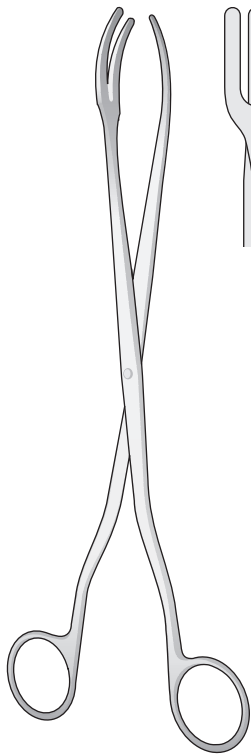

GS-10
200 mm

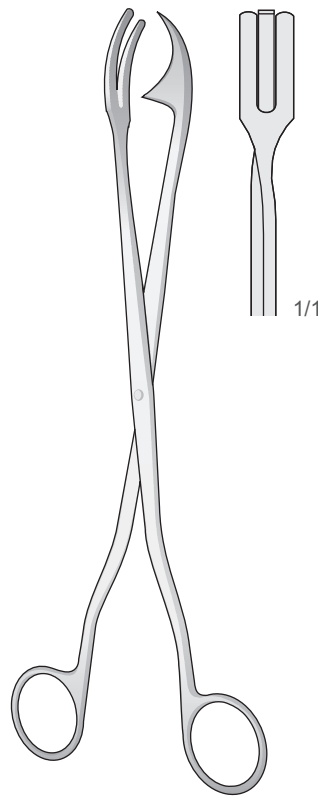

ROGGE
GS-06
230 mm

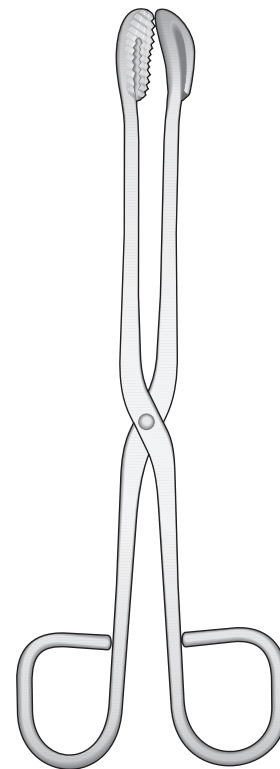

GS-13
200 mm

.16

Alfabetisches Inhaltsverzeichnis
Alphabetical Index
Indice alfabetico
Indice alfabetico
Index alphabetique

Zahnärztliche Chirurgie
Dental surgery
Chirurgia dentale
Cirugia dental
Chirurgie dentaire

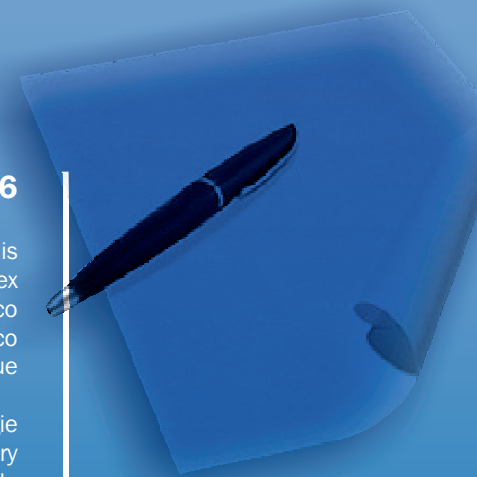



A

ADERER , Drahtbiegezange	324
ADSON , Absaugkanülen	319
- Mikro Pinzetten	114
- Chirurgischen Pinzetten	122, 131, 132, 133, 136
- Titan Pinzetten	118
ADSON-BROWN , Mikro Pinzetten	114
- Chirurgischen Pinzetten	131
AINSWORTH , Kofferdam Instrumente	308
ALLIS , Gewebefasszange	174
ANDREWS-PYNCHON , Absaugkanülen	315
APEXO , Wurzelheber	50
ARKANSAS , Schleifsteine	356
ARRUGA , Nadelhalter	158
AUSTIN , Wundhaken	184

B

BABY-ALLIS , Gewebefasszange	174
BABY-CRILE , Arterienklemmen	173
BABY-CRILEWOOD , Nadelhalter	156
BABY-METZENBAUM , Scheren	98
BABY-MIXTER , Arterienklemmen	171
BABY-YANKAUER , Absaugkanülen	315
BACKHAUS , Tuchklemmen	165
BALL , Füllungsinstrumente	292
BARRAQUER , Chirurgische Pinzetten	130
- Nadelhalter	142
BARRY , Wurzelheber	65
BARTH , Löffel	235
BEALE , Instrumente für Labor	345
BEASLEY-BABCOCK , Chirurgische Pinzetten	133
BEEBE , Scheren	326
- Drahtschneidezange	109
BEIN , Wurzelheber	43
BENNETT , Raspatorien	226
BERNARD , Wurzelheber	61
BEYER , Hohlmeißelzangen	244
BISHOP , Wangenhalter	191
BISHOP-HARMON , Mikro Pinzetten	114
BLACK , Schmelzinstrumente	283, 298
BLUMENTHAL , Hohlmeißelzangen	242
BÖHLER , Hohlmeißelzangen	245
BÖHM , Teleskopkronenzangen	335
BOLEY , Meßinstrumente	330
BOWLED-HENRY , Wundhaken	184
BOYNTON , Nadelhalter	158
BOYS-ALLIS , Gewebefasszange	174
BREWER , Klammerzange	309
BROWN , Mikro Pinzetten	114
- Chirurgische Pinzetten	131
BRUENINGS , Zungenspatel	195
BRUNS , Löffel	236
BUCHWALD , Zungenspatel	195
BUCK , Parodontalmesser	301
- Knochenfeilen	239

C

CARVER , Instrumente zum Modellieren von Füllungen	297
CASTROVIEJO , Mikro Pinzetten	114
- Nadelhalter	141, 143, 144, 145, 146
- Meßinstrumente	218
CAWOOD-MINNESOTA , Wangenhalter	191
CHADWICK , Scheren	97
CHOEN , Gewebezängchen	240
CHOMPRET , Syndesmotome	70
CITELLI , Hohlmeißelzangen	246
CLEVELAND , Hohlmeißelzangen	245
COHEN , Zahnzangen	31
COLLEGE , Titan Pinzetten	118
- Zahnpinzetten	120, 121
COLLIN , Zungenzangen	195
COLUMBIA , Küretten	262, 266
- Wundhaken	191
CONVERSE , Nadelhalter	153
CORN , Pinzetten	138
COTTLE , Scheren	86
- Chirurgische Hämmer	203
- Meißel	202

COTTLE-KNAPP , Scheren	86
COUPLAND , Absaugkanülen	317
- Wurzelheber	54
CRANE-CAPLAN , Küretten	306
- Chirurgische Pinzetten	123
CRANE-KAPLAN , Parodontalmesser	301
CRANEPICK , Wurzelheber	58
CRILE , Arterienklemmen	172
- Nadelhalter	159
CRILE-MURRAY , Nadelhalter	149
CRILE-WOOD , Nadelhalter	149, 155, 156
CRYER , Wurzelheber	53
- Zahnzangen	24, 28, 33, 34
CUSHING , Wundhaken	180

D

DANDY-MOSQUITO , Arterienklemmen	168
DAVIS , Sterilisierzangen zum Sterilen Instrumente	358
DE BAKEY , Chirurgische Pinzetten	122, 137
- Titan Pinzetten	118
- Nadelhalter	154
DE MARCO , Küretten	303
DEAN , Scheren	94
DERF , Nadelhalter	149, 153
DESMARRES , Wundhaken	179
- Chirurgische Pinzetten	130
DIETRICH , Nadelhalter	148
DINGMANN , Mundsperrler	193
- Knochenhaltezange	220
DOCKHORN , Wundhaken	180

E

ELLIS , Messer	79
EPKER , Osteotome	202

F

FAHNENSTOCK , Wachsmesser	339
FAHRENKRUG , Wurzelheber	59
FARABEUF , Wundhaken	190
FAURE , Tuchklemmen	165
FEDI , Meißel für Parodontologie	285
FELSCH , Zahnzange	16
FELT , Kompositinstrumente	271, 273
FOITZIK , Knochestopfer	216
FOSTER-GILLIES , Nadelhalter	157
FRAZIER , Absaugkanülen	318, 319
FREER , Osteotome	199
- Raspatorien	204
FREER-YASARGIL , Raspatorien	204
FRENZEL , Zungenspatel	195
FRIEDMANN , Hohlmeißelzange	242, 244
FURRER , Kupferingabnehmzange	335

G

GARDNER , Hohlmeißelzange	245
GERALD , Chirurgische Pinzetten	129, 136
- Titan Pinzetten	118
GERALD-BROWN , Chirurgische Pinzetten	129
GIESSEN , Raspatorien	204
GILLIES , Wundhaken	177
- Chirurgische Pinzetten	123
GOLDMAN-FOX , Parodontalmesser	301
- Küretten	304
- Elevatorien	229
- Scheren	91, 94, 105, 106
- Parodontometer	253
GOLDMAN-FOX-WILLIAMS , Parodontometer	289
GOLDSTEIN , Kompositinstrumente	271, 273
GRACEY , Küretten	261, 263, 264, 302, 303
GRAEFE , Messer	79
- Chirurgische Pinzetten	123, 133
GREENBERG-PAR , Scheren	101
GREENE , Wundhaken	194
GREGORY , Scheren	106
GRITMAN , Spatel	340
- Instrumente für Labor	345
GROSS , Kornzangen	167

H

HAJEK , Chirurgische Hämmer	203
HALSEY , Nadelhalter	149, 153
HALSTED , Arterienklemmen	170, 173
HALSTED-MOSQUITO , Arterienklemmen	170
- Ligature Instrumente	329
HARRIS , Zahnzange	27, 30
HARTMANN , Wundhaken	186
HARTMANN-BABY-MOSQUITO , Arterienklemmen	168
HEGAR , Nadelhalter	155, 159
HEIDBRINK , Wurzelheber	47
HEIDEMANN , Spatel	291
HEISTER , Mund sperrer	188
HEMINGWAY , Löffel	232, 233
HENAHAN , Raspatorien	225
HIRSCHFELD , Knochenfeilen	267
HOLLENBACK , Füllungsinstrumente	294, 297
HOPKINS , Raspatorien	228
HOWARD , Knochenfeilen	238
HULL , Zahnzange	28
HYLIN , Wurzelheber	56
- Instrumente für Labor	345, 346

I

ILIC , Gewebezängchen	240
INDIA , Schleifsteine	356
IRIS , Scheren	86, 88, 101, 103, 104
IVORY , Kofferdam Instrumente	308, 310, 311, 312
IWANSON , Meßinstrumente	330

J

JACOBSON , Löffel	235
- Nadelhalter	145
JACOBSON-MICRO , Arterienklemmen	168
JAMESON , Scheren	87
JAMESON-WERBER , Scheren	87
JANSEN , Löffel	235
JAQUETTE , Küretten	265, 305
JONES , Tuchklemmen	165
JOSEPH , Wundhaken	177
- Scheren	89, 106
JUDD-ALLIS , Tuchklemmen	174

K

KELLY , Scheren	92, 102, 103
- Arterienklemmen	172
KERLING , Kupferingabnehmzange	335
KERPEL , Löffel	234
KERRISON , Hohlmeißelzange	246
KEYES , Hautstanzen	213
KILIAN , Raspatorien	227
KILNER , Scheren	87, 91, 93, 101
KIRKLAND , Gewebezängchen	287, 301
KIRSCH , Wundhaken	182
KLEINER-KUTZ , Hohlmeißelzange	244
KOCHER , Wundhaken	179, 180
- Arterienklemmen	171, 172
KOCHER-LANGENBECK , Wundhaken	184
KÖNIG , Raspatorien	224
KOPP , Wurzelheber	57
KRALLENHEBER , Wurzelheber	53
KRAMER , Küretten	264
KRAMER-NEVINS , Küretten	264
- Meißel	200
KROENIG , Zungenspatel	195

L

LA FORCE , Messer	79
LA GRANGE , Scheren	94, 105
LADMORE , Füllungsinstrumente	295
LAHEY , Wundhaken	180
LANGÉ , Scaler	268
LANGENBECK , Wundhaken	184
LANGER , Küretten	266
LE CLUSE , Wurzelheber	65
LE CRON , Instrumente für Labor	345

LEMPERT , Hohlmeißelzange	243
LERICHE , Arterienklemmen	173
LESSMANN , Wachsmesser	339
LEXER , Scheren	95
LEXER-BABY (KNAPP) , Scheren	101
LICHTENBERG , Nadelhalter	158
LINDO-LEVIEN , Wurzelheber	57
LISTER , Sinus klemmen	167
LITTAUER , Scheren	108
LOCKING , Zahnpinzetten	121
LOCKLIN , Scheren	90, 92
LORNA , Tuchklemmen	166
LUCAE , Chirurgische Hämmer	203
LUCAS , Löffel	232
LUER , Hohlmeißelzange	243
LUKS , Nervinstrumente	254
LUNIATSCHEK , Watteträger	256
- Membranplatzierungsinstrumente	214

M

MARKLEY PLUGGERS , Füllungsinstrumente	294
MARTINI , Löffel	235
MATHIEU , Nadelhalter	158, 160, 161
MATY , Mundsperrer	189
MAYO , Scheren	96, 104
MAYO-HEGAR , Nadelhalter	154, 159
MAYO-LEXER , Scheren	95
MAYO-STILLE , Scheren	95
McCALL , Küretten	266, 305
McINDOE , Chirurgische Pinzetten	123
McKESSON , Absaugkanülen	316
MEAD , Chirurgische Hämmer	203
- Raspatorien	228
- Zahnzangen	35
- Hohlmeißelzange	242
MENEGHINI , Raspatorien	227
MERIAM , Zahnpinzetten	120, 121
MERRIT , Parodontometer	253
MERSHON , Bandandrücker	328
METZENBAUM , Scheren	89, 97, 98, 99, 103, 104
METZENBAUM-FINO , Scheren	98, 99, 100
MICRO-ADSON , Chirurgische Pinzetten	133
MICRO-HALSTED , Arterienklemmen	169
MICRO-RYDER , Nadelhalter	148
MICRO-VASCULAR , Nadelhalter	154
MIDDELDORPF , Wundhaken	182
MILLER , Knochenfeilen	238
- Pinzetten	138
- Ligature Instrumente	329
MILLER-APEXO , Wurzelheber	55
MILLER-COLBURN , Raspatorien	231
MINI-FRIEDMANN , Hohlmeißelzange	241, 242
MINI-GILLIES , Nadelhalter	150, 157
MINI-LAMBOTTE , Osteotome	199
MINI-LANGENBECK , Wundhaken	177
MINI-LEXER , Osteotome	202
MINI-OLSEN-HEGAR , Nadelhalter	150
MINNESOTA , Wundhaken	191
MISCH , Wundhaken	192
MITCHEL , Scaler	268
MOLT , Mundsperrer	188
- Löffel	237
- Raspatorien	225, 226, 229, 231
MOLT-DOYEN-COLLIN , Mundsperrer	188
MOLT-DOYEN-JANSEN , Mundsperrer	188

N

NABERS , Parodontometer	290
NEUMANN , Scheren	94
NEVIUS , Zahnzangen	25
NOYES , MiKro Scheren	83
NYSTRÖM , Kofferdam Instrumente	312

O

OBWEGESER , Wundhaken	183, 186, 187, 192
- Raspatorien	223
OBWEGESER-FREER , Raspatorien	204
OCHSENBEIN , Meißel für Parodontologie	285, 286



OLSEN-HEGAR, Nadelhalter 150, 157
ORBAN, Parodontalmesser 287, 301
ORINGER, Mundsperrer 189

P

P.K.THOMAS, Instrumente für Labor 341, 342, 343
PALMER, Klammerzange 309
PAQUETTE, Hautstanze 78
PARMLY, Zahnzangen 26
PARTSCH, Osteotome 201
- Meissel 201
PEAN, Arterienklemmen 171
PEAN-MURPHY, Kornzangen 167
- Ligature Instrumente 329
PECK-JOSEPH, Scheren 106
PEET, Wurzelkanalinstrumente 39
- Arterienklemmen 169
PELTON-CRANE, Absaugkanülen 318
PERRY, Chirurgische Pinzetten 124
PHYSICK, Zahnzange 31
POTT, Wurzelheber 60
POTTS-SMITH, Chirurgischen Pinzetten 135
PRICHARD, Periostotome 226

Q

QUINBY, Scheren 97

R

RAGNELL, Wundhaken 180
RAGNELL-DAVIS, Wundhaken 180
REYNOLDS, Scheren 93
ROACH, Instrumente für Labor 345
ROGER, Raspatorien 227
ROGGE, Sterilisierzangen zum Steriler Instrumente 358
ROSER-KÖNIG, Mundsperrer 188
ROSIN, Wurzelheber 48
ROUTURIER, Zahnzangen 11
ROUX, Wundhaken 190
ROUX-MAGNUS, Wundhaken 190
RULE, Küretten 307
RUSKIN, Hohlmeisselzange 244
RUSSIAN, Pinzetten 138
RYDER, Nadelhalter 151

S

SANDERS, Parodontalmesser 301
SAROT, Nadelhalter 155
SAUTTER, Raspatorien 204
SCHAEDEL, Tuchklemmen 165
SCHEDE, Löffel 236
SCHLUGER, Knochenfeilen 239
SEAN-MILLER, Wundhaken 179
SELDIN, Wurzelheber 58, 59
- Raspatorien 224
SEMKEN, Chirurgische Pinzetten 127, 137
SENN-GREEN, Wundhaken 180
SHURE, Separierzangen 327
SMAHA, Nadelhalter 161
SMITH, Scheren 107
- Drahtschneidezange 325
SPENCER, Scheren 108
STELLBRINK, Hohlmeisselzangen 241
STERNBERG, Wundhaken 191
STEVENS, Scheren 85, 93, 97
- Nadelhalter 148
STIEGLITZ, Zahnzangen 39
STILLE, Chirurgische Pinzetten 126
STITCH, Scheren 85
STOKE, Klammerzange 309
SUGARMAN, Knochenfeilen 239
SWEDISH, Nadelhalter 152

T

TAYLOR, Küretten 265, 306
TG CHISELS, Meissel für Parodontologie 286
TOBOLD, Wundhaken 186

TOFFLEMIRE, Kofferdam Instrumente 312
TOMES, Zahnzangen 28
TÖNNIS, Nadelhalter 159
TÖNNIS-ADSON, Scheren 98
TOWNER, Parodontalmesser 301
- Küretten 165
TOWNER-JAQUETTE, Küretten 307

U

UFFENORDE, Löffel 234
UNIVERSAL, Kronenabnehmer 338
- Watteträger 256
UNIVERSITY OF MICHIGAN, Parodontometer 253, 290

V

VEHE, Instrumente für Labor 345
VOLKMANN, Löffel 235, 236

W

WAHL, Knochenfeilen 239
WALTON, Scheren 85
WANGENSTEEN, Chirurgischen Pinzetten 136
WARD, Füllungsinstrumente 278
WARWICK-JAMES, Wurzelheber 48
WASSMUND, Wundhaken 194
WEBSTER, Nadelhalter 153
WEDELSTAEDT, Schmelzinstrumente 298
WEINGART, Drahtbiegezange 324
WEITLANER, Wundhaken 220
WERTHEIMER, Absaugkanülen 319
WESTCOTT, Mikro Scheren 83
- Füllungsinstrumente 280, 295
WHITE, Füllungsinstrumente 281
WHITEHEAD-JENNINGS, Mundsperrer 193
WIEDER, Wundhaken 186
WILAND, Instrumente zum Modellieren von Füllungen 297
WILLIAMS, Parodontometer 253
WILLIGER, Löffel 234, 235
- Raspatorien 223
WINTER, Wurzelheber 63, 64
WITZEL, Zahnzange 38
WOODSON, Füllungsinstrumente 295

Y

YANKAUER, Absaugkanülen 315
YOUNG, Zungenzangen 195
YOUNGER-GOOD, Küretten 306

Z

ZAHLE, Instrumente für Labor 346
ZAUFAL-JANSEN, Hohlmeisselzangen 244
ZIEGLER, Messer 79
ZIELINSKY, Meßinstrumente 330

Bontempi
Dental Catalogue



A

ADERER , Wire bending Pliers	324
ADSON , Suction tubes	319
- Delicate forceps	114
- Tissue forceps	122, 131, 132, 133, 136
- Titanium Tissue Forceps	118
ADSON-BROWN , Delicate forceps	114
- Tissue forceps	131
AINSWORTH , Rubber-Dam instrumente	308
ALLIS , Tissue Grasping forceps	174
ANDREWS-PYNCHON , Suction tubes	315
APEXO , Root elevators	50
ARKANSAS , Sharpening Stones	356
ARRUGA , Needle Holders	158
AUSTIN , Retractors	184

B

BABY-ALLIS , Tissue Grasping forceps	174
BABY-CRILE , Hemostatic Forceps	173
BABY-CRILEWOOD , Needle Holders	156
BABY-METZENBAUM , Scissors	98
BABY-MIXTER , Hemostatic Forceps	171
BABY-YANKAUER , Suction tubes	315
BACKHAUS , Towl Clamps	165
BALL , Filling Instruments	292
BARRAQUER , Tissue forceps	130
- Needle Holders	142
BARRY , Root elevators	65
BARTH , Curettes	235
BEALE , Instruments for laboratory	345
BEASLEY-BABCOCK , Tissue forceps	133
BEEBE , Scissors	326
- Wire and Plate cutting Scissors	109
BEIN , Root elevators	43
BENNETT , Raspatories	226
BERNARD , Root elevators	61
BEYER , Bone rongeurs	244
BISHOP , Cheek Retractor	191
BISHOP-HARMON , Delicate forceps	114
BLACK , Cavity preparation Instruments	283, 298
BLUMENTHAL , Bone rongeurs	242
BÖHLER , Bone rongeurs	245
BÖHM , Pliers for telescope crowns	335
BOLEY , Measuring Instruments	330
BOWLED-HENRY , Retractors	184
BOYNTON , Needle Holders	158
BOYS-ALLIS , Tissue Grasping Forceps	174
BREWER , Clamps forceps	309
BROWN , Delicate forceps	114
- Tissue forceps	131
BRUENINGS , Tongue depressors	195
BRUNS , Curettes	236
BUCHWALD , Tongue depressors	195
BUCK , Gingivectomy knives	301
- Bone files	239

C

CARVER , Amalgam carvers	297
CASTROVIEJO , Delicate forceps	114
- Needle Holders	141, 143, 144, 145, 146
- Measuring Instruments	218
CAWOOD-MINNESOTA , Cheek Retractors	191
CHADWICK , Scissors	97
CHOEN , Tissue Nippers	240
CHOMPRET , Syndesmotomes	70
CITELLI , Bone cutting forceps	246
CLEVELAND , Bone rongeurs	245
COHEN , Extracting forceps	31
COLLEGE , Titanium tissue forceps	118
- Cotton and Dressing pliers	120, 121
COLLIN , Tongue holding forceps	195
COLUMBIA , Curettes	262, 266
- Retractors	191
CONVERSE , Needle Holders	153
CORN , Forceps	138
COTTLE , Scissors	86
- Surgical Mallets	203
- Chisels	202

COTTLE-KNAPP , Scissors	86
COUPLAND , Suction tubes	317
- Root elevators	54
CRANE-CAPLAN , Curettes	306
- Tissue forceps	123
CRANE-KAPLAN , Gingivectomy knives	301
CRANEPICK , Root levators	58
CRILE , Hemostatic Forceps	172
- Needle Holders	159
CRILE-MURRAY , Needle Holders	149
CRILE-WOOD , Needle Holders	149, 155, 156
CRYER , Root levators	53
- Extracting Forceps	24, 28, 33, 34
CUSHING , Retractors	180

D

DANDY-MOSQUITO , Hemostatic forceps	168
DAVIS , Forceps for sterile instruments	358
DE BAKEY , Tissue forceps	122, 137
- Titanium Tissue forceps	118
- Needle holders	154
DE MARCO , Curettes	303
DEAN , Scissors	94
DERF , Needle Holders	149, 153
DESMARRES , Retractors	179
- Tissue Forceps	130
DIETRICH , Needle Holders	148
DINGMANN , Mouth gags	193
- Bone Holding Forceps	220
DOCKHORN , Retractors	180

E

ELLIS , Knives	79
EPKER , Osteotomes	202

F

FAHNENSTOCK , Wax knives	339
FAHRENKRUG , Root elevators	59
FARABEUF , Retractors	190
FAURE , Towel Clamps	165
FEDI , Periodontal chisels	285
FELSCH , Extracting forceps	16
FELT , Composite Instruments	271, 273
FOITZIK , Bone Syringes	216
FOSTER-GILLIES , Needle Holders	157
FRAZIER , Suction tubes	318, 319
FREER , Osteotomes	199
- Periosteals	204
FREER-YASARGIL , Periosteals	204
FRENZEL , Tongue depressors	195
FRIEDMANN , Bone rongeurs	242, 244
FURRER , Copper ring removing Pliers	335

G

GARDNER , Bone rongeurs	245
GERALD , Tissue forceps	129, 136
- Titanium Tissue Forceps	118
GERALD-BROWN , Tissue Forceps	129
GIESSEN , Periosteals	204
GILLIES , Retractors	177
- Tissue Forceps	123
GOLDMAN-FOX , Gingivectomy knives	301
- Curettes	304
- Elevators	229
- Scissors	91, 94, 105, 106
- Periodontal Probes	253
GOLDMAN-FOX-WILLIAMS , Periodontal Probes	289
GOLDSTEIN , Composite Instruments	271, 273
GRACEY , Curettes	261, 263, 264, 302, 303
GRAEFE , Knives	79
- Tissue Forceps	123, 133
GREENBERG-PAR , Scissors	101
GREENE , Retractors	194
GREGORY , Scissors	106
GRITMAN , Spatulas	340
- Instruments for Laboratory	345
GROSS , Dressing Forceps	167

H

HAJEK , Surgical Mallets	203
HALSEY , Needle Holders	149, 153
HALSTED , Hemostatic Forceps	170, 173
HALSTED-MOSQUITO , Hemostatic Forceps	170
- Ligating Instruments	329
HARRIS , Extracting Forceps	27, 30
HARTMANN , Retractors	186
HARTMANN-BABY-MOSQUITO , Hemostatic Forceps	168
HEGAR , Needle Holders	155, 159
HEIDBRINK , Root elevators	47
HEIDEMANN , Spatulas	291
HEISTER , Mouth Gags	188
HEMINGWAY , Curettes	232, 233
HENAHAN , Raspatories	225
HIRSCHFELD , Periodontal Files	267
HOLLENBACK , Filling Instruments	294, 297
HOPKINS , Raspatories	228
HOWARD , Bone Files	238
HULL , Extracting Forceps	28
HYLIN , Root elevators	56
- Instruments for laboratory	345, 346

I

ILIC , Tissue Nippers	240
INDIA , Sharpening Stones	356
IRIS , Scissors	86, 88, 101, 103, 104
IVORY , Rubber-Dam Instruments	308, 310, 311, 312
IWANSON , Measuring Instruments	330

J

JACOBSON , Curettes	235
- Needle Holders	145
JACOBSON-MICRO , Hemostatic Forceps	168
JAMESON , Scissors	87
JAMESON-WERBER , Scissors	87
JANSEN , Curettes	235
JAQUETTE , Curettes	265, 305
JONES , Towl Clamps	165
JOSEPH , Retractors	177
- Scissors	89, 106
JUDD-ALLIS , Tissue Grasping Forceps	174

K

KELLY , Scissors	92, 102, 103
- Hemostatic Forceps	172
KERLING , Copper ring removing Pliers	335
KERPEL , Curettes	234
KERRISON , Bone rongeurs	246
KEYES , Tissue Punches	213
KILIAN , Raspatories	227
KILNER , Scissors	87, 91, 93, 101
KIRKLAND , Gingivectomy knives	287, 301
KIRSCH , Retractors	182
KLEINER-KUTZ , Bone rongeurs	244
KOCHER , Retractors	179, 180
- Hemostatic Forceps	171, 172
KOCHER-LANGENBECK , Retractors	184
KÖNIG , Raspatories	224
KOPP , Root elevators	57
KRALLENHEBER , Root elevators	53
KRAMER , Curettes	264
KRAMER-NEVINS , Curettes	264
- Gouges	200
KROENIG , Tongue Holding Forceps	195

L

LA FORCE , Knives	79
LA GRANGE , Scissors	94, 105
LADMORE , Filling Instruments	295
LAHEY , Retractors	180
LANGE , Scalers	268
LANGENBECK , Retractors	184
LANGER , Curettes	266
LE CLUSE , Root elevators	65
LE CRON , Instruments for Laboratory	345

LEMPERT , Bone rongeurs	243
LERICHE , Hemostatic Forceps	173
LESSMANN , Wax knives	339
LEXER , Scissors	95
LEXER-BABY (KNAPP) , Scissors	101
LICHTENBERG , Needle Holders	158
LINDO-LEVIEN , Root elevators	57
LISTER , Sinus Forceps	167
LITTAUER , Scissors	108
LOCKING , Cotton and Dressind Pliers	121
LOCKLIN , Scissors	90, 92
LORNA , Towl Clamps	166
LUCAE , Surgical Mallets	203
LUCAS , Curettes	232
LUER , Bone rongeurs	243
LUKS , Endodontic Instruments	254
LUNIATSCHEK , Cotton Applicators	256
- Membrane Placement Instruments	214

M

MARKLEY PLUGGERS , Filling Instruments	294
MARTINI , Curettes	235
MATHIEU , Needle Holders	158, 160, 161
MATY , Mouth Gags	189
MAYO , Scissors	96, 104
MAYO-HEGAR , Needle Holders	154, 159
MAYO-LEXER , Scissors	95
MAYO-STILLE , Scissors	95
McCALL , Curettes	266, 305
McINDOE , Tissue Forceps	123
McKESSON , Suction Tubes	316
MEAD , Surgical Mallets	203
- Raspatories	228
- Extracting Forceps	35
- Bone rongeurs	242
MENEGHINI , Raspatories	227
MERIAM , Cotton and Dressing Pliers	120, 121
MERRIT , Periodontal Probes	253
MERSHON , Band Pusher	328
METZENBAUM , Scissors	89, 97, 98, 99, 103, 104
METZENBAUM-FINO , Scissors	98, 99, 100
MICRO-ADSON , Tissue Forceps	133
MICRO-HALSTED , Hemostatic Forceps	169
MICRO-RYDER , Needle Holders	148
MICRO-VASCULAR , Needle Holders	154
MIDDELDORPF , Retractors	182
MILLER , Bone Files	238
- Forceps	138
- Ligating Instruments	329
MILLER-APEXO , Root elevators	55
MILLER-COLBURN , Raspatories	231
MINI-FRIEDMANN , Bone rongeurs	241, 242
MINI-GILLIES , Needle Holders	150, 157
MINI-LAMBOTTE , Osteotomes	199
MINI-LANGENBECK , Retractors	177
MINI-LEXER , Osteotomes	202
MINI-OLSEN-HEGAR , Needle Holders	150
MINNESOTA , Retractors	191
MISCH , Retractors	192
MITCHEL , Scalers	268
MOLT , Mouth Gags	188
- Curettes	237
- Raspatories	225, 226, 229, 231
MOLT-DOYEN-COLLIN , Mouth Gags	188
MOLT-DOYEN-JANSEN , Mouth Gags	188

N

NABERS , Periodontal Probes	290
NEUMANN , Scissors	94
NEVIUS , Extracting Forceps	25
NOYES , Micro Scissors	83
NYSTRÖM , Matrix Retainers	312

O

OBWEGESER , Retractors	183, 186, 187, 192
- Raspatories	223
OBWEGESER-FREER , Periosteal	204
OCHSENBEIN , Periodontal Chisels	285, 286



OLSEN-HEGAR, Needle Holders 150, 157
ORBAN, Gingivectomy Knives 287, 301
ORINGER, Mouth Gags 189

P

P.K.THOMAS, Instruments for Laboratory 341, 342, 343
PALMER, Rubber Dam Clamp Forceps 309
PAQUETTE, Palatal Gingival razor blade 78
PARMLY, Extracting Forceps 26
PARTSCH, Osteotomes 201
- Chisel 201
PEAN, Hemostatic Forceps 171
PEAN-MURPHY, Dressing Forceps 167
- Ligating Instruments 329
PECK-JOSEPH, Scissors 106
PEET, Nerve Instruments 39
- Hemostatic Forceps 169
PELTON-CRANE, Suction Tubes 318
PERRY, Tissue Forceps 124
PHYSICK, Extracting Forceps 31
POTT, Root elevators 60
POTTS-SMITH, Tissue Forceps 135
PRICHARD, Raspatories 226

Q

QUINBY, Scissors 97

R

RAGNELL, Retractors 180
RAGNELL-DAVIS, Retractors 180
REYNOLDS, Scissors 93
ROACH, Instruments for Laboratory 345
ROGER, Raspatories 227
ROGGE, Forceps for sterile instruments 358
ROSER-KÖNIG, Mouth Gags 188
ROSIN, Root elevators 48
ROUTURIER, Extracting Forceps 11
ROUX, Retractors 190
ROUX-MAGNUS, Retractors 190
RULE, Curettes 307
RUSKIN, Bone rongeurs 244
RUSSIAN, Forceps 138
RYDER, Needle Holders 151

S

SANDERS, Gingivectomy Knives 301
SAROT, Needle Holders 155
SAUTTER, Periosteal 204
SCHAEDEL, Towl Clamps 165
SCHEDE, Curettes 236
SCHLUGER, Bone Files 239
SEAN-MILLER, Retractors 179
SELDIN, Root elevators 58, 59
- Raspatories 224
SEMKEN, Tissue Forceps 127, 137
SENN-GREEN, Retractors 180
SHURE, Separating Pliers 327
SMAHA, Needle Holders 161
SMITH, Scissors 107
- Wire cutting Pliers 325
SPENCER, Scissors 108
STELLBRINK, Bone rongeurs 241
STERNBERG, Retractors 191
STEVENS, Scissors 85, 93, 97
- Needle Holders 148
STIEGLITZ, Extracting Forceps 39
STILLE, Tissue Forceps 126
STITCH, Scissors 85
STOKE, Rubber Dam Clamp forceps 309
SUGARMAN, Bone Files 239
SWEDISH, Needle Holders 152

T

TAYLOR, Curettes 265, 306
TG CHISELS, Periodontal Chisels 286
TOBOLD, Retractors 186

TOFFLEMIRE, Matrix Retainers 312
TOMES, Extracting Forceps 28
TÖNNIS, Needle Holders 159
TÖNNIS-ADSON, Scissors 98
TOWNER, Gingivectomy Knives 301
- Curettes 165
TOWNER-JAQUETTE, Curettes 307

U

UFFENORDE, Curettes 234
UNIVERSAL, Crown Removers 338
- Cotton Applicators 256
UNIVERSITY OF MICHIGAN, Periodontal Probes 253, 290

V

VEHE, Instruments for Laboratory 345
VOLKMANN, Curettes 235, 236

W

WAHL, Bone Files 239
WALTON, Scissors 85
WANGENSTEEN, Tissue Forceps 136
WARD, Filling Instruments 278
WARWICK-JAMES, Root elevators 48
WASSMUND, Retractors 194
WEBSTER, Needle Holders 153
WEDELSTAEDT, Cavity preparation Instruments 298
WEINGART, Wire bending Pliers 324
WEITLANER, Retractors 220
WERTHEIMER, Suction Tubes 319
WESTCOTT, Micro Scissors 83
- Filling Instruments 280, 295
WHITE, Filling Instruments 281
WHITEHEAD-JENNINGS, Mouth Gags 193
WIEDER, Retractors 186
WILAND, Amalgam Carvers 297
WILLIAMS, Periodontal Probes 253
WILLIGER, Curettes 234, 235
- Raspatories 223
WINTER, Root elevators 63, 64
WITZEL, Extracting Forceps 38
WOODSON, Filling Instruments 295

Y

YANKAUER, Suction Tubes 315
YOUNG, Tongue Holding Forceps 195
YOUNGER-GOOD, Curettes 306

Z

ZAHLE, Instruments for Laboratory 346
ZAUFAL-JANSEN, Bone rongeurs 244
ZIEGLER, Knives 79
ZIELINSKY, Measuring Instruments 330



A

ADERER , Pinze per piegare fili	324
ADSON , Cannule per aspirazione	319
- Micro Pinzette	114
- Pinzette chirurgiche	122, 131, 132, 133, 136
- Pinzette in titanio	118
ADSON-BROWN , Micro Pinzette	114
- Pinzette chirurgiche	131
AINSWORTH , Strumenti per diga	308
ALLIS , Pinze per tessuti	174
ANDREWS-PYNCHON , Cannule per aspirazione	315
APEXO , Leve per radici	50
ARKANSAS , Pietre per affilatura strumenti	356
ARRUGA , Port'aghi	158
AUSTIN , Divaricatori	184

B

BABY-ALLIS , Pinze per tessuti	174
BABY-CRILE , Pinze emostatiche	173
BABY-CRILEWOOD , Port'aghi	156
BABY-METZENBAUM , Forbici	98
BABY-MIXTER , Pinze emostatiche	171
BABY-YANKAUER , Cannula per aspirazione	315
BACKHAUS , Fissateli	165
BALL , Otturatori	292
BARRAQUER , Pinzette chirurgiche	130
- Port'aghi	142
BARRY , Leve per radici	65
BARTH , Cucchiali	235
BEALE , Strumenti da laboratorio	345
BEASLEY-BABCOCK , Pinzette chirurgiche	133
BEEBE , Forbici	326
- Forbici per fili metallici	109
BEIN , Leve per radici	43
BENNETT , Periostotomi	226
BERNARD , Leve per radici	61
BEYER , Pinze ossivore	244
BISHOP , Divaricatori	191
BISHOP-HARMON , Micro Pinzette	114
BLACK , Strumenti da smalto	283, 298
BLUMENTHAL , Pinze ossivore	242
BÖHLER , Pinze ossivore	245
BÖHM , Pinze per corone telescopiche	335
BOLEY , Strumenti per misura	330
BOWLED-HENRY , Divaricatori	184
BOYNTON , Port'aghi	158
BOYS-ALLIS , Pinze per tessuti	174
BREWER , Pinze per ganci	309
BROWN , Micro Pinzette	114
- Pinzette chirurgiche	131
BRUENINGS , Abbassalingua	195
BRUNS , Cucchiali	236
BUCHWALD , Abbassalingua	195
BUCK , Bisturi per gengivectomia	301
- Lime per osso	239

C

CARVER , Strumenti per modellare e rifinire otturazioni	297
CASTROVIEJO , Micro Pinzette	114
- Port'aghi	141, 143, 144, 145, 146
- Strumenti per misura	218
CAWOOD-MINNESOTA , Divaricatori	191
CHADWICK , Forbici	97
CHOEN , Tronchesi per gengive e tessuti	240
CHOMPRET , Sindesmotomi	70
CITELLI , Pinze ossivore	246
CLEVELAND , Pinze ossivore	245
COHEN , Pinze da estrazione	31
COLLEGE , Pinzette in titanio	118
- Pinzette per medicazione	120, 121
COLLIN , Pinze tiralingua	195
COLUMBIA , Curette	262, 266
- Divaricatori	191
CONVERSE , Port'aghi	153
CORN , Pinzette	138
COTTLE , Forbici	86
- Martelli chirurgici	203
- Scalpelli	202

COTTLE-KNAPP , Forbici	86
COUPLAND , Cannule per aspirazione	317
- Leve per radici	54
CRANE-CAPLAN , Curette	306
- Pinzette chirurgiche	123
CRANE-KAPLAN , Bisturi per gengivectomia	301
CRANEPICK , Leve per radici	58
CRILE , Pinze emostatiche	172
- Port'aghi	159
CRILE-MURRAY , Port'aghi	149
CRILE-WOOD , Port'aghi	149, 155, 156
CRYER , Leve per radici	53
- Pinze da estrazione	24, 28, 33, 34
CUSHING , Divaricatori	180

D

DANDY-MOSQUITO , Pinze emostatiche	168
DAVIS , Pinze per prelevare strumenti sterilizzati	358
DE BAKEY , Pinzette chirurgiche	122, 137
- Pinzette in titanio	118
- Port'aghi	154
DE MARCO , Curette	303
DEAN , Forbici	94
DERF , Port'aghi	149, 153
DESMARRES , Divaricatori	179
- Pinzette chirurgiche	130
DIETRICH , Port'aghi	148
DINGMANN , Apribocca	193
- Pinza per fissare l'osso	220
DOCKHORN , Divaricatori	180

E

ELLIS , Coltelli	79
EPKER , Osteotomi	202

F

FAHNENSTOCK , Coltelli per cera	339
FAHRENKRUG , Leve per radici	59
FARABEUF , Divaricatori	190
FAURE , Fissateli	165
FEDI , Scalpelli per parodontologia	285
FELSCH , Pinze da estrazione	16
FELT , Strumenti per composito	271, 273
FOITZIK , Siringa per osso	216
FOSTER-GILLIES , Port'aghi	157
FRAZIER , Cannule per aspirazione	318, 319
FREER , Osteotomi	199
- Scollaperiostei	204
FREER-YASARGIL , Scollaperiostei	204
FRENZEL , Abbassalingua	195
FRIEDMANN , Pinze ossivore	242, 244
FURRER , Pinze per togliere anelli di rame	335

G

GARDNER , Pinze ossivore	245
GERALD , Pinzette chirurgiche	129, 136
- Pinzette in titanio	118
GERALD-BROWN , Pinzette chirurgiche	129
GIESSEN , Scollaperiostei	204
GILLIES , Divaricatori	177
- Pinzette chirurgiche	123
GOLDMAN-FOX , Bisturi per gengivectomia	301
- Curette	304
- Elevatori	229
- Forbici	91, 94, 105, 106
- Sonde parodontali	253
GOLDMAN-FOX-WILLIAMS , Sonde parodontali	289
GOLDSTEIN , Strumenti per composito	271, 273
GRACEY , Curette	261, 263, 264, 302, 303
GRAEFE , Coltelli	79
- Pinzette chirurgiche	123, 133
GREENBERG-PAR , Forbici	101
GREENE , Divaricatori	194
GREGORY , Forbici	106
GRITMAN , Spatole	340
- Strumenti da laboratorio	345
GROSS , Pinza porta tamponi	167

H

HAJEK , Martelli chirurgici	203
HALSEY , Port'aghi	149, 153
HALSTED , Pinze emostatiche	170, 173
HALSTED-MOSQUITO , Pinze emostatiche	170
- Strumenti per legature	329
HARRIS , Pinze da estrazione	27, 30
HARTMANN , Divaricatori	186
HARTMANN-BABY-MOSQUITO , Pinze emostatiche	168
HEGAR , Port'aghi	155, 159
HEIDBRINK , Leve per radici	47
HEIDEMANN , Spatole	291
HEISTER , Apribocca	188
HEMINGWAY , Cucchiali	232, 233
HENAHAN , Periostotomi	225
HIRSCHFELD , Lime parodontali	267
HOLLENBACK , Otturatori	294, 297
HOPKINS , Periostotomi	228
HOWARD , Lime per osso	238
HULL , Pinze da estrazione	28
HYLIN , Leve per radici	56
- Strumenti per laboratorio	345, 346

I

ILIC , Tronchesi per gengive e tessuti	240
INDIA , Pietre per affilatura strumenti	356
IRIS , Forbici	86, 88, 101, 103, 104
IVORY , Strumenti per diga	308, 310, 311, 312
IWANSON , Strumenti per misura	330

J

JACOBSON , Cucchiali	235
- Port'aghi	145
JACOBSON-MICRO , Pinze emostatiche	168
JAMESON , Forbici	87
JAMESON-WERBER , Forbici	87
JANSEN , Cucchiali	235
JAQUETTE , Curette	265, 305
JONES , Fissateli	165
JOSEPH , Divaricatori	177
- Forbici	89, 106
JUDD-ALLIS , Pinze per tessuti	174

K

KELLY , Forbici	92, 102, 103
- Pinze emostatiche	172
KERLING , Pinze per togliere anelli di rame	335
KERPEL , Cucchiali	234
KERRISON , Pinze ossivore	246
KEYES , Mucotomi punches	213
KILIAN , Periostotomi	227
KILNER , Forbici	87, 91, 93, 101
KIRKLAND , Bisturi per gengivectomia	287, 301
KIRSCH , Divaricatori	182
KLEINER-KUTZ , Pinze ossivore	244
KOCHER , Divaricatori	179, 180
- Pinze emostatiche	171, 172
KOCHER-LANGENBECK , Divaricatori	184
KÖNIG , Periostotomi	224
KOPP , Leve per radici	57
KRALLENHEBER , Leve per radici	53
KRAMER , Curette	264
KRAMER-NEVINS , Curette	264
- Scalpello	200
KROENIG , Abbassalingua	195

L

LA FORCE , Coltello	79
LA GRANGE , Forbici	94, 105
LADMORE , Otturatori	295
LAHEY , Divaricatori	180
LANGÉ , Ablatori tartaro	268
LANGENBECK , Divaricatori	184
LANGER , Curette	266
LE CLUSE , Leve per radici	65
LE CRON , Strumenti da laboratorio	345

LEMPERT , Pinze ossivore	243
LERICHE , Pinze emostatiche	173
LESSMANN , Coltelli per cera	339
LEXER , Forbici	95
LEXER-BABY (KNAPP) , Forbici	101
LICHTENBERG , Port'aghi	158
LINDO-LEVIEN , Leve per radici	57
LISTER , Pinze Sinus	167
LITTAUER , Forbici	108
LOCKING , Pinzette per medicazione	121
LOCKLIN , Forbici	90, 92
LORNA , Fissateli	166
LUCAE , Martelli chirurgici	203
LUCAS , Cucchiali	232
LUER , Pinze ossivore	243
LUKS , Strumenti per trattamenti canalari	254
LUNIATSCHEK , Portacotone	256
- Strumenti per posizionare membrana	214

M

MARKLEY PLUGGERS , Otturatori	294
MARTINI , Cucchiali	235
MATHIEU , Port'aghi	158, 160, 161
MATY , Apribocca	189
MAYO , Forbici	96, 104
MAYO-HEGAR , Port'aghi	154, 159
MAYO-LEXER , Forbici	95
MAYO-STILLE , Forbici	95
McCALL , Curette	266, 305
McINDOE , Pinzette chirurgiche	123
McKESSON , Cannule per aspirazione	316
MEAD , Martelli chirurgici	203
- Periostotomi	228
- Pinze da estrazione	35
- Pinze ossivore	242
MENEGHINI , Periostotomi	227
MERIAM , Pinzette per medicazione	120, 121
MERRIT , Sonde parodontali	253
MERSHON , Spingibande	328
METZENBAUM , Forbici	89, 97, 98, 99, 103, 104
METZENBAUM-FINO , Forbici	98, 99, 100
MICRO-ADSON , Pinzette chirurgiche	133
MICRO-HALSTED , Pinzette emostatiche	169
MICRO-RYDER , Port'aghi	148
MICRO-VASCULAR , Port'aghi	154
MIDDELDORPF , Divaricatori	182
MILLER , Lima per osso	238
- Pinzette	138
- Strumenti per legature	329
MILLER-APEXO , Leve per radici	55
MILLER-COLBURN , Periostotomi	231
MINI-FRIEDMANN , Pinze ossivore	241, 242
MINI-GILLIES , Port'aghi	150, 157
MINI-LAMBOTTE , Osteotomi	199
MINI-LANGENBECK , Divaricatori	177
MINI-LEXER , Osteotomi	202
MINI-OLSEN-HEGAR , Port'aghi	150
MINNESOTA , Divaricatori	191
MISCH , Divaricatori	192
MITCHEL , Ablatori di tartaro	268
MOLT , Apribocca	188
- Cucchiali	237
- Periostotomi	225, 226, 229, 231
MOLT-DOYEN-COLLIN , Apribocca	188
MOLT-DOYEN-JANSEN , Apribocca	188

N

NABERS , Sonde parodontali	290
NEUMANN , Forbici	94
NEVIUS , Pinze da estrazione	25
NOYES , Micro Forbici	83
NYSTRÖM , Porta matrici	312

O

OBWEGESER , Divaricatori	183, 186, 187, 192
- Periostotomi	223
OBWEGESER-FREER , Scollaperiostei	204
OCHSENBEIN , Scalpelli per parodontologia	285, 286



OLSEN-HEGAR, Port'aghi 150, 157
ORBAN, Bisturi per gengivectomia 287, 301
ORINGER, Apribocca 189

P

P.K.THOMAS, Strumenti per laboratorio 341, 342, 343
PALMER, Pinze per ganci 309
PAQUETTE, Mucotomo 78
PARMLY, Pinze da estrazione 26
PARTSCH, Osteotomi 201
- Scalpelli 201
PEAN, Pinze emostatiche 171
PEAN-MURPHY, Pinze porta tamponi 167
- Strumenti per legature 329
PECK-JOSEPH, Forbici 106
PEET, Strumenti per canali radicolari 39
- Pinze emostatiche 169
PELTON-CRANE, Cannule per aspirazione 318
PERRY, Pinzette chirurgiche 124
PHYSICK, Pinze da estrazione 31
POTT, Leve per radici 60
POTTS-SMITH, Pinzette chirurgiche 135
PRICHARD, Periostotomi 226

Q

QUINBY, Forbici 97

R

RAGNELL, Divaricatori 180
RAGNELL-DAVIS, Divaricatori 180
REYNOLDS, Forbici 93
ROACH, Strumenti per laboratorio 345
ROGER, Periostotomi 227
ROGGE, Pinze per prelevare strumenti sterilizzati 358
ROSER-KÖNIG, Apribocca 188
ROSIN, Leve per radici 48
ROUTURIER, Pinze da estrazione 11
ROUX, Divaricatori 190
ROUX-MAGNUS, Divaricatori 190
RULE, Curette 307
RUSKIN, Pinze ossivore 244
RUSSIAN, Pinzette 138
RYDER, Port'aghi 151

S

SANDERS, Bisturi per gengivectomia 301
SAROT, Port'aghi 155
SAUTTER, Scollaperiostei 204
SCHAEDEL, Fissateli 165
SCHEDE, Cucchiai 236
SCHLUGER, Lime per osso 239
SEAN-MILLER, Divaricatori 179
SELDIN, Leve per radici 58, 59
- Periostotomi 224
SEMKEN, Pinzette chirurgiche 127, 137
SENN-GREEN, Divaricatori 180
SHURE, Pinze tendielastici 327
SMAHA, Port'aghi 161
SMITH, Forbici 107
- Tronchesi per fili metallici 325
SPENCER, Forbici 108
STELLBRINK, Pinze ossivore 241
STERNBERG, Divaricatori 191
STEVENS, Forbici 85, 93, 97
- Port'aghi 148
STIEGLITZ, Pinze per estrazione 39
STILLE, Pinzette chirurgiche 126
STITCH, Forbici 85
STOKE, Pinze per ganci 309
SUGARMAN, Lime per osso 239
SWEDISH, Port'aghi 152

T

TAYLOR, Curette 265, 306
TG CHISELS, Scalpelli per parodontologia 286
TOBOLD, Divaricatori 186

TOFFLEMIRE, Porta matrice 312
TOMES, Pinze da estrazione 28
TÖNNIS, Port'aghi 159
TÖNNIS-ADSON, Forbici 98
TOWNER, Bisturi per gengivectomia 301
- Curette 165
TOWNER-JAQUETTE, Curette 307

U

UFFENORDE, Cucchiai 234
UNIVERSAL, Levacorone 338
- Portacotone 256
UNIVERSITY OF MICHIGAN, Sonde parodontali 253, 290

V

VEHE, Strumenti per laboratorio 345
VOLKMANN, Cucchiai 235, 236

W

WAHL, Lime per osso 239
WALTON, Forbici 85
WANGENSTEEN, Pinzette chirurgiche 136
WARD, Strumenti per otturazione 278
WARWICK-JAMES, Leve per radici 48
WASSMUND, Divaricatori 194
WEBSTER, Port'aghi 153
WEDELSTAEDT, Strumenti da smalto 298
WEINGART, Pinze per piegare fili 324
WEITLANER, Divaricatori 220
WERTHEIMER, Cannule per aspirazione 319
WESTCOTT, Micro Forbici 83
- Strumenti per otturazione 280, 295
WHITE, Strumenti per otturazione 281
WHITEHEAD-JENNINGS, Apribocca 193
WIEDER, Divaricatori 186
WILAND, Strumenti per modellare e rifinire otturazioni 297
WILLIAMS, Sonde parodontali 253
WILLIGER, Cucchiai 234, 235
- Periostotomi 223
WINTER, Leve per radici 63, 64
WITZEL, Pinze da estrazione 38
WOODSON, Strumenti per otturazione 295

Y

YANKAUER, Cannule per aspirazione 315
YOUNG, Pinza tiralingua 195
YOUNGER-GOOD, Curette 306

Z

ZAHLE, Strumenti da laboratorio 346
ZAUFAL-JANSEN, Pinze ossivore 244
ZIEGLER, Coltelli 79
ZIELINSKY, Strumenti per misura 330



A

ADERER , Alicates para doblar alambre	324
ADSON , Cánulas aspiradoras	319
- Pinzas finas	114
- Pinzas quirúrgicas	122, 131, 132, 133, 136
- Pinzas de titanio	118
ADSON-BROWN , Pinzas finas	114
- Pinzas quirúrgicas	131
AINSWORTH , Instrumentos para dique de goma	308
ALLIS , Pinzas para tejidos	174
ANDREWS-PYNCHON , Cánulas aspiradoras	315
APEXO , Elevadores para raíces	50
ARKANSAS , Materiales para afilar	356
ARRUGA , Portaagujas	158
AUSTIN , Separadores	184

B

BABY-ALLIS , Pinzas para tejidos	174
BABY-CRILE , Pinzas hemostáticas	173
BABY-CRILEWOOD , Portaagujas	156
BABY-METZENBAUM , Tijeras	98
BABY-MIXTER , Pinzas hemostáticas	171
BABY-YANKAUER , Cánulas aspiradoras	315
BACKHAUS , Pinzas de campo	165
BALL , Instrumentos para obturaciones	292
BARRAQUER , Pinzas quirúrgicas	130
- Portaagujas	142
BARRY , Elevadores para raíces	65
BARTH , Cucharillas	235
BEALE , Instrumentos para laboratorio	345
BEASLEY-BABCOCK , Pinzas quirúrgicas	133
BEEBE , Tijeras	326
- Tijeras para cortar alambre	109
BEIN , Elevadores para raíces	43
BENNETT , Rugines	226
BERNARD , Elevadores para raíces	61
BEYER , Pinzas para huesos	244
BISHOP , Separadores	191
BISHOP-HARMON , Pinzas finas	114
BLACK , Instrumentos para esmalte	283, 298
BLUMENTHAL , Pinzas para huesos	242
BÖHLER , Pinzas para huesos	245
BÖHM , Alicates para coronas telescópicas	335
BOLEY , Instrumentos para medir	330
BOWLED-HENRY , Separadores	184
BOYNTON , Portaagujas	158
BOYS-ALLIS , Pinzas para tejidos	174
BREWER , Pinzas para ganchos	309
BROWN , Pinzas finas	114
- Pinzas quirúrgicas	131
BRUENINGS , Abaja lenguas	195
BRUNS , Cucharillas	236
BUCHWALD , Abaja lenguas	195
BUCK , Bisturis para la gingivectomia	301
- Limas para huesos	239

C

CARVER , Instrumentos para modelar las obturaciones	297
CASTROVIEJO , Pinzas finas	114
- Portaagujas	141, 143, 144, 145, 146
- Instrumentos para medir	218
CAWOOD-MINNESOTA , Separadores	191
CHADWICK , Tijeras	97
CHOEN , Pinzas para cortar tejidos	240
CHOMPRET , Syndesmótomos	70
CITELLI , Pinzas para huesos	246
CLEVELAND , Pinzas para huesos	245
COHEN , Pinzas de extracción	31
COLLEGE , Pinzas de titanio	118
- Pinzas para vendajes	120, 121
COLLIN , Pinzas tira-lengua	195
COLUMBIA , Curetas	262, 266
- Separadores	191
CONVERSE , Portaagujas	153
CORN , Pinzas	138
COTTLE , Tijeras	86
- Martillos quirúrgicos	203
- Cinceles	202

COTTLE-KNAPP , Tijeras	86
COUPLAND , Cánulas aspiradoras	317
- Elevadores para raíces	54
CRANE-CAPLAN , Curetas	306
- Pinzas quirúrgicas	123
CRANE-KAPLAN , Bisturis para la gingivectomia	301
CRANEPICK , Elevadores para raíces	58
CRILE , Pinzas hemostáticas	172
- Portaagujas	159
CRILE-MURRAY , Portaagujas	149
CRILE-WOOD , Portaagujas	149, 155, 156
CRYER , Elevadores para raíces	53
- Pinzas de extracción	24, 28, 33, 34
CUSHING , Separadores	180

D

DANDY-MOSQUITO , Pinzas hemostáticas	168
DAVIS , Pinzas para esterilización	358
DE BAKEY , Pinzas quirúrgicas	122, 137
- Pinzas de titanio	118
- Portaagujas	154
DE MARCO , Curetas	303
DEAN , Tijeras	94
DERF , Portaagujas	149, 153
DESMARRES , Separadores	179
- Pinzas quirúrgicas	130
DIETRICH , Portaagujas	148
DINGMANN , Abrebocas	193
- Pinzas para coger huesos	220
DOCKHORN , Separadores	180

E

ELLIS , Bisturías	79
EPKER , Osteótomos	202

F

FAHNENSTOCK , Cuchillos para cera	339
FAHRENKRUG , Elevadores para raíces	59
FARABEUF , Separadores	190
FAURE , Pinzas de campo	165
FEDI , Cinceles para la cirugía periodontal	285
FELSCH , Pinzas de extracción	16
FELT , Instrumentos para composites	271, 273
FOITZIK , Instrumentos para huesos	216
FOSTER-GILLIES , Portaagujas	157
FRAZIER , Cánulas aspiradoras	318, 319
FREER , Osteótomos	199
- Periostótomos	204
FREER-YASARGIL , Periostótomos	204
FRENZEL , Abaja lenguas	195
FRIEDMANN , Pinzas para huesos	242, 244
FURRER , Pinzas para sacar anillos de cobre	335

G

GARDNER , Pinzas para huesos	245
GERALD , Pinzas quirúrgicas	129, 136
- Pinzas de titanio	118
GERALD-BROWN , Pinzas quirúrgicas	129
GIESSEN , Periostótomos	204
GILLIES , Separadores	177
- Pinzas quirúrgicas	123
GOLDMAN-FOX , Bisturis para la gingivectomia	301
- Curetas	304
- Elevadores	229
- Tijeras	91, 94, 105, 106
- Sondas parodontales	253
GOLDMAN-FOX-WILLIAMS , Sondas parodontales	289
GOLDSTEIN , Instrumentos para composites	271, 273
GRACEY , Curetas	261, 263, 264, 302, 303
GRAEFE , Bisturías	79
- Pinzas quirúrgicas	123, 133
GREENBERG-PAR , Tijeras	101
GREENE , Separadores	194
GREGORY , Tijeras	106
GRITMAN , Espátulas	340
- Instrumentos para laboratorio	345
GROSS , Pinzas porta tampones	167

H

HAJEK , Martillos quirurgicos	203
HALSEY , Portaagujas	149, 153
HALSTED , Pinzas hemostáticas	170, 173
HALSTED-MOSQUITO , Pinzas hemostáticas	170
- Instrumentos para ligaduras	329
HARRIS , Pinzas da extracciòn	27, 30
HARTMANN , Separadores	186
HARTMANN-BABY-MOSQUITO , Pinzas hemostáticas	168
HEGAR , Portaagujas	155, 159
HEIDBRINK , Elevadores para raices	47
HEIDEMANN , Espátulas	291
HEISTER , Abrebocas	188
HEMINGWAY , Cucharillas	232, 233
HENAHAN , Rugines	225
HIRSCHFELD , Limas parodontales	267
HOLLENBACK , Instrumentos para obturaciones	294, 297
HOPKINS , Rugines	228
HOWARD , Limas para huesos	238
HULL , Pinzas da extracciòn	28
HYLIN , Elevadores para raices	56
- Instrumentos para laboratorio	345, 346

I

ILIC , Pinzas para cortar tejidos	240
INDIA , Materiales para afilar	356
IRIS , Tijeras	86, 88, 101, 103, 104
IVORY , Instrumentos para dique	308, 310, 311, 312
IWANSON , Instrumentos para medir	330

J

JACOBSON , Cucharillas	235
- Portaagujas	145
JACOBSON-MICRO , Pinzas hemostáticas	168
JAMESON , Tijeras	87
JAMESON-WERBER , Tijeras	87
JANSEN , Cucharillas	235
JAQUETTE , Curetas	265, 305
JONES , Pinzas de campo	165
JOSEPH , Separadores	177
- Tijeras	89, 106
JUDD-ALLIS , Pinzas para tejidos	174

K

KELLY , Tijeras	92, 102, 103
- Pinzas hemostáticas	172
KERLING , Pinzas para sacar anillos de cobre	335
KERPEL , Cucharillas	234
KERRISON , Pinzas para huesos	246
KEYES , Punches para cortar tejidos	213
KILIAN , Rugines	227
KILNER , Tijeras	87, 91, 93, 101
KIRKLAND , Bisturis para la gingivectomia	287, 301
KIRSCH , Separadores	182
KLEINER-KUTZ , Pinzas para huesos	244
KOCHER , Separadores	179, 180
- Pinzas hemostáticas	171, 172
KOCHER-LANGENBECK , Separadores	184
KÖNIG , Rugines	224
KOPP , Elevadores para raices	57
KRALLENHEBER , Elevadores para raices	53
KRAMER , Curetas	264
KRAMER-NEVINS , Curetas	264
- Cinceles	200
KROENIG , Abaja lenguas	195

L

LA FORCE , Bisturios	79
LA GRANGE , Tijeras	94, 105
LADMORE , Instrumentos para obturacion	295
LAHEY , Separadores	180
LANGÉ , Limpiadores	268
LANGENBECK , Separadores	184
LANGER , Curetas	266
LE CLUSE , Elevadores para raices	65
LE CRON , Instrumentos para laboratorio	345

LEMPERT , Pinzas para huesos	243
LERICHE , Pinzas hemostáticas	173
LESSMANN , Cuchillos para cera	339
LEXER , Tijeras	95
LEXER-BABY (KNAPP) , Tijeras	101
LICHTENBERG , Portaagujas	158
LINDO-LEVIEN , Elevadores para raices	57
LISTER , Pinzas porta tampones	167
LITTAUER , Tijeras	108
LOCKING , Pinzas para vendajes	121
LOCKLIN , Tijeras	90, 92
LORNA , Pinzas de campo	166
LUCAE , Martillos quirurgicos	203
LUCAS , Cucharillas	232
LUER , Pinzas para huesos	243
LUKS , Instrumentos para nervios	254
LUNIATSCHEK , Porta algodones	256
- Instrumentos para colocar membranas	214

M

MARKLEY PLUGGERS , Instrumentos para obturacion	294
MARTINI , Cucharillas	235
MATHIEU , Portaagujas	158, 160, 161
MATY , Abrebocas	189
MAYO , Tijeras	96, 104
MAYO-HEGAR , Portaagujas	154, 159
MAYO-LEXER , Tijeras	95
MAYO-STILLE , Tijeras	95
McCALL , Curetas	266, 305
McINDOE , Pinzas quirùrgicas	123
McKESSON , Cànulas aspiradoras	316
MEAD , Martillos quirurgicos	203
- Rugines	228
- Pinzas da extracciòn	35
- Pinzas para huesos	242
MENEGHINI , Rugines	227
MERIAM , Pinzas para vendajes	120, 121
MERRIT , Sondas parodontales	253
MERSHON , Empujador de bandas	328
METZENBAUM , Tijeras	89, 97, 98, 99, 103, 104
METZENBAUM-FINO , Tijeras	98, 99, 100
MICRO-ADSON , Pinzas quirùrgicas	133
MICRO-HALSTED , Pinzas hemostáticas	169
MICRO-RYDER , Portaagujas	148
MICRO-VASCULAR , Portaagujas	154
MIDDELDORPF , Separadores	182
MILLER , Lima para huesos	238
- Pinzas	138
- Instrumentos para ligadura	329
MILLER-APEXO , Elevadores para raices	55
MILLER-COLBURN , Rugines	231
MINI-FRIEDMANN , Pinzas para huesos	241, 242
MINI-GILLIES , Portaagujas	150, 157
MINI-LAMBOTTE , Osteòtomos	199
MINI-LANGENBECK , Separadores	177
MINI-LEXER , Osteòtomos	202
MINI-OLSEN-HEGAR , Portaagujas	150
MINNESOTA , Separadores	191
MISCH , Separadores	192
MITCHEL , Limpiador	268
MOLT , Abrebocas	188
- Cucharillas	237
- Rugines	225, 226, 229, 231
MOLT-DOYEN-COLLIN , Abrebocas	188
MOLT-DOYEN-JANSEN , Abrebocas	188

N

NABERS , Sondas parodontales	290
NEUMANN , Tijeras	94
NEVIUS , Pinzas da extracciòn	25
NOYES , Micro Tijeras	83
NYSTRÖM , Instrumentos para dique	312

O

OBWEGESER , Separadores	183, 186, 187, 192
- Rugines	223
OBWEGESER-FREER , Periostòtomos	204
OCHSENBEIN , Cinceles para la cirugia periodontal	285, 286



OLSEN-HEGAR , Portaagujas	150, 157
ORBAN , Bisturis para la gingivectomia	287, 301
ORINGER , Abrebocas	189

P

P.K.THOMAS , Instrumentos para laboratorio	341, 342, 343
PALMER , Pinzas para ganchos	309
PAQUETTE , Punches para cortar tejidos	78
PARMLY , Pinzas da extracciòn	26
PARTSCH , Osteòtomos	201
- Cinceles	201
PEAN , Pinzas hemostàticas	171
PEAN-MURPHY , Pinzas para tampones	167
- Instrumentos para ligaduras	329
PECK-JOSEPH , Tijeras	106
PEET , Instrumentos de canal	39
- Pinzas hemostàticas	169
PELTON-CRANE , Cànulas aspiradoras	318
PERRY , Pinzas quirùrgicas	124
PHYSICK , Pinzas da extracciòn	31
POTT , Elevadore para raices	60
POTTS-SMITH , Pinzas quirùrgicas	135
PRICHARD , Rugines	226

Q

QUINBY , Tijeras	97
-------------------------	----

R

RAGNELL , Separadores	180
RAGNELL-DAVIS , Separadores	180
REYNOLDS , Tijeras	93
ROACH , Instrumentos para laboratorio	345
ROGER , Rugines	227
ROGGE , Pinzas para esterilizaciòn	358
ROSER-KÖNIG , Abrebocas	188
ROSIN , Elevadores para raices	48
ROUTURIER , Pinzas da extracciòn	11
ROUX , Separadores	190
ROUX-MAGNUS , Separadores	190
RULE , Curetas	307
RUSKIN , Pinzas para huesos	244
RUSSIAN , Pinzas	138
RYDER , Portaagujas	151

S

SANDERS , Bisturis para gingivectomia	301
SAROT , Portaagujas	155
SAUTTER , Rugines	204
SCHAEDEL , Pinzas de campo	165
SCHEDE , Cucharillas	236
SCHLUGER , Limas para huesos	239
SEAN-MILLER , Separadores	179
SELDIN , Elevadores para raices	58, 59
- Rugines	224
SEMKEN , Pinzas quirùrgicas	127, 137
SENN-GREEN , Separadores	180
SHURE , Pinza estira-elàsticos	327
SMAHA , Portaagujas	161
SMITH , Tijeras	107
- Alicates para cortar alambre	325
SPENCER , Tijeras	108
STELLBRINK , Pinzas para huesos	241
STERNBERG , Separadores	191
STEVENS , Tijeras	85, 93, 97
- Portaagujas	148
STIEGLITZ , Pinzas da extracciòn	39
STILLE , Pinzas quirùrgicas	126
STITCH , Tijeras	85
STOKE , Pinzas para ganchos	309
SUGARMAN , Lima para huesos	239
SWEDISH , Portaagujas	152

T

TAYLOR , Curetas	265, 306
TG CHISELS , Cinceles para cirugia periodontal	286
TOBOLD , Separadores	186

TOFFLEMIRE , Instrumentos para dique	312
TOMES , Pinzas da extracciòn	28
TÖNNIS , Portaagujas	159
TÖNNIS-ADSON , Tijeras	98
TOWNER , Bisturis para gingivectomia	301
- Curetas	165
TOWNER-JAQUETTE , Curetas	307

U

UFFENORDE , Cucharillas	234
UNIVERSAL , Instrumentos para quitar coronas	338
- Porta algodones	256
UNIVERSITY OF MICHIGAN , Sondas parodontales	253, 290

V

VEHE , Instrumentos para laboratorio	345
VOLKMANN , Cucharillas	235, 236

W

WAHL , Limas para huesos	239
WALTON , Tijeras	85
WANGENSTEEN , Pinzas quirùrgicas	136
WARD , Instrumentos para obturaciones	278
WARWICK-JAMES , Elevadores para raices	48
WASSMUND , Separadores	194
WEBSTER , Portaagujas	153
WEDELSTAEDT , Instrumentos para esmalte	298
WEINGART , Pinzas para doblar alambre	324
WEITLANER , Separadores	220
WERTHEIMER , Cànulas aspiradoras	319
WESTCOTT , Micro Tijeras	83
- Instrumentos para obturaciones	280, 295
WHITE , Instrumentos para obturaciones	281
WHITEHEAD-JENNINGS , Abrebocas	193
WIEDER , Separadores	186
WILAND , Instrumentos para modelar obturaciones	297
WILLIAMS , Sondas parodontales	253
WILLIGER , Cucharillas	234, 235
- Rugines	223
WINTER , Elevadores para raices	63, 64
WITZEL , Pinzas da extracciòn	38
WOODSON , Instrumentos para obturaciones	295

Y

YANKAUER , Cànulas aspiradoras	315
YOUNG , Pinzas tira-lengua	195
YOUNGER-GOOD , Curetas	306

Z

ZAHLE , Instrumentos para laboratorio	346
ZAUFAL-JANSEN , Pinzas para huesos	244
ZIEGLER , Bisturies	79
ZIELINSKY , Instrumentos para medir	330



A

ADERER , Pincés à pliers les fils	324
ADSON , Canules aspiratrices	319
- Micro Pincés	114
- Pincés chirurgicales	122, 131, 132, 133, 136
- Pincés en titane	118
ADSON-BROWN , Micro Pincés	114
- Pincés chirurgicales	131
AINSWORTH , Instruments pour digue	308
ALLIS , Pincés pour tissu	174
ANDREWS-PYNCHON , Canules aspiratrices	315
APEXO , Elevateurs à racines	50
ARKANSAS , Pierres d'affutage	356
ARRUGA , Porte aiguilles	158
AUSTIN , Ecarteurs	184

B

BABY-ALLIS , Pincés pour tissu	174
BABY-CRILE , Pincés hémostatiques	173
BABY-CRILEWOOD , Porte aiguilles	156
BABY-METZENBAUM , Ciseaux	98
BABY-MIXTER , Pincés hémostatiques	171
BABY-YANKAUER , Canules aspiratrices	315
BACKHAUS , Pincés à champs	165
BALL , Instruments pour obturations	292
BARRAQUER , Pincés chirurgicales	130
- Porte aiguilles	142
BARRY , Elevateurs à racines	65
BARTH , Curettes	235
BEALE , Instruments pour laboratoire	345
BEASLEY-BABCOCK , Pincés chirurgicales	133
BEEBE , Ciseaux	326
- Ciseaux coupe-fils métalliques	109
BEIN , Elevateurs à racines	43
BENNETT , Rugines	226
BERNARD , Elevateurs à racines	61
BEYER , Pincés gouges	244
BISHOP , Ecarteurs	191
BISHOP-HARMON , Micro Pincés	114
BLACK , Instruments à émail	283, 298
BLUMENTHAL , Pincés gouges	242
BÖHLER , Pincés gouges	245
BÖHM , Pincés pour couronnes télescopes	335
BOLEY , Instruments à mesurer	330
BOWLED-HENRY , Ecarteurs	184
BOYNTON , Porte aiguilles	158
BOYS-ALLIS , Pincés pour tissu	174
BREWER , Pincés à crampons	309
BROWN , Micro Pincés	114
- Pincés chirurgicales	131
BRUENINGS , Abaisse langues	195
BRUNS , Curettes	236
BUCHWALD , Abaisse langues	195
BUCK , Bistouris pour la gengivectomie	301
- Rapes à os	239

C

CARVER , Instruments à modeler les obturations	297
CASTROVIEJO , Micro Pincés	114
- Porte aiguilles	141, 143, 144, 145, 146
- Instruments à mesurer	218
CAWOOD-MINNESOTA , Ecarteurs	191
CHADWICK , Ciseaux	97
CHOEN , Pincés pour couper le tissu	240
CHOMPRET , Syndesmotomes	70
CITELLI , Pincés coupantes à os	246
CLEVELAND , Pincés gouges	245
COHEN , Daviers	31
COLLEGE , Pincés en titane	118
- Prélèvements pour coton	120, 121
COLLIN , Pincés tire-langue	195
COLUMBIA , Curettes	262, 266
- Ecarteurs	191
CONVERSE , Porte aiguilles	153
CORN , Pincés	138
COTTLE , Ciseaux	86
- Maillets chirurgicaux	203
- Scalpel	202

COTTLE-KNAPP , Ciseaux	86
COUPLAND , Canules aspiratrices	317
- Elevateurs à racines	54
CRANE-CAPLAN , Curettes	306
- Pincés chirurgicales	123
CRANE-KAPLAN , Bistouris pour la gengivectomie	301
CRANEPICK , Elevateurs à racines	58
CRILE , Pincés hémostatiques	172
- Porte aiguilles	159
CRILE-MURRAY , Porte aiguilles	149
CRILE-WOOD , Porte aiguilles	149, 155, 156
CRYER , Elevateurs à racines	53
- Daviers	24, 28, 33, 34
CUSHING , Ecarteurs	180

D

DANDY-MOSQUITO , Pincés hémostatiques	168
DAVIS , Pincés pour saisir les objets stérilisés	358
DE BAKEY , Pincés chirurgicales	122, 137
- Pincés en titane	118
- Porte aiguilles	154
DE MARCO , Curettes	303
DEAN , Ciseaux	94
DERF , Porte aiguilles	149, 153
DESMARRES , Ecarteurs	179
- Pincés chirurgicales	130
DIETRICH , Porte aiguilles	148
DINGMANN , Ecarteurs buccal	193
- Pincés pour tenir l'os	220
DOCKHORN , Ecarteurs	180

E

ELLIS , Couteau	79
EPKER , Ostéotomes	202

F

FAHNENSTOCK , Couteaux à cire	339
FAHRENKRUG , Elevateurs à racines	59
FARABEUF , Ecarteurs	190
FAURE , Pincés à champs	165
FEDI , Ciseaux de chirurgie	285
FELSCH , Daviers	16
FELT , Instruments pour composite	271, 273
FOITZIK , Compacteur à os pilons	216
FOSTER-GILLIES , Porte aiguilles	157
FRAZIER , Canules aspiratrices	318, 319
FREER , Ostéotomes	199
- Raspatoires	204
FREER-YASARGIL , Rugines	204
FRENZEL , Abaisse langues	195
FRIEDMANN , Pincés gouges	242, 244
FURRER , Pince à enlever les bagues en cuivre	335

G

GARDNER , Pincés gouges	245
GERALD , Pincés chirurgicales	129, 136
- Pincés en titane	118
GERALD-BROWN , Pincés chirurgicales	129
GIESSEN , Raspatoires	204
GILLIES , Ecarteurs	177
- Pincés chirurgicales	123
GOLDMAN-FOX , Bistouris pour la gengivectomie	301
- Curettes	304
- Elevateurs	229
- Ciseaux	91, 94, 105, 106
- Sondes parodontales	253
GOLDMAN-FOX-WILLIAMS , Sonde parodontales	289
GOLDSTEIN , Instruments pour composite	271, 273
GRACEY , Curettes	261, 263, 264, 302, 303
GRAEFE , Couteau	79
- Pincés chirurgicales	123, 133
GREENBERG-PAR , Ciseaux	101
GREENE , Ecarteurs	194
GREGORY , Ciseaux	106
GRITMAN , Spatules	340
- Instruments pour laboratoire	345
GROSS , Pincés porte-tampons	167

H

HAJEK , Maillets chirurgicaux	203
HALSEY , Porte aiguilles	149, 153
HALSTED , Pincés hémostatiques	170, 173
HALSTED-MOSQUITO , Pincés hémostatiques	170
- Instruments à ligature	329
HARRIS , Daviers	27, 30
HARTMANN , Ecarteurs	186
HARTMANN-BABY-MOSQUITO , Pincés hémostatiques	168
HEGAR , Porte aiguilles	155, 159
HEIDBRINK , Elevateurs à racines	47
HEIDEMANN , Spatules	291
HEISTER , Ecarteurs buccal	188
HEMINGWAY , Curettes	232, 233
HENAHAN , Rugines	225
HIRSCHFELD , Limes parodontales	267
HOLLENBACK , Instruments pour obturations	294, 297
HOPKINS , Rugines	228
HOWARD , Curettes	238
HULL , Daviers	28
HYLIN , Elevateurs à racines	56
- Instruments pour laboratoire	345, 346

I

ILIC , Pincés pour couper le tissu	240
INDIA , Pierres d'affutage	356
IRIS , Ciseaux	86, 88, 101, 103, 104
IVORY , Instruments pour digue	308, 310, 311, 312
IWANSON , Instruments à mesurer	330

J

JACOBSON , Curettes	235
- Porte aiguilles	145
JACOBSON-MICRO , Pincés hémostatiques	168
JAMESON , Ciseaux	87
JAMESON-WERBER , Ciseaux	87
JANSEN , Curettes	235
JAQUETTE , Curettes	265, 305
JONES , Pincés à champs	165
JOSEPH , Ecarteurs	177
- Ciseaux	89, 106
JUDD-ALLIS , Pincés pour tissus	174

K

KELLY , Ciseaux	92, 102, 103
- Pincés hémostatiques	172
KERLING , Pincés à enlever les bagues en cuivre	335
KERPEL , Curettes	234
KERRISON , Pincés coupantes à os	246
KEYES , Puncés à couper le tissu	213
KILIAN , Rugines	227
KILNER , Ciseaux	87, 91, 93, 101
KIRKLAND , Bistouris pour la gengivectomie	287, 301
KIRSCH , Ecarteurs	182
KLEINER-KUTZ , Pincés gouges	244
KOCHER , Ecarteurs	179, 180
- Pincés hémostatiques	171, 172
KOCHER-LANGENBECK , Ecarteurs	184
KÖNIG , Rugines	224
KOPP , Elevateurs à racines	57
KRALLENHEBER , Elevateurs à racines	53
KRAMER , Curettes	264
KRAMER-NEVINS , Curettes	264
- Scalpel	200
KROENIG , Abaisse langues	195

L

LA FORCE , Couteau	79
LA GRANGE , Ciseaux	94, 105
LADMORE , Instruments pour obturations	295
LAHEY , Ecarteurs	180
LANGÉ , Détartreurs	268
LANGENBECK , Ecarteurs	184
LANGER , Curettes	266
LE CLUSE , Elevateurs à racines	65
LE CRON , Instruments pour laboratoire	345

LEMPERT , Pincés gouges	243
LERICHE , Pincés hémostatiques	173
LESSMANN , Couteaux à cire	339
LEXER , Ciseaux	95
LEXER-BABY (KNAPP) , Ciseaux	101
LICHTENBERG , Porte aiguilles	158
LINDO-LEVIEN , Elevateurs à racines	57
LISTER , Pincés porte-tampons	167
LITTAUER , Ciseaux	108
LOCKING , Précelles pour coton	121
LOCKLIN , Ciseaux	90, 92
LORNA , Pincés à champs	166
LUCAE , Maillets chirurgicaux	203
LUCAS , Curettes	232
LUER , Pincés gouges	243
LUKS , Instruments à nerfs	254
LUNIATSCHEK , Porte cotons	256
- Instruments d'application de membrane	214

M

MARKLEY PLUGGERS , Instruments pour obturations	294
MARTINI , Curettes	235
MATHIEU , Porte aiguilles	158, 160, 161
MATY , Ecarteurs buccal	189
MAYO , Ciseaux	96, 104
MAYO-HEGAR , Porte aiguilles	154, 159
MAYO-LEXER , Ciseaux	95
MAYO-STILLE , Ciseaux	95
McCALL , Curettes	266, 305
McINDOE , Pincés chirurgicales	123
McKESSON , Canules aspiratrices	316
MEAD , Maillets chirurgicaux	203
- Rugines	228
- Daviers	35
- Pincés-gouges	242
MENEGHINI , Rugines	227
MERIAM , Précelles pour coton	120, 121
MERRIT , Sondes parodontales	253
MERSHON , Instruments pour poser les bagues	328
METZENBAUM , Ciseaux	89, 97, 98, 99, 103, 104
METZENBAUM-FINO , Ciseaux	98, 99, 100
MICRO-ADSON , Pincés chirurgicales	133
MICRO-HALSTED , Pincés hémostatiques	169
MICRO-RYDER , Porte aiguilles	148
MICRO-VASCULAR , Porte aiguilles	154
MIDDELDORPF , Ecarteurs	182
MILLER , Limes à os	238
- Pincés	138
- Instruments pour ligature	329
MILLER-APEXO , Elevateurs à racines	55
MILLER-COLBURN , Rugines	231
MINI-FRIEDMANN , Pincés-gouges	241, 242
MINI-GILLIES , Porte aiguilles	150, 157
MINI-LAMBOTTE , Ostéotomes	199
MINI-LANGENBECK , Ecarteurs	177
MINI-LEXER , Ostéotomes	202
MINI-OLSEN-HEGAR , Porte aiguilles	150
MINNESOTA , Ecarteurs	191
MISCH , Ecarteurs	192
MITCHEL , Détartreurs	268
MOLT , Ecarteur buccal	188
- Curettes	237
- Rugines	225, 226, 229, 231
MOLT-DOYEN-COLLIN , Ecarteur buccal	188
MOLT-DOYEN-JANSEN , Ecarteur buccal	188

N

NABERS , Sondes parodontales	290
NEUMANN , Ciseaux	94
NEVIUS , Daviers	25
NOYES , Micro Ciseaux	83
NYSTRÖM , Instruments pour digue	312

O

OBWEGESER , Ecarteurs	183, 186, 187, 192
- Rugines	223
OBWEGESER-FREER , Raspatoires	204
OCHSENBEIN , Ciseaux de chirurgie	285, 286



OLSEN-HEGAR, Porte aiguilles 150, 157
ORBAN, Bistouris pour la gengivectomie 287, 301
ORINGER, Ecarteur buccal 189

P

P.K.THOMAS, Instruments pour laboratoire 341, 342, 343
PALMER, Pincés à crampons 309
PAQUETTE, Punches 78
PARMLY, Daviers 26
PARTSCH, Ostéotomes 201
- Scalpel 201
PEAN, Pincés hémostatiques 171
PEAN-MURPHY, Pincés porte-tampons 167
- Instruments à ligature 329
PECK-JOSEPH, Ciseaux 106
PEET, Instruments pour canaux radiculaires 39
- Pincés hémostatiques 169
PELTON-CRANE, Canules aspiratrices 318
PERRY, Pincés chirurgicales 124
PHYSICK, Daviers 31
POTT, Elevateurs à racines 60
POTTS-SMITH, Pincés chirurgicales 135
PRICHARD, Rugines 226

Q

QUINBY, Ciseaux 97

R

RAGNELL, Ecarteurs 180
RAGNELL-DAVIS, Ecarteurs 180
REYNOLDS, Ciseaux 93
ROACH, Instruments pour laboratoire 345
ROGER, Rugines 227
ROGGE, Pincés pour saisir les objets stérilisés 358
ROSER-KÖNIG, Ecarteur buccal 188
ROSIN, Elevateurs à racines 48
ROUTURIER, Daviers 11
ROUX, Ecarteurs 190
ROUX-MAGNUS, Ecarteurs 190
RULE, Curettes 307
RUSKIN, Pincés-gouges 244
RUSSIAN, Pincés 138
RYDER, Porte aiguilles 151

S

SANDERS, Bistouris pour la gengivectomie 301
SAROT, Porte aiguilles 155
SAUTTER, Raspatoirs 204
SCHAEDEL, Pincés à tampons 165
SCHAEDEL, Curettes 236
SCHLUGER, Rapes à os 239
SEAN-MILLER, Ecarteurs 179
SELDIN, Elevateurs à racines 58, 59
- Rugines 224
SEMKEN, Pincés chirurgicales 127, 137
SENN-GREEN, Ecarteurs 180
SHURE, Pincés à separer 327
SMAHA, Porte aiguilles 161
SMITH, Ciseaux 107
- Pincés à couper les fils 325
SPENCER, Ciseaux 108
STELLBRINK, Pincés-gouges 241
STERNBERG, Ecarteurs 191
STEVENS, Ciseaux 85, 93, 97
- Porte aiguilles 148
STIEGLITZ, Daviers 39
STILLE, Pincés chirurgicales 126
STITCH, Ciseaux 85
STOKE, Pincés à crampons 309
SUGARMAN, Rapes à os 239
SWEDISH, Porte aiguilles 152

T

TAYLOR, Curettes 265, 306
TG CHISELS, Ciseaux de chirurgie 286
TOBOLD, Ecarteurs 186

TOFFLEMIRE, Porte matrices 312
TOMES, Daviers 28
TÖNNIS, Porte aiguilles 159
TÖNNIS-ADSON, Ciseaux 98
TOWNER, Bistouris pour la gengivectomie 301
- Curettes 165
TOWNER-JAQUETTE, Curettes 307

U

UFFENORDE, Curettes 234
UNIVERSAL, Instruments à détacher les couronnes 338
- Porte cotons 256
UNIVERSITY OF MICHIGAN, Sondes parodontales 253, 290

V

VEHE, Instruments pour laboratoire 345
VOLKMANN, Curettes 235, 236

W

WAHL, Rapes à os 239
WALTON, Ciseaux 85
WANGENSTEEN, Pincés chirurgicales 136
WARD, Instruments pour obturations 278
WARWICK-JAMES, Elevateurs à racines 48
WASSMUND, Ecarteurs 194
WEBSTER, Porte aiguilles 153
WEDELSTAEDT, Instruments à émail 298
WEINGART, Pincés à pliers les fils 324
WEITLANER, Ecarteurs 220
WERTHEIMER, Canules aspiratrices 319
WESTCOTT, Micro Ciseaux 83
- Instruments pour obturations 280, 295
WHITE, Instruments pour obturations 281
WHITEHEAD-JENNINGS, Ecarteur buccal 193
WIEDER, Ecarteurs 186
WILAND, Instruments à modeler les obturations 297
WILLIAMS, Sondes parodontales 253
WILLIGER, Curettes 234, 235
- Rugines 223
WINTER, Elevateurs à racines 63, 64
WITZEL, Daviers 38
WOODSON, Instruments pour obturations 295

Y

YANKAUER, Canules aspiratrices 315
YOUNG, Pincés tire-langue 195
YOUNGER-GOOD, Curettes 306

Z

ZAHLE, Instruments pour laboratoire 346
ZAUFAL-JANSEN, Pincés-gouges 244
ZIEGLER, Couteau 79
ZIELINSKY, Instruments à mesurer 330

.17

Nummernverzeichnis
Alphanumerical Index
Indice alfanumerico
Indice alfanumerico
Index alphanumerique

Zahnärztliche Chirurgie
Dental surgery
Chirurgia dentale
Cirugia dental
Chirurgie dentaire

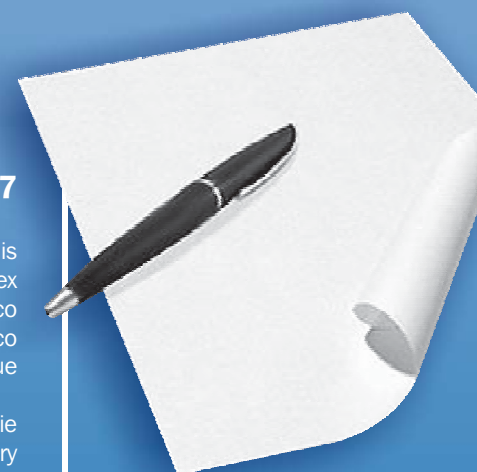



1	3	712-27S	292	716-204	298	718-271	304	AM-18L	27
2	3	712-29	292	716-211	298	718-272	304	AM-18R	27
4	8	712-101	292	716-212	298	718-273	304	AM-23	29
7	3	712-102	292	716-232	298	718-274	304	AM-24	27
8	8	712-103	292	716-234	298	718-275	304	AM-32	26
13	6	712-104	292	716-236	298	718-277	304	AM-32A	26
17	3	712-105	292			718-282	305	AM-53L	25
18	3	712-106	292	717-6	300	718-282A	305	AM-53R	25
21	8	712-111	293	717-14	300	718-284	305	AM-62	24
22 1/2L	11	712-111L	293	717-17	300	718-284S	305	AM-65	26
22 1/2R	11	712-112	293	717-17W	300	718-288S	305	AM-69	28
22	6	712-112L	293	717-18	300	718-332	305	AM-88L	25
29	4	712-113	293	717-18W	300	718-333	305	AM-88R	25
30	4	712-113L	293	717-19	300	718-335	305	AM-101	28
33	6	712-121	293	717-19W	300	718-CIO3	306	AM-103	30
33A	6	712-121L	293	717-31L	300	718-CK3	301	AM-150	24
46L	12	712-122	293	717-32L	300	718-CK6	306	AM-150A	24
48	12	712-122L	293	717-33L	300	718-EN1	229	AM-150AS	33
49	12	712-123	293	717-39	300	718-EN2	229	AM-150S	33
51	5	712-123L	293	717-64	300	718-EN3	229	AM-150X	32
51A	5	712-124	293	717-66	300	718-GF14	227	AM-151	28
51L	5	712-124L	293	717-100	300	718-M23	267	AM-151AS	33
55	10	712-131	295	717-101	300	718-M23A	267	AM-151S	33
56	10	712-132	295	717-102	300	718-M23B	267	AM-151X	32
67A	5	712-133	295	717-103	300	718-M8	227	AM-203	29
68	10	712-161H	294	717-104	300	718-M9	226	AM-210	27
68A	10	712-162H	294	717-111	300	718-PR3	226	AM-222	31
73	6	712-163H	294	717-112	300	718-RO-4	307	AM-250	31
74	7	712-164H	294			718-TO3	306		
74N	7	712-171	295	718-1/2	302	718-YGO8	306	AMG-150	34
75	7	712-172	295	718-2R	303			AMG-150S	34
79	8	712-182	295	718-3/4	302	719-111	307	AMG-151	34
79A	8	712-183	295	718-4R	303	719-125	307	AMG-151S	34
86A	7	712-191	296	718-5/6	302	719-126	307		
87	9	712-192	296	718-7/8	302			APICAL-1	52
89	9	712-201	296	718-9/10	302	720-85	232	APICAL-2	52
90	9	712-202	296	718-11MD	303	720-86	232	APICAL-3	52
400	38	712-221	296	718-11/12	302	720-87	232	APICAL-4	52
401	38	712-222	296	718-13MD	303	720-88	232		
		712-223	296	718-13/14	302	720-101	232	AT-1	268
707-1N	290	712-231	296	718-14	303	720-102	232	AT-2L	268
707-2N	290	712-232	296	718-24G	229	720-103	232	AT-2R	268
707-3GF	289	712-233	296	718-103	286	720-104	232	AT-6	268
707-3UM	290	712-241	229, 295	718-104	286	720-111	239	AT-12	268
707-3W	289	712-242	295	718-107	286	720-112	239		
707-6D1	288	712-243	295	718-113	286			B-3	281
707-6D2	288	712-251	296	718-123	301	725-1/2	47	B-4	281
707-6D3	288	712-256	296	718-133	301	725-3/4	47	B-28/29	281
707-16D1	288	712-259	296	718-147	301	725-3/4S	47	B-31/32	281
707-16D2	288	712-PFI	294	718-148	301	725-5/6	47	B-32	281
707-16GF	289			718-149	301			B-33	281
707-16UM	290	713-101	299	718-151	301	751-2/3	341	B-34	281
707-16W	289	713-102	299	718-154	301	751-121	341	B-35	281
707-17GF	289			718-156	301	751-122	341		
707-17UM	290	714-101	294	718-162	301	751-123	341	BB-46	75
707-17W	289	714-102	294	718-165	301	751-124	341	BB-48	75
707-23D1	288	714-CV11	299	718-170	301	751-125	341		
707-23D2	288			718-191	228			BD-01	121
707-23GF	289	715-101	297	718-192	228	A-1	275	BD-02	121
707-23UM	290	715-102	297	718-204	306			BD-03	121
707-23W	289	715-103	297	718-204S	306	AL-MA5	257	BD-04	124
707-202	288	715-103S	297	718-204SD	306	AL-PT1	343	BD-05	124
707-202A	288	715-311	291	718-210	239	AL-PT2	343	BD-06	124
707-203	288	715-312	291	718-212	239	AL-PT3	343	BD-07	124
707-2311	290	715-404	297	718-212S	239	AL-PT4	343	BD-08	345
707-2312	290	715-408	297	718-214S	239	AL-PT5	343	BD-09	134
707-GFW	289			718-215	204	AL-SETC/1	344	BD-09T	118
707-UT1	288	716-101	299	718-216	204	AL-SETC/2	344	BD-10	125
		716-102	299	718-223	228			BD-11	121
711-301	291	716-103	299	718-232	303	AM-1	24	BD-14	135
711-302	291	716-104	299	718-234	303	AM-5	31	BD-16	125
711-303	291	716-201	298	718-251	303	AM-15	30	BD-18	134
		716-202	298	718-252	303	AM-16	30	BD-19	128
712-18	292	716-203	298	718-268	307	AM-17	29	BD-20	134

BD-21	128	BD-159	138	BD-364	113	BT-06	225	BT-185	225
BD-23	134	BD-160	122	BD-365	113	BT-07	225	BT-186	177
BD-25	134	BD-160T	118	BD-366	113	BT-07M	225	BT-187	177
BD-26	134	BD-161	122	BD-367	113	BT-15	177	BT-188	177
BD-27	138	BD-165	122	BD-370	132	BT-16	177	BT-189	177
BD-30	132	BD-175	138	BD-371	132	BT-18	179	BT-210	177
BD-30T	118	BD-177	122	BD-372	133	BT-19	179	BT-211	177
BD-31	132	BD-178	122	BD-373	133	BT-20	190	BT-212	177
BD-31T	118	BD-194	124	BD-377	133	BT-25	190	BT-213	177
BD-32	124	BD-195	124	BD-378	133	BT-26	180	BT-214	177
BD-33	124	BD-196	124	BD-379	133	BT-27	180	BT-260	184
BD-35	124	BD-207	114	BD-380	131	BT-29	180	BT-264	181
BD-36	124	BD-208	114	BD-381	131	BT-33	184	BT-265	181
BD-38	128	BD-209	114	BD-382	131	BT-34	184	BT-283	190
BD-39	128	BD-210	137			BT-35	184	BT-284	190
BD-40	127	BD-211	137	BEIN-1T	51	BT-36	184	BT-285	190
BD-41	127	BD-212	137	BEIN-1Z	57	BT-38	178	BT-286	190
BD-42	127	BD-213	137	BEIN-2	51	BT-39	178	BT-287	190
BD-43	127	BD-216	137	BEIN-2Z	57	BT-40	178	BT-288	190
BD-44	127	BD-217	137	BEIN-3	51	BT-41	178	BT-289	190
BD-45	127	BD-221	137	BEIN-4	51	BT-42	178		
BD-46	127	BD-222	137	BEIN-4Z	57	BT-43	184	BV-23	220
BD-47	127	BD-223	137			BT-44	178		
BD-51	133	BD-224	137	BF-10	167	BT-45	178	C-1	233
BD-53	135	BD-230	136	BF-12	167	BT-46	178	C-2	233
BD-56	130	BD-231	136	BF-20	167	BT-48	180	C-3	233
BD-57	130	BD-232	136	BF-22	167, 329	BT-49	180	C-4	233
BD-58	130	BD-240	126	BF-23	167	BT-50	178	C-11	337
BD-59	130	BD-241	126	BF-24	167	BT-51	178	C-12	337
BD-60	126	BD-242	126	BF-25	167	BT-52	178	C-13	337
BD-61	126	BD-243	126	BF-38	165	BT-54	178	C-30	337
BD-62	126	BD-244	126	BF-40	165	BT-55	178	C-34	337
BD-63	126	BD-245	126	BF-41	165	BT-56	178	C-35	337
BD-65	126	BD-246	126	BF-42	165	BT-60	184	C-36	337
BD-67	126	BD-247	126	BF-43	165	BT-62	184	C-41	337
BD-70	132	BD-248	126	BF-44	165	BT-64	184	C-42	337
BD-71	122, 132	BD-249	126	BF-45	165	BT-66	184	C-43	337
BD-72	132	BD-250	136	BF-46	165	BT-67	187	C-71	336
BD-73	122, 132	BD-251	136	BF-48	165	BT-68	187	C-72	336
BD-75	125	BD-253	114	BF-50	166	BT-69	194	C-73	336
BD-75T	118	BD-267	137	BF-52	166	BT-70	179	C-74	336
BD-76	125	BD-270	125	BF-75	166	BT-72	179		
BD-80	122	BD-270T	118	BF-94	167	BT-74	179	CD-1	276
BD-80T	118	BD-271	134	BF-95	167	BT-77	179	CD-2	276
BD-81	122	BD-272	134			BT-80	182	CD-3	276
BD-82	122	BD-273	134	BK-30	346	BT-81	182	CD-4	276
BD-83	122	BD-274	134			BT-82	182		
BD-90	131	BD-275	134	BM-01	157	BT-90	182	CG	339
BD-91	127	BD-276	134	BM-02	157	BT-91	182	CGL	339
BD-92	131	BD-279	123	BM-03	157	BT-92	183	CGS	339
BD-93	131	BD-280	123	BM-04	157	BT-93	183		
BD-94	131	BD-281	128	BM-61	150	BT-94	183	CH-1	70
BD-95	127	BD-282	128	BM-62	150	BT-95	183	CH-2	70
BD-96	124	BD-283	123	BM-63	150	BT-96	183	CH-3	70
BD-97	125	BD-284	123			BT-100	183	CH-4	70
BD-98	125	BD-285T	118	BR-20	349	BT-109	180	CH-11	70
BD-99	125	BD-287	135	BR-25	349	BT-117	179	CH-12	70
BD-104	128	BD-288	135	BR-28	349	BT-118	179	CH-13	70
BD-109	128	BD-289	135			BT-131	194	CH-14	70
BD-110	128	BD-290	135	BS-1	349	BT-132	194		
BD-111	128	BD-291	135	BS-27	349	BT-134	181	CL-1B	344
BD-130	130	BD-292	135	BS-32	349	BT-135	181	CL-1R	344
BD-131	130	BD-348	114	BS-40	350	BT-139	180	CL-2B	344
BD-133	128	BD-349	114	BS-41	350	BT-140	180	CL-2R	344
BD-134	128	BD-351	135	BS-42	350	BT-152	183	CL-3B	344
BD-135	133	BD-352	135	BS-43	350	BT-153	183	CL-3R	344
BD-137	128	BD-353	135	BS-59	351	BT-154	183		
BD-141	131	BD-354	135	BS-60	206, 207, 351	BT-155	183	CM	340
BD-142	126	BD-355	135	BS-61	351	BT-156	183		
BD-143	126	BD-356	135	BS-100	354	BT-157	183	CO-1	54
BD-144	128	BD-360	113			BT-158	192	CO-2	54
BD-145	125	BD-361	113	BT-1	179	BT-159	192	CO-3	54
BD-148	125	BD-362	113	BT-2	179	BT-183	225	CO-11	54
BD-158	138	BD-363	113	BT-05	225	BT-184	225	CO-12	54



CO-13	54	DB-183	246	DL-2	53	DL-99	60	DP-104	109
COL-1/2	261	DB-299	356	DL-05	59	DL-100	63	DP-105	109
COL-2RL	261	DB-300	219	DL-06	59	DL-101	63	DP-114	324
COL-3/4	261	DB-OL	356	DL-11	56	DL-102	46	DP-116	324
COL-4RL	261	DB-OLR	355	DL-13	56	DL-103	46	DP-118	323
COL-13/14	261			DL-14	56	DL-104	46	DP-119	323
		DEAN	94	DL-17	56	DL-105	46	DP-120	107, 326
COLLEGE	120, 329	DEAN-TC	102	DL-18	56	DL-106	43	DP-121	323
COLLEGE-S	120	DF-00	308	DL-19	56	DL-107	43	DP-124	327
		DF-00L	308	DL-20	48	DL-108	65	DP-125	328
CP	339	DF-00M	308	DL-21	48	DL-109	65	DP-126	329
CPL	339	DF-00N	308	DL-22	48	DL-110	65	DP-127	329
CPS	339	DF-00P	308	DL-24	60	DL-111	65	DP-128	329
		DF-00R	308	DL-25	60	DL-112	46	DP-129	329
CS-01	349	DF-00V	308	DL-27	53	DL-113	46	DP-132	329
CS-02	349	DF-01/5	312	DL-28	53	DL-114	46	DP-133	329
CS-03	349	DF-01/6	312	DL-30	57	DL-115	46	DP-134	324
CS-04	349	DF-01/7	312	DL-31	57	DL-116	43	DP-135	324
CS-05	349	DF-02	308	DL-32	53	DL-117	43	DP-136	338
CS-12	349	DF-02M	308	DL-33	53	DL-118	43	DP-137	338
CS-15	349	DF-02P	308	DL-34	50	DL-123	61	DP-140	331
CS-19	349	DF-02R	308	DL-35	50	DL-124	61	DP-720	330
		DF-03/1	312	DL-36	50	DL-C	338	DP-721	330
CT-555	351	DF-03/2	312	DL-37	50	DL-V	338	DP-723	330
CT-560	351	DF-03/3	312	DL-38	50			DP-724	330
CT-565	351	DF-03/7	312	DL-42	43	DO-1	238	DP-725	330
CT-650	354	DF-03/8	312	DL-43	43	DO-2	238	DP-730	330
CT-651	351	DF-03/9	312	DL-44	43	DO-3	238		
CT-652	351	DF-03/10	312	DL-45	43	DO-4	238	DR-40	39, 169
CT-653	351	DF-03/11	312	DL-46	43	DO-4C	238	DR-50	39
		DF-03/12	312	DL-47	43	DO-5	238	DR-60	39
CU-1/2	261	DF-03/13	312	DL-48	59	DO-08	186	DR-70	39
CU-3/4	261	DF-04	312	DL-49	59	DO-09	186	DR-78	138, 329
CU-5/6	261	DF-05/5	312	DL-50	234	DO-40	186	DR-80	138
CU-7/8	261	DF-05/6	312	DL-51	234	DO-41	192		
CU-9/10	261	DF-05/7	312	DL-52	234	DO-59	223	E-0	284
CU-11/12	261	DF-06	312	DL-54	59	DO-63	223	E-1	284
CU-13/14	261	DF-07	312	DL-58	48	DO-65	223	E-2	284
CU-MC1	231	DF-08	312	DL-59	62	DO-67	223	E-3	284
		DF-09	312	DL-60	338	DO-140	202	E-4	284
CV-11	276	DF-10	309	DL-61	62	DO-141	202		
		DF-12	310	DL-62	62	DO-142	192	EC-1	284
DA-01	40	DF-15	309	DL-63	62	DO-143	202	EC-2	284
DA-01M	40	DF-16	309	DL-64	64	DO-175	184		
DA-02	40	DF-18	309	DL-65	64	DO-180	202	EN-M1	230
DA-03	40	DF-20	327	DL-66	64	DO-181	202	EN-M2	230
DA-04	120	DF-21	327	DL-67	64	DO-182	202	EN-M3	230
DA-05	120	DF-30	311	DL-68	62	DO-183	202	EN-M4	230
DA-06	138	DF-32	311	DL-69	62	DO-184	202	EN-M5	230
DA-07	138	DF-40	310	DL-73	61	DO-185	202	EN-M6	230
DA-08	138	DF-40/1	310	DL-74	61	DO-186	202	EN-M7	230
DA-09	121	DF-40/2	310	DL-75	61	DO-196	200		
DA-10	40	DF-40/3	310	DL-76	49	DO-204	184	ES-13	204
		DF-41	310	DL-77	49	DO-204L	184	ES-27	228
DB-01	123	DF-41/4	310	DL-78	49	DO-212	184	ES-44	130
DB-1L	355	DF-41/5	310	DL-79	49			ES-65	130
DB-02	123	DF-41/6	310	DL-81	44	DP-24	335		
DB-3	356	DF-43	310	DL-82	44	DP-24C	335	EX-11	252
DB-4	356	DF-50	327	DL-83	44	DP-24R	335	EX-12	252
DB-6A	356	DF-126	311	DL-84	44	DP-28	335		
DB-07	356	DF-127	311	DL-85	44	DP-29	335	F-2/3	276
DB-08	356	DF-128	311	DL-86	44	DP-38	335		
DB-11	356	DF-129	311	DL-87	44	DP-38A	335	FD-06	84
DB-12	356	DF-130	311	DL-88	62	DP-38R	335	FD-08	84
DB-15	356	DF-131	311	DL-89	62	DP-50	328	FD-10	83
DB-50M	355	DF-151	311	DL-90	65	DP-52	329	FD-12	83
DB-96	356	DF-160	311	DL-91	45	DP-54	327	FD-13	83
DB-177	246			DL-92	45	DP-90	109, 326	FD-14	141
DB-178	246	DK-26	38	DL-93	45	DP-91	109, 326	FD-15	83
DB-179	246	DK-27	38	DL-94	45	DP-92	109, 326	FD-16	141
DB-180	246			DL-95	45	DP-100	328	FD-17	141
DB-181	246	DL-0	338	DL-96	45	DP-101	109, 326	FD-18	144
DB-182	246	DL-1	53	DL-97	45	DP-102	109, 326	FD-19	141
				DL-98	60	DP-103	109, 326	FD-20	144

FD-21	146	FG-20	94	FK-75	235	FL-59	202	FL-389	207
FD-22	144	FG-21	90	FK-76	235	FL-60	202	FL-390	207
FD-22A	144	FG-22	90	FK-77	235	FL-61	202	FL-391	206
FD-23	146	FG-23	88	FK-78	235	FL-65	211	FL-392	206
FD-24	142	FG-24	88	FK-83	234	FL-66	211	FL-393	206
FD-25	145	FG-28	89	FK-84	234	FL-67	211	FL-394	206
FD-26	141	FG-36	90	FK-87	92	FL-68	211	FL-395	206
FD-28	144	FG-37	90	FK-88	92	FL-69	211	FL-396	207
FD-29	145	FG-38	95	FK-100	205	FL-70	211	FL-397	207
FD-30	145	FG-39	95	FK-101	205	FL-71	211	FL-398	207
FD-31	143	FG-50	93	FK-102	205	FL-72	211	FL-399	207
FD-32	145	FG-51	93	FK-103	205	FL-73	211	FL-400	206
FD-33	148	FG-52	93	FK-104	205	FL-74	211	FL-400M	207
FD-34	143	FG-53	93	FK-105	205	FL-75	211	FL-411	202
FD-35	148	FG-54	93	FK-106	205	FL-76	211	FL-412	202
FD-36	143	FG-55	93	FK-107	205	FL-77	211	FL-413	202
FD-37	143	FG-58	87	FK-108	205	FL-78	211	FL-414	202
FD-38	148	FG-59	86	FK-109	205	FL-79	211	FL-415	202
FD-41	83	FG-60	98	FK-110	236	FL-80	211	FL-416	202
FD-42	83	FG-61	98	FK-111	236	FL-104	203		
FD-64	83	FG-66	93	FK-112	236	FL-114	200	FLAGG	120
FD-65	83	FG-67	93	FK-113	236	FL-115	200		
FD-137	83	FG-92	106	FK-114	236	FL-116	200	FLOHR-1	52
FD-138	83	FG-98	106	FK-115	236	FL-120	208	FLOHR-2	52
FD-145	84	FG-101	90	FK-116	236	FL-121	208	FLOHR-3	52
FD-170	145	FG-102	90	FK-120	236	FL-122	208		
FD-171	145	FG-103	88	FK-121	236	FL-123	208	FM-1	98
FD-172	143	FG-104	88	FK-122	236	FL-124	208	FM-1F	98
FD-173	143	FG-105	88	FK-123	236	FL-125	208	FM-1SC	104
FD-182	84	FG-112	86	FK-124	236	FL-128	203	FM-2	98
FD-183	84	FG-113	86	FK-125	236	FL-132	200	FM-2F	98
FD-216	142	FG-121	91	FK-126	236	FL-135	200	FM-2SC	104
FD-217	142	FG-123	87	FK-136	234	FL-136	200	FM-3	99
FD-224	84	FG-124	87	FK-137	234	FL-141	210	FM-3F	99
FD-225	84	FG-147	89	FK-138	234	FL-142	210	FM-3SC	104
FD-236	142	FG-148	89	FK-139	234	FL-143	210	FM-4	99
FD-237	142	FG-153	106	FK-188	234	FL-144	210	FM-4F	99
FD-562T	147	FG-154	106	FK-189	234	FL-150	213	FM-4SC	104
FD-563T	147	FG-156	87	FK-197	234	FL-151	213	FM-5	96
FD-574T	147	FG-157	87	FK-198	234	FL-152	213	FM-5SC	104
FD-575T	147	FG-158	87			FL-153	213	FM-6	96
FD-587T	147	FG-159	87	FL-01	203	FL-155	213	FM-6SC	104
FD-588T	147	FG-160	107, 325	FL-03	201	FL-156	213	FM-7	96
FD-599	146	FG-161	325	FL-04	201	FL-157	213	FM-8	96
FD-600	146	FG-167	101	FL-05	201	FL-158	213	FM-9	96
FD-601	146	FG-168	101	FL-09	203	FL-159	213	FM-10	96
FD-602	146	FG-190	91	FL-09R	203	FL-177	201	FM-12	89
		FG-191	91	FL-10M	203	FL-179	201	FM-27	96
FE-1	273	FG-207	85	FL-11	203	FL-181	201	FM-28	96
FE-2	273	FG-208	85	FL-11R	203	FL-183	201	FM-41	96
FE-3	273	FG-209	85	FL-12	203	FL-184	201	FM-42	96
FE-4	273	FG-210	85	FL-12R	203	FL-185	201	FM-47	98
FE-4/5	273	FG-211	85	FL-13	201	FL-186	201	FM-48	98
FE-5	273	FG-212	85	FL-14	201	FL-187	201	FM-49	96
FE-6	273	FG-216	85	FL-15	201	FL-188	201	FM-51	107
				FL-16	199	FL-189	201	FM-59	107
FG-1	86	FK-1	92	FL-17	199	FL-230	202	FM-63	96
FG-1SC	104	FK-1SC	102	FL-18	199	FL-231	202	FM-66	99
FG-1SCZ	104	FK-1TC	102	FL-20	216	FL-232	202	FM-67	99
FG-1TC	101	FK-2	92	FL-21	216	FL-263	199	FM-68	99
FG-2	86	FK-2SC	102	FL-25	212	FL-264	199	FM-69	99
FG-2SC	104	FK-2TC	102	FL-26	212	FL-265	199	FM-79	95
FG-2SCZ	104	FK-60	236	FL-27	212	FL-266	199	FM-96	100
FG-2TC	101	FK-61	236	FL-28	212	FL-267	199	FM-97	100
FG-3	87	FK-62	236	FL-31	216	FL-268	199	FM-98	100
FG-4	86	FK-63	236	FL-32	199	FL-269	199	FM-99	100
FG-5	86	FK-64	236	FL-33	216	FL-292	209	FM-100	103
FG-11L	86	FK-65	236	FL-35	216	FL-293	209	FM-100L	103
FG-12L	86	FK-66	236	FL-37	212	FL-294	209	FM-102	103
FG-13	88	FK-67	236	FL-38	212	FL-295	209	FM-104	103
FG-14	89	FK-70	235	FL-39	212	FL-296	209	FM-109	89
FG-15	88	FK-71	235	FL-53	199	FL-297	209	FM-118	101
FG-19C	93	FK-72	235	FL-54	199	FL-298	209	FM-119	101
FG-19R	93	FK-73	235	FL-58	199	FL-299	209	FM-126	89



FM-127	89	G-14	258	GF-185	320	I-73	19	LA-8	67
FM-146	107	G-16	258	GF-188	320	I-74	18	LA-9	67
FM-180	95	G-18	258	GF-200	320, 357	I-74N	18	LA-10	67
FM-181	95	G-20	258	GF-240	318	I-79	20	LA-11	68
FM-201	100	G-22	258	GF-241	318	I-79N	20	LA-12	68
FM-202	100	G-24	258	GF-242	318	I-86C	19	LA-13	68
FM-203	100	G-26	258	GF-242B	318	I-87	20	LA-16	68
FM-204	100	G-28	258	GF-243	318	I-133L	23	LA-17	68
FM-298	97	G-30	258	GF-244	318	I-133R	23	LA-20	69
FM-299	97			GF-271	317	I-333S	23	LA-21	69
FM-300	97	GA-17	215					LA-22	69
FM-301	97	GA-18	215	GFC	91	IM-15	214	LA-23	69
FM-317	101	GA-19	215	GFC-S	91				
FM-318	97	GA-20	215	GFC-SC	105	KE-20	196	LB-10	77
FM-319	97	GA-33	213	GFC-TC	106	KE-40	196	LB-11	77
FM-339	106	GA-34	213					LB-12	77
FM-350	101	GA-35	213	GFR	91	KKD-1	287	LB-12D	77
		GA-36	213	GFR-S	91	KKD-2	287	LB-13	77
FO-08	242	GA-37	213	GFR-SC	105	KKD-4	287	LB-15	77
FO-09	242	GA-60	213	GFR-TC	106			LB-15A	77
FO-15	242	GA-63	213			KN-55	200	LB-15C	77
FO-16	244	GA-64	213	GFS	94	KN-75	200	LB-18	78
FO-17	242	GA-65	213	GFS-SC	105			LB-20	78
FO-18	243	GA-66	213			KO-1	224	LB-21	78
FO-19	242	GA-70	216	GO-1	273	KO-2	224	LB-23	78
FO-20	244	GA-71	217	GO-2	273	KO-3	224	LB-40	75
FO-21	242	GA-73	217	GO-3	273	KO-11	227	LB-361	75
FO-22	241	GA-78	217	GO-4	273	KO-20	228	LB-362	75
FO-23	241	GA-79	217			KO-22	224	LB-363	75
FO-24	241	GA-80	216	GS-02	358	KO-23	224	LB-364	75
FO-25	243	GA-81	216	GS-03	358	KO-58	226	LB-365	75
FO-26	245	GA-85	216	GS-04	358	KO-66	227	LB-366	75
FO-33	246	GA-86	216	GS-06	358			LB-367	75
FO-34	244	GA-90	216	GS-10	358	L-0	72	LB-368	75
FO-43	243	GA-91	216	GS-13	358	L-1	72	LB-369	75
FO-60	245			GS-16	78	L-2	72		
FO-61	245	GB-2	78	GS-18	78	L-3	72	LC-1	345
FO-77	245	GB-4	76	GS-26	109	L-4	72	LC-2	345
FO-85	241			GS-40	357	L-5	72	LC-3	345
FO-87	241	GF-01	317	GS-42	357	L-6	72		
FO-88	241	GF-02	317	GS-44	357	L-7	72	LG-1	94
FO-89	241	GF-03	317	GS-48	357	L-8	72	LG-1SC	105
FO-130	220	GF-04	317	GS-52	357	L-9	72	LG-2SC	105
FO-131	220	GF-05	317			L-11	72	LG-6	94
FO-131S	220	GF-06	315	H4422	345	L-21	72		
FO-138	244	GF-07	315			L-22	72	LK-1	90
FO-139	244	GF-10	315	H-1	275	L-23	72	LK-2	92
FO-156	244	GF-11	317	H-2	275	L-24	72	LK-3	90
FO-157	244	GF-12	315	H-3	275	L-25	72	LK-4	92
FO-159	220	GF-13	316			L-26	72	LK-10	102
FO-162	246	GF-14	316	HA	346	L-27	72	LK-12	102
FO-163	246	GF-15	316	HB	228, 345	L-28	72		
FO-165	246	GF-16	316	HC	345	L-29	72	LS-08	218
FO-216	242	GF-20	316	HE-1	47	L-51	71	LS-09	218
FO-220	241	GF-30	316	HE-2	47	L-52	71		
FO-221	242	GF-31	316	HE-3	47	L-53	71	LX-50	240
FO-229	243	GF-32	316	HF-3/7	267	L-54	71	LX-52	240
FO-230	243	GF-33	316	HF-5/11	267	L-55	71	LX-60	240
FO-231	245	GF-34	316	HF-9/10	267	L-56	71	LX-84	323
FO-232	245	GF-35	316	HL	346	L-57	71	LX-85	323
FO-233	245	GF-40	320	HP-6	58	L-58	71	LX-87	323
FO-234	245	GF-41	319	HR	345	L-59	71	LX-101	324
		GF-42	319	HV	345	L-60	71	LX-102	325
FR-16	204	GF-54	315			L-71	71	LX-103	325
FR-17	204	GF-60	319	I-13	19	L-72	71	LX-113	220
		GF-61	319	I-22 1/2L	22	L-73	71		
FREER	204, 226	GF-69	319	I-22 1/2R	22			MA-1	257
		GF-70	319			LA-1	66	MA-2	257
G-3	257	GF-133	214	I-36	18	LA-2	66	MA-3	257
G-4	257	GF-134	214	I-36N	18	LA-3	66	MA-6	258
G-5	257	GF-180	318	I-46L	21	LA-4	66	MA-7	257
G-8	258	GF-182	320	I-46LX	21	LA-5	66	MA-8	71
G-10	258	GF-183	320	I-46N	20	LA-6	66	MA-9	71
G-12	258	GF-184	318	I-59	19	LA-7	67	MA-9R	71

MA-B1	77	MIR-08	229	OL-1	278			P-120	168
MA-B2	77			OL-2	278	OS-1	280	P-121	168
MA-B3	77	MO-2	237	OL-3	278	OS-2	280	P-129	174
MA-B3M	77	MO-4	237					P-135	169
MA-B4	78	MO-4L	237	OM-2	280	OSB-1	286	P-136	171
MA-B7	77	MO-8	229	OM-04	195	OSB-2	286	P-137	171
MA-B7K	77	MO-9A	226	OM-06	186	OSB-4	285	P-215	171
MA-B8	77	MO-10	231, 237	OM-07	195	OSB-4A	285	P-216	171
MA-B9	77	MO-12	231	OM-08	186			P-217	171
MA-B16	76	MO-15	225	OM-10	195	OT-1	271	P-230	173
		MO-20	227	OM-16	195	OT-2	271	P-231	173
MC-11	71	MO-24	227	OM-18	195	OT-3	271	P-232	173
MC-12	71			OM-19	195	OT-4	271	P-233	173
MC-13	71	MOLT-9	226	OM-30	195	OT-5	271	P-238	173
MC-70	71			OM-40	188	OT-6	271	P-239	173
		MPI-1	214	OM-40R	188	OT-7	271	P-240	173
MD-1	35			OM-41	188	OT-8	271	P-241	173
MD-2	35	MRT/C7	336	OM-41R	188	OT-9	271	P-250	171
MD-3	35	MRT-6	336	OM-42	188	OT-10	271	P-251	171
MD-4	35	MRT-7	336	OM-44	195	OT-11	272	P-252	171
		MRT-C1	337	OM-45	195	OT-12	272	P-253	171
MERIAM	120	MRT-C3	337	OM-50	191	OT-13	272	P-256	171
		MRT-C4	337	OM-52	191	OT-14	272	P-257	171
MF-101	129			OM-55	191	OT-15	272	P-260	171
MF-101T	118	NK-1	76	OM-55B	191	OT-16	272	P-261	171
MF-102	129	NK-2	76	OM-60	188			P-264	168
MF-102T	118	NK-3	76	OM-61	191	OX-1	280	P-265	168
MF-103	129	NK-06	79	OM-62	188	OX-2	280	P-266	168
MF-104	129	NK-07	79	OM-66	191	OX-3	280	P-267	168
MF-105	129	NK-08	79	OM-66B	191			P-324	174
MF-106	136	NK-09	79	OM-67	191	OZ-1	278	P-332	168
MF-107	136	NK-10	79	OM-70	196	OZ-2	278	P-340	219
MF-110	115	NK-11	79	OM-71	196	OZ-3	278	P-341	219
MF-111	115	NK-12	75	OM-72	196			P-342	219
MF-112	115	NK-14	79	OM-74	189	P-0	258		
MF-113	115	NK-16	79	OM-75	189	P-00	258	PEB-1	37
MF-114	115	NK-17	79	OM-76	189	P-000	258	PEB-2	37
MF-115	115	NK-18	79	OM-77	189	P-01	258	PEB-3	37
MF-124	119	NK-20	79	OM-80	185	P-02	258	PEB-4	37
MF-125	119	NK-30	80	OM-81	185	P-03	258	PEB-5	37
MF-126	119	NK-32	80	OM-82	185	P-3	257	PEB-6	37
MF-127	119	NK-34	80	OM-85	185	P-04	258	PEB-7	37
MF-128	119	NK-36	80	OM-87	185	P-4	257	PEB-17S	36
MF-129	119	NK-38	80	OM-88	185	P-05	258	PEB-23S	36
MF-142T	119	NK-39	79	OM-90	189	P-5	257	PEB-150S	36
MF-143T	119	NK-40	80	OM-97	189	P-06	258	PEB-151S	36
MF-144T	119	NK-105	204	OM-100	185	P-15	169		
MF-145T	119	NK-249	204	OM-110	193	P-49	172	PF-1	328
MF-146T	119	NK-251	204	OM-112	193	P-50	174	PF-2	328
MF-147T	119			OM-113	193	P-52	174	PF-3	328
MF-177	114	O-1	277	OM-114	193	P-61	173	PF-6	214, 256
MF-249	114	O-2	277	OM-136	193	P-62	173	PF-9	268
MF-370	116	O-3	277	OM-137	193	P-63	173	PF-40	256
MF-371	116	O-4	277	OM-138	193	P-64	173	PF-41	256
MF-372	116			OM-139	193	P-79	172		
MF-373	116	OA-1	279			P-81	172	PH-37	149
MF-374	116	OA-2	279	ON-1	280	P-82	172	PH-38	149
MF-375	116	OA-3	279			P-84	172	PH-39	149
MF-376	116			OP-1	279	P-85	172	PH-40	159
MF-377	116	OBN-1	287	OP-2	279	P-86	172	PH-41	159
MF-378	117	OBN-2	287	OP-3	279	P-87	172	PH-42	159
MF-379	117	OBN-4	287	OP-4	279	P-89	172	PH-48	149
MF-380	117			OP-5	279	P-91	170	PH-53	153
MF-381	117	OC-1	278	OP-7	216	P-92	170	PH-54	156
MF-382	117	OC-2	278	OP-8	216	P-93	170	PH-58	155, 325
MF-383	117					P-94	170	PH-59	155
MF-384	117	OF-1	285	OR-11	218	P-95	170	PH-60	336
MF-385	117	OF-2	285	OR-12	218	P-96	170, 329	PH-61	149
		OF-3	285	OR-13	218	P-97	170, 329	PH-62	149
MI-10	55			OR-14	218	P-98	170	PH-63	149
MI-11	55	OK-1	277	OR-18	218	P-100	174	PH-64	149
MI-12	55	OK-2	277	OR-19	218	P-101	169	PH-65	153
MI-13	55	OK-3	277	OR-40	218	P-102	169	PH-66	153
				OR-45	218	P-115	174	PH-67	153



PH-68	153	PO-80	160	SC-13	108	SS-50	269	USG-5/6L	264
PH-69	153	PO-81	160	SC-14	108	SS-51	269	USG-5/6S	263
PH-70	159	PO-82	158	SC-15	108	SS-52	269	USG-7/8	263
PH-71	156	PO-84	158	SC-16	108	SS-54	269	USG-7/8ET	262
PH-72	155	PO-85	158			SS-55	269	USG-7/8L	264
PH-73	153	PO-86	158	SD-1	260	SS-56	269	USG-7/8S	263
PH-74	159	PO-87	158	SD-2	260	SS-58	269	USG-9/10	263
PH-75	155	PO-88	158	SD-3	260	SS-60M	215	USG-9/10ET	262
PH-76	155	PO-94	158	SD-3R	260	SS-61M	215	USG-9/10L	264
PH-77	155	PO-99	157	SD-7	259	SS-62M	215	USG-9/10S	263
PH-79	152	PO-99L	157	SD-7R	259	SS-64M	215	USG-11/12	263
PH-80	151	PO-104	157	SD-20	259	SS-65	214, 270	USG-11/12ET	262
PH-81	151	PO-105	157	SD-M	72			USG-11/12L	264
PH-82	151					STF-1	260	USG-11/12S	263
PH-83	151	PR-3	226	SE-2	58	STF-1R	260	USG-13/14	263
PH-84	151	PR-3A	226	SE-4L	58			USG-13/14ET	262
PH-85	152			SE-4R	58	TG-10	199	USG-13/14L	264
PH-90	156	PS-1	346			TG-11	199	USG-13/14S	263
PH-99	156	PS-2	346	SIL-01	351	TG-12	199	USG-15/16	264
PH-100	156			SIL-02	351	TG-15	200	USG-15/16ET	262
PH-101	154	PT-1	342	SIL-03	351	TG-17A	352	USG-17/18S	264
PH-102	154	PT-2	342	SIL-04	351	TG-17B	352	USG-KN1/26	264
PH-103	154	PT-3	342	SIL-05	351	TG-17C	352		
PH-106	152	PT-4	342			TG-17G	352	USS-5/6LAN	266
PH-110	154	PT-5	342	SL-1	231	TG-17R	352	USS-5/33	265
PH-111	154			SL-2	231	TG-17V	352	USS-15/30	265
PH-120	154	PZ-1	254	SL-21	233	TG-17Y	352	USS-15/33	265
PH-121	154	PZ-2	254			TG-20	199	USS-204S	265
PH-122	154	PZ-3	254	SM-1	253	TG-21	199	USS-H6/7	265
PH-127	154	PZ-4	254	SM-2	253	TG-22	199	USS-J14/15	265
PH-128	154			SM-3	253	TG-23	199	USS-KRA1	264
PH-129	154	R-1	275	SM-4	253	TG-30	200	USS-KRA3	264
PH-132	155	R-2	275	SM-5	253	TG-31	200	USS-MC11/12	266
PH-133	155	R-3	275	SM-6	253	TG-32	200	USS-MC13/14	266
PH-134	155			SM-11	251			USS-MC13/14S	266
PH-140	148	RH-4	257	SM-12	251	T-I	354 355	USS-MC17/18S	266
PH-141	148	RH-5	257	SM-13	251	T-IF	354 355	USS-NV0	265
PH-142	148	RH-14	257	SM-15	251			USS-NV11/12	265
				SM-19	251	TP-8A	353	USS-NV13/14	265
PL-1	254	RO-1	39	SM-20	252	TP-8B	353	USS-T2/3	265
PL-2	254			SM-21	251	TP-8C	353		
PL-3	254	S18-8	340	SM-22	252	TP-8G	353	VS-20	350
PL-4	254	S-0	274			TP-8R	353	VS-26	350
		S-00	274	SO-1	249	TP-8V	353	VS-30	350
PM-1	282	S-1	274	SO-2	249	TP-8Y	353		
PM-2	282	S-2	274	SO-3	249			WG-10	223
PM-3	282	S-3	274	SO-4	249	TS-1	283	WG-12	223
PM-4	282	S-3AN	13	SO-5	249	TS-2	283	WG-14	223
PM-5	282	S-4	274	SO-6	249	TS-3	283		
PM-6	282	S-7	13	SO-7	250	TS-4	283	Z-1	346
		S-31	14	SO-8	250	TS-40	317	Z-2	346
PO-37	159	S-34	13	SO-9	250	TS-50	317	Z-3	346
PO-38	159	S-35	13	SO-10	250	TS-101	350		
PO-40	160	S-49	17	SO-11	250	TS-102	350		
PO-45	161	S-51B	16	SO-12	250	TS-103	350		
PO-46	160	S-51LX	17	SO-20	252	TS-104	350		
PO-47	160	S-66L	14						
PO-48	160	S-66R	14	SP-1	255	TT-01	118		
PO-50	158	S-67L	15	SP-2	255			USC-2	276
PO-51	158	S-67N	15	SP-3	255	USC-2RL	266	USC-4RL	266
PO-52	158	S-67R	15	SP-4	255	USC-13/14	266		
PO-55	158	S-80	16	SP-5	255			USG-1/2	263
PO-56	158	S-97	16	SP-6	255	USG-1/2ET	262	USG-1/2L	264
PO-59	150	S-97B	16	SP-7	255	USG-1/2S	263	USG-3/4	263
PO-60	161	S-351S	17			USG-3/4ET	262	USG-3/4L	264
PO-61	161			SR	274	USG-3/4S	263	USG-5/6	263
PO-65	160	SA-1	340			USG-5/6ET	262		
PO-68	161	SA-2	340	SS-15	270				
PO-69	161	SA-3	340	SS-16	270				
PO-71	161			SS-20	216				
PO-76	161	SC-1	108	SS-21	216				
PO-77	161	SC-2	108	SS-22	216				
PO-78	160	SC-5	108	SS-41	270				
PO-79	160	SC-9	108	SS-42	270				



Bontempi

SURGICAL INSTRUMENTS
PORTUGAL

Passion for Excellence

Rua Poeta de Bocage, nº 15-F, Letra J
1600-240 Lisboa
T: + 351 210 968 925
F: + 351 210 968 925

info@bontempiportugal.pt
www.bontempiportugal.pt